

www.datasheet4u.com

MN4584B / MN4584BS

Hex Schmitt Triggers

■ Description

The MN4584B/S have hex waveform shaping circuits. They are used when high noise immunity is desired, and as waveform-shaping circuits to make late rise and fall time input. The MN4584B/S are equivalent to MOTOROLA MC14584B.

■ Logic Diagram (1/6)

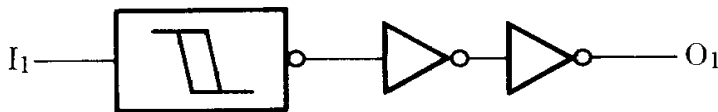

P- 1

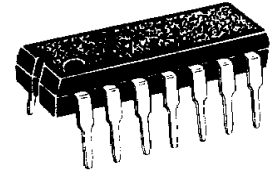

14-Pin • Plastic DIL Package

P- 2

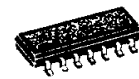

14-Pin • Panafat Package (SO-14D)

Pin Configuration

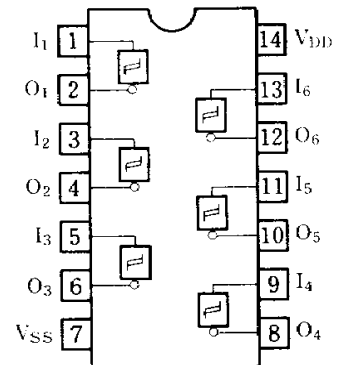

■ Maximum Ratings (Ta=25°C)

Item	Symbol	Ratings	Unit
Supply Voltage	V_{DD}	-0.5 ~ +18	V
Input Voltage	V_I	-0.5 ~ $V_{DD} + 0.5^*$	V
Output Voltage	V_O	-0.5 ~ $V_{DD} + 0.5^*$	V
Peak Input · Output Current	$\pm I_I$	max. 10	mA
Power Dissipation (per package)	P_D	max. 400	mW
		Decrease up to 200mW rating at 8mW/°C	
Power Dissipation (per output terminal)	P_D	max. 100	mW
Operating Ambient Temperature	T_{opr}	-40 ~ +85	°C
Storage Temperature	T_{stg}	-65 ~ +150	°C

* $V_{DD} + 0.5V$ should be under 18V

www.datasheet4u.com

■ DC Characteristics (V_{SS}=0V)

Item	V _{DD} (V)	Symbol	Conditions	Ta = -40°C		Ta = 25°C		Ta = 85°C		Unit
				min.	max.	min.	max.	min.	max.	
Quiescent Power Supply Current	5	I _{DD}	V _i =V _{SS} or V _{DD}	—	1	—	1	—	7.5	μA
	10			—	2	—	2	—	15	
	15			—	4	—	4	—	30	
Output Voltage Low Level	5	V _{OL}	V _i =V _{SS} or V _{DD} I _o < 1μA	—	0.05	—	0.05	—	0.05	V
	10			—	0.05	—	0.05	—	0.05	
	15			—	0.05	—	0.05	—	0.05	
Output Voltage High Level	5	V _{OH}	V _i =V _{SS} or V _{DD} I _o < 1μA	4.95	—	4.95	—	4.95	—	V
	10			9.95	—	9.95	—	9.95	—	
	15			14.95	—	14.95	—	14.95	—	
Input Voltage Low Level	5	V _{IL}	I _o < 1μA V _o =0.5V or 4.5V	—	1.5	—	1.5	—	1.5	V
	10			—	3	—	3	—	3	
	15			—	4	—	4	—	4	
Input Voltage High Level	5	V _{IH}	I _o < 1μA V _o =0.5V or 4.5V	3.5	—	3.5	—	3.5	—	V
	10			7	—	7	—	7	—	
	15			11	—	11	—	11	—	
Output Current Low Level	5	I _{oL}	V _o =0.4V, V _i =0 or 5V	0.52	—	0.44	—	0.36	—	mA
	10			1.3	—	1.1	—	0.9	—	
	15			3.6	—	3	—	2.4	—	
Output Current High Level	5	-I _{oH}	V _o =4.6V, V _i =0 or 5V	0.52	—	0.44	—	0.36	—	mA
	10			1.3	—	1.1	—	0.9	—	
	15			3.6	—	3	—	2.4	—	
Output Current High Level	5	-I _{oH}	V _o =2.5V, V _i =0 or 5V	1.7	—	1.4	—	1.1	—	mA
Input Leakage Current	15	±I _I	V _i =0 or 15V	—	0.3	—	0.3	—	1	μA

■ Switching Characteristics (Ta = 25°C, V_{SS}=0V, C_L=50pF)

Item	V _{DD} (V)	Symbol	min.	typ.	max.	Unit
Output Rise Time (Fig. 1)	5	t _{TLH}	—	60	180	ns
	10		—	30	90	
	15		—	20	60	
Output Fall Time (Fig. 1)	5	t _{THL}	—	60	180	ns
	10		—	30	90	
	15		—	20	60	
Propagation Delay Time (Fig. 1)	5	t _{PLH}	—	75	225	ns
	10		—	35	105	
	15		—	30	90	
Propagation Delay Time (Fig. 1)	5	t _{PHL}	—	90	270	ns
	10		—	35	105	
	15		—	30	90	
Threshold Voltage (Fig. 2)	5	V _{IH}	—	3.0	3.5	V
	10		—	5.8	7	
	15		—	8.3	11	

www.datasheet4u.com

■ Switching Characteristics ($T_a = 25^\circ\text{C}$, $V_{SS} = 0\text{V}$, $C_L = 50\text{pF}$) (continued)

Item	V_{DD} (V)	Symbol	min.	typ.	max.	Unit
Threshold Voltage (Fig. 2)	5	V_{IL}	1.5	2.2	—	V
	10		3	4.5	—	
	15		4	6.5	—	
Hysteresis Voltage (Fig. 2)	5	V_H	0.5	0.8	—	V
	10		0.7	1.3	—	
	15		0.9	1.8	—	
Input Capacitance		C_i	—	—	7.5	pF

Fig. 1 Switching Time Test Circuit and Waveforms

1. Test Circuit

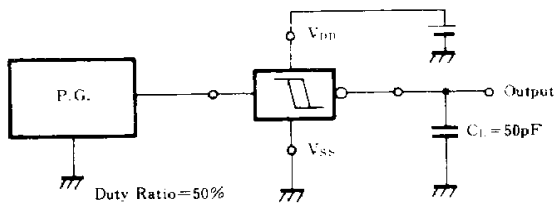

2. Waveforms

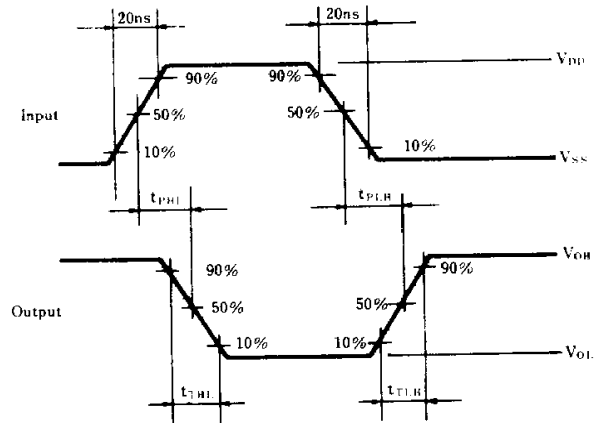
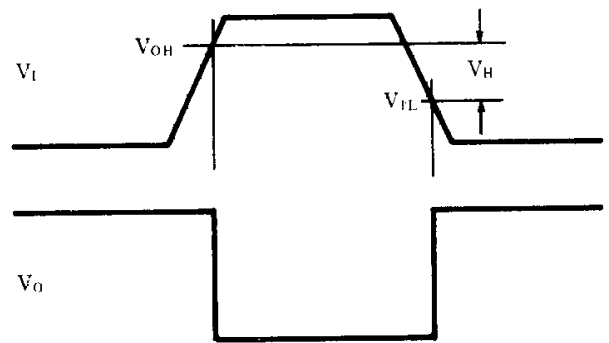
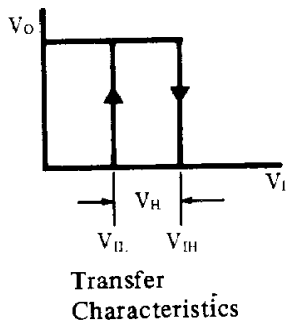

Fig. 2 Transfer Characteristics



The waveform illustrated above shows its definition rating 30%, to 70% limit.