

Schematic:

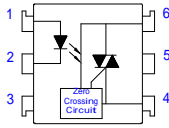

For dimensions and pin-outs, see the last page of this document.

Features:

1. Compact dual-in-line package.
2. 600V peak blocking voltage.
3. Isolation voltage between input and output (Viso:5300Vrms).
4. 30 max trigger current

Ordering:

Suffix to Standard Part Number

- V = VDE Compliant
- G = 10mm Lead Spread
- S = Surface Mount Lead-form
- T = Tape & Reel

Superior OPTO Part Number:

OPTO630

Absolute Maximum Ratings:

(Ta=25°C)

Parameter		Symbol	Rating	Unit
Input	Forward current	IF	50	mA
	Peak forward current	IFM	1	A
	Reverse voltage	VR	6	V
	Power dissipation	PD	70	mW
Output	Off-State Output Terminal voltage	VDRM	600	Vpeak
	Peak Repetitive Surget Current	ITSM	1	A
	Power dissipation	PD	300	mW
Total power dissipation		Ptot	330	mW
Isolation voltage 1 minute		Viso	5300	Vrms
Operating temperature		Topr	-40 to +80	°C
Storage temperature		Tstg	-40 to +125	°C
Soldering temperature 10 seconds		Tsol	260	°C

Electrical Characteristics:

(Ta=25°C)

Parameter		Symbol	Conditions	MIN.	TYP.	MAX.	Unit
Input	Forward voltage	VF	IF =10mA	—	1.2	1.5	V
	Reverse Leakage Current	IR	VR =4V	—	—	10	UA
Output	Peak Blocking Current	IDRM	VDRM =Rated	—	60	500	nA
	ON-State Voltage	VTM	ITM =100mA	—	1.8	3	V
	Critical rate of rise of OFF-state voltage	dV/dt		600	—	—	V/uS
Transfer characteristics	Holding Current	IH		—	100	—	uA
	Inhibit Voltage (MT1-MT2 Voltage above which device not trigger.)	VINH	IF =10mA	—	5	20	V
	Leakage in Inhibited State	IDRM2	IF =Rated IFT, Rated VDRM, Off State	—	—	500	uA
	Isolation resistance	Riso	DC500V	5x10 ¹⁰	10 ¹¹	—	ohm
	Minimum trigger current	IFT	Main Terminal Voltage=3V	—	—	30	mA

Fig.1 Forward Current vs. Ambient Temperature

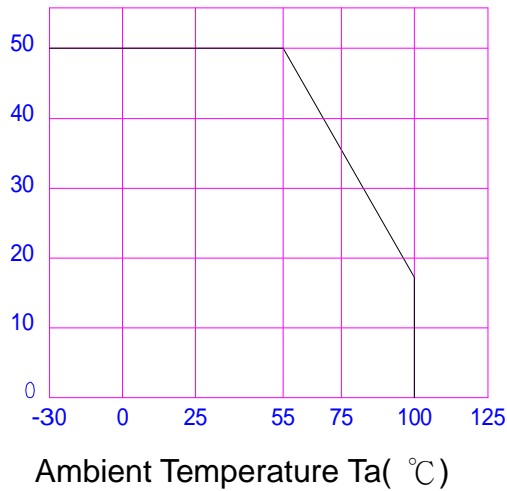

Fig.2 Diode Power Dissipation vs. Ambient Temperature

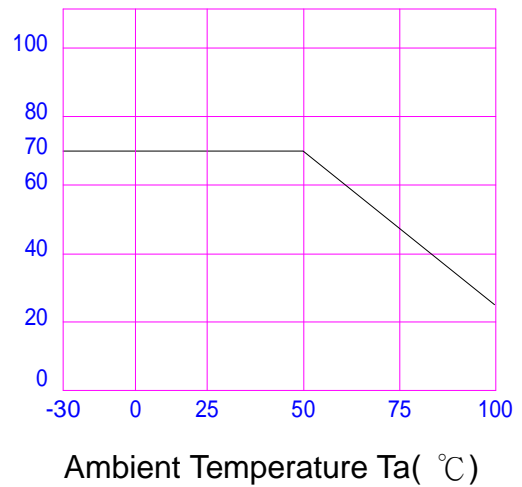

Fig.3 On-State R.M.S. Current vs. Ambient Temperature

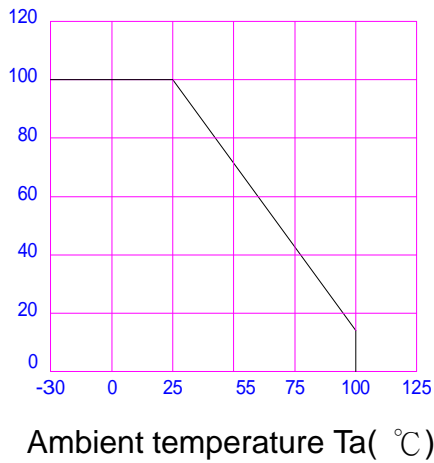

Fig.4 Total Power Dissipation vs. Ambient Temperature

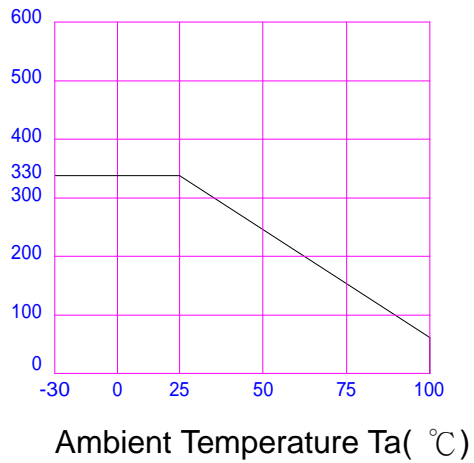

Fig.5 Peak Forward Current vs. Duty Ratio

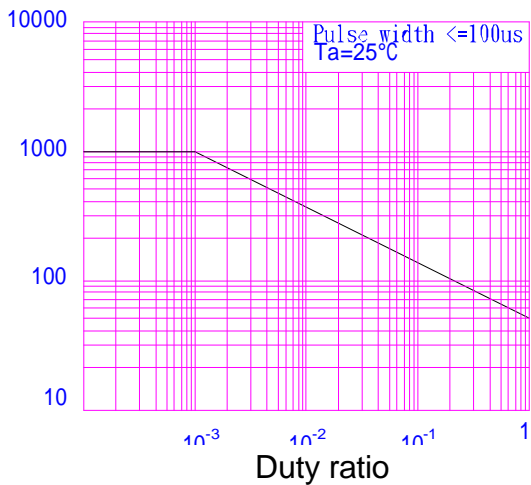

Fig.6 Forward Current vs. Forward Voltage

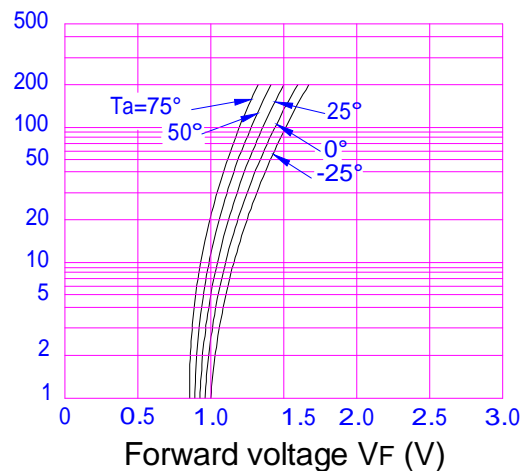

Fig.7 On-State Characteristics

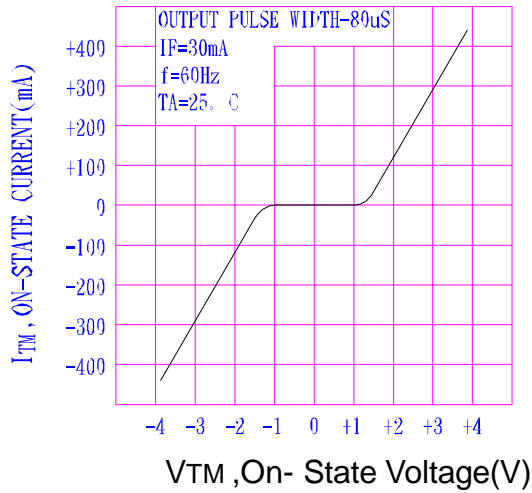

Fig.8 Inhibit Voltage vs. Temperature

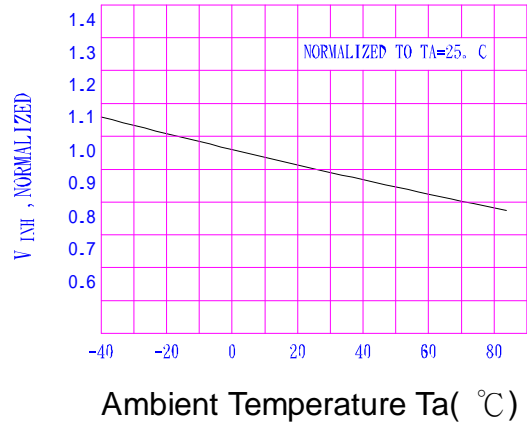

Fig.9 Leakage with LED Off vs. Temperature

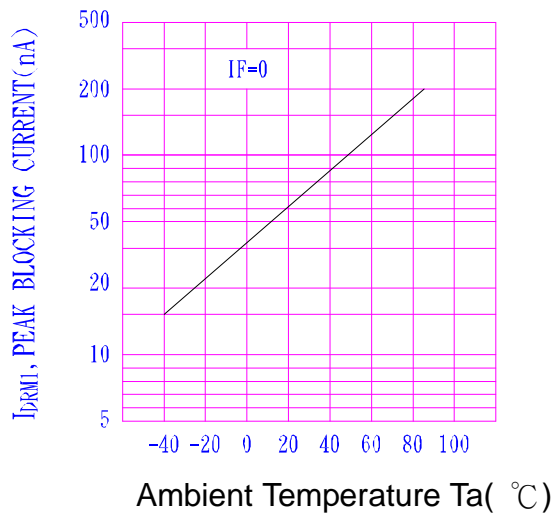

Fig.10 IDR M2 ,Leakage in Inhibit State vs. Temperature

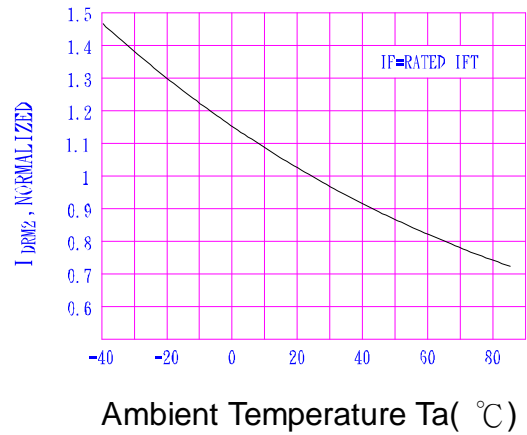

Fig.11 Trigger Current vs. Temperature

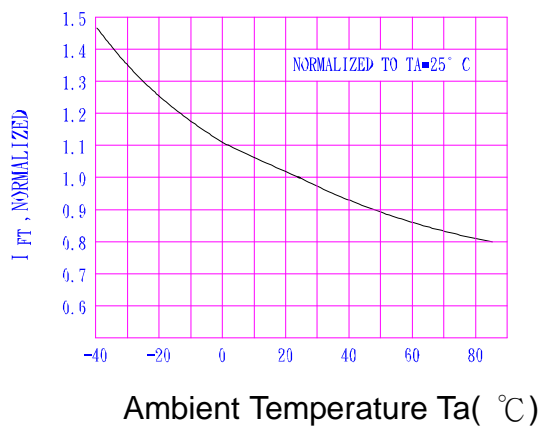

Fig.4 : 6-pin DIP type

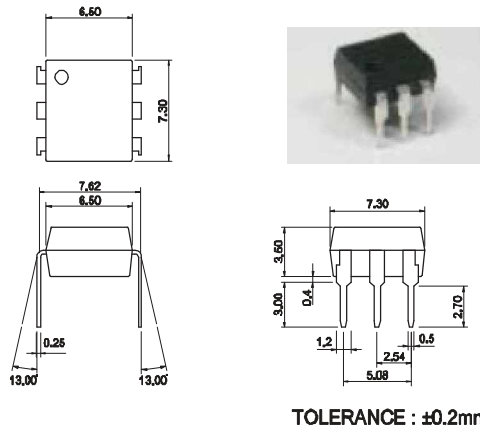

Fig.5 : 6-pin SMD type

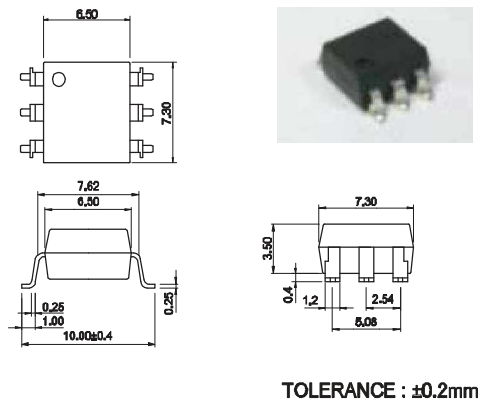

Fig.6 : 6-pin G type

