

Form 859-990514

Overview

In 1974, Opto 22 introduced the first liquid epoxy-filled line of power solid-state relays (SSR). This innovation in SSR design greatly improved the reliability and reduced the cost of manufacturing. At that time, we also incorporated into our manufacturing process 100% testing of every relay produced under full load conditions. By 1978, Opto 22 had

gained such a reputation for reliability that we were recognized as the world's leading manufacturer of solid-state relays. Through continuous manufacturing improvements and the same 100% testing policy established 22 years ago, Opto 22 is still recognized today for the very high quality and reliability of its complete line of solid-state relays.

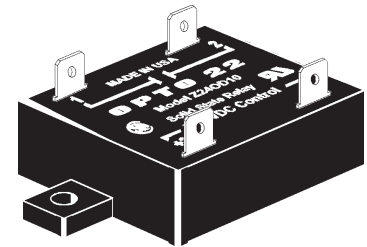
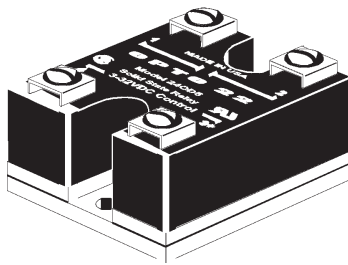

Index

Power Series

Z Series

Page	Description
1	Introduction
2	All Models: General Specifications
3	120/240 Volt AC Power Series: General Specifications
4	120/240 Volt AC Power Series: Surge Current Data, Thermal Data, and Dimensions
5	480/575 Volt AC Power Series: General Specifications
6	120/240 Volt AC Power Series Plastic Package (Z Series): General Specifications
7	AC Power Printed Circuit Series: General Specifications
8	DC Switching Series: General Specifications
APPLICATION TIPS	
9	Heat Sink Calculation, Duty Cycle Calculation
10	Transformer Loads, Solenoid Loads, and Lamp Loads
11	Solid-State Relays in Series, Lamp Loads, Heater Loads
12	Motor Loads

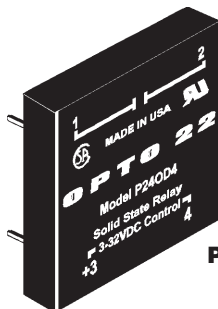

P Series

MP Series

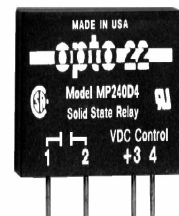

DATA SHEET

Form 859-990514

Specifications

All Models

- 4,000 V optical isolation input to output
- Zero voltage turn-on
- Turn-on time: ½ cycle maximum
- Turn-off time: ½ cycle maximum
- Operating frequency: 25 to 65 Hz (operates at 400 Hz with six times off-state leakage)
- Coupling capacitance input to output: 8 pF maximum
- DV/DT Off-state: 200 volts per microsecond
- DV/DT commutating: snubbed for rated current at 0.5 power factor
- UL recognized
- CSA certified
- CE component

DATA SHEET

Form 859-990514

Specifications

AC Power Series - 120/240 Volt

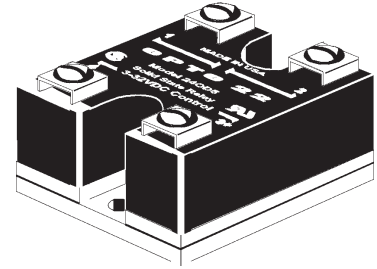

Opto 22 provides a full range of power series relays with a wide variety of voltage (110–575) and current options (3–45 amps). All Power Series relays feature 4,000 volts of optical isolation and have a high PRV rating.

Model Number	Nominal AC Line Voltage	Nominal Current Rating (Amps)	1 cycle Surge (Amps) Peak	Nominal Signal Input Resistance (Ohms)	Signal Pick-up Voltage	Signal Drop-out Voltage	Peak Repetitive Voltage Maximum	Maximum Output Voltage Drop	Off-State Leakage (mA) Maximum	Operating Voltage Range (Volts AC)	I _t Rating t=8.3 (ms)	Isolation Voltage	θ _{jc} * (°C/Watt)	Dissipation (Watt s/Amp)
120D3	120	3	85	1000	3VDC (32V allowed)	1 VDC	600	1.6 volts	2.5mA	12-140	30	4,000V _{RMS}	11	1.7
120D10	120	10	110	1000	3VDC (32V allowed)	1 VDC	600	1.6 volts	7 mA	12-140	50	4,000V _{RMS}	1.3	1.6
120D25	120	25	250	1000	3VDC (32V allowed)	1 VDC	600	1.6 volts	7 mA	12-140	250	4,000V _{RMS}	1.2	1.3
120D45	120	45	650	1000	3VDC (32V allowed)	1 VDC	600	1.6 volts	7 mA	12-140	1750	4,000V _{RMS}	0.67	0.9
240D3	240	3	85	1000	3VDC (32V allowed)	1 VDC	600	1.6 volts	5 mA	24-280	30	4,000V _{RMS}	11	1.7
240D10	240	10	110	1000	3VDC (32V allowed)	1 VDC	600	1.6 volts	14 mA	24-280	50	4,000V _{RMS}	1.3	1.6
240D25	240	25	250	1000	3VDC (32V allowed)	1 VDC	600	1.6 volts	14 mA	24-280	250	4,000V _{RMS}	1.2	1.3
240D45	240	45	650	1000	3VDC (32V allowed)	1 VDC	600	1.6 volts	14 mA	24-280	1750	4,000V _{RMS}	0.67	0.9
380D25	380	25	250	1000	3VDC (32V allowed)	1 VDC	800	1.6 volts	12 mA	24-420	250	4,000V _{RMS}	1.2	1.3
380D45	380	45	650	1000	3VDC (32V allowed)	1 VDC	800	1.6 volts	12 mA	24-420	1750	4,000V _{RMS}	0.67	0.9
120A10	120	10	110	33K	85 VAC (280 allowed)	10 VAC	600	1.6 volts	7 mA	12-140	50	4,000V _{RMS}	1.3	1.6
120A25	120	25	250	33K	85 VAC (280 allowed)	10 VAC	600	1.6 volts	7 mA	12-140	250	4,000V _{RMS}	1.2	1.3
240A10	240	10	110	33K	85 VAC (280 allowed)	10 VAC	600	1.6 volts	14 mA	24-280	50	4,000V _{RMS}	1.3	1.6
240A25	240	25	250	33K	85 VAC (280 allowed)	10 VAC	600	1.6 volts	14 mA	24-280	250	4,000V _{RMS}	1.2	1.3
240A45	240	45	650	33K	85 VAC (280 allowed)	10 VAC	600	1.6 volts	14 mA	24-280	1750	4,000V _{RMS}	0.67	0.9

Notes: θ_{jc}* = Thermal resistance junction to base. Maximum junction temperature is 110°C.

DATA SHEET

Form 859-990514

Specifications:

AC Power Series - 120/240 Volt (Continued)

Surge Current Data

Time (Seconds)	Time* (Cycles)	3-Amp Peak Amps	10-Amp Peak Amps	25-Amp Peak Amps	45-Amp Peak Amps
0.017	1	85	110	250	650
0.050	3	66	85	175	420
0.100	6	53	70	140	320
0.200	12	45	60	112	245
0.500	30	37	50	80	175
1	60	31	40	67	134
2	120	28	33	53	119
3	180	27	32	49	98
4	240	26	31	47	95
5	300	25	30	45	91
10	600	24	28	42	84

Note: *60 Hz.

Dimensional Drawings

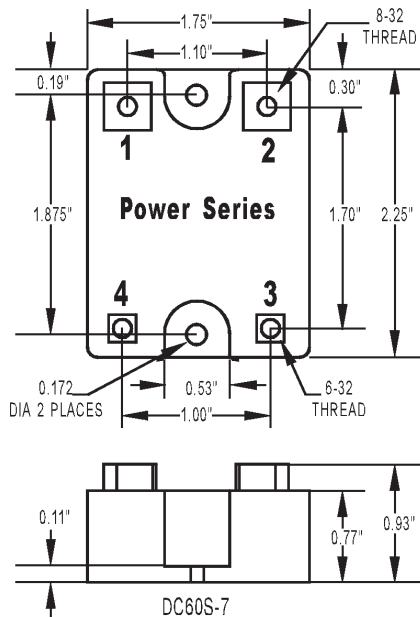

Thermal Ratings

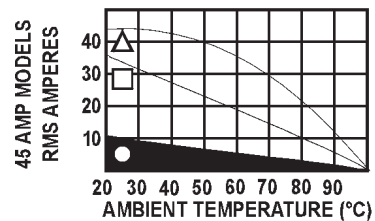
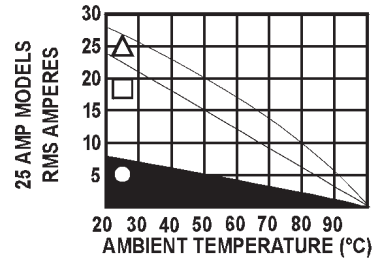
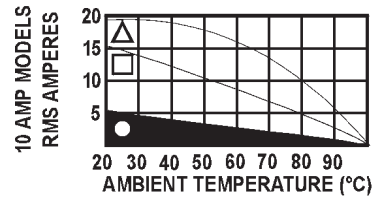
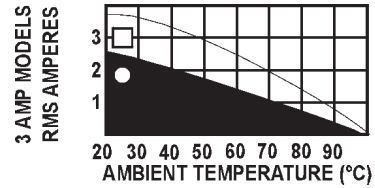

- FREE AIR
- MOUNTED ON 6" X 6" PLATE (2°c/watt)
- MOUNTED ON 12" X 12" PLATE (1°c/watt)

DATA SHEET

Form 859-990514

Specifications

AC Power Series - 480/575 Volt

DC SERIES: The DC Series delivers isolated DC control to large OEM customers worldwide.

AC SERIES: The AC Series offers the ultimate in solid-state reliability. All AC power series relays feature a built-in snubber and zero voltage turn-on. Transient proof models offer self-protection for noisy electrical environments.

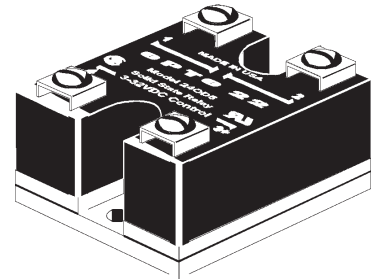

Model Number	Nominal AC Line Voltage	Nominal Current Rating (Amps)	1 cycle Surge (Amps) Peak	Nominal Signal Input Resistance (Ohms)	Signal Pick-up Voltage	Signal Drop-out Voltage	Peak Repetitive Voltage Maximum	Maximum Output Voltage Drop	Off-State Leakage (mA) Maximum	Operating Voltage Range (Volts AC)	I ² t Rating t=8.3 (ms)	Isolation Voltage	θ _{jc} * (°C/Watt)	Dissipation (Watts/Amp)
480D10-12	480	10	110	1000	3VDC (32V Allowed)	1 VDC	1200	3.2 volts	11 mA	100-530	50	4,000V _{RMS}	1.2	2.5
480D15-12	480	15	150	1000	3VDC (32V Allowed)	1 VDC	1200	3.2 volts	11 mA	100-530	50	4,000V _{RMS}	1.2	2.5
480D25-12	480	25	250	1000	3VDC (32V Allowed)	1 VDC	1000	1.6 volts	11 mA	100-530	250	4,000V _{RMS}	1.3	1.3
480D45-12	480	45	650	1000	3VDC (32V Allowed)	1 VDC	1000	1.6 volts	11 mA	100-530	1750	4,000V _{RMS}	0.67	0.9
575D15-12	575	15	150	1000	3VDC (32V Allowed)	1 VDC	1200	3.2 volts	15 mA	100-600	90	4,000V _{RMS}	1.2	2.5
575D45-12	575	45	650	1000	3VDC (32V Allowed)	1 VDC	1000	1.6 volts	15 mA	100-600	1750	4,000V _{RMS}	0.67	0.9

Note: θ_{jc}* = Thermal resistance junction to base. Maximum junction temperature is 110°C.

Surge Current Data

Time Second	Time*** (Cycles)	10-Amp Peak Amps	15-Amp Peak Amps	25-Amp Peak Amps	45-Amp Peak Amps
0.017	1	110	150	250	650
0.050	3	85	140	175	420
0.100	6	70	110	140	320
0.200	12	60	90	112	245
0.500	30	50	70	80	175
1	60	40	55	67	134
2	120	33	49	53	119
3	180	32	47	49	98
4	240	31	43	47	95
5	300	30	40	45	91
10	600	28	35	42	84

Note: ***60 Hz

Dimensional Drawings

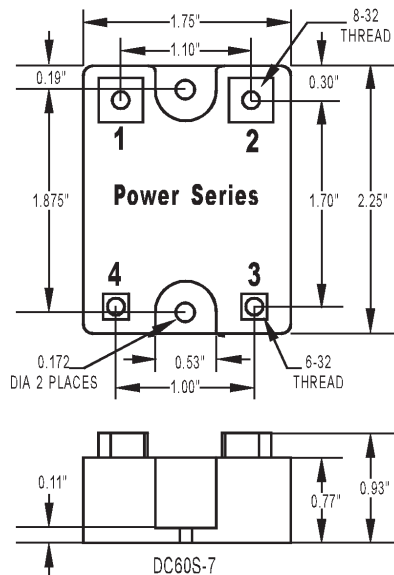

Thermal Ratings

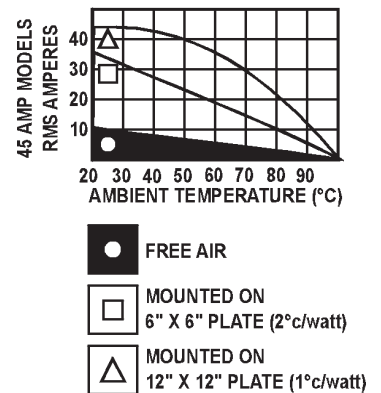

DATA SHEET

Form 859-990514

Specifications

AC Power Series - 120/240 Volt Plastic Package (z series)

The Z Series employs a unique heat transfer system that makes it possible for Opto 22 to deliver a low-cost, 10-amp, solid-state relay in an all-plastic case. The push-on tool-free quick-connect terminals make the Z Series ideal for high-volume OEM applications.

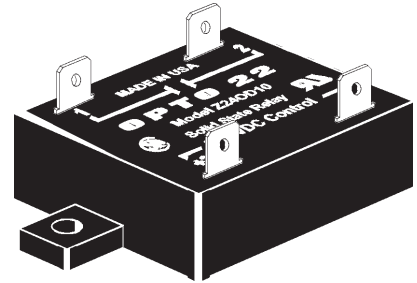

Model Number	Nominal AC Line Voltage	Nominal Current Rating (Amps)	1 cycle Surge (Amps) Peak	Nominal Signal Input Resistance (Ohms)	Signal Pick-up Voltage	Signal Drop-out Voltage	Peak Repetitive Voltage Maximum	Maximum Output Voltage Drop	Off-State Leakage (mA) Maximum	Operating Voltage Range (Volts AC)	I _t Rating t=8.3 (ms)	Isolation Voltage	θ _{jc} * (°C/Watt)	Dissipation (Watts/Amp)
Z120D10	120	10	110	1000	3VDC (32V allowed)	1 VDC	600	1.6 volts	6 mA	12-140	50	4,000 V _{RMS}	4	1
Z240D10	240	10	110	1000	3VDC (32V allowed)	1 VDC	600	1.6 volts	12 mA	24-280	50	4,000 V _{RMS}	4	1

Notes: θ_{jc}* = Thermal resistance junction to base. Maximum junction temperature is 110°C.

Dimensional Drawings

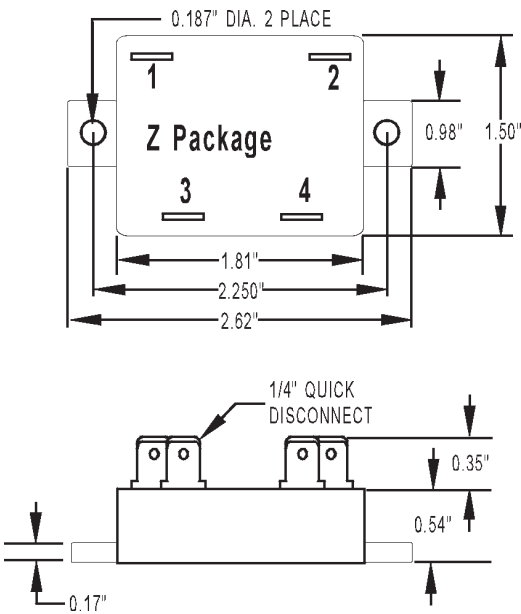

Current vs. Ambient Ratings

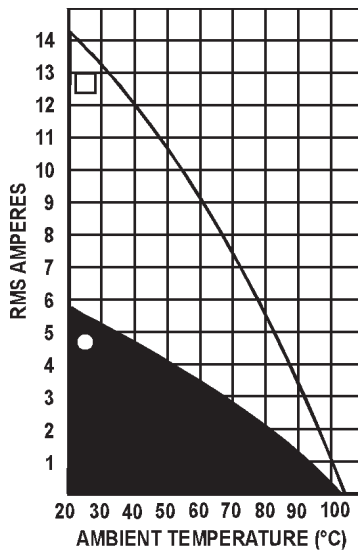

Surge Current Data

Time Second	Time*** (Cycles)	Peak Amps
0.017	1	110
0.050	3	85
0.100	6	70
0.200	12	60
0.500	30	50
1	60	40
2	120	33
3	180	32
4	240	31
5	300	30
10	600	28

Note: ***60 Hz



DATA SHEET

Form 859-990514

Specifications

AC Power - Printed Circuit Package (P & MP Series)

Model Number	Nominal AC Line Voltage	Nominal Current Rating Amps	1 cycle Surge (Amps) Peak	Nominal Signal Input Resistance (Ohms)	Signal Pick-up Voltage	Signal Drop-out Voltage	Peak Repetitive Voltage Maximum	Maximum Output Voltage Drop	Off-State Leakage mA Maximum	Operating Voltage Range (Volts AC)	I ² t Rating t=8.3 (ms)	Isolation Voltage	θ _{jc} * °C/Watt	Dissipation Watts/Amp
MP120D2 or P120D2	120	2	20	1000	3VDC** (32V allowed)	1 VDC	600	1.6 volts	5 mA	12-140	2	4,000 V _{RMS}	20	1.2
MP120D4 or P120D4	120	4	85	1000	3VDC** (32V allowed)	1 VDC	600	1.6 volts	5 mA	12-140	30	4,000 V _{RMS}	6.5	1.2
MP240D2 or P240D2	240	2	20	1000	3VDC** (32V allowed)	1 VDC	600	1.6 volts	5 mA	24-280	2	4,000 V _{RMS}	20	1.2
MP240D4 or P240D4	240	4	85	1000	3VDC** (32V allowed)	1 VDC	600	1.6 volts	5 mA	24-280	30	4,000 V _{RMS}	6.5	1.2
MP380D4	380	4	85	1000	3VDC** (32V allowed)	1 VDC	800	1.6 volts	5 mA	24-420	30	4,000 V _{RMS}	6.5	1.2

Notes: θ_{jc}* = Thermal resistance junction to base. Maximum junction temperature is 110°C.
** = MP Series 24 volts maximum.

Surge Current Data

Time Second	Time* (Cycles)	2-Amp P or MP Peak Amps	4-Amp P or MP Peak Amps
0.017	1	20	85
0.050	3	18	66
0.100	6	15	53
0.200	12	11	45
0.500	30	9	37
1	60	8.5	31
2	120	8	28
3	180	7.5	27
4	240	7	26
5	300	6.5	25
10	600	6	24

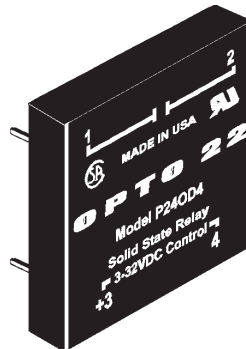

Model P240D4

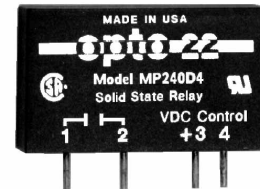

Model MP240D4

Note: *60 Hz

Dimensional Drawings

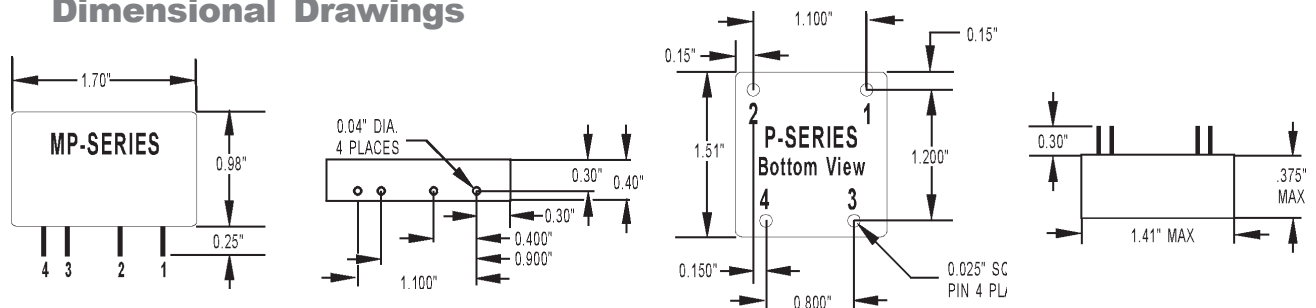

DATA SHEET

Form 859-990514

Description

DC Switching Series

MP Series

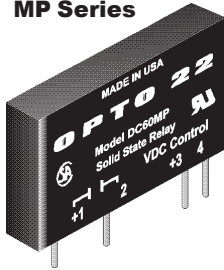

P Series

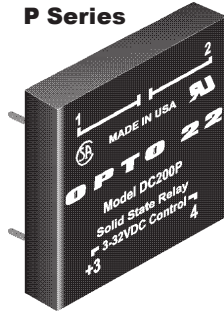

Power Series

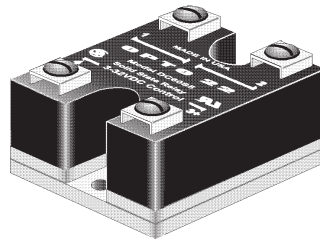

Thermal Ratings

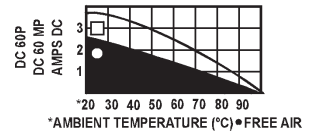
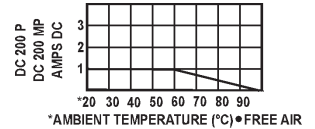

Specifications

	DC60P or DC60MP	DC200P or DC200MP	DC60S-3	DC60S-5
Operating Voltage Range	5-60 VDC	5-200 VDC	5-60 VDC	5-60 VDC
Forward Voltage Drop	1.5 volts at 3 amps	1.5 volts at 1 amp	1.5 volts at 3 amps	1.5 volts at 5 amps
Nominal Current Rating	3 amps	1 amp	3 amps	5 amps
Off-State Blocking	60 VDC	250 VDC	60 VDC	60 VDC
Signal Pickup Voltage	3 VDC 32 Volts* allowed	3 VDC 32 Volts* allowed	3 VDC 32 Volts allowed	3 VDC 32 Volts allowed
Signal Dropout Voltage	1 VDC	1 VDC	1 VDC	1 VDC
Signal Input Impedance	1,000 ohms	1,000 ohms	1,000 ohms	1,000 ohms
1 Second Surge	5 amps	2 amps	5 amps	10 amps
Operating Temp. Range	-40° C to 100° C	-40° C to 100° C	-40° C to 100° C	-40° C to 100° C
Isolation Voltage	4,000 VRMS	4,000 VRMS	4,000 VRMS	4,000 VRMS
Off-state Leakage	1 mA maximum	1 mA maximum	1 mA maximum	1 mA maximum
Package Type	P/M series	P/M series	Power series	Power series

Note: *MP series maximum allowed control signal 24 VDC.

Dimensional Drawings

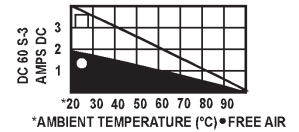
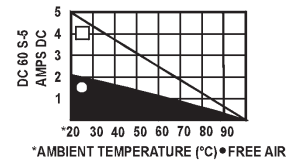
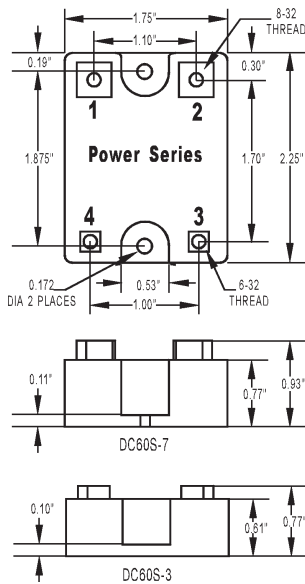

● FREE AIR
□ 2° C/WATT HEAT SINK (6" X 6" PLATE)

Dimensional Drawings

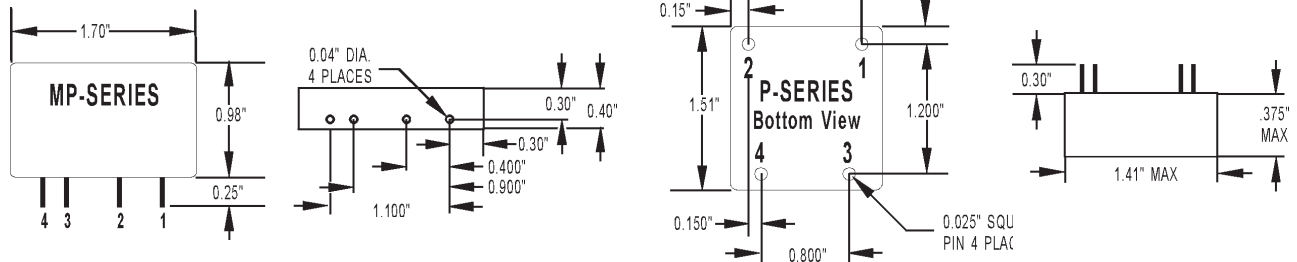

Form 859-990514

Applications

Tips

Heat Sink Calculation

Like all semiconductor devices, SSR current ratings must be based on maximum junction temperature. All Opto 22 SSRs operate conservatively at maximum junction temperatures of 110° C. Determining an adequate heat sink for a given SSR conducting a given current is very simple.

Note: Thermally conductive grease must be used between the relay base and the heat sink.

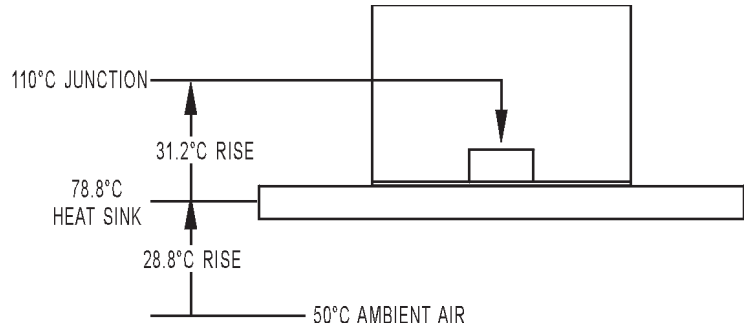

Sample Calculation Given:

120-Volt, 20-Amp Load
50° C Ambient Air

Choose Model 120D25 SSR.

Calculate dissipation as: **20 amps x 1.3 Watts per amp = 26 Watts**

Calculate temperature rise junction to SSR base as: **26 Watts x 1.2° C per Watt = 31.2° C**

Calculate allowable temperature of heat sink by subtracting 31.2° C from 110° C allowable junction temperature:

$$110^{\circ} \text{C} - 31.2 = 78.8^{\circ} \text{C}$$

The heat sink is in a 50° C ambient, therefore, allowable temperature rise on heat sink is: **78.8° C - 50° C = 28.8° C**

If heat sink is allowed to rise 28.8° C above ambient, then the thermal resistance of the heat sink is simply the 28.8° C rise divided by the 26 Watt. Any heat sink having a thermal resistance less than 1.1° C per Watt will be adequate.

Duty Cycle Calculation

When solid-state relays are operated in an on/off mode, it may be advantageous to calculate the RMS value of the current through the SSR for heat sinking or determining the proper current rating of the SSR for the given application.

I_{RMS} = RMS value of load or SSR

T_1 = Time current is on

T_2 = Time current is off

I_{ON} = RMS value of load current during on period

$$I_{\text{RMS}} = \sqrt{\frac{(I_{\text{ON}})^2 \times T_1}{T_1 + T_2}}$$

DATA SHEET

Form 859-990514

Applications

Tips (Continued)

Transformer Loads

Careful consideration should be given to the selection of the proper SSR for driving a given transformer. Transformers are driven from positive saturation of the iron core to negative saturation of the core each ½ cycle of the alternating voltage. Large inrush currents can occur during the first ½ cycle of line voltage when a zero voltage SSR happens to turn on during the positive ½ cycle of voltage when the core is already in positive saturation. Inrush currents greater than 10 times rated transformer current can easily occur. The following table provides a guide for selecting the proper SSR for a given transformer rating.

120-Volt Transformers	
SSR MODEL	TRANSFORMER
P or MP 120D2	100 VA
Z120D10	500 VA
120D3	100 VA
P or MP 120D4	250 VA
120D10 or 120A10	500 VA
120D25 or 120a25	1 KVA
120D45	2 KVA
240-Volt Transformers	
P or MP240D2	200 VA
7240D10	1 KVA
120D3	200 VA
P or MP240D4	500 VA
240D10 or 240A10	1 KVA
240D25 or 240A25	2 KVA
240D45	4 KVA
480-Volt Transformers	
SSR MODEL	TRANSFORMER
480D10-12	5-Amp Primary
480D15-12	5-Amp Primary

Solenoid Valve and Contactor Loads

All Opto 22 SSRs are designed to drive inductive loads such as solenoid valves and electromechanical contactors. The built-in snubber in each SSR assures proper operation into inductive loads. The following table is a guide in selecting an SSR to drive a solenoid or contactor.

120-Volt Coils		
SSR CURRENT RATING	SOLENOID	CONTACTOR
2-Amp	1-Amp	NEMA Size 4
4-Amp	3-Amp	NEMA Size 7
240-Volt Coils		
SSR CURRENT RATING	SOLENOID	CONTACTOR
2-Amp	1-Amp	NEMA Size 7
4-Amp	3-Amp	NEMA Size 7

Control Current Calculation

All Opto 22 DC controlled SSRs have a control circuit consisting of 1000 ohms in series with an LED. Since 3 volts is required to turn on any SSR, the maximum current required is (3 volt - 1 volt) divided by 1000 ohms which equals 2.0 mA. The 1 volt is subtracted from the 3 volt signal because 1 volt is dropped across the LED. For higher control voltages, an external resistor can be added in series with the control voltage to limit the control current. To limit the control current to 2 mA, calculate the external resistor $R_c = 500(E_c - 3)$ where E_c = the control voltage.

The DC control voltage range is 3–32 VDC. To calculate the control current for any voltage within the 3–32 VDC range, use the formula:

$$I_c = \frac{E_c - 1}{1000}$$

where $R_c = \text{zero}$.

With a 5V control signal,

$$I_c = \frac{5 - 1}{1000} = 4 \text{ mA.}$$

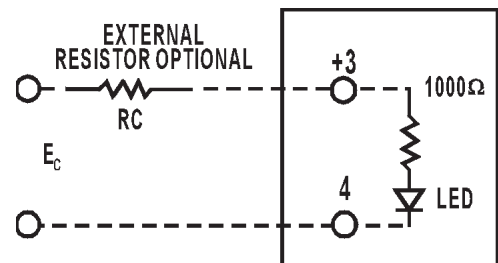

Form 859-990514

Applications

Tips (Continued)

Solid-State Relays In Series

In applications requiring greater current rating at higher voltage, two Opto 22 SSRs may be operated in series for double the voltage rating. The built-in snubber in each SSR assures proper voltage sharing of the two SSRs in series. In the diagram below, two 240-volt, 45-amp SSRs are connected in series for operation on a 480-volt line. The control is shown with a parallel hook-up but it should be noted that a serial connection can also be implemented.

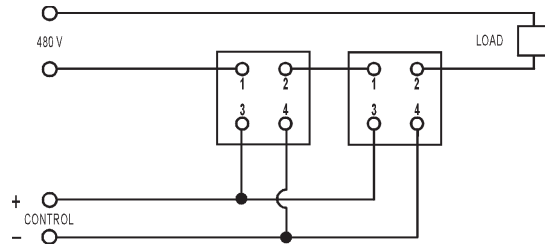

Lamp Loads

Since all Opto 22 SSRs are zero voltage switching, they are ideal for driving incandescent lamps because the initial inrush current into a cold filament is reduced. The life of the lamp is increased when switched by a zero voltage turn on SSR. The following table is a guide to selecting an Opto 22 SSR for switching a given incandescent lamp.

120 Volt Lamps	
SSR CURRENT RATING	LAMP RATING
2-Amp	100 Watt
4-Amp	400 Watt
10-Amp	1 Kilowatt
25-Amp	2 Kilowatt
45-Amp	3 Kilowatt
240 Volt Rating	
SSR CURRENT RATING	LAMP RATING
2-Amp	200 Watt
4-Amp	800 Watt
10-Amp	2 Kilowatt
25-Amp	4 Kilowatt
45-Amp	6 Kilowatt

Heater Loads

Care should be taken in selecting a SSR for driving a heater load if the load is cycled on and off in a continuous manner as might occur in a temperature control application. Constant cycling can cause thermal fatigue in the thyristor chip at the point where the chip bonds to the lead frame. Opto 22 employs a thick copper lead frame for mounting the SCR chips in the power series SSRs to eliminate thermal fatigue failures. In addition, Opto 22 recommends operating any SSR at 75% rated current for cycling heater loads to ensure complete reliability.

The following table is a guide to selecting the proper SSR for a given heater load.

Nominal SSR Current Rating	Maximum Recommended Heater Current
2-Amp	1½-Amp
4-Amp	2½-Amp
10-Amp	7½-Amp
25-Amp	18-Amp
45-Amp	35-Amp
10 480V	8-Amp
10 480V	8-Amp

Form 859-990514

Applications

Tips (Continued)

Single-Phase Reversing Motor Control

The circuit diagram illustrates a typical 1 Ø motor winding inductance and the phase shift capacitor can cause twice line voltage to appear across the open SSR. A 240-volt SSR should be used for a 120-Volt line. During the transition period when one SSR is turned on and the other SSR is going off, both SSRs may be on. In this case, the capacitor may discharge through the two SSRs, causing large currents to flow, which may destroy the SSRs. The addition of RL as shown will protect the SSRs from the short circuit capacitor discharge current.

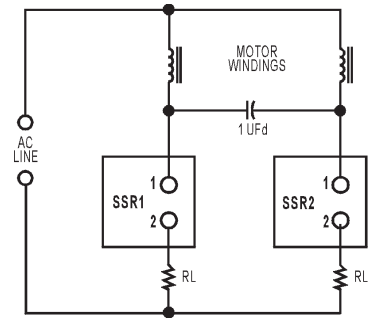

The resistors are unnecessary if the control circuit is designed to ensure one SSR is off before the other SSR is on.

CALCULATE RL as: $RL = \frac{1.4 EAC}{10 \times \text{SSR full load rating}}$

EXAMPLE: 10 amp SSR
120 V AC Line

$RL = \frac{1.4 \times 120}{10 \times 10} = 1.7 \text{ ohm}$

Three-Phase Motor Control

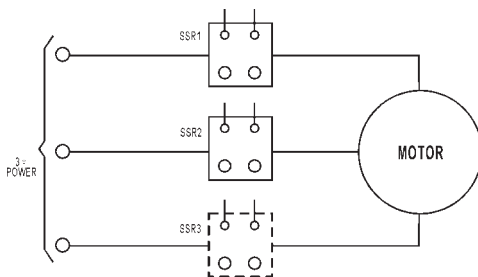

Three-phase motors may be controlled by solid-state relays as shown. A third SSR as shown is optional, but not necessary. The control windings may be connected in series or parallel. Care should be taken to ensure that surge current drawn by the motor does not exceed surge current rating of the SSR.

240-Volt 3Ø Motors	
SSR MODEL	MOTOR
Z240D25	1/3 HP
Z240D10	3/4 HP
240D10	3/4 HP
240A10	3/4 HP
240D25	2 HP
240A25	2 HP
240D45	3 HP
480-Volt 3Ø Motors	
SSR MODEL	MOTOR
480D10-12	1-½ HP
480D15-12	1-½ HP

Three-Phase Reversing Motor Control

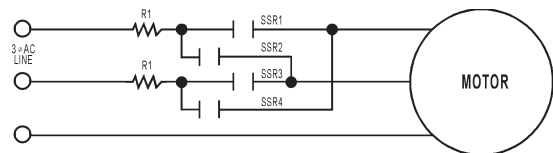

Three-phase reversing motor control can be implemented with four SSRs as shown in the connection diagram. The SSRs work in pairs with SSR1 and SSR3 operated for rotation in one direction and SSR2 and SSR4 operated for rotation in the reverse direction. The resistor R1 as shown in the connection diagram protects against line-to-line shorts if SSR1 and SSR4 or SSR3 and SSR2 are on at the same time during the reversing transition period. Use the following table as a guide to the proper selection of an SSR for this application.

Opto 22 Relay	Motor Full Load Rating	Resistor for 120V line	Resistor for 240V line
3-Amp	1.25-Amp	4 ohm 50 W	8 ohm 50 W
10-Amp	5-Amp	1 ohm 100 W	2 ohm 100 W
25-Amp	8-Amp	.5 ohm 100 W	1 ohm 100 W
45-Amp	16-Amp	.25 ohm 150 W	.5 ohm 150 W
15-Amp	5-Amp	1 ohm 100 W	2 ohm 100 W