

TOSHIBA POWER MOS FET MODULE SILICON N CHANNEL MOS TYPE (L²-π-MOSIII 4 IN 1)

MP4401

HIGH POWER, HIGH SPEED SWITCHING APPLICATIONS.

HAMMER DRIVE, PULSE MOTOR DRIVE AND INDUCTIVE LOAD SWITCHING.

INDUSTRIAL APPLICATIONS

Unit in mm

- 4-Volt Gate Drive Available
- Small Package by Full Molding (SIP 12 Pin)
- High Drain Power Dissipation (4 Devices Operation)
: P_T = 28W (T_c = 25°C)
- Low Drain-Source ON Resistance : R_{DS(ON)} = 0.33Ω (Typ.)
- Low Leakage Current : I_{GSS} = ±10μA (Max.) (V_{GS} = ±16V)
I_{DSS} = 100μA (Max.) (V_{DS} = 120V)
- Enhancement-Mode : V_{th} = 0.8~2.0V (I_D = 1mA)

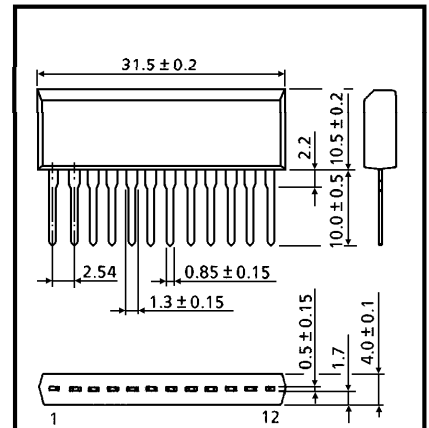

MOS FET	DIODE
1, 5, 8, 12 GATE	2, 4, 9, 11 ANODE
2, 4, 9, 11 DRAIN	3, 10 CATHODE
6, 7 SOURCE	

JEDEC	—
EIAJ	—
TOSHIBA	2-32C1D

Weight : 3.9g

MAXIMUM RATINGS (Ta = 25°C)

CHARACTERISTIC	SYMBOL	RATING	UNIT
Drain-Source Voltage	V _{DSS}	120	V
Gate-Source Voltage	V _{GSS}	±20	V
Drain Current	I _D	3	A
Peak Drain Current	I _{DP}	12	A
Drain Power Dissipation (1 Device Operation)	P _D	2.2	W
Drain Power Dissipation (4 Devices Operation)	T _a = 25°C	4.4	W
	T _c = 25°C	28	
Channel Temperature	T _{ch}	150	°C
Storage Temperature Range	T _{stg}	-55~150	°C

ARRAY CONFIGURATION

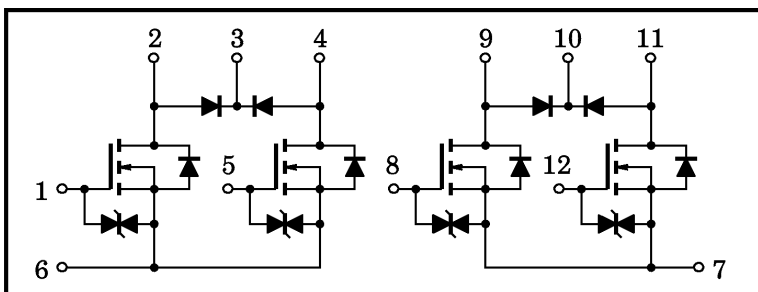

THERMAL CHARACTERISTICS

CHARACTERISTIC	SYMBOL	MAX.	UNIT
Thermal Resistance of Channel to Ambient (4 Devices Operation, Ta=25°C)	$\Sigma R_{th(ch-a)}$	28.4	°C / W
Thermal Resistance of Channel to Case (4 Devices Operation, Tc=25°C)	$\Sigma R_{th(ch-c)}$	4.46	°C / W
Maximum Lead Temperature for Soldering Purposes (3.2mm from Case for 10s)	T _L	260	°C

This Transistor is an Electrostatic Sensitive Device. Please Handle with Caution.

ELECTRICAL CHARACTERISTICS (Ta = 25°C)

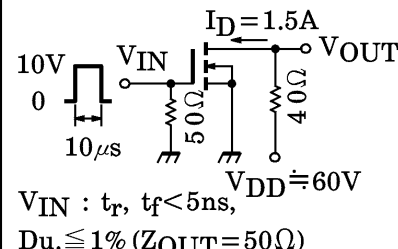
CHARACTERISTIC	SYMBOL	TEST CONDITION	MIN.	TYP.	MAX.	UNIT	
Gate Leakage Current	I _{GSS}	V _{GS} = ±16V, V _{DS} = 0	—	—	±10	μA	
Drain Cut-off Current	I _{DSS}	V _{DS} = 120V, V _{GS} = 0	—	—	100	μA	
Drain-Source Breakdown Voltage	V (BR) DSS	I _D = 10mA, V _{GS} = 0	120	—	—	V	
Gate Threshold Voltage	V _{th}	V _{DS} = 10V, I _D = 1mA	0.8	—	2.0	V	
Forward Transfer Admittance	Y _{fs}	V _{DS} = 10V, I _D = 1.5A	1.5	3.2	—	S	
Drain-Source ON Resistance	R _{D(S) ON}	I _D = 1.5A, V _{GS} = 4V	—	0.42	0.74	Ω	
	R _{D(S) ON}	I _D = 1.5A, V _{GS} = 10V	—	0.33	0.45		
Input Capacitance	C _{iss}	V _{DS} = 10V, V _{GS} = 0, f = 1MHz	—	350	—	pF	
Reverse Transfer Capacitance	C _{rss}	V _{DS} = 10V, V _{GS} = 0, f = 1MHz	—	35	—	pF	
Output Capacitance	C _{oss}	V _{DS} = 10V, V _{GS} = 0, f = 1MHz	—	155	—	pF	
Switching Time	Rise Time	t _r		—	6	—	ns
	Turn-on Time	t _{on}		—	12	—	
	Fall Time	t _f		—	40	—	
	Turn-off Time	t _{off}		—	100	—	
Total Gate Charge (Gate-Source Plus Gate-Drain)	Q _g	I _D = 3A, V _{GS} = 10V, V _{DD} = 96V	—	11	—	nC	
Gate-Source Charge	Q _{gs}		—	7	—		
Gate-Drain ("Miller") Charge	Q _{gd}		—	4	—		

SOURCE-DRAIN DIODE RATINGS AND CHARACTERISTICS (Ta = 25°C)

CHARACTERISTIC	SYMBOL	TEST CONDITION	MIN.	TYP.	MAX.	UNIT
Drain Reverse Current	I_{DR}	—	—	—	3	A
Peak Drain Reverse Current	I_{DRP}	—	—	—	12	A
Diode Forward Voltage	V_{DSF}	$I_{DR}=3A, V_{GS}=0$	—	-0.9	-1.5	V
Reverse Recovery Time	t_{rr}	$I_{DR}=3A, V_{GS}=0,$ $dI_{DR}/dt = -20A/\mu s$	—	130	—	ns
Reverse Recovery Charge	Q_{rr}		—	0.14	—	μC

FLYBACK-DIODE RATINGS AND CHARACTERISTICS (Ta = 25°C)

CHARACTERISTIC	SYMBOL	TEST CONDITION	MIN.	TYP.	MAX.	UNIT
Maximum Forward Current	I_{FM}	—	—	—	3	A
Reverse Current	I_R	$V_R=120V$	—	—	0.4	μA
Reverse Voltage	V_R	$I_R=100\mu A$	120	—	—	V
Forward Voltage	V_F	$I_F=0.5A$	—	—	1.8	V

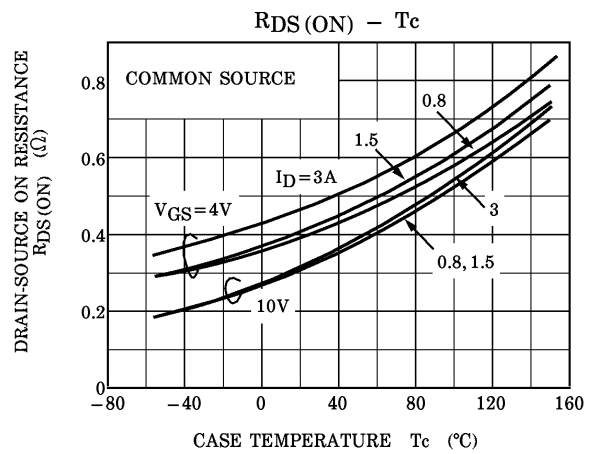
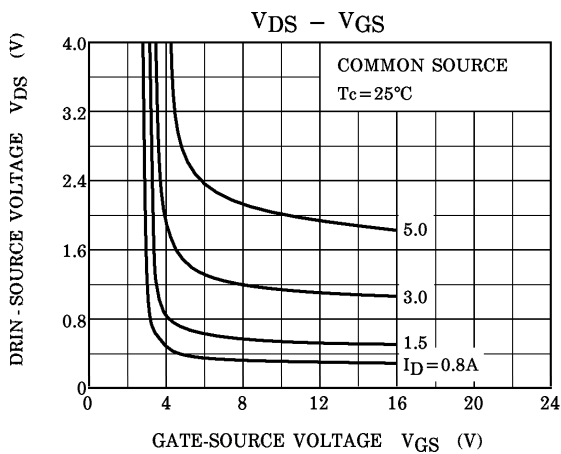
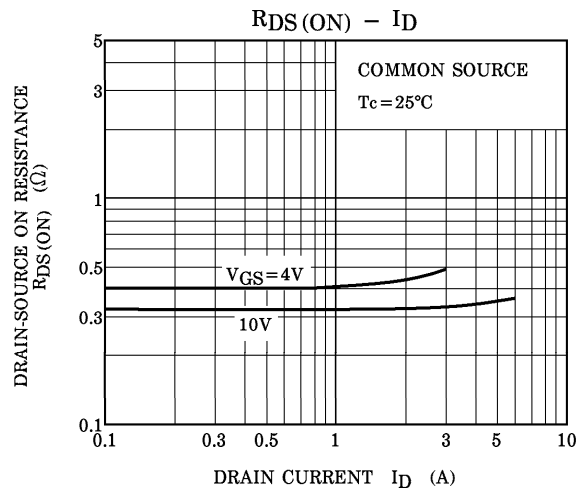
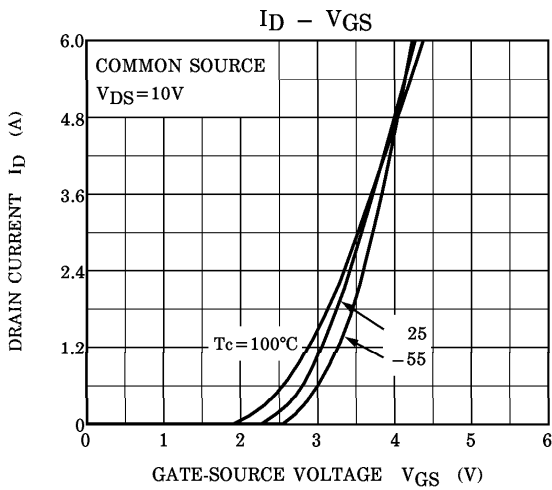
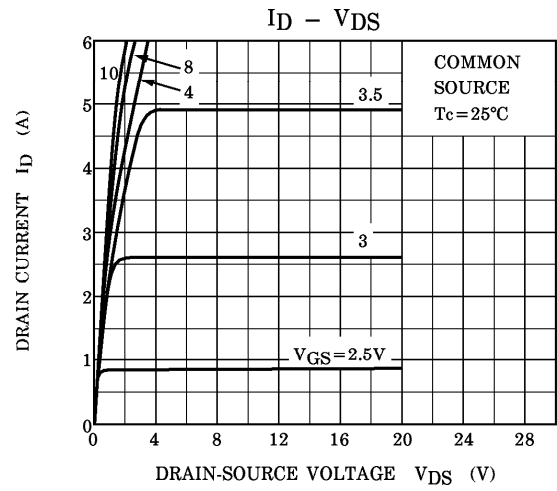
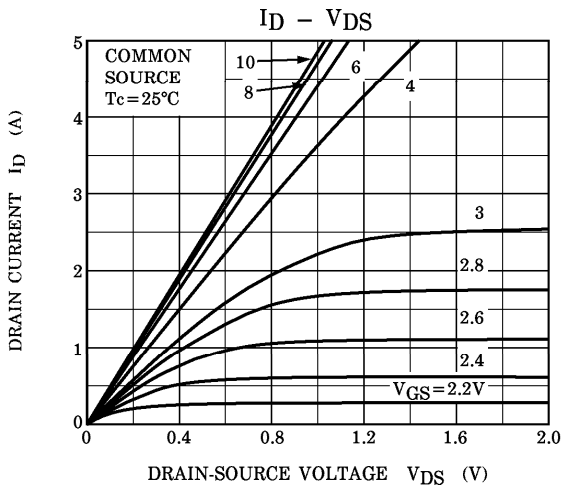

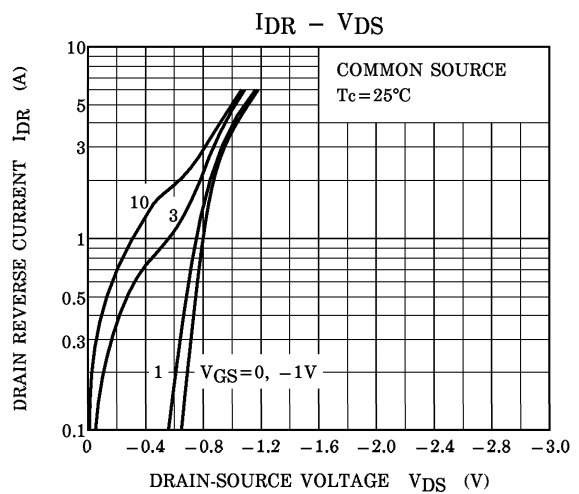
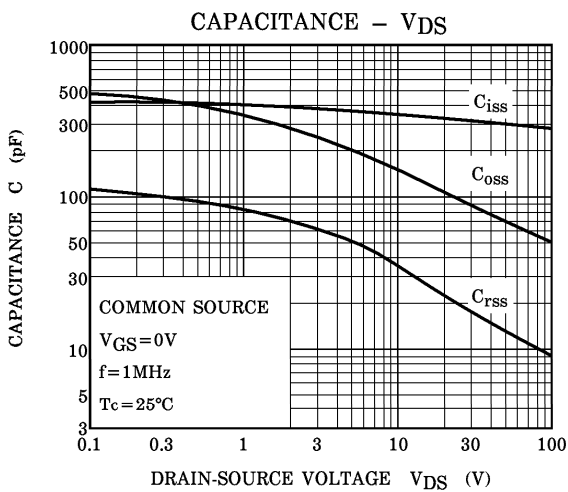
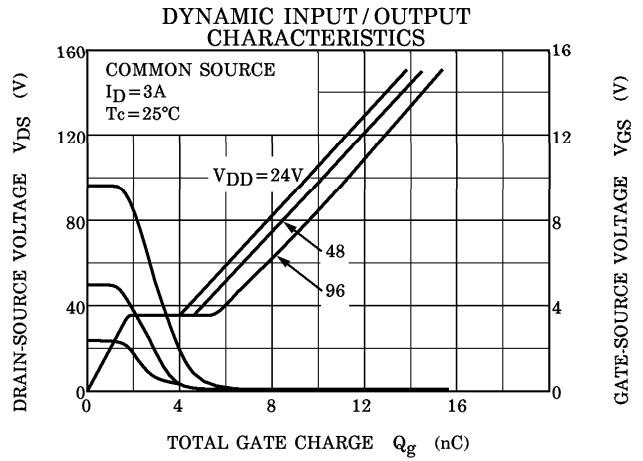
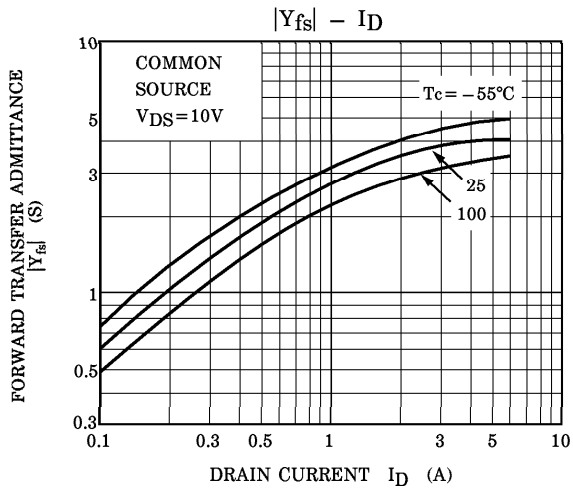
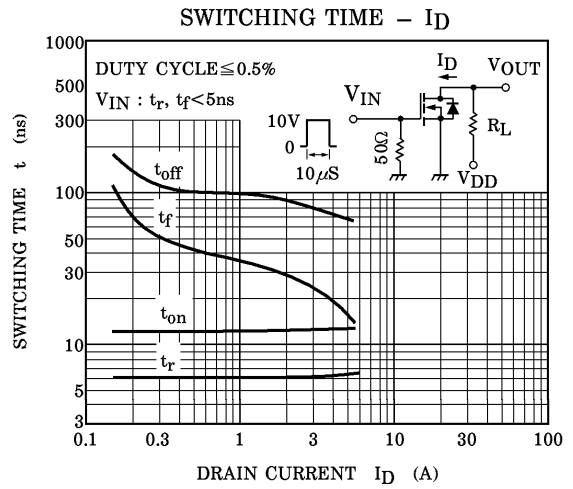
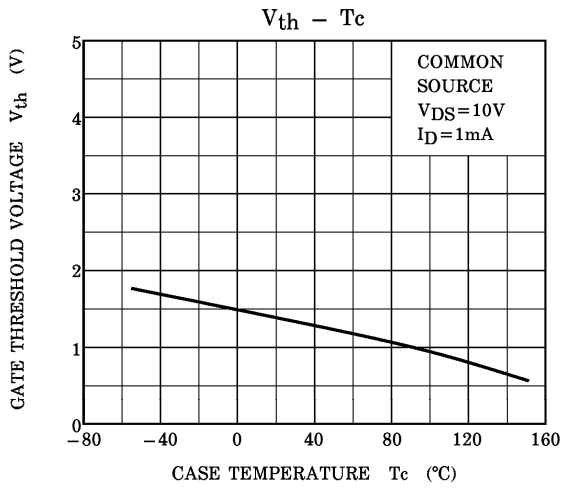

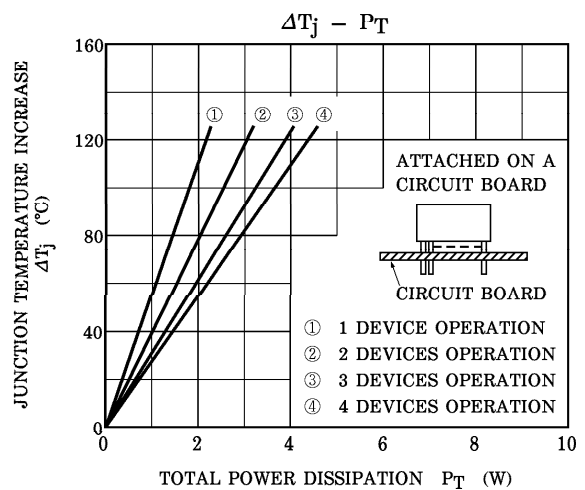
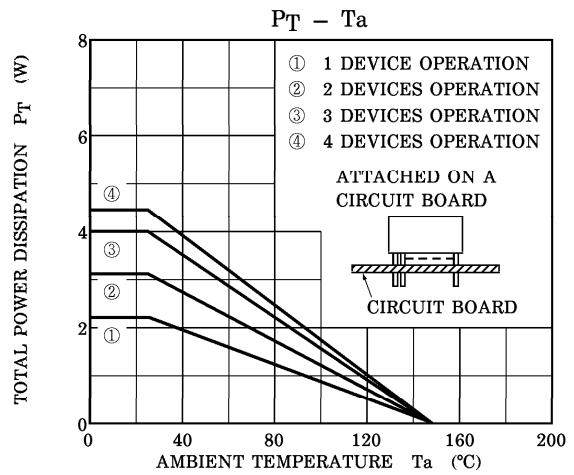
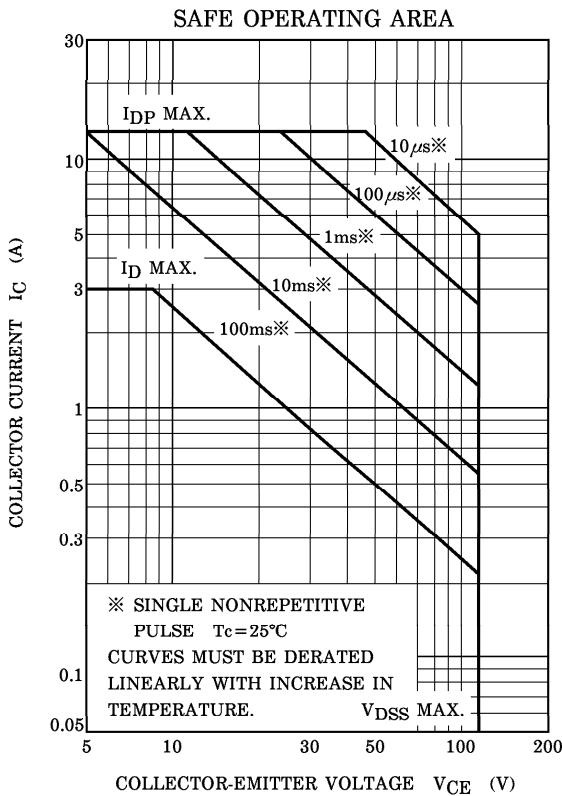
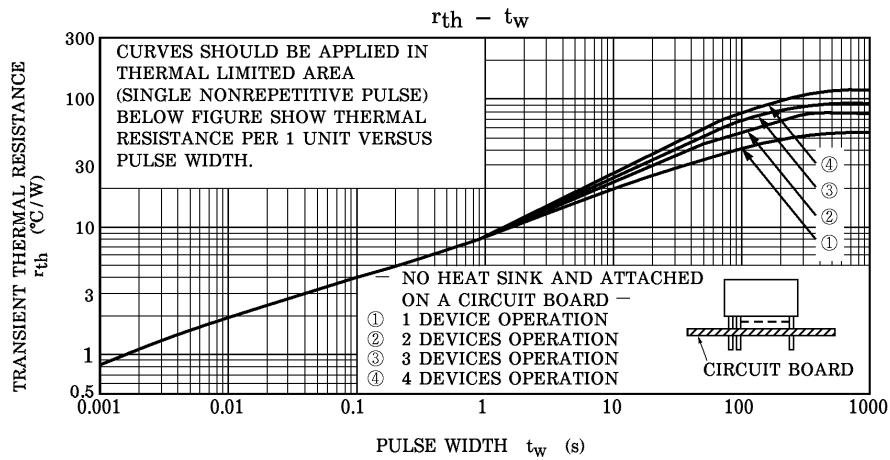

RESTRICTIONS ON PRODUCT USE

000707EAA

- TOSHIBA is continually working to improve the quality and reliability of its products. Nevertheless, semiconductor devices in general can malfunction or fail due to their inherent electrical sensitivity and vulnerability to physical stress. It is the responsibility of the buyer, when utilizing TOSHIBA products, to comply with the standards of safety in making a safe design for the entire system, and to avoid situations in which a malfunction or failure of such TOSHIBA products could cause loss of human life, bodily injury or damage to property. In developing your designs, please ensure that TOSHIBA products are used within specified operating ranges as set forth in the most recent TOSHIBA products specifications. Also, please keep in mind the precautions and conditions set forth in the "Handling Guide for Semiconductor Devices," or "TOSHIBA Semiconductor Reliability Handbook" etc..
- The TOSHIBA products listed in this document are intended for usage in general electronics applications (computer, personal equipment, office equipment, measuring equipment, industrial robotics, domestic appliances, etc.). These TOSHIBA products are neither intended nor warranted for usage in equipment that requires extraordinarily high quality and/or reliability or a malfunction or failure of which may cause loss of human life or bodily injury ("Unintended Usage"). Unintended Usage include atomic energy control instruments, airplane or spaceship instruments, transportation instruments, traffic signal instruments, combustion control instruments, medical instruments, all types of safety devices, etc.. Unintended Usage of TOSHIBA products listed in this document shall be made at the customer's own risk.
- The information contained herein is presented only as a guide for the applications of our products. No responsibility is assumed by TOSHIBA CORPORATION for any infringements of intellectual property or other rights of the third parties which may result from its use. No license is granted by implication or otherwise under any intellectual property or other rights of TOSHIBA CORPORATION or others.
- The information contained herein is subject to change without notice.