

M-Pulse Microwave

Silicon Bipolar MMIC Cascadable Amplifier

MP4TD0310

Features

- Cascadable 50Ω Gain Block
- 3dB Bandwidth: DC to 2.0 GHz
- 12.1 dB Typical Gain @ 1.0 GHz
- Unconditionally Stable ($k > 1$)
- Hermetic Gold-Ceramic Microstrip Package
- Tape and Reel Packaging Available

Description

M-Pulse's MP4TD0310 is a high performance silicon bipolar MMIC housed in a hermetic high reliability package. The MP4TD0310 is designed for use where a general purpose 50Ω gain block is required. Typical applications include narrow and wide band IF and RF amplifiers in industrial and military applications.

The MP4TD0310 is fabricated using a 10 GHz f_T silicon bipolar technology that features gold metalization and IC passivation for increased performance and reliability.

TYPICAL POWER GAIN vs FREQUENCY

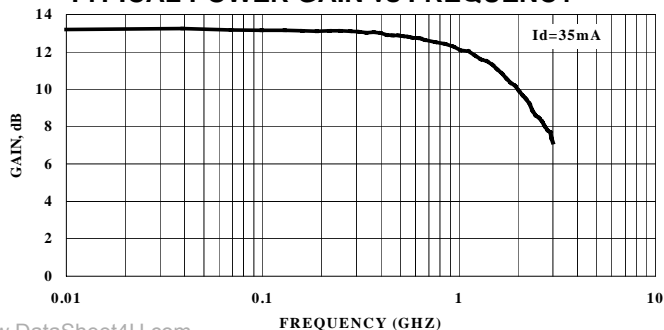

www.DataSheet4U.com

Gold-Ceramic Microstrip Package Outline^{1,2}

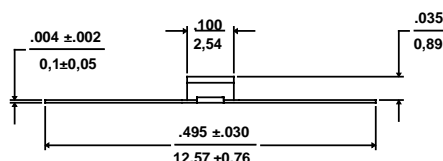
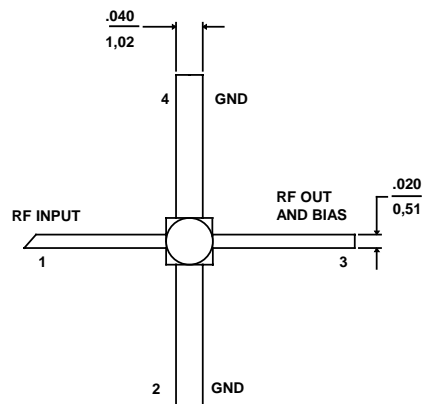

Notes: (unless otherwise specified)

1. Dimensions are in / mm
2. Tolerance: in .xxx = ±.005; mm .xx = ±.13

Pin Configuration

Pin Number	Pin Description
1	RF Input
2 & 4	AC/DC Ground
3	RF Output and DC Bias

Ordering Information

Model No.	Package
MP4TD0310	Hermetic Ceramic

Electrical Specifications @ $T_A = +25^\circ\text{C}$, $I_d = 35 \text{ mA}$, $Z_0 = 50\Omega$

Symbol	Parameters	Test Conditions	Units	Min.	Typ.	Max.
G_p	Power Gain ($ S_{21} ^2$)	$f = 0.1 \text{ GHz}$	dB	11.5	13.0	14.0
ΔG_p	Gain Flatness	$f = 0.1 \text{ to } 1.5 \text{ GHz}$	dB	-	± 0.8	± 1.1
f_{3dB}	3 dB Bandwidth	-	GHz	-	2.0	-
SWR_{in}	Input SWR	$f = 0.1 \text{ to } 3.0 \text{ GHz}$	-	-	1.9	-
SWR_{out}	Output SWR	$f = 0.1 \text{ to } 3.0 \text{ GHz}$	-	-	1.6	-
P_{1dB}	Output Power @ 1dB Gain Compression	$f = 1.0 \text{ GHz}$	dBm	-	10.0	-
NF	50 Ω Noise Figure	$f = 1.0 \text{ GHz}$	dB	-	5.7	-
IP_3	Third Order Intercept Point	$f = 1.0 \text{ GHz}$	dBm	-	23.0	-
t_d	Group Delay	$f = 1.0 \text{ GHz}$	ps	-	125	-
V_d	Device Voltage	-	V	4.5	5.0	6.0
dV/dT	Device Voltage Temperature Coefficient	-	mV/°C	-	-8.0	-

Specification Subject to Change Without Notice

M-Pulse Microwave

North America: Tel. (408) 432-1480
Fax (408) 432-3440

Absolute Maximum Ratings¹

Parameter	Absolute Maximum
Device Current	80 mA
Power Dissipation ^{2,3}	425 mW
RF Input Power	+13 dBm
Junction Temperature	200°C
Storage Temperature	-65°C to +200°C

Thermal Resistance: $\theta_{jC} = 150^{\circ}\text{C/W}$

1. Exceeding these limits may cause permanent damage.
2. Case Temperature (T_c) = 25 °C.
3. Derate at 6.7 mW/°C for $T_c > 136^{\circ}\text{C}$.

Typical Bias Configuration

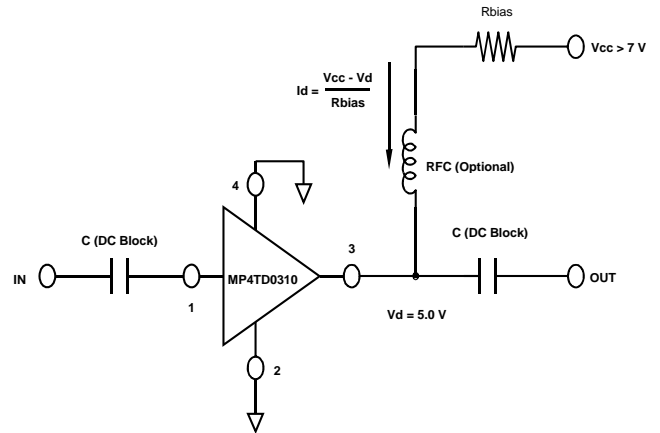

Typical Performance Curves @ $I_d = 35\text{ mA}$, $T_A = +25^{\circ}\text{C}$ (unless otherwise noted)

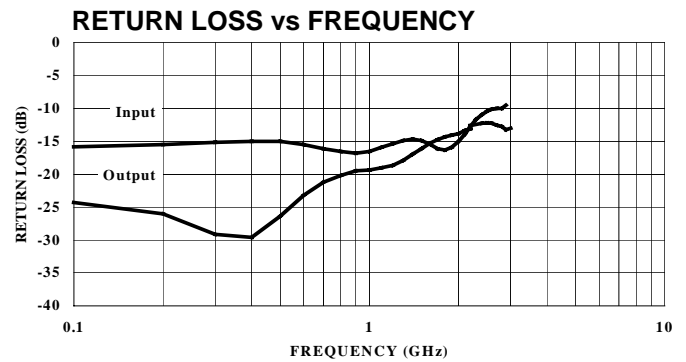
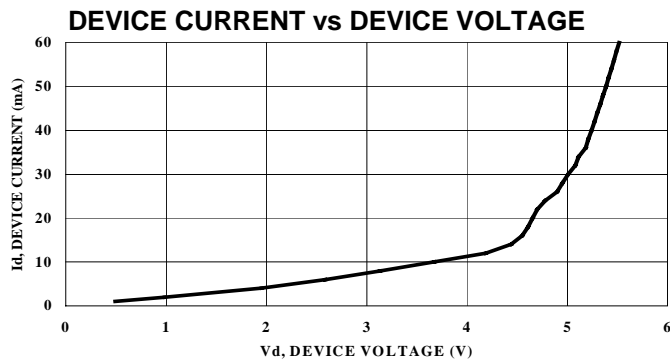

www.DataSheet4U.com

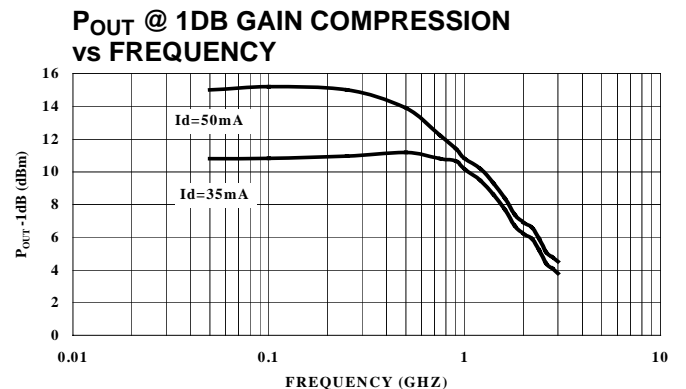
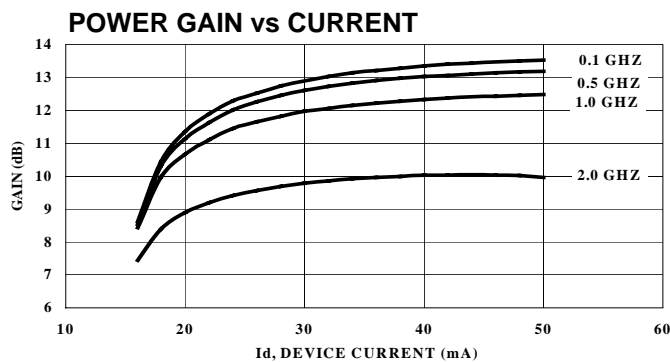

Specification Subject to Change Without Notice

M-Pulse Microwave

North America: Tel. (408) 432-1480
Fax (408) 432-3440

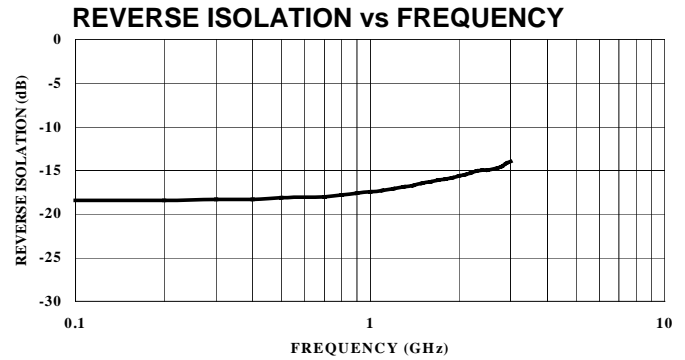
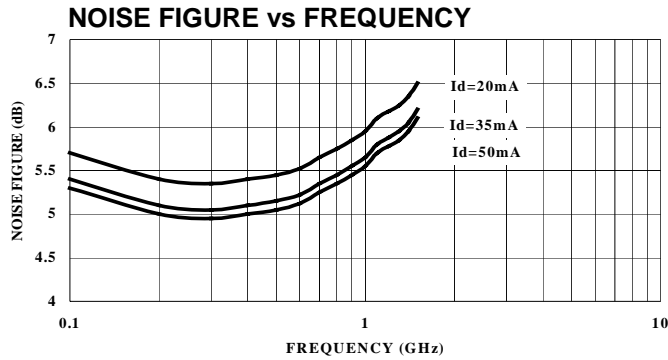

Typical Scattering Parameters

$Z_0 = 50\Omega$, $T_A = +25^\circ\text{C}$, $I_d = 35\text{ mA}$

Frequency (GHz)	S11		S21		S12		S22	
	Mag.	Angle	Mag.	Angle	Mag.	Angle	Mag	Angle
0.1	0.162	172.4	4.58	175.8	0.120	2.7	0.061	-0.1
0.2	0.168	167.1	4.56	171.5	0.120	5.2	0.050	-7.5
0.3	0.175	163.2	4.54	167.4	0.121	7.7	0.035	-26.7
0.4	0.178	159.1	4.51	163.2	0.121	9.9	0.033	-68.4
0.5	0.177	155.7	4.47	159.0	0.124	12.3	0.048	-101.2
0.6	0.168	151.4	4.43	154.9	0.125	14.2	0.069	-112.4
0.7	0.157	146.4	4.39	150.9	0.126	16.4	0.087	-118.0
0.8	0.149	139.8	4.35	147.2	0.129	18.2	0.098	-121.5
0.9	0.144	135.2	4.30	143.4	0.132	20.5	0.106	-124.9
1.0	0.149	132.6	4.25	139.4	0.134	22.2	0.108	-129.4
1.5	0.180	142.4	3.81	120.2	0.150	30.8	0.156	-168.8
2.0	0.177	149.3	3.43	104.5	0.166	35.1	0.204	174.7
2.5	0.302	163.5	2.80	89.0	0.179	36.9	0.245	176.4
3.0	0.334	168.8	2.70	79.6	0.201	38.8	0.223	179.4

Specification Subject to Change Without Notice