

M-Pulse Microwave

Silicon Bipolar MMIC Cascadable Amplifier

MP4TD1110

Features

- High Dynamic Range Cascadable 50Ω/75Ω Gain Block
- 3dB Bandwidth: 50 MHz to 1.3 GHz
- 17.0 dBm Typical P_{1dB} @ 1.0 GHz
- 12 dB Typical Gain @ 0.5 GHz
- 3.8 dB Typical Noise Figure @ 1.0 GHz
- Hermetic Gold-Ceramic Microstrip Package
- Tape and Reel Packaging Available

Description

M-Pulse's MP4TD1110 is a high performance silicon bipolar MMIC housed in a hermetic high reliability package. The MP4TD1110 is designed for use in systems where a high dynamic range and low distortion gain block is required. Typical applications include narrow and wide band IF and RF amplifiers in industrial and military applications.

The MP4TD1110 is fabricated using a 10 GHz f_T silicon bipolar technology that features gold metalization and IC passivation for increased performance and reliability.

Gold-Ceramic Microstrip Package Outline^{1,2}

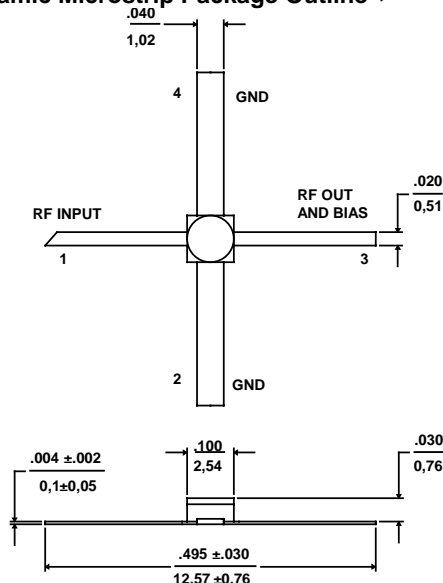

Notes: (unless otherwise specified)

1. Dimensions are in / mm
2. Tolerance: in .xxx = ±.005; mm .xx = ±.13

TYPICAL POWER GAIN vs FREQUENCY

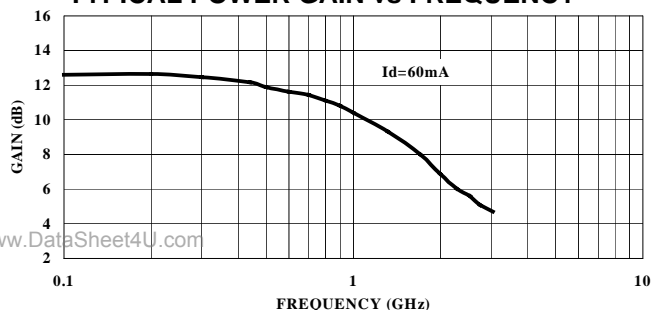

Pin Configuration

Pin Number	Pin Description
1	RF Input
2 & 4	AC/DC Ground
3	RF Output and DC Bias

Ordering Information

Model No.	Package
MA4TD1110	Hermetic Ceramic
MA4TD1110T	Tape and Reel

Electrical Specifications @ $T_A = +25^\circ\text{C}$, $I_d = 60 \text{ mA}$, $Z_0 = 50\Omega$

Symbol	Parameters	Test Conditions	Units	Min.	Typ.	Max.
Gp	Power Gain ($ S_{21} ^2$)	f = 0.1 GHz	dB	11.5	12.5	13.5
ΔG_p	Gain Flatness	f = 0.1 to 0.7 GHz	dB	-	±0.8	±1.0
f_{3dB}	3 dB Bandwidth	ref 50 MHz Gain	GHz	-	1.3	-
SWR _{in}	Input SWR	f = 0.1 to 2.0 GHz	-	-	1.9	-
SWR _{out}	Output SWR	f = 0.1 to 2.0 GHz	-	-	2.1	-
P_{1dB}	Output Power @ 1 dB Gain Compression	f = 0.7 GHz	dBm	16.0	17.0	-
NF	50 Ω Noise Figure	f = 0.7 GHz	dB	-	3.8	4.5
IP ₃	Third Order Intercept Point	f = 1.0 GHz	dBm	-	30.0	-
t_p	Group Delay	f = 1.0 GHz	ps	-	160	-
V _d	Device Voltage	-	V	4.5	5.5	6.5
dV/dT	Device Voltage Temperature Coefficient	-	mV/°C	-	-8.0	-

Specification Subject to Change Without Notice

Absolute Maximum Ratings¹

Parameter	Absolute Maximum
Device Current	90 mA
Power Dissipation ^{2,3}	560 mW
RF Input Power	+20 dBm
Junction Temperature	200°C
Storage Temperature	-65°C to +200°C
Thermal Resistance: $\theta_{jC} = 135^{\circ}\text{C/W}$	

1. Exceeding these limits may cause permanent damage.
2. Case Temperature (T_c) = 25 °C.
3. Derate at 7.4 mW/°C for $T_c > 124^{\circ}\text{C}$.

Typical Bias Configuration

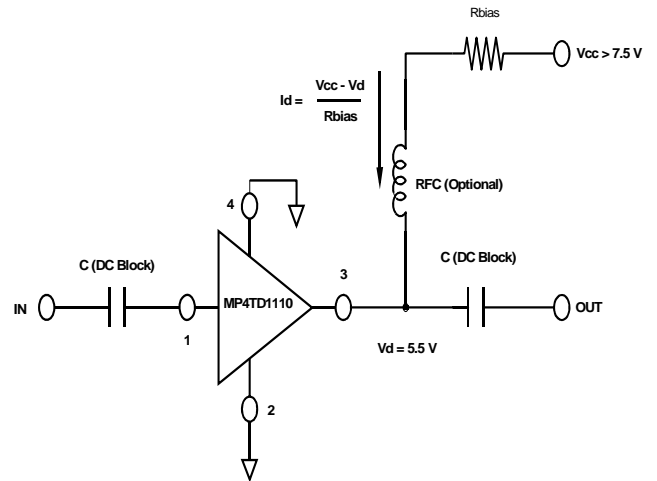

Typical Performance Curves @ $I_d = 60\text{ mA}$, $T_A = +25^{\circ}\text{C}$ (unless otherwise noted)

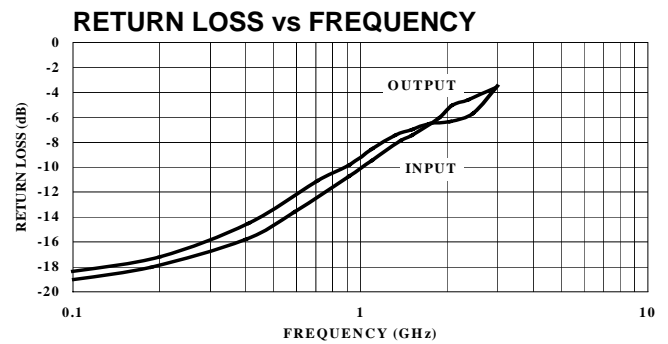
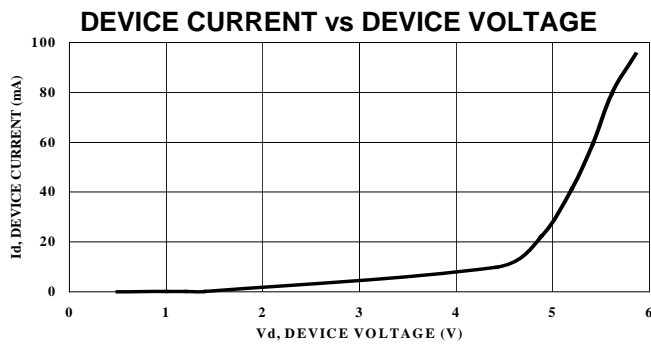

www.DataSheet4U.com

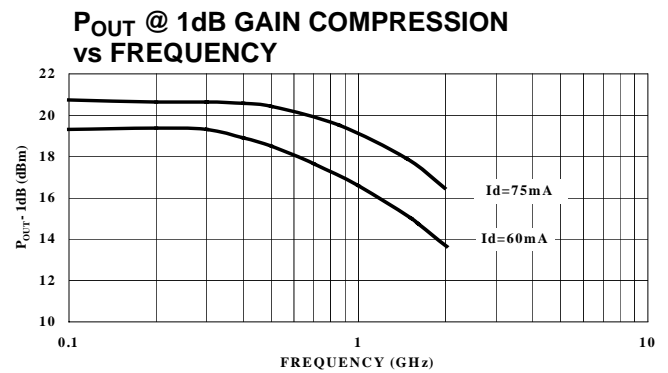
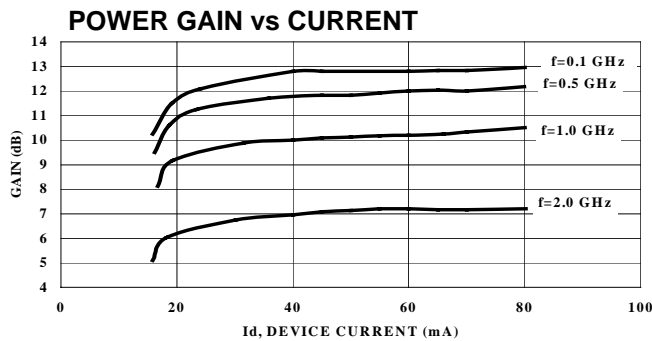

Specification Subject to Change Without Notice

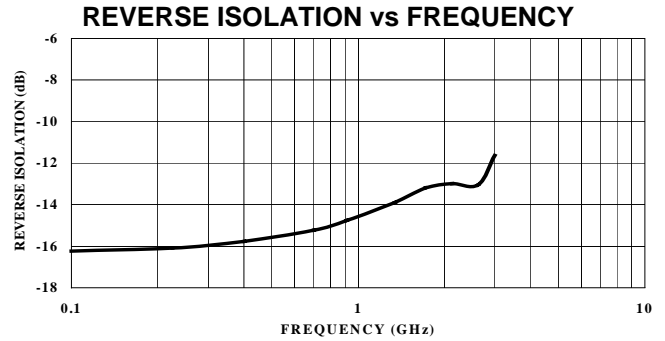
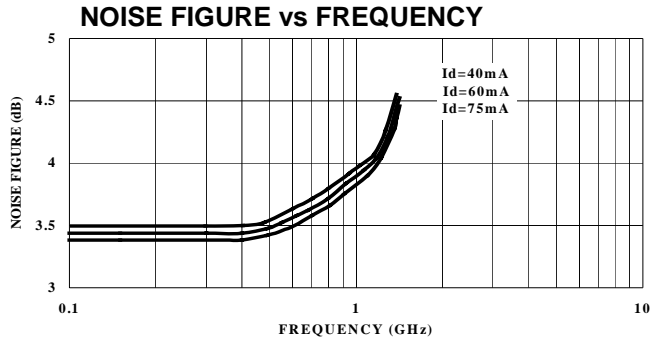

Typical Scattering Parameters
Z₀ = 50Ω, T_A = +25°C, I_d = 60 mA

Frequency (GHz)	S ₁₁		S ₂₁		S ₁₂		S ₂₂	
	Mag.	Angle	Mag.	Angle	Mag.	Angle	Mag	Angle
0.1	0.117	-129.1	4.26	162.7	0.156	6.4	0.12	-128.3
0.2	0.131	-131.3	4.20	159.2	0.157	7.1	0.14	-130.9
0.3	0.149	-134.2	4.12	154.8	0.160	8.0	0.17	-133.8
0.4	0.171	-137.7	4.02	149.5	0.162	9.0	0.20	-137.2
0.5	0.197	-142.1	3.90	143.5	0.166	10.2	0.23	-141.2
0.6	0.225	-146.3	3.77	137.4	0.170	11.4	0.26	-144.8
0.7	0.252	-150.7	3.63	131.6	0.174	12.4	0.29	-148.6
0.8	0.279	-155.1	3.49	126.0	0.177	13.3	0.31	-152.9
0.9	0.305	-159.4	3.36	120.7	0.181	14.0	0.33	-157.4
1.0	0.330	-163.3	3.22	115.6	0.185	14.7	0.36	-162.1
1.1	0.354	-167.1	3.09	110.7	0.189	15.0	0.38	-166.7
1.2	0.377	-170.5	2.97	106.1	0.192	15.2	0.40	-171.1
1.3	0.400	-173.8	2.85	101.7	0.196	15.1	0.42	-175.2
1.4	0.421	-177.2	2.74	97.7	0.199	15.0	0.44	-178.5
1.5	0.441	179.4	2.63	93.9	0.204	15.1	0.46	178.9
1.6	0.460	176.1	2.52	90.4	0.208	15.1	0.48	177.0
1.7	0.477	172.8	2.42	87.2	0.212	15.5	0.49	175.4
1.8	0.495	169.8	2.33	84.2	0.217	16.1	0.49	173.9
1.9	0.513	167.5	2.25	81.1	0.221	16.7	0.50	172.3
2.0	0.533	165.3	2.17	77.9	0.223	17.3	0.51	170.4
2.1	0.553	163.6	2.10	74.6	0.225	17.7	0.51	168.1
2.2	0.574	162.1	2.03	71.3	0.226	17.4	0.52	165.4
2.3	0.591	160.6	1.97	67.9	0.225	16.9	0.53	162.6
2.4	0.605	159.0	1.91	64.6	0.225	15.8	0.54	160.0
2.5	0.615	157.4	1.86	61.5	0.227	14.4	0.55	157.7
2.6	0.623	155.7	1.82	58.8	0.231	12.7	0.57	155.8
2.7	0.632	154.3	1.79	56.2	0.239	10.9	0.60	154.1
2.8	0.638	153.0	1.76	54.1	0.248	9.2	0.62	153.0
2.9	0.642	152.1	1.75	52.5	0.257	7.9	0.65	152.4
3.0	0.648	151.5	1.75	51.3	0.266	6.9	0.67	151.9

Specification Subject to Change Without Notice