

DESCRIPTION

The MP5036A is a protection device designed to protect circuitry on the output from transients on the input, while simultaneously protecting the input from undesired shorts and transients from the output.

The DV/DT pin controls the slew rate at the output. The slew rate limits the inrush current during start-up.

The maximum load at the output is current-limited. The magnitude of the current limit is controlled by an external resistor from ILIMIT to GND. There is a fixed, 2.5A current limit when floating the ILIMIT pin.

The output voltage is limited by the output's over-voltage protection (OVP) function.

The device is available in a TSOT23-6 package.

FEATURES

- Wide 2.9V to 5.5V Continuous Operating Input Range
- 26V Absolute Maximum Transient Input Voltage
- Fixed 5.75V Over-Voltage Clamp Threshold
- Fast Output OVP Response
- Integrated 43mΩ Power FET
- Adjustable Current Limit or Fixed Current Limit when Floating ILIMIT Pin
- Soft-Start Time Programmable through DV/DT Pin
- Fast Response for Hard Short Protection
- OCP Hiccup Protection
- Thermal Shutdown and Auto-Retry
- Available in a TSOT23-6 Package

APPLICATIONS

- HDD, SSD
- Hot-Swap
- Wireless Modem Data Cards
- PC Cards
- USB Power Distribution
- USB Protection
- USB3.1 Power Delivery

All MPS parts are lead-free, halogen free, and adhere to the RoHS directive. For MPS green status, please visit the MPS website under Quality Assurance. "MPS", the MPS logo, and "Simple, Easy Solutions" are registered trademarks of Monolithic Power Systems, Inc. or its subsidiaries.

TYPICAL APPLICATION

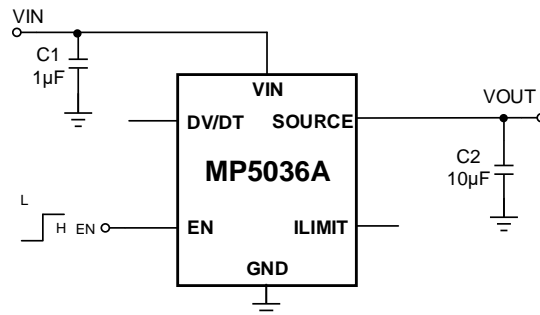

ORDERING INFORMATION

Part Number*	Package	Top Marking
MP5036AGJ	TSOT23-6	See Below

* For Tape & Reel, add suffix –Z (e.g. MP5036AGJ–Z).

TOP MARKING

| BGQY

BGQ: Product code of MP5036AGJ

Y: Year code

PACKAGE REFERENCE

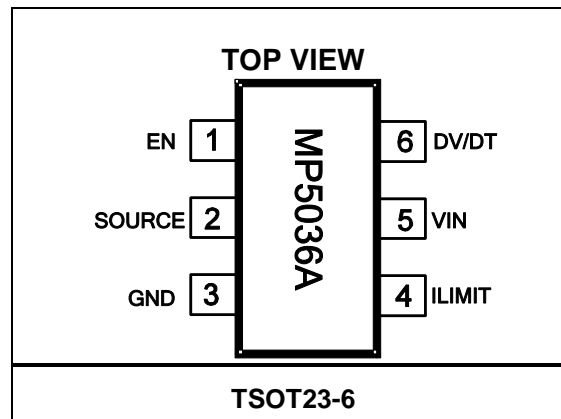

PIN FUNCTIONS

Pin #	Name	Description
1	EN	Enable. Forces EN high to enable the MP5036A. Float EN or pull EN to GND to disable the IC. For quick start-up, pull EN up to VIN through a 300kΩ resistor.
2	SOURCE	Source of the internal power MOSFET and output terminal of the IC.
3	GND	System ground.
4	ILIMIT	Current limit set. Place a resistor between ILIMIT and GND to set the value of the current limit. Float ILIMIT to achieve a 2.5A fixed current limit.
5	VIN	Supply voltage. The MP5036A operates from a 2.9V to 5.5V input rail. A ceramic capacitor is required to decouple the input rail. Connect VIN using a wide PCB trace.
6	DV/DT	DV/DT. Connect a capacitor from DV/DT to GND to set the DV/DT slew rate.

ABSOLUTE MAXIMUM RATINGS ⁽¹⁾

VIN, SOURCE	-0.3V to +26V
All other pins	-0.3V to +5.5V
Junction temperature	-40°C to +150°C
Lead temperature	260°C
Continuous power dissipation (TA = 25°C) ^{(2) (4)}	
TSOT23-6.....	1.89W

Recommended Operating Conditions ⁽³⁾

Continued operating VIN.....	2.9V to 5.5V
Operating junction temp (TJ)	-40°C to +125°C

Thermal Resistance θ_{JA} θ_{JC}
TSOT23-6

EV5036A-J-00A ⁽⁴⁾	66.....	23.....	°C/W
JESD51-7 ⁽⁵⁾	100.....	55.....	°C/W

Notes:

- 1) Exceeding these ratings may damage the device.
- 2) The maximum allowable power dissipation is a function of the maximum junction temperature T_J (MAX), the junction-to-ambient thermal resistance θ_{JA} , and the ambient temperature T_A . The maximum allowable continuous power dissipation on EV5036A-J-00A board at any ambient temperature is calculated by P_D (MAX) = $(T_J$ (MAX) - T_A) / θ_{JA} . Exceeding the maximum allowable power dissipation will cause excessive die temperature, and the MP5036A will go into thermal shutdown. Internal thermal shutdown circuitry protects the device from permanent damage.
- 3) The device is not guaranteed to function outside of its operating conditions.
- 4) Measured on EV5036A-J-00A, 2-layer PCB, 50mmx50mm.
- 5) Measured on JESD51-7, 4-layer PCB.

ELECTRICAL CHARACTERISTICS

$V_{IN} = 5V$, $R_{LIMIT} = NS$, $C_{OUT} = 10\mu F$, $T_J = -40^{\circ}C$ to $+125^{\circ}C$ ⁽⁶⁾, typical value is tested at $T_J = 25^{\circ}C$, unless otherwise noted.

Parameter	Symbol	Condition	Min	Typ	Max	Units
Supply Current						
Quiescent current	I_Q	EN = HIGH		50		μA
Shutdown current	I_S	EN = GND		9		μA
Power FET						
On resistance	$R_{DS(ON)}$	$I_{OUT} = 1A$		43		m Ω
Turn-on delay	t_{DELAY}			500		μs
Off-state leakage current	I_{OFF}	EN = 0V		0.1	1	μA
Under/Over-Voltage Protection						
Under-voltage lockout rising threshold	V_{UVLO}		2.55	2.7	2.85	V
UVLO hysteresis	$V_{UVLOHYS}$			200		mV
Output over-voltage clamp voltage	V_{CLAMP}		5.5	5.75	6	V
DV/DT						
DV/DT slew rate	dv/dt	DV/DT float	0.4	0.8	1.2	V/ms
DV/DT current	$I_{DV/DT}$	$V_{DV/DT} = 0.5V$	4.5	6.5	8.5	μA
Current Limit						
Current limit at normal operation	I_{LIMIT_NO}	Float ILIMIT pin, $T_J = 25^{\circ}C$	2.3	2.5	2.7	A
		$R_{LIMIT} = 620\Omega$, $T_J = 25^{\circ}C$	3.2	3.5	3.8	A
		$R_{LIMIT} = 3k\Omega$, $T_J = 25^{\circ}C$	0.68	0.75	0.82	A
Enable						
Enable rising threshold	V_{EN_RISING}		1.86	2	2.16	V
Enable hysteresis	V_{EN_HYS}			350		mV
Enable pull-down resistor	R_{EN_DOWN}			2.2		M Ω
Output Discharge						
Discharge resistance	R_{DIS}	$V_{IN} = 5V$		540		Ω
OTP						
Thermal shutdown ⁽⁷⁾	T_{SD}			175		$^{\circ}C$
Thermal hysteresis ⁽⁷⁾	T_{SD_HYS}			50		$^{\circ}C$

Notes:

- 6) Not tested in production. Guaranteed by over-temperature correlation.
 7) Guaranteed by engineering sample characterization.

TYPICAL PERFORMANCE CHARACTERISTICS

$V_{IN} = 5V$, $V_{EN} = 5V$, $R_{LIMIT} = 620\Omega$, $C_{OUT} = 10\mu F$, $T_A = 25^\circ C$, unless otherwise noted.

Current Limit vs. R_{LIMIT}

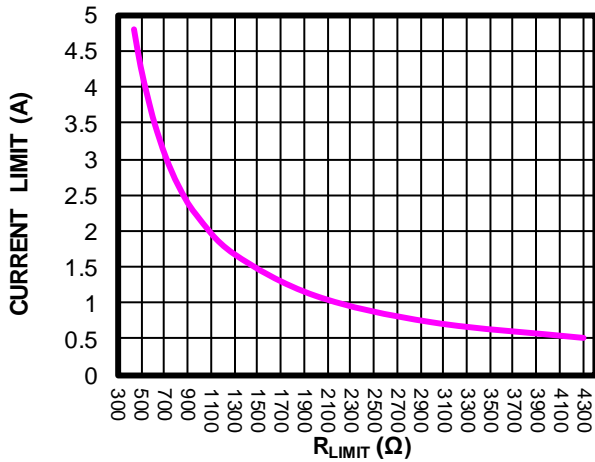

Current Limit vs. Input Voltage

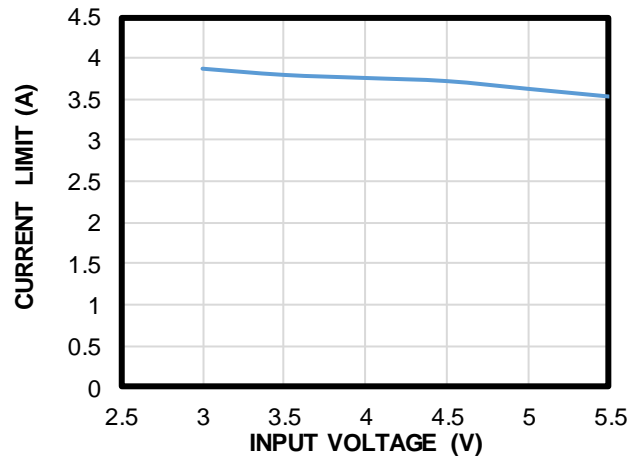

$R_{DS(ON)}$ vs. Load Current

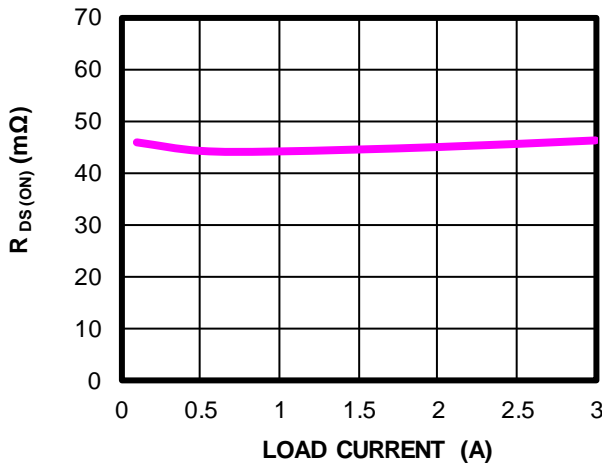

Quiescent Current vs. Input Voltage

$V_{EN} = 3V$

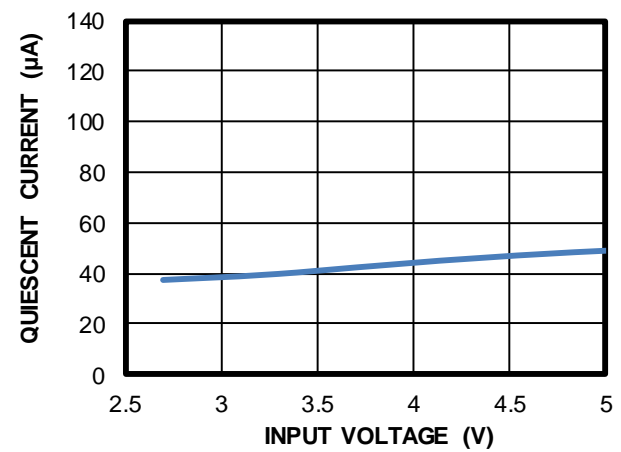

Shutdown Current vs. Input Voltage

$V_{EN} = 0V$

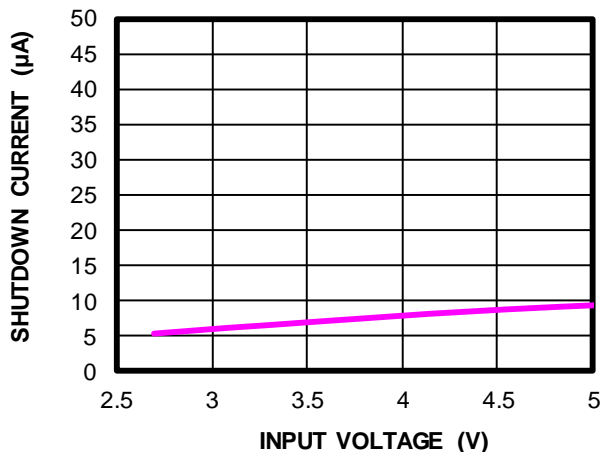

V_{IN} UVLO Rising/Falling Threshold vs. Temperature

$T_A = -40^\circ C$ to $+125^\circ C$

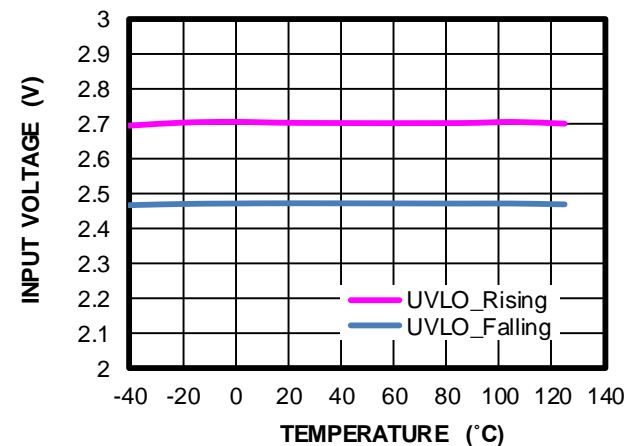

TYPICAL PERFORMANCE CHARACTERISTICS (continued)
 $V_{IN} = 5V, V_{EN} = 5V, R_{LIMIT} = 620\Omega, C_{OUT} = 10\mu F, T_A = 25^\circ C$, unless otherwise noted.

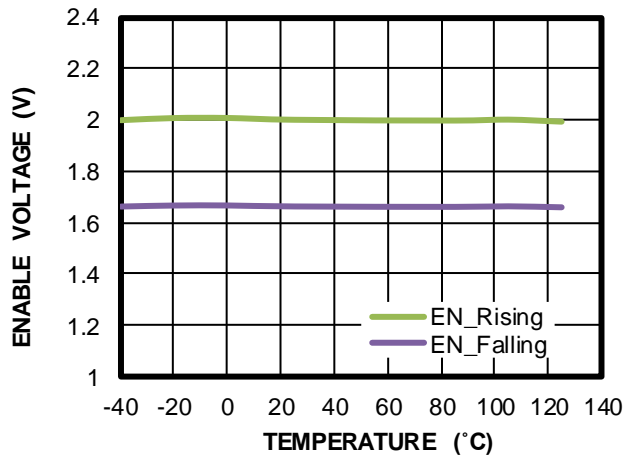
EN Rising/Falling Threshold vs. Temperature
 $T_A = -40^\circ C$ to $+125^\circ C$

TYPICAL PERFORMANCE CHARACTERISTICS (continued)
 $V_{IN} = 5V, V_{EN} = 5V, R_{LIMIT} = 620\Omega, DV/DT \text{ float}, C_{OUT} = 10\mu F, T_A = 25^\circ C$, unless otherwise noted.

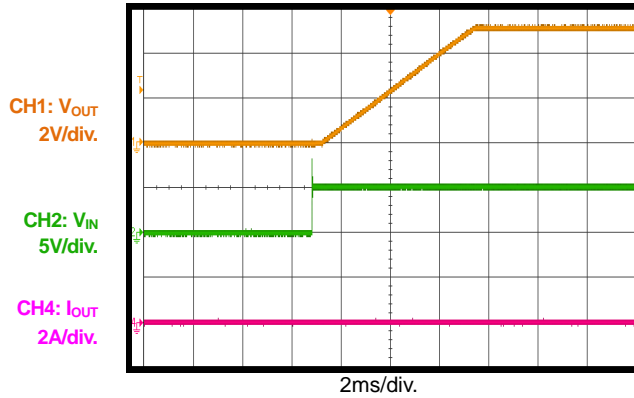
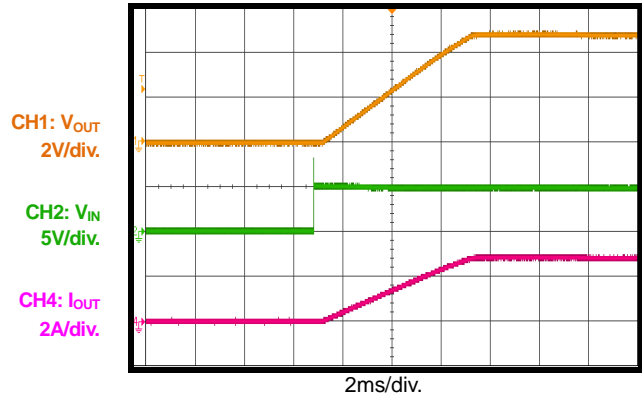
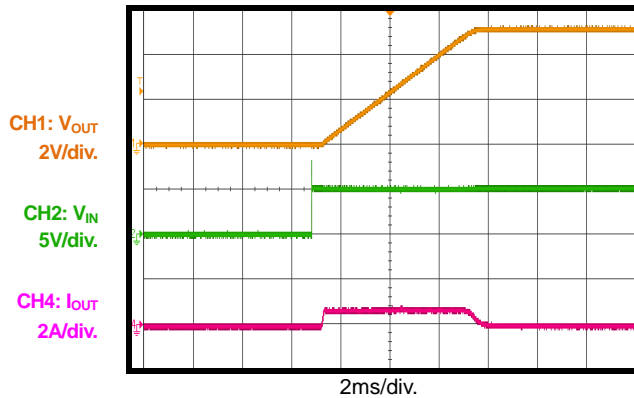
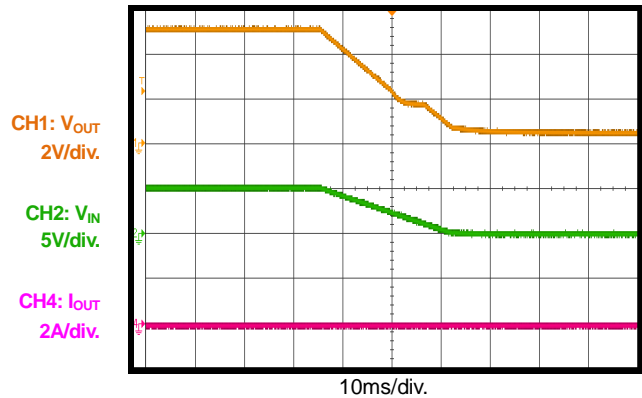
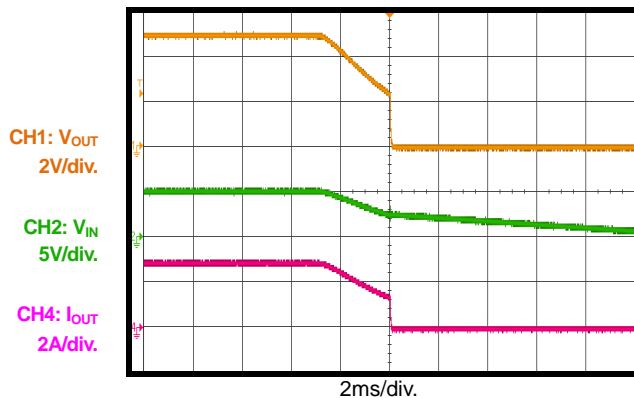
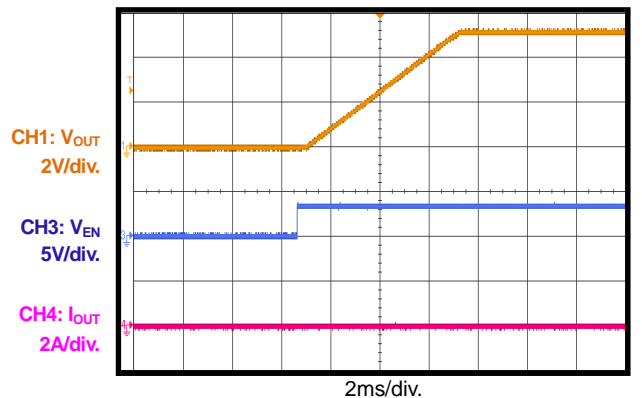
Start-Up through Input Voltage
 $I_{OUT} = 0A$

Start-Up through Input Voltage
 $I_{OUT} = 3A$

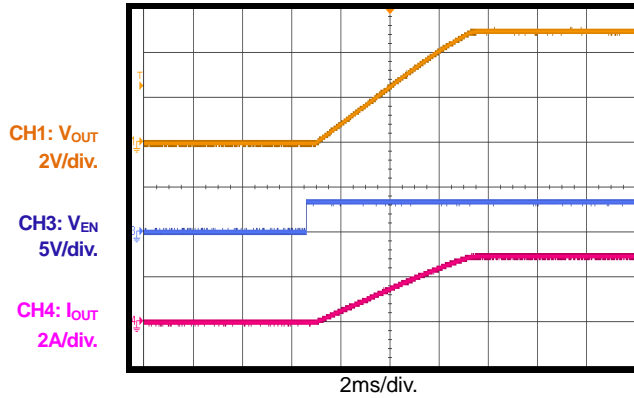
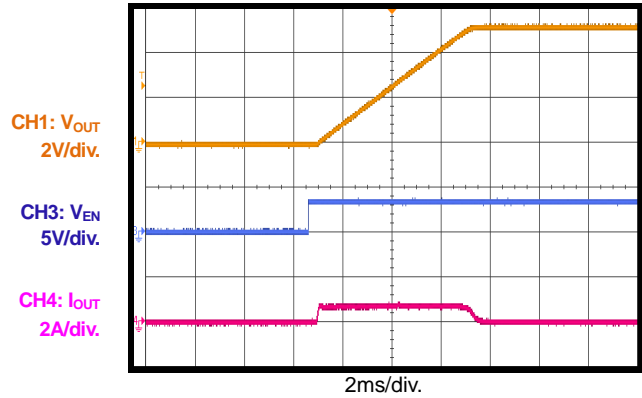
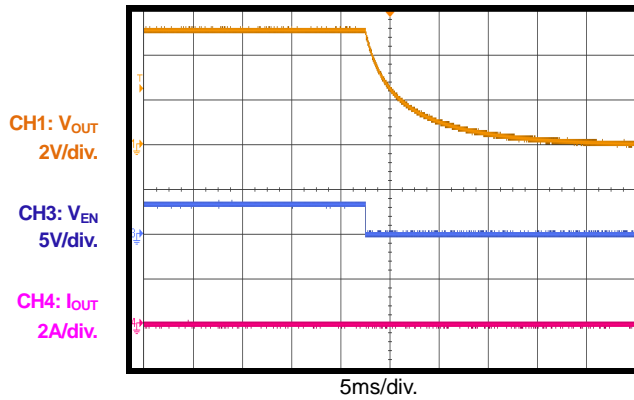
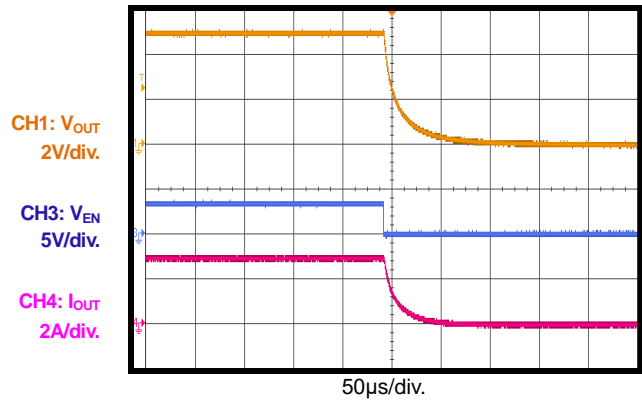
Start-Up through Input Voltage
 $I_{OUT} = 0A, C_{OUT} = 1000\mu F$

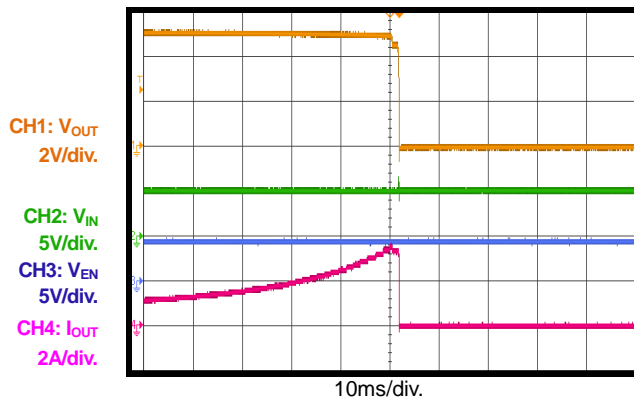
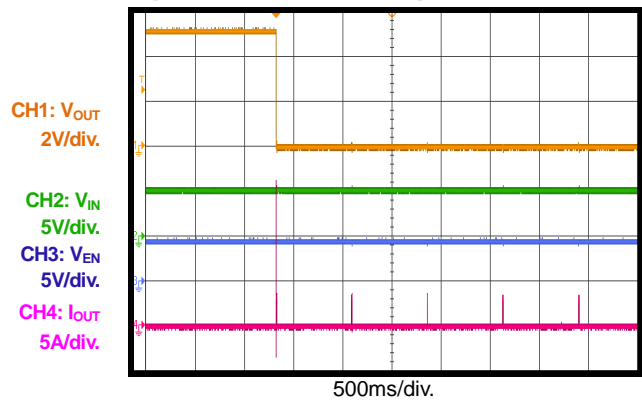
Shutdown through Input Voltage
 $I_{OUT} = 0A$

Shutdown through Input Voltage
 $I_{OUT} = 3A$

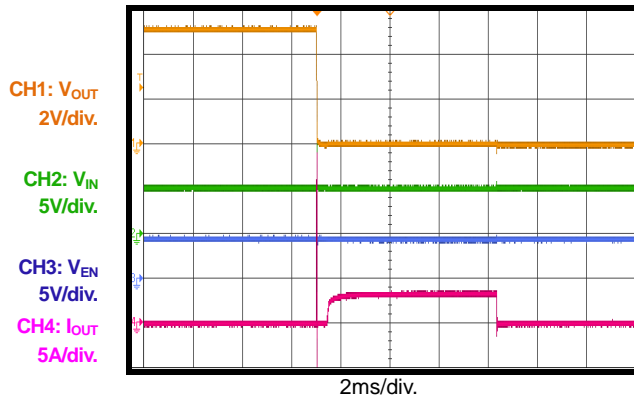
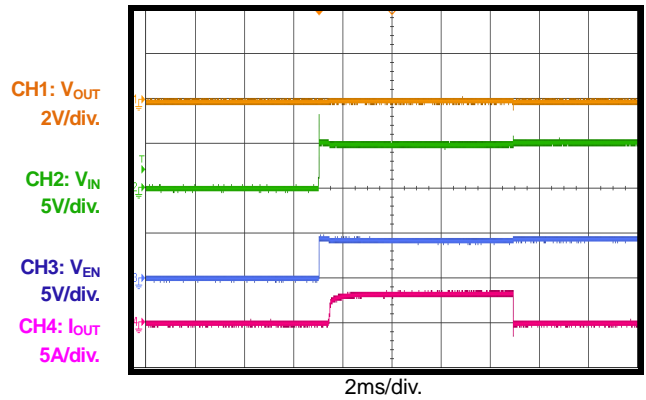
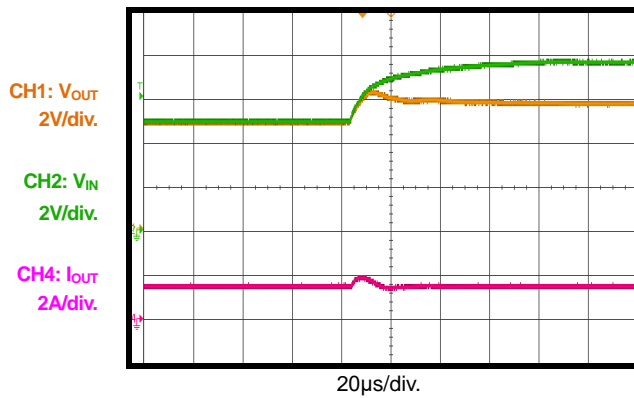
Start-Up through Enable
 $I_{OUT} = 0A$

TYPICAL PERFORMANCE CHARACTERISTICS (continued)
 $V_{IN} = 5V, V_{EN} = 5V, R_{LIMIT} = 620\Omega, DV/DT \text{ float}, C_{OUT} = 10\mu F, T_A = 25^\circ C$, unless otherwise noted.

Start-Up through Enable
 $I_{OUT} = 3A$

Start-Up through Enable
 $I_{OUT} = 0A, C_{OUT} = 1000\mu F$

Shutdown through Enable
 $I_{OUT} = 0A$

Shutdown through Enable
 $I_{OUT} = 3A$

Current Limit

 Increase I_{OUT} slowly

Short Circuit during Normal Operation and Hiccup Mode

TYPICAL PERFORMANCE CHARACTERISTICS (continued)
 $V_{IN} = 5V$, $V_{EN} = 5V$, $R_{LIMIT} = 620\Omega$, DV/DT float, $C_{OUT} = 10\mu F$, $T_A = 25^\circ C$, unless otherwise noted.

Short-Circuit Entry during Normal Operation

Short Circuit before Input Voltage Start-Up

Output Over Voltage Protection
 $V_{IN} = 5V$ to $8V$, $I_{OUT} = 1.5A$

FUNCTIONAL BLOCK DIAGRAM

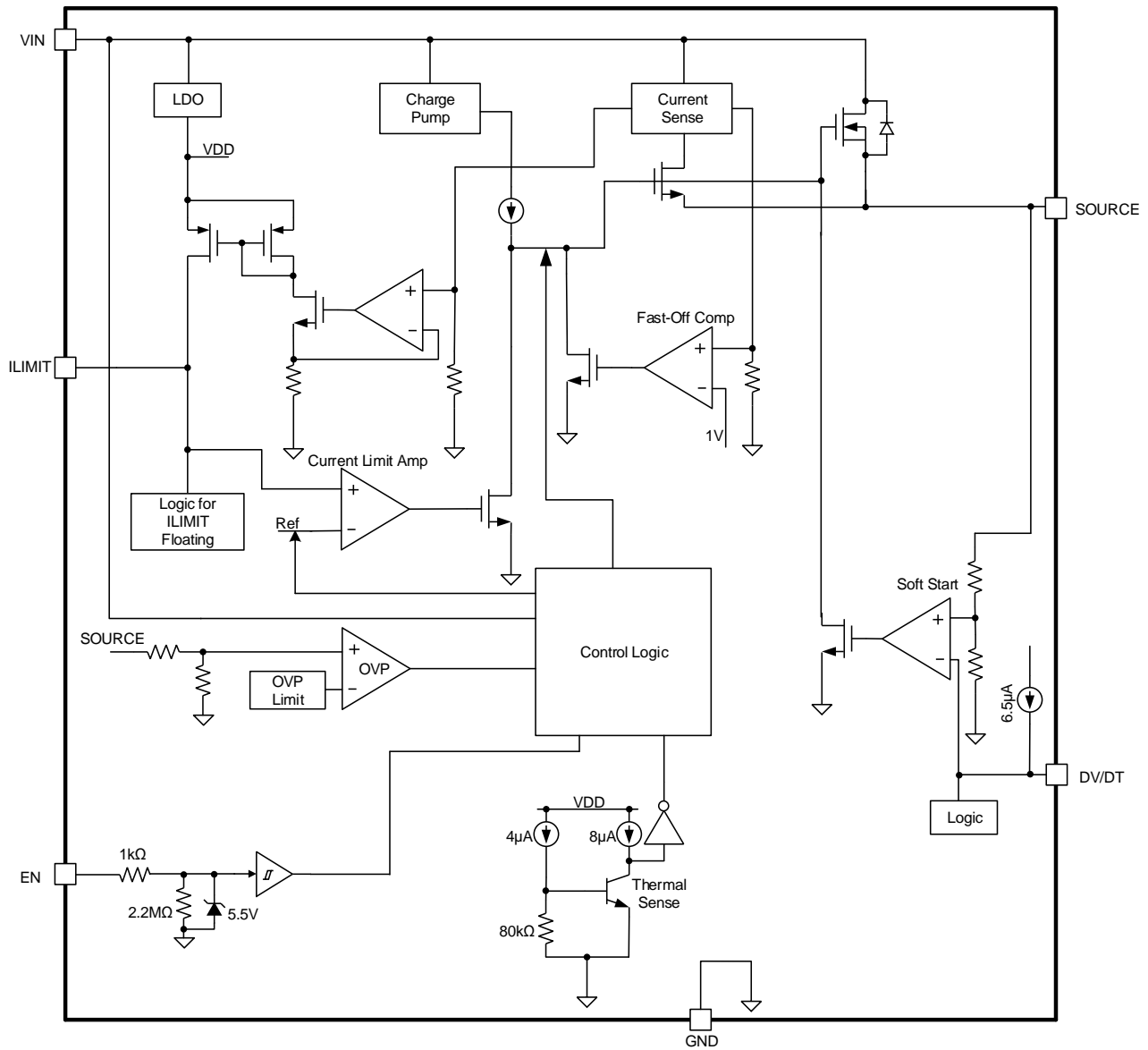

Figure 1: Functional Block Diagram

OPERATION

The MP5036A is designed to limit the inrush current to the load when a circuit card is inserted into a live backplane power source. It limits the backplane's voltage drop and the dv/dt of the voltage to the load.

The device offers an integrated solution to monitor the input voltage, output voltage, output current, and die temperature. These features eliminate the requirement for an external current-sense power resistor, a power MOSFET, and a thermal sense device.

Under-Voltage Lockout (UVLO)

The MP5036A can be used in the 2.9V to 5.5V input supply system. There are high-energy transients during normal operation or during hot swap. These transients depend on the parasitic inductance and resistance of the wire, along with the capacitor at the VIN node. If a power clamp (TVS, Tranzorb) diode is not used, the e-fuse must be able to withstand this transient voltage. The MP5036A integrates a high-voltage MOSFET with up to 5.5V of continuous voltage and 26V of maximum transient input voltage. The MP5036A also uses a high-voltage circuit for the VIN node to guarantee safe operation.

Soft-Start

The soft start relates to the dv/dt slew rate and input voltage, and it can be calculated with the Equation (1).

$$t_{ss}(\text{ms}) = \frac{V_{IN}(\text{V})}{dv/dt(\text{V/ms})} \quad (1)$$

The dv/dt slew rate is controlled by the DV/DT pin. See the Application Information section on page 13 for more details.

Fast Output Over-Voltage Protection (OVP)

To protect the downstream load when there is a voltage surge at the input, the MP5036A provides an output OVP function. An accurate and fast comparator monitors the over-voltage condition of the output. If the output voltage rises above the threshold (typically 5.75V), the gate of the internal MOSFETs quickly pull down and regulate to a certain value to keep the output voltage clamped at the OVP threshold. The fast loop response keeps the over-voltage overshoot small.

Current Limit

The MP5036A provides a constant current limit, and the current limit can be programmed by an external resistor.

The desired current limit (I_{LIMIT}) is a function of the external current limit resistor, and can be estimated with Equation (2):

$$I_{LIMIT}(\text{A}) = \frac{0.55(\text{V})}{R_{LIMIT}(\Omega)} \times 3970 \quad (2)$$

Where 3970 is the current-sense ratio.

Once the current limit threshold is reached, the internal circuit regulates the gate voltage to maintain the current in the power MOSFET. To limit the current, the gate-to-source voltage must be regulated from 5V to about 1V. The typical response time is about 15 μ s. During this period, the output current may have a small overshoot.

If the current limit condition lasts longer than 2ms, the IC enters hiccup mode with 700ms of off time.

The MP5036A allows I_{LIMIT} to be floated during operation. If I_{LIMIT} is floating, the current limit is internally fixed at 2.5A.

When shorting I_{LIMIT} to GND, the normal current limit is disabled, but the secondary current limit still works. The secondary current limit is internally set to 8A. When the secondary current limit is triggered, the IC shuts down the power MOSFET.

Short-Circuit Protection (SCP)

If the load current increases rapidly during a short-circuit event, the current may exceed the current limit threshold before the control loop responds. If the current reaches the 8A secondary current limit level, a fast turn-off circuit activates to turn off the power MOSFET. This limits the peak current through the switch and prevents the input voltage from dropping. The total short circuit response time is about 1 μ s. When the MOSFET switches off, the part restarts. If the short still exists during the restart process, the MP5036A regulates the gate voltage to hold the current at the normal current limit level. The IC enters hiccup mode with 700ms of off time.

To prevent safe operating area (SOA) damage during a high input voltage short-circuit protection (SCP) condition, the IC current limit folds back

when the power MOSFET V_{DS} voltage is above the typical 11V and the junction temperature exceeds 110°C.

Output Discharge

The MP5036A has a discharge function that provides a resistive discharge path for the external output capacitor. This function is active when the part is disabled (V_{IN} UVLO, EN shutdown), and is done in a limited time.

Enable (EN)

The MP5036A enables when EN is high. The MP5036A disables when EN is low. Floating the EN pin shuts down the MP5036A because there is an internal 2.2MΩ resistor pulling EN down to ground. For automatic start-up, connect a pull-up resistor from V_{IN} to EN.

EN is internally clamped using a 5.5V Zener diode (see Figure 2). Connecting the EN input through a pull-up resistor to V_{IN} limits the EN input current below 100μA to prevent damage to the Zener diode. For example, when connecting a 300kΩ pull-up resistor to 12V V_{IN} , $I_{Zener} = (12V - 5.5V) / 300k\Omega - 5.5V / 2.2M\Omega = 19\mu A$.

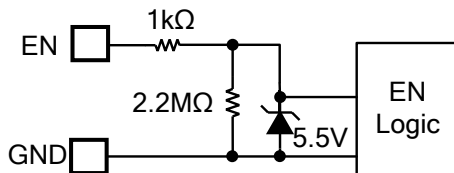

Figure 2: Zener Diode between EN and GND

When using a pull-up resistor to set the power-on threshold, do not use a pull-up resistor that is too small and unable to increase the operation quiescent current.

Thermal Shutdown and Auto-Retry

Thermal shutdown prevents the chip from operating at exceedingly high temperatures. When the silicon die temperature exceeds 175°C, the entire chip shuts down. When the temperature drops below its lower threshold (typically 125°C), the chip enables again after a 700ms delay.

APPLICATION INFORMATION

Setting the Current Limit

The MP5036A's current limit value should exceed the normal maximum load current, allowing for tolerances in the current sense value. The current limit is a function of the external current limit resistor (see Table 1).

Table 1: Typical Current Limit vs. Current Limit Resistor ⁽⁸⁾

R_{LIMIT} (Ω)	3k	1.1k	620	475
I_{LIMIT} (A)	0.75	2	3.5	4.5

Note:

8) The current limit in Table 1 is a typical value for the reference design.

Figure 3 shows the relationship between current limit (I_{LIMIT}) and resistor limit (R_{LIMIT}).

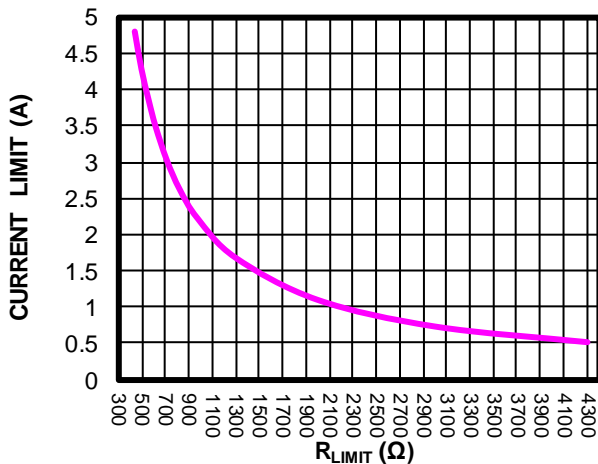

Figure 3: Current Limit vs. Current Limit Resistor

The MP5036A's current limit can be programmed from 0.4A to 5A by connecting to the R_{LIMIT} resistor. Because the device works in sleep mode when the load falls below 0.23A, it is recommended the current limit not be set too low. The current limit logic is disabled in sleep mode.

Setting the Soft Start Time

The soft-start time is related to the dv/dt slew rate and input voltage, and can be calculated with Equation (3):

$$t_{ss}(\text{ms}) = \frac{V_{IN}(\text{V})}{dv/dt(\text{V/ms})} \quad (3)$$

The dv/dt slew rate is controlled by the external DV/DT capacitor setting.

When DV/DT is floating, the dv/dt slew rate is 0.8V/ms.

For cases with an external DV/DT capacitor, the dv/dt slew rate can be calculated with Equation (4):

$$dv/dt(\text{V/ms}) = \frac{6.5(\mu\text{A}) \times 5.75}{C_{DV/DT}(\text{nF})} \quad (4)$$

For example, when the external DV/DT capacitor is 47nF, the dv/dt slew rate is 0.8V/ms.

Design Example

Table 2 is a design example following the application guidelines for the given specifications:

Table 2: Design Example

V_{IN} (V)	5
Current Limit (A)	3.5
DV/DT Slew Rate (V/ms)	0.8

Figure 5 shows the detailed application circuit. For the typical performance and circuit waveforms the Typical Performance Characteristics section on page 5. For more detailed device applications, refer to the related evaluation board datasheet.

PCB Layout Guidelines

PCB layout is critical for improved performance. For the best results, refer to Figure 4 and follow the guidelines below:

1. Place the high-current paths (VIN and VOUT) close to the device using short, direct, and wide traces.
2. Place the input capacitors close to the VIN and GND pins.
3. To improve thermal performance, connect the VIN and VOUT pads to large VIN and VOUT planes, respectively.
4. Place a current limit resistor close to the ILIMIT pin.
5. Place a DV/DT capacitor close to the DV/DT pin.

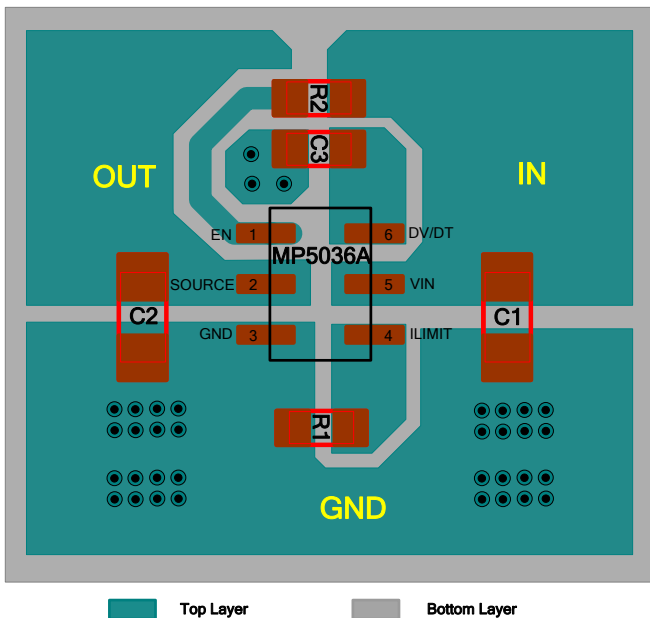

Figure 4: Recommended PCB Layout

TYPICAL APPLICATION CIRCUIT

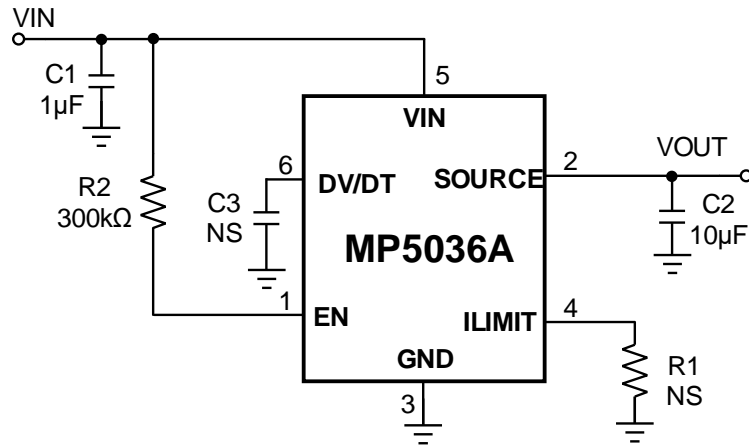
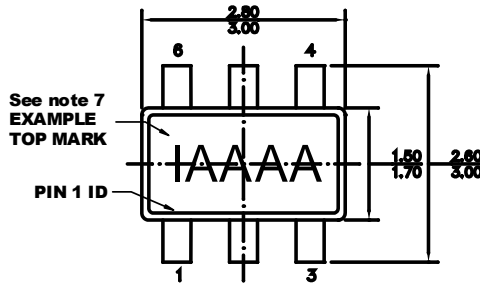

Figure 5: Typical Application Circuit

PACKAGE INFORMATION

TSOT23-6



TOP VIEW

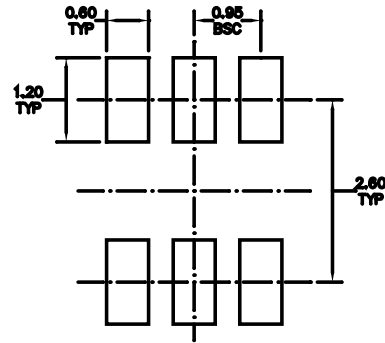

RECOMMENDED LAND PATTERN

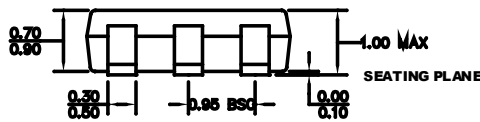

FRONT VIEW

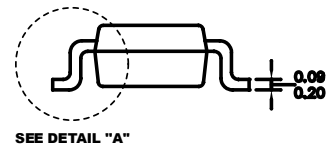

SIDE VIEW

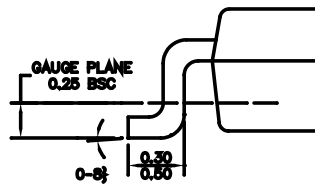

DETAIL "A"

NOTE:

- 1) ALL DIMENSIONS ARE IN MILLIMETERS.
- 2) PACKAGE LENGTH DOES NOT INCLUDE MOLD FLASH, PROTRUSION, OR GATE BURR.
- 3) PACKAGE WIDTH DOES NOT INCLUDE INTERLEAD FLASH OR PROTRUSION.
- 4) LEAD COPLANARITY (BOTTOM OF LEADS AFTER FORMING) SHOULD BE 0.10 MILLIMETERS MAX.
- 5) DRAWING CONFORMS TO JEDEC MO-193, VARIATION AB.
- 6) DRAWING IS NOT TO SCALE.
- 7) PIN 1 IS THE LOWER-LEFT PIN WHEN READING TOP MARK FROM LEFT TO RIGHT (SEE EXAMPLE TOP MARK).

Notice: The information in this document is subject to change without notice. Users should warrant and guarantee that third-party Intellectual Property rights are not infringed upon when integrating MPS products into any application. MPS will not assume any legal responsibility for any said applications.