

DESCRIPTION

The MP8101 is a rail-to-rail output, operational amplifier in a TSOT-23 package. This amplifier provides 400kHz bandwidth while consuming an incredibly low 11µA of supply current. The MP8101 can operate with a single supply voltage as low as 1.8V.

FEATURES

- Single Supply Operation: 1.8V to 5.5V
- TSOT23-5 Package
- 400kHz Gain Bandwidth
- 11µA Supply Current
- Rail-to-Rail Output
- Unity-Gain Stable
- Input Common Mode to Ground
- Drives Up to 1000pF of Capacitive Loads

APPLICATIONS

- Portable Equipment
- PDAs
- Pagers
- Cordless Phones
- Handheld GPS
- Consumer Electronics

All MPS parts are lead-free, halogen free, and adhere to the RoHS directive. For MPS green status, please visit MPS website under Quality Assurance. "MPS" and "The Future of Analog IC Technology" are Registered Trademarks of Monolithic Power Systems, Inc.

TYPICAL APPLICATION

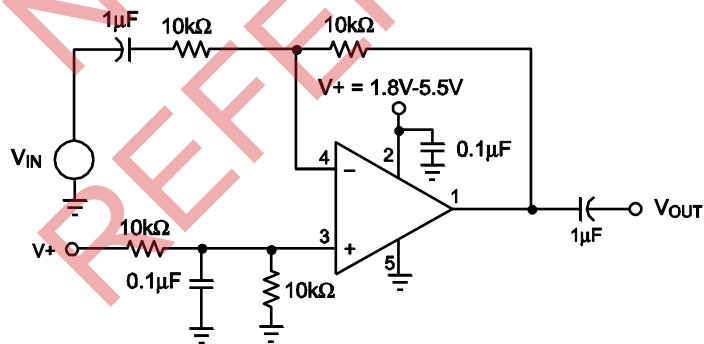

ORDERING INFORMATION

Part Number*	Package	Top Marking
MP8101DJ	TSOT23-5	See Below

* For Tape & Reel, add suffix -Z (e.g. MP8101DJ-Z);
 For RoHS, compliant packaging, add suffix -LF (e.g. MP8101DJ-LF-Z).

TOP MARKING

|H5YW

H5: product code of MP8101DJ;
 Y: year code;
 W: week code:

PACKAGE REFERENCE

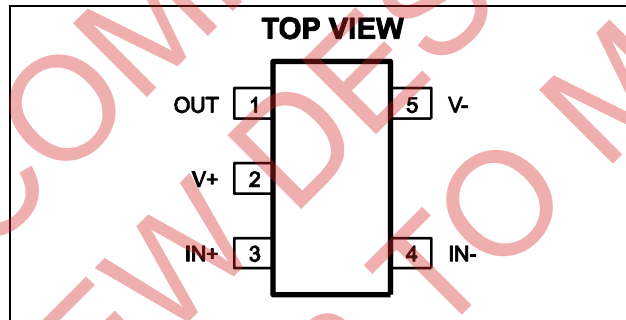

ABSOLUTE MAXIMUM RATINGS ⁽¹⁾

Supply Voltage (V+ to V-)+6.0V
 Differential Input Voltage ($V_{IN+} - V_{IN-}$).....+6.0V
 Input Voltage ($V_{IN+} - V_{IN-}$).. $V_{IN+} + 0.3V$, $V_{IN-} - 0.3V$
 Junction Temperature 150°C

Recommended Operating Conditions ⁽²⁾

Supply Voltage +1.8V to +5.5V
 Operating Temperature..... -40°C to +85°C

Thermal Resistance ⁽³⁾	θ_{JA}	θ_{JC}
TSOT23-5	220	110 .. °C/W

Notes:

- 1) Exceeding these ratings may damage the device.
- 2) The device is not guaranteed to function outside of its operating conditions.
- 3) Measured on approximately 1" square of 1 oz copper.

ELECTRICAL CHARACTERISTICS

$V_+ = +5V$, $V_- = 0V$, $V_{CM} = V_+/2$, $R_L = 10k\Omega$, $T_A = +25^\circ C$, unless otherwise noted.

Parameter	Symbol	Condition	Min	Typ	Max	Units
Input Offset Voltage	V_{OS}		-5	1	+5	mV
Input Offset Voltage Temp Coefficient				15		$\mu V/^\circ C$
Input Bias Current ⁽⁴⁾	I_B			2		pA
Input Offset Current ⁽⁴⁾	I_{OS}			0.2		pA
Input Voltage Range	V_{CM}	CMRR > 60dB	0		3.8	V
Common-Mode Rejection Ratio	CMRR	$0 < V_{CM} < 3.5V$		82		dB
Power Supply Rejection Ratio	PSRR	Supply Voltage change of 1.0V		80		dB
Large Signal Voltage Gain	A_{VOL}	$R_L = 100k\Omega$, $V_{OUT} = 5.0$ Peak to Peak	60	88		dB
Maximum Output Voltage Swing	V_{OUT}	$R_L = 10k\Omega$		$(V_+) - 23mV$		V
Minimum Output Voltage Swing	V_{OUT}	$R_L = 10k\Omega$		$(V_-) + 19mV$		V
Gain-Bandwidth Product ⁽⁴⁾	GBW	$R_L = 200k\Omega, C_L = 2pF$, $V_{OUT} = 0$		400		KHz
-3dB Bandwidth ⁽⁴⁾	BW	$A_V = 1, C_L = 2pF$, $R_L = 1M\Omega$		1		MHz
Slew Rate ⁽⁴⁾	SR	$A_V = 1, C_L = 2pF$, $R_L = 1M\Omega$		0.2		V/ μs
Short Circuit Current	I_{SC}	Source		20		mA
		Sink		20		mA
Supply Current		No Load		11	20	μA

Note:

4) Guaranteed by design.

PIN FUNCTIONS

Pin #	Name	Description
1	OUT	Output.
2	V+	Supply Voltage.
3	IN+	Non-Inverting Input.
4	IN-	Inverting Input.
5	V-	Ground or Supply Return Pin.

TEST CIRCUITS

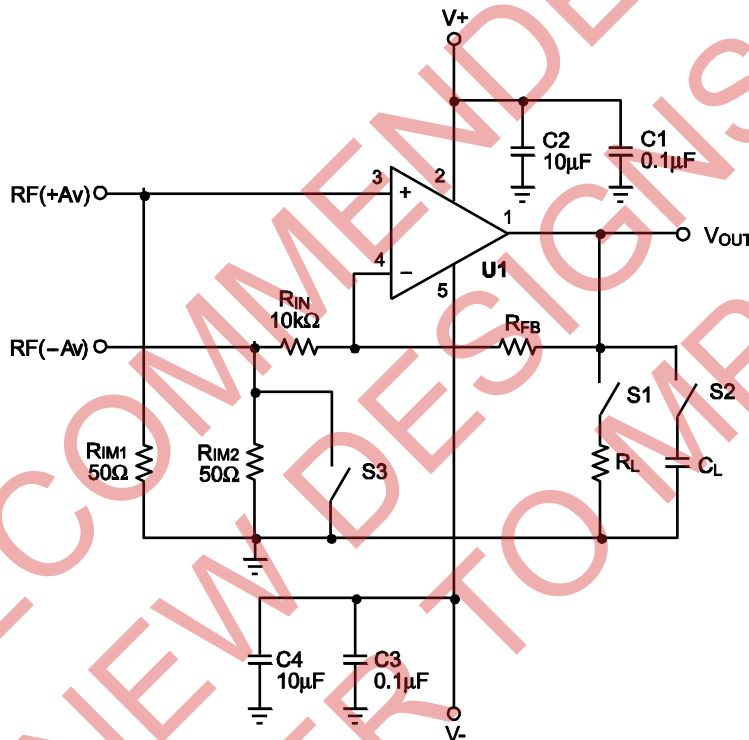

Notes: Close S3 for positive gain. Input signal to RF(+Av) connector.
 The gain $A_v = 1 + R_{FB}/R_{IN}$.
 For unity gain, remove R_{IN} and short R_{FB} .
 Open S3 for negative gain. Input signal to RF(-Av) connector.
 The gain $A_v = -R_{FB}/R_{IN}$.
 S1 and S2 are switches for possible resistor and capacitor load connections.

Figure 1—AC Test Circuit

TEST CIRCUITS (continued)

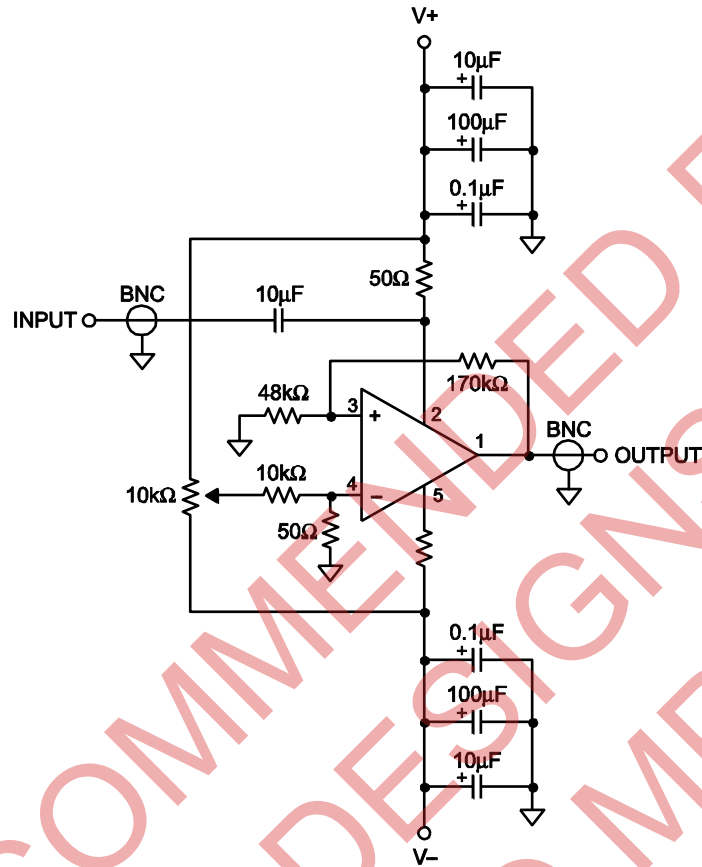
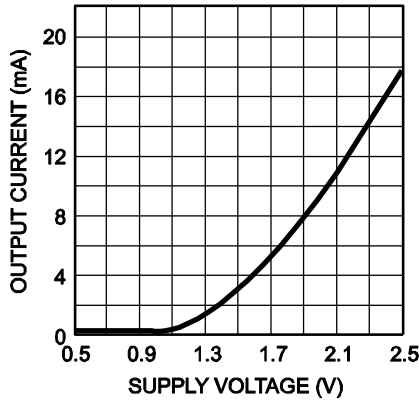

Figure 2—Positive Power Supply Rejection Ratio Measurement

TYPICAL PERFORMANCE CHARACTERISTICS

T_A = +25°C, unless otherwise noted.

Short Circuit Current vs Supply Voltage
Sourcing



Short Circuit Current vs Supply Voltage
Sinking

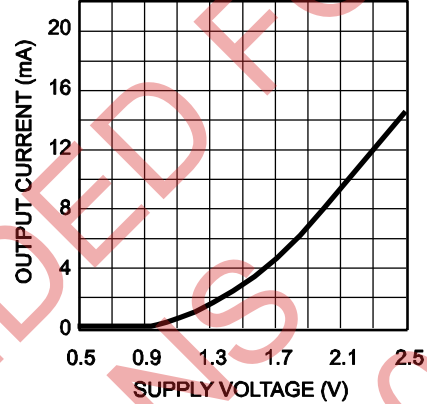

Offset Voltage vs. Common Mode Voltage
R_{FB} = 50kΩ, V₋ = -5V to 0V,
V₊ = 0V to +5V

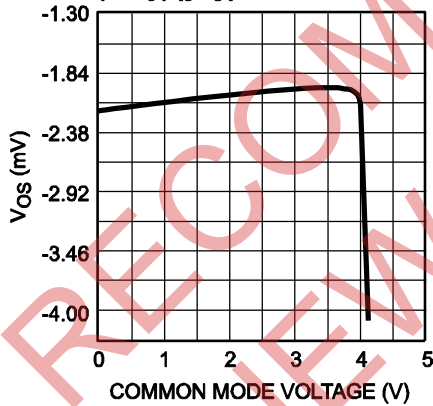

Offset Voltage vs. Supply Voltage
R_{FB} = 50kΩ, V₋ = -2.5V to 0V,
V₊ = +2.5V to 0V

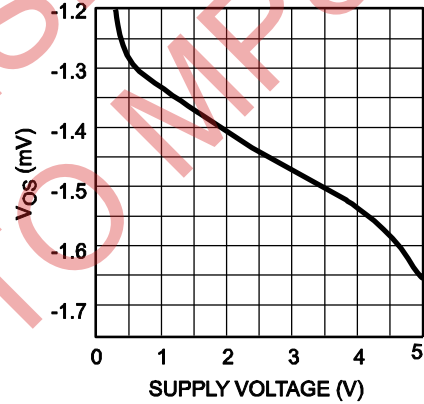

Output Noise vs. Frequency

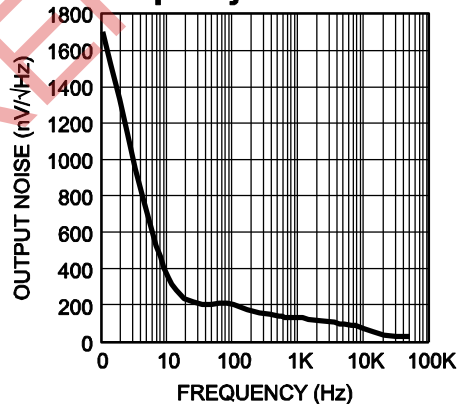

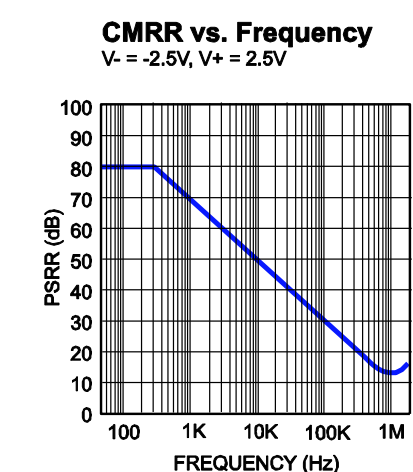
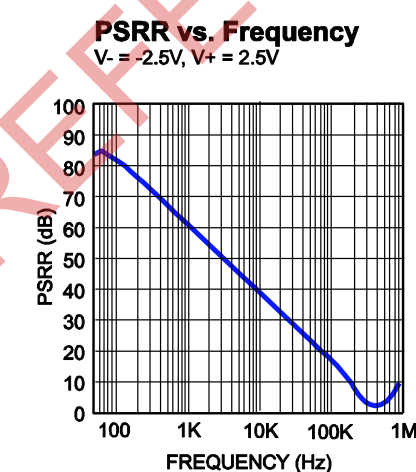
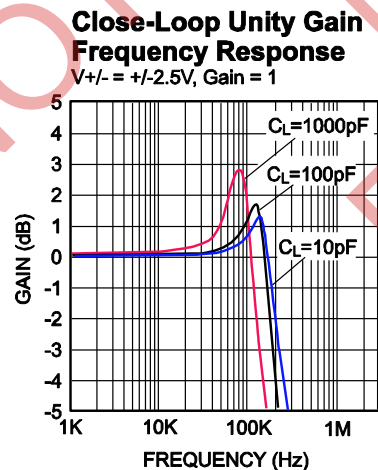
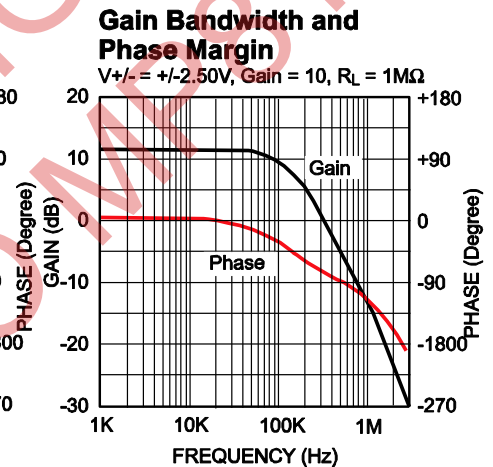
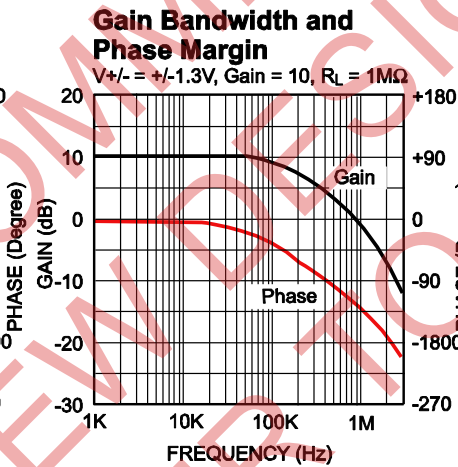
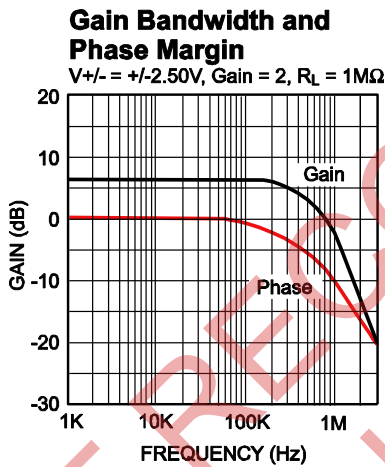
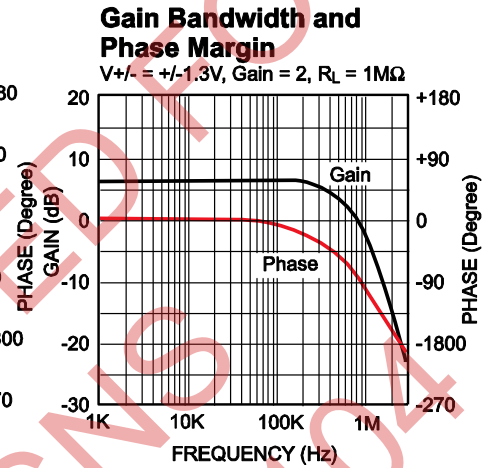
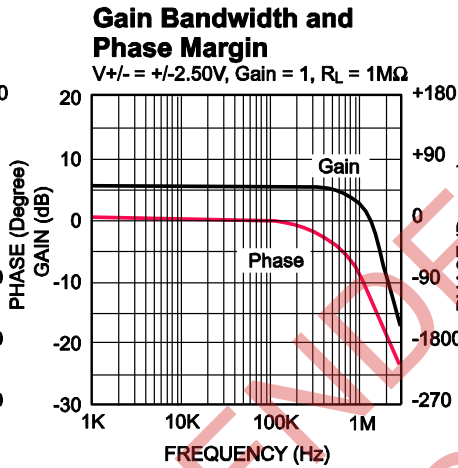
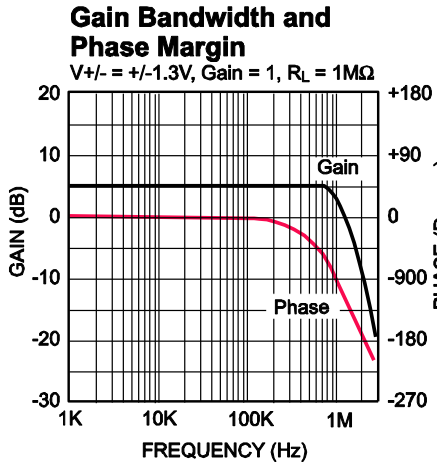
TYPICAL PERFORMANCE CHARACTERISTICS (continued)
 $T_A = +25^{\circ}\text{C}$, unless otherwise noted.

TYPICAL PERFORMANCE CHARACTERISTICS (continued)

T_A = +25°C, unless otherwise noted.

Small Signal Pulse Response

A_v = 1, V₊ = 2.5V, V₋ = -2.5V
R_L = 1MΩ, C_L = 8pF

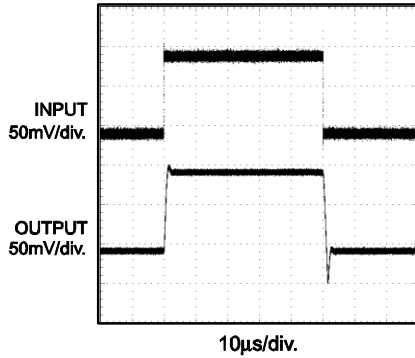

Small Signal Pulse Response

A_v = 1, V₊ = 1.3V, V₋ = -1.3V
R_L = 1MΩ, C_L = 8pF

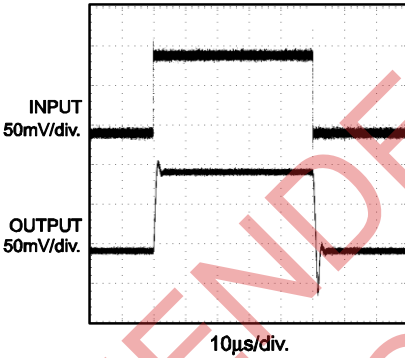

Small Signal Pulse Response

A_v = 1, V₊ = 2.5V, V₋ = -2.5V
R_L = 1MΩ, C_L = 47pF

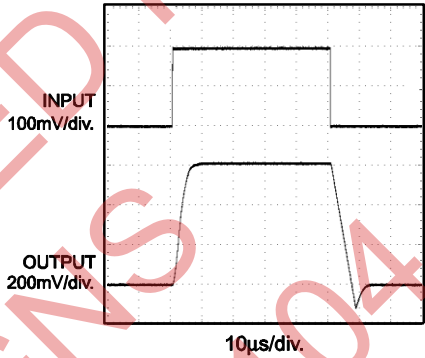

Small Signal Pulse Response

A_v = 1, V₊ = 1.3V, V₋ = -1.3V
R_L = 1MΩ, C_L = 47pF

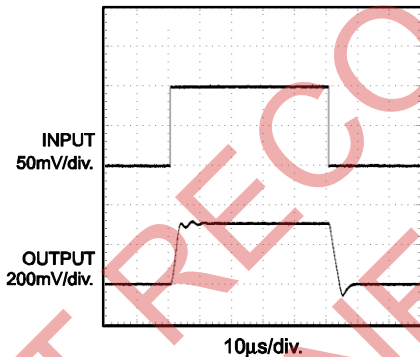

Small Signal Pulse Response

A_v = -1, V₊ = 2.5V, V₋ = -2.5V
R_L = 1MΩ, C_L = 8pF

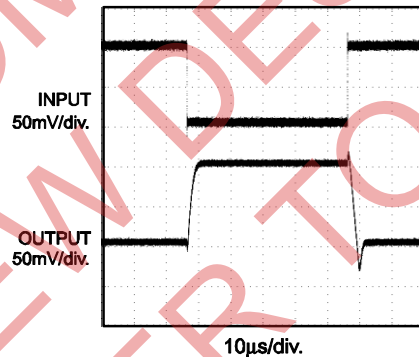

Small Signal Pulse Response

A_v = -1, V₊ = 1.3V, V₋ = -1.3V
R_L = 1MΩ, C_L = 8pF

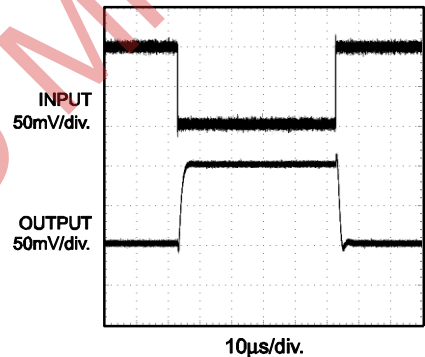

Small Signal Pulse Response

A_v = -1, V₊ = 2.5V, V₋ = -2.5V
R_L = 4.7kΩ, C_L = 8pF

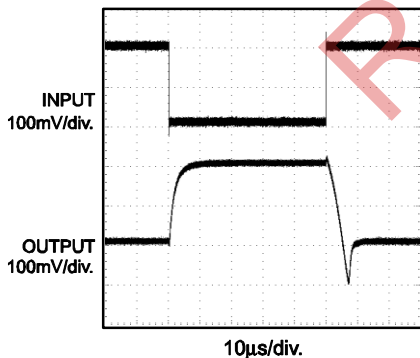

Small Signal Pulse Response

A_v = -1, V₊ = 1.3V, V₋ = -1.3V
R_L = 4.7kΩ, C_L = 8pF

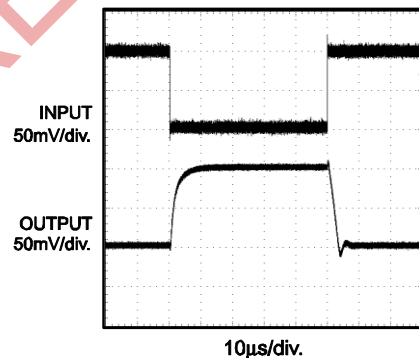

TYPICAL PERFORMANCE CHARACTERISTICS (continued)
 $T_A = +25^\circ\text{C}$, unless otherwise noted.

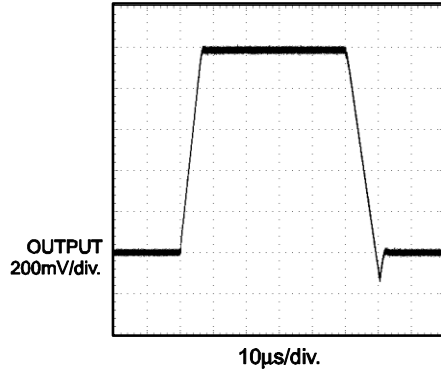
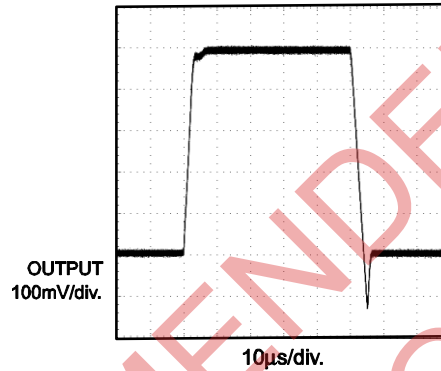
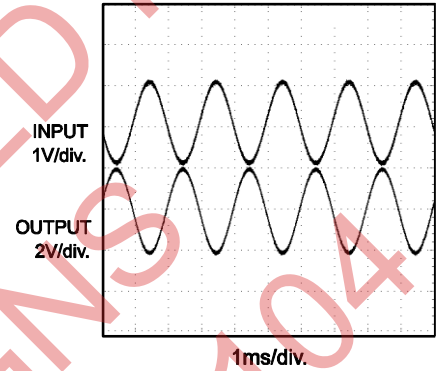
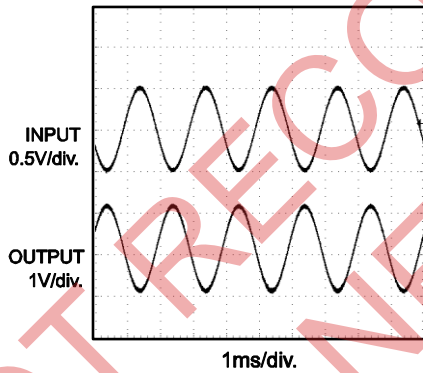
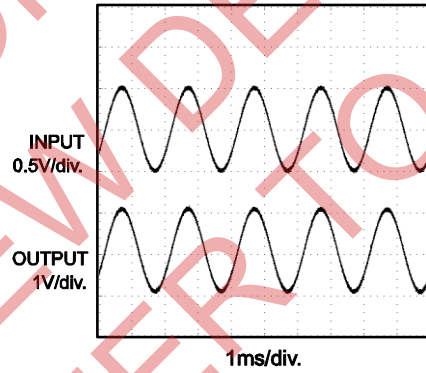
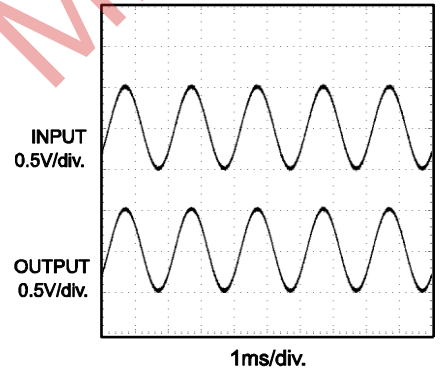
Large Signal Pulse Response
 $A_V = 1$, $V_+ = 2.5\text{V}$, $V_- = -2.5\text{V}$
 $R_L = 1\text{M}\Omega$, $C_L = 8\text{pF}$

Large Signal Pulse Response
 $A_V = 1$, $V_+ = 1.3\text{V}$, $V_- = -1.3\text{V}$
 $R_L = 1\text{M}\Omega$, $C_L = 8\text{pF}$

Rail to Rail Output Operation
 $A_V = -2$, $V_+ = 2.5\text{V}$, $V_- = -2.5\text{V}$
 $R_L = 1\text{M}\Omega$, $C_L = 50\text{pF}$

Rail to Rail Output Operation
 $A_V = -2$, $V_+ = 1.3\text{V}$, $V_- = -1.3\text{V}$
 $R_L = 1\text{M}\Omega$, $C_L = 50\text{pF}$

Rail to Rail Output Operation
 $A_V = 2$, $V_+ = 2.5\text{V}$, $V_- = -2.5\text{V}$
 $R_L = 1\text{M}\Omega$, $C_L = 8\text{pF}$

Rail to Rail Output Operation
 $A_V = 2$, $V_+ = 1.3\text{V}$, $V_- = -1.3\text{V}$
 $R_L = 1\text{M}\Omega$, $C_L = 8\text{pF}$

APPLICATION INFORMATION

Power Supply Bypassing

Regular supply bypassing techniques are recommended. A 10µF capacitor in parallel with a 0.1µF capacitor on both the positive and negative supplies is ideal. For the best performance, all bypassing capacitors should

be located as close to the op amp as possible and all capacitors should be low ESL (Equivalent Series Inductance) and low ESR (Equivalent Series Resistance). Surface mount ceramic capacitors are ideal

TYPICAL APPLICATION CIRCUIT

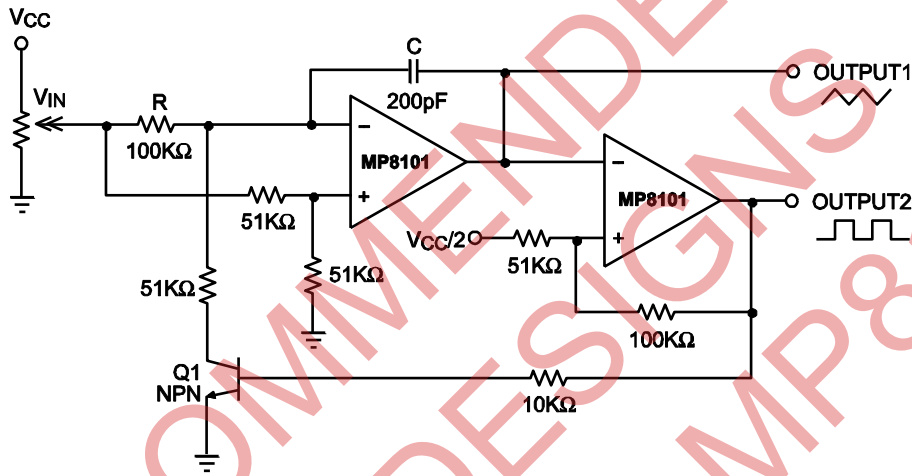

- Notes:
- 1) The control voltage V_{IN} is wide, $0 < V_{IN} < V_{CC} - 1V$
 - 2) The switch frequency can be changed by adjusting R and C.

Figure 3—Voltage Controlled Frequency Circuit

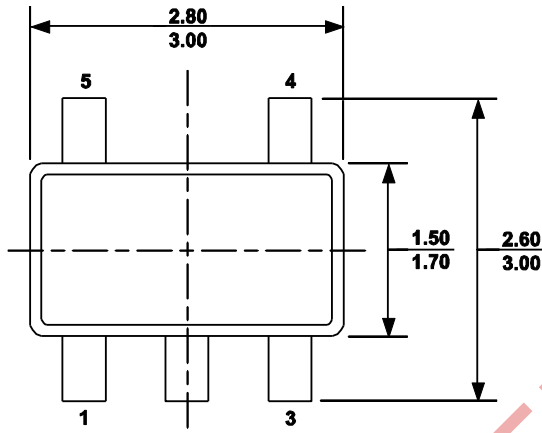
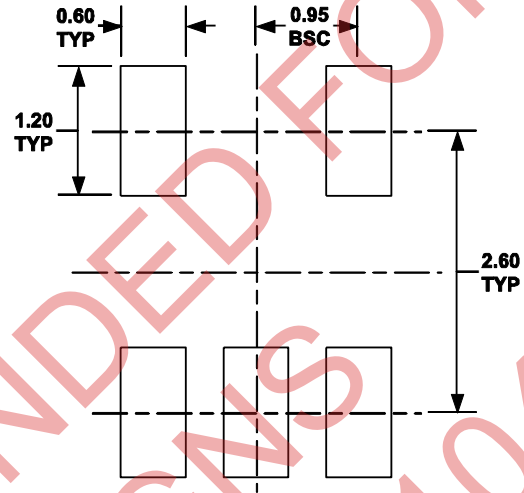
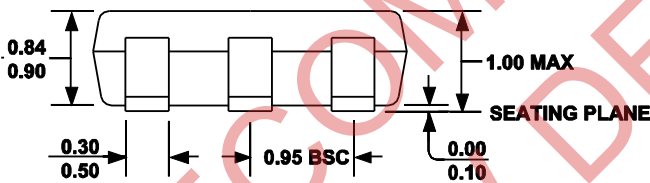
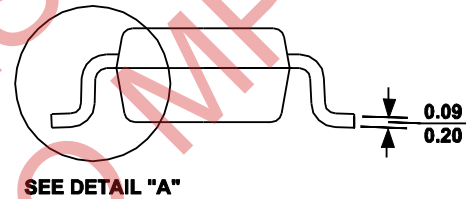
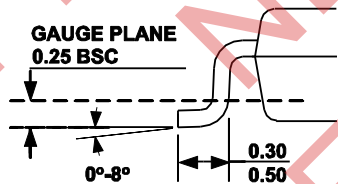
PACKAGE INFORMATION
TSOT23-5

TOP VIEW

RECOMMENDED LAND PATTERN

FRONT VIEW

SIDE VIEW

DETAIL "A"
NOTE:

- 1) ALL DIMENSIONS ARE IN MILLIMETERS.
- 2) PACKAGE LENGTH DOES NOT INCLUDE MOLD FLASH, PROTRUSION OR GATE BURR.
- 3) PACKAGE WIDTH DOES NOT INCLUDE INTERLEAD FLASH OR PROTRUSION.
- 4) LEAD COPLANARITY (BOTTOM OF LEADS AFTER FORMING) SHALL BE 0.10 MILLIMETERS MAX.
- 5) DRAWING CONFORMS TO JEDEC MO-193, VARIATION AA.
- 6) DRAWING IS NOT TO SCALE.

NOTICE: The information in this document is subject to change without notice. Users should warrant and guarantee that third party Intellectual Property rights are not infringed upon when integrating MPS products into any application. MPS will not assume any legal responsibility for any said applications.