



MPQ4573

60V, 2.5A, Fully Integrated, High-Efficiency, Synchronous Step-Down Converter, AEC-Q100 Qualified

DESCRIPTION

The MPQ4573 is a fully integrated, fixed-frequency, synchronous step-down converter. It can achieve up to 2.5A of continuous output current with peak current control for excellent transient response.

The wide 4.5V to 60V input voltage range accommodates a variety of step-down applications in an automotive input environment. The device's 2 μ A shutdown current makes it ideal for battery-powered applications.

The MPQ4573's integrated internal high-side and low-side power MOSFETs (HS-FET and LS-FET, respectively) provide high efficiency without the need for an external Schottky diode. Advanced asynchronous modulation (AAM) mode achieves high efficiency under light-load conditions by scaling down the frequency to reduce switching and gate driver losses.

Features include built-in soft start (SS), enable (EN) control, and power good (PG) indication. High-duty cycle and low-dropout (LDO) mode enable the device to withstand automotive cold crank conditions.

The MPQ4573 employs over-current protection (OCP) with valley current detection to avoid current runaway. It also features short-circuit protection (SCP) with hiccup mode, input under-voltage lockout (UVLO), and auto-recovery thermal protection.

With internal compensation, the MPQ4573 offers a compact solution that requires a minimal number of readily available, standard external components. It is available in a QFN-12 (2.5mmx3mm) package.

FEATURES

- Wide 4.5V to 60V Operating Input Range
- 2.5A Continuous Output Current (I_{OUT})
- High-Efficiency, Synchronous Mode Control
- 250m Ω /45m Ω Internal Power MOSFETs
- Up to 2.2MHz Configurable Frequency
- 180° Out-of-Phase SYNCO Clock
- 40 μ A Quiescent Current (I_Q)
- Low 2 μ A Shutdown Current
- FB Tolerance: 1% at Room Temperature, 2% across the Full Temperature Range (-40°C to +125°C)
- Selectable Advanced Asynchronous Modulation (AAM) Mode or Forced Continuous Conduction Mode (FCCM) during Light-Load Operation
- 0.45ms Internal Soft Start (SS)
- Remote Enable (EN) Control
- Power Good (PG) Indicator
- Low-Dropout (LDO) Mode
- Over-Current Protection (OCP)
- Short-Circuit Protection (SCP) with Hiccup Mode
- V_{IN} Under-Voltage Lockout (UVLO)
- Thermal Shutdown
- Available in a QFN-12 (2.5mmx3mm) Package
- Available in a Wettable Flank Package
- Available in AEC-Q100 Grade 1

APPLICATIONS

- Automotive Infotainment Systems
- Automotive Lamps and LEDs
- Automotive Motor Control
- Industrial Power Systems

All MPS parts are lead-free, halogen-free, and adhere to the RoHS directive. For MPS green status, please visit the MPS website under Quality Assurance. "MPS", the MPS logo, and "Simple, Easy Solutions" are trademarks of Monolithic Power Systems, Inc. or its subsidiaries.

TYPICAL APPLICATION

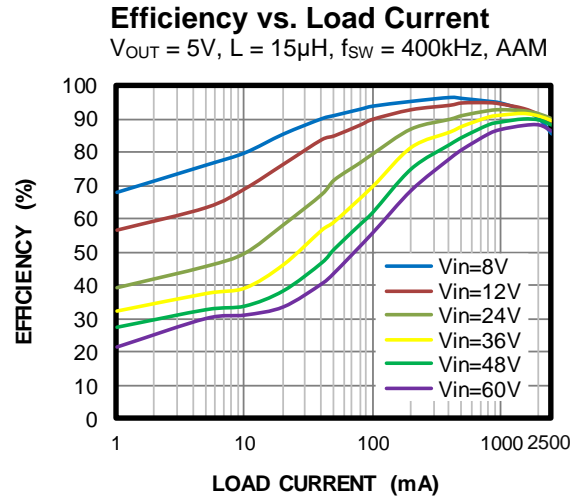
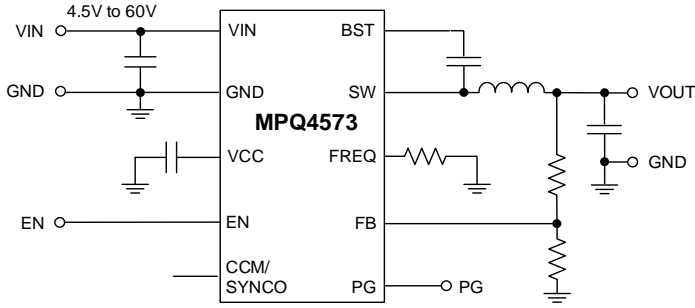

ORDERING INFORMATION

Part Number*	Package	Top Marking	MSL Rating**
MPQ4573GQBE***	QFN-12 (2.5mmx3mm)	See Below	1
MPQ4573GQBE-AEC1***			

* For Tape & Reel, add suffix -Z (e.g. MPQ4573GQBE-Z).

** Moisture sensitivity level rating.

*** Wettable flank.

TOP MARKING

BQN

YWW

LLL

BQN: Product code of MPQ4573GQBE and MPQ4573GQBE-AEC1

Y: Year code

WW: Week code

LLL: Lot number

PACKAGE REFERENCE

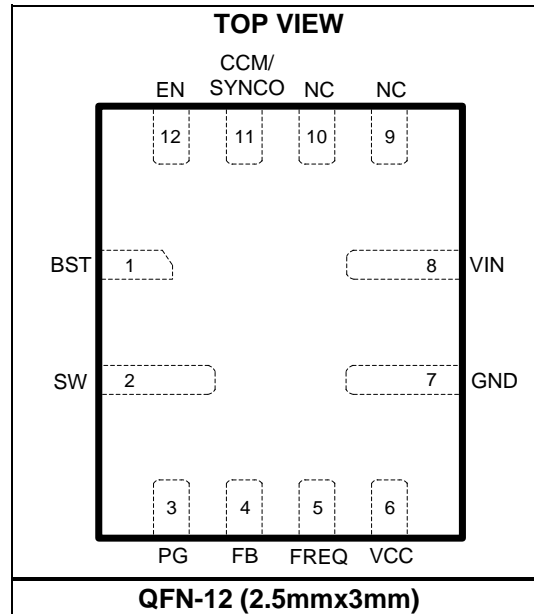

PIN FUNCTIONS

Pin #	Name	Description
1	BST	Bootstrap. Connect a capacitor between the SW and BST pins to form a floating supply across the high-side MOSFET (HS-FET) driver.
2	SW	Switch output. The SW pin is the output of the internal power switches.
3	PG	Power good indicator. The PG pin is an open drain; it requires a pull-up resistor to the power source. If the output voltage (V_{OUT}) is between 90% and 108% of the nominal voltage, PG is pulled up to the power source. If V_{OUT} exceeds 116% or drops below 84% of the nominal voltage, PG goes low.
4	FB	Feedback point. The FB pin is the negative input of the error amplifier (EA). To set the regulation voltage, connect FB to the tap of an external resistor divider between the output and GND. The PG and under-voltage lockout (UVLO) circuits use FB to monitor V_{OUT} .
5	FREQ	Configurable switching frequency (f_{sw}). To set f_{sw} , connect a resistor to GND.
6	VCC	Internal bias supply. The VCC pin supplies power to the internal control circuit and gate drivers. Place a 1 μ F or greater decoupling capacitor close to GND.
7	GND	IC ground. Connect the large copper areas of GND to the negative terminals of the input and output capacitors.
8	VIN	Input supply. The VIN pin supplies power to the converter. To reduce switching spikes, place a decoupling capacitor close to GND, as close to the IC as possible.
9, 10	NC	No connection. To improve thermal and EMI performance, connect the NC pins to GND.
11	CCM/ SYNCO	Mode selection/synchronous output. To force the converter into continuous conduction mode (CCM), connect the CCM/SYNCO pin to GND via a 10k Ω to 300k Ω resistor. Float this pin to force the converter into advanced asynchronous modulation (AAM) mode under light-load conditions. CCM/SYNCO is also a synchronization output pin that can output a 180° out-of-phase clock to other devices.
12	EN	Enable. Drive the EN pin above 1.45V to turn the converter on; float or drive EN below 1.12V to turn the converter off.

ABSOLUTE MAXIMUM RATINGS ⁽¹⁾

V_{IN}	65V
V_{SW}	-0.3V to $V_{IN} + 0.3V$
V_{BST}	$V_{SW} + 6V$
All other pins	-0.3V to +6V
Continuous power dissipation ($T_A = 25^\circ C$) ⁽²⁾	
QFN-12 (2.5mmx3mm)	2.08W
Junction temperature	150°C
Lead temperature	260°C
Storage temperature	-65°C to +150°C

ESD Ratings

Human body model (HBM)	$\pm 2kV$
Charged device model (CDM)	$\pm 750V$

Recommended Operating Conditions

Continuous supply voltage (V_{IN}).....	4.5V to 60V
Output voltage (V_{OUT})	1V to 90% of V_{IN}
Load current range	0A to 2.5A
Operating junction temp (T_J)	-40°C to +150°C

Thermal Resistance	θ_{JA}	θ_{JC}
QFN-12 (2.5mmx3mm)		
JESD51-7 ⁽³⁾	60.....	13....°C/W
EVQ4573-QB-00A ⁽⁴⁾	45.....	11....°C/W

Notes:

- 1) Absolute maximum ratings are rated under room temperature, unless otherwise noted. Exceeding these ratings may damage the device.
- 2) The maximum allowable power dissipation is a function of the maximum junction temperature T_J (MAX), the junction-to-ambient thermal resistance θ_{JA} , and the ambient temperature T_A . The maximum allowable continuous power dissipation at any ambient temperature is calculated by P_D (MAX) = $(T_J$ (MAX) - T_A) / θ_{JA} . Exceeding the maximum allowable power dissipation can cause excessive die temperature, and the module may go into thermal shutdown. Internal thermal shutdown circuitry protects the device from permanent damage.
- 3) Measured on JESD51-7, 4-layer PCB. The values given in this table are only valid for comparison with other packages and cannot be used for design purposes. These values were calculated in accordance with JESD51-7, and simulated on a specified JEDEC board. They do not represent the performance obtained in an actual application.
- 4) Measured on MPS standard evaluation board (8.9cmx8.9cm), thick 2oz copper, 4-layer PCB.

ELECTRICAL CHARACTERISTICS

$V_{IN} = 24V$, $V_{EN} = 2V$, $T_J = -40^{\circ}C$ to $+125^{\circ}C$, typical values are at $T_J = 25^{\circ}C$, unless otherwise noted.

Parameters	Symbol	Condition	Min	Typ	Max	Units
Input Supply and Under-Voltage Lockout (UVLO)						
Quiescent supply current	I_Q	No load, $V_{FB} = 0.85V$, AAM		40	65	μA
Shutdown supply current	I_{SD}	$V_{EN} = 0V$		2	5	μA
V_{IN} UVLO rising threshold	$V_{IN_UV_RISE}$		3.8	4	4.2	V
V_{IN} UVLO falling threshold	$V_{IN_UV_FALL}$		3.3	3.5	3.7	V
V_{IN} UVLO threshold hysteresis	$V_{IN_UV_HYS}$			500		mV
Output and Regulation						
Feedback (FB) reference voltage	V_{REF}	$T_J = 25^{\circ}C$	0.792	0.8	0.808	V
		$T_J = -40^{\circ}C$ to $+125^{\circ}C$	0.784		0.816	V
FB input current	I_{FB}	$V_{FB} = 0.85V$		10	50	nA
Switches and Frequency						
HS-FET on resistance	$R_{DS(ON)_HS}$	$V_{BST} - V_{SW} = 5V$, $T_J = 25^{\circ}C$	150	250	350	m Ω
		$V_{BST} - V_{SW} = 5V$, $T_J = -40^{\circ}C$ to $+125^{\circ}C$	100		500	
LS-FET on resistance	$R_{DS(ON)_LS}$	$T_J = 25^{\circ}C$	30	45	60	m Ω
		$T_J = -40^{\circ}C$ to $+125^{\circ}C$	20		90	
SW leakage current	I_{SW_LKG}	$V_{EN} = 0V$, $V_{SW} = 0V$ or $60V$		0.1	30	μA
Switching frequency	f_{SW}	$R_{FREQ} = 76.8k\Omega$	300	400	500	kHz
		$R_{FREQ} = 28k\Omega$	750	1000	1250	
		$R_{FREQ} = 12.1k\Omega$	1800	2200	2700	
Minimum on time ⁽⁵⁾	t_{ON_MIN}			90		ns
Minimum off time ⁽⁵⁾	t_{OFF_MIN}			100		ns
Power Good (PG)						
PG current sink	V_{PG_SINK}	Sink 4mA			300	mV
PG delay time	t_{PG_DELAY}	Rising edge		70		μs
		Falling edge		25		
PG leakage current	I_{PG_LKG}			10	1000	nA
PG rising threshold (V_{FB} / V_{REF})	PG_{RISING}	V_{FB} rising		90		%
		V_{FB} falling		108		
PG falling threshold (V_{FB} / V_{REF})	$PG_{FALLING}$	V_{FB} falling		84		%
		V_{FB} rising		116		
Enable (EN)						
EN rising threshold	V_{EN_RISING}		1.38	1.45	1.52	V
EN falling threshold	$V_{EN_FALLING}$		1.05	1.12	1.19	V
EN threshold hysteresis	V_{EN_HYS}			330		mV
EN input current	I_{EN}	$V_{EN} = 2V$		0.7		μA
EN turn-off delay	t_{EN_DELAY}		5			μs
Bootstrap (BST)						
(BST - SW) UVLO				1.4	2.5	V
(BST - SW) UVLO hysteresis				60		mV
Soft Start (SS) and VCC						
Soft-start time	t_{SS}			0.45		ms
VCC regulator	V_{CC}	$I_{CC} = 0A$	4.6	4.9	5.2	V

ELECTRICAL CHARACTERISTICS (continued)
 $V_{IN} = 24V$, $V_{EN} = 2V$, $T_J = -40^{\circ}C$ to $+125^{\circ}C$, typical values are at $T_J = 25^{\circ}C$, unless otherwise noted.

Parameters	Symbol	Condition	Min	Typ	Max	Units
Protections						
Peak current limit threshold	I_{PK_LIMIT}	20% duty cycle	3	3.9	5.4	A
Valley current limit threshold	I_{VAL_LIMIT}		3			A
Zero-current detection (ZCD) threshold	I_{ZCD}	AAM	-100	140	+300	mA
Negative current limit threshold	I_{NEG_LIMIT}	FCCM	-2	-1.3	-0.8	A
Thermal shutdown ⁽⁵⁾	T_{SD}	Rising temperature		170		$^{\circ}C$
Thermal shutdown hysteresis ⁽⁵⁾	T_{SD_HYS}			25		$^{\circ}C$

Note:

5) Derived from bench characterization. Not tested in production.

TYPICAL CHARACTERISTICS

$V_{IN} = 24V$, $T_J = -40^{\circ}C$ to $+125^{\circ}C$, unless otherwise noted.

Quiescent Current vs. Temperature

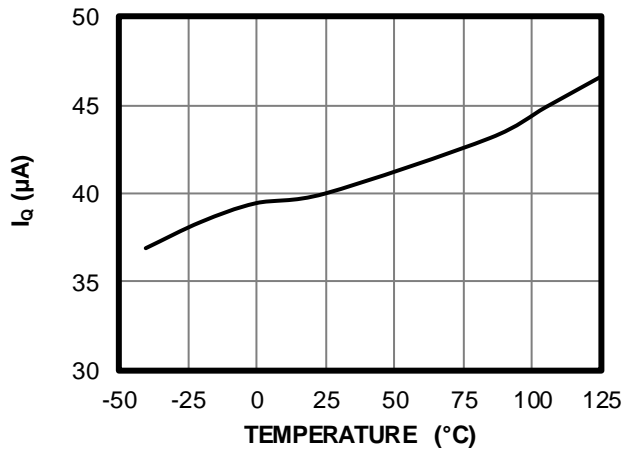

Shutdown Current vs. Temperature

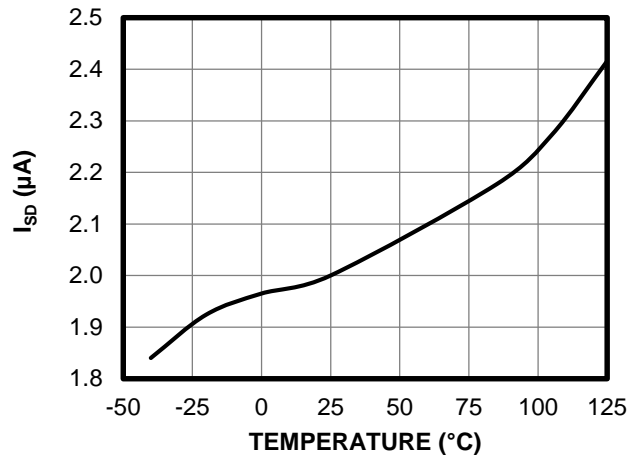

V_{IN} UVLO Threshold vs. Temperature

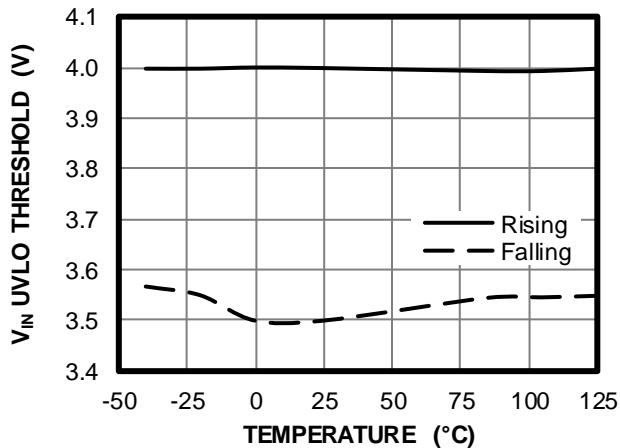

Feedback Reference vs. Temperature

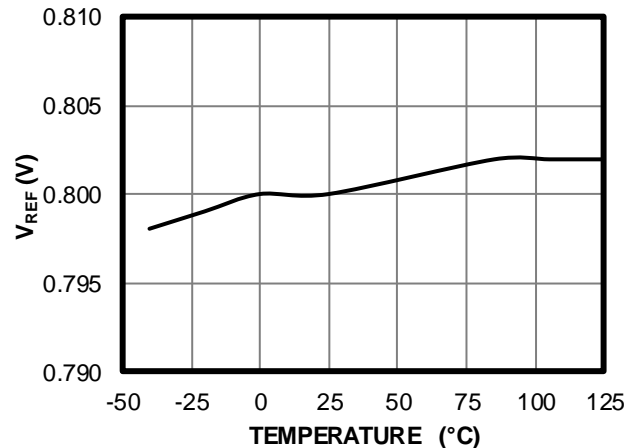

V_{CC} vs. Temperature

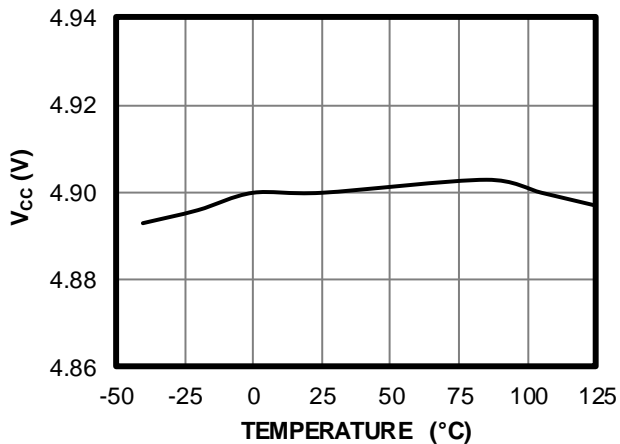

EN Threshold vs. Temperature

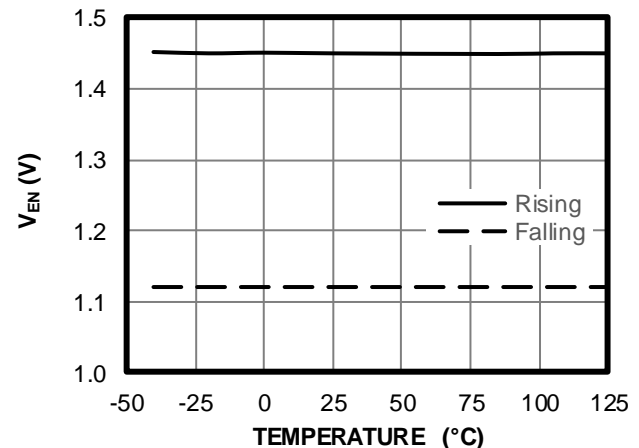

TYPICAL CHARACTERISTICS (continued)

$V_{IN} = 24V$, $T_J = -40^{\circ}C$ to $+125^{\circ}C$, unless otherwise noted.

ZCD Threshold vs. Temperature

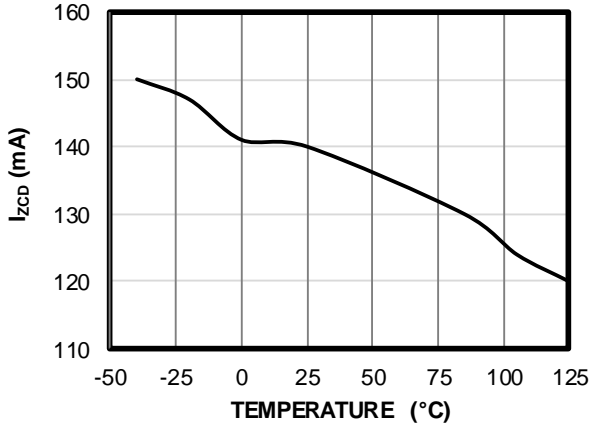

Peak Current Limit vs. Temperature

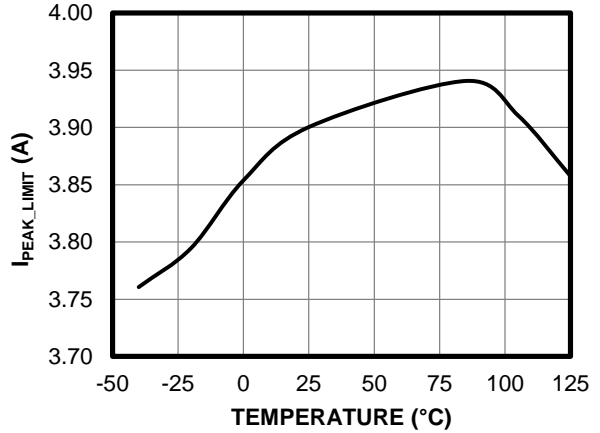

Negative Current Limit vs. Temperature

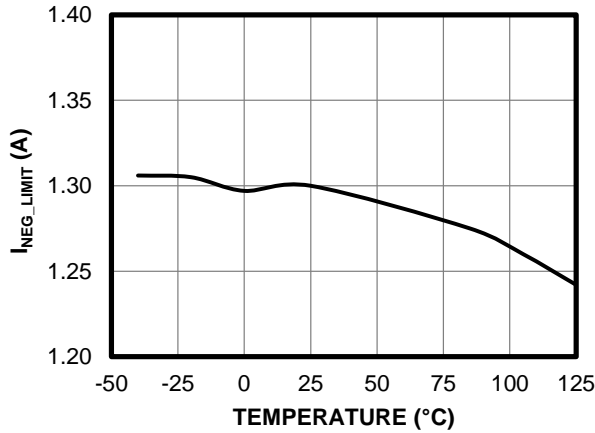

HS-FET On Resistance vs. Temperature

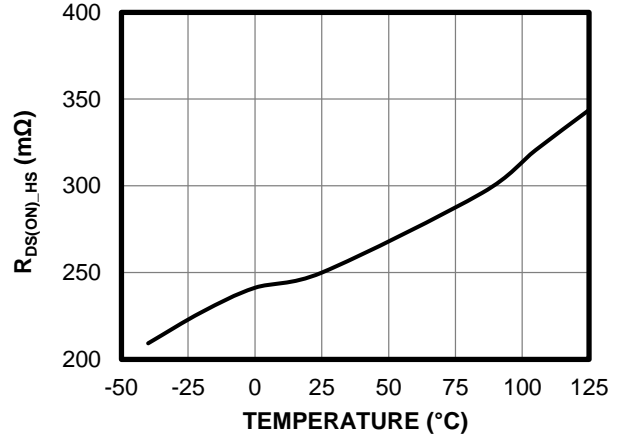

LS-FET On Resistance vs. Temperature

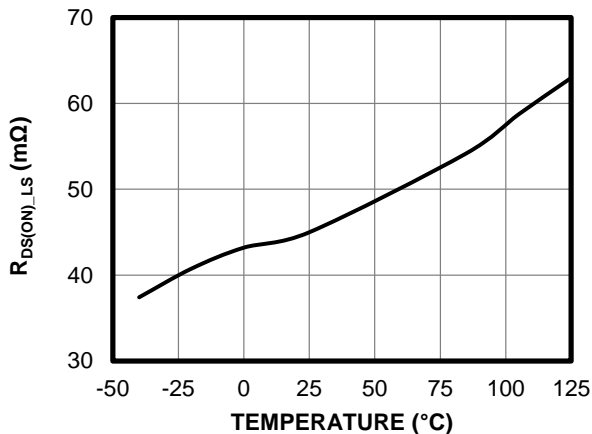

PG Rising Threshold vs. Temperature

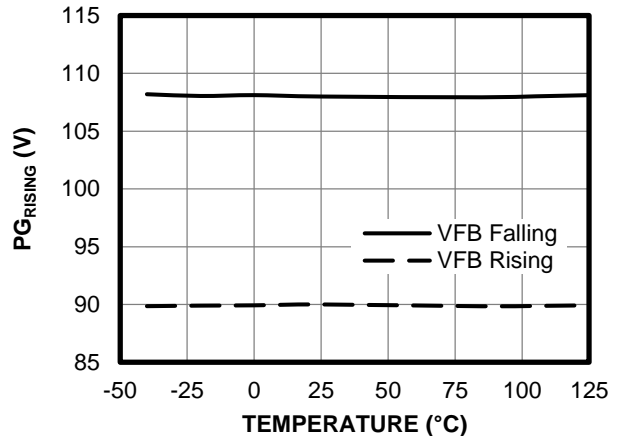

TYPICAL CHARACTERISTICS (continued)

$V_{IN} = 24V$, $T_J = -40^{\circ}C$ to $+125^{\circ}C$, unless otherwise noted.

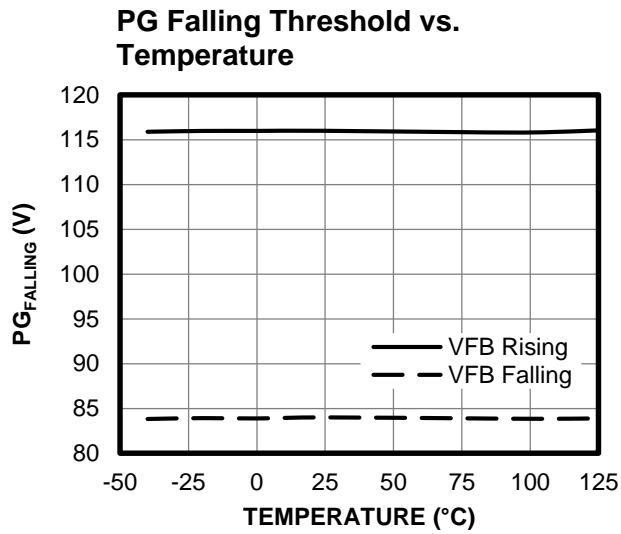

TYPICAL PERFORMANCE CHARACTERISTICS

$V_{IN} = 24V$, $V_{OUT} = 5V$, $L = 15\mu H$, $f_{sw} = 400kHz$, $T_A = 25^\circ C$, unless otherwise noted.

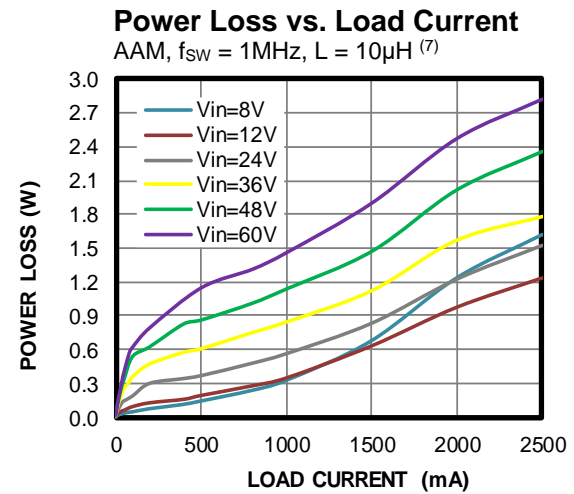
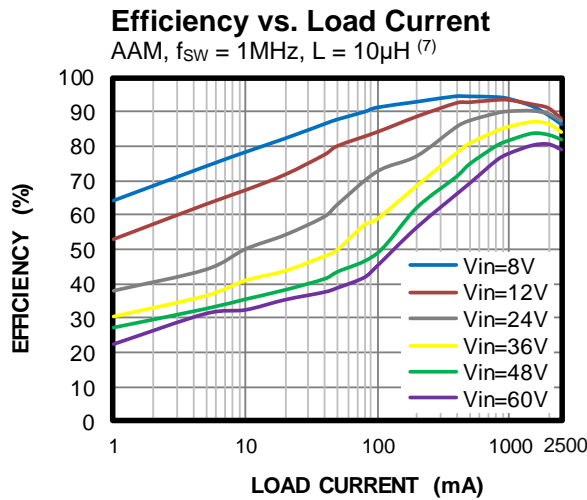
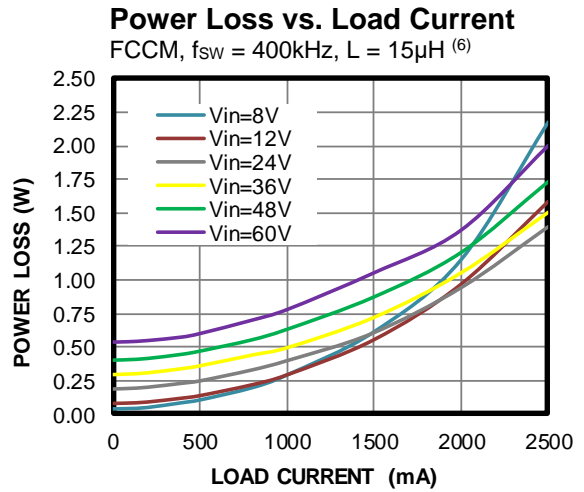
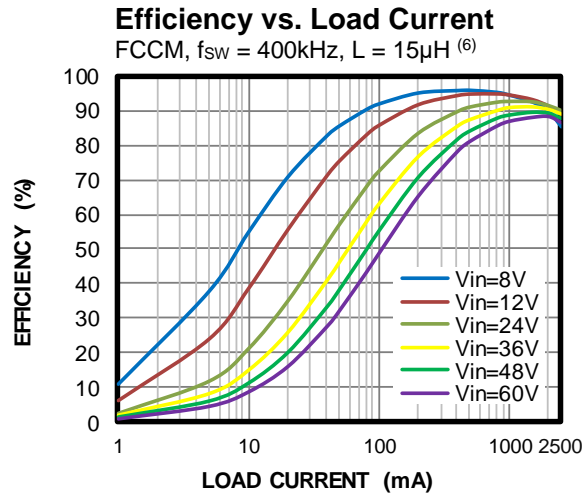
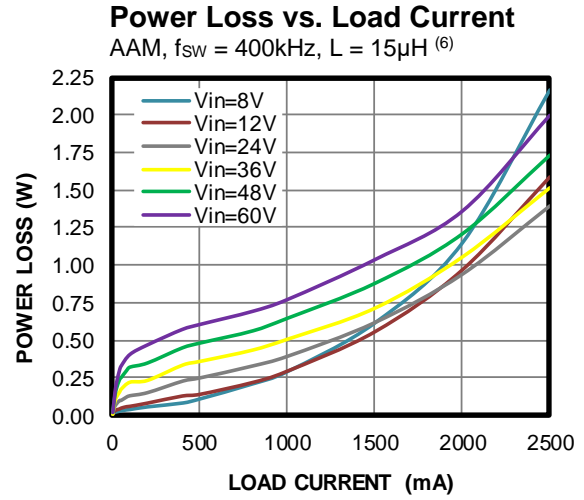
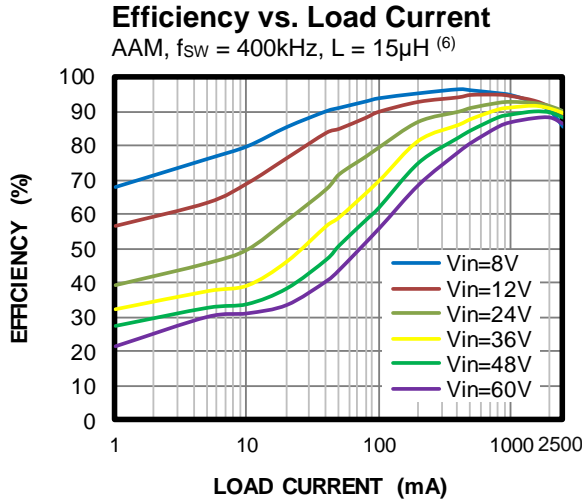

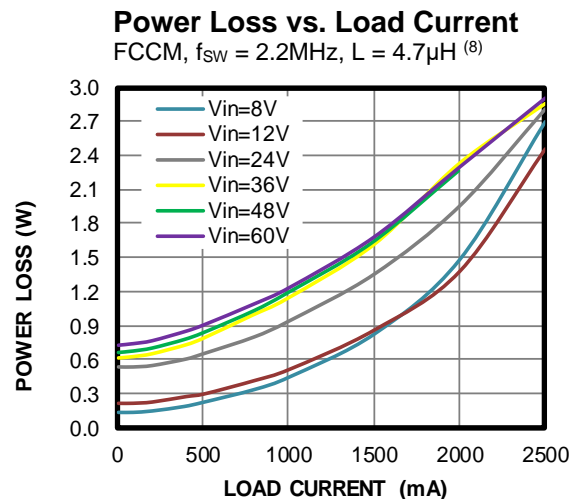
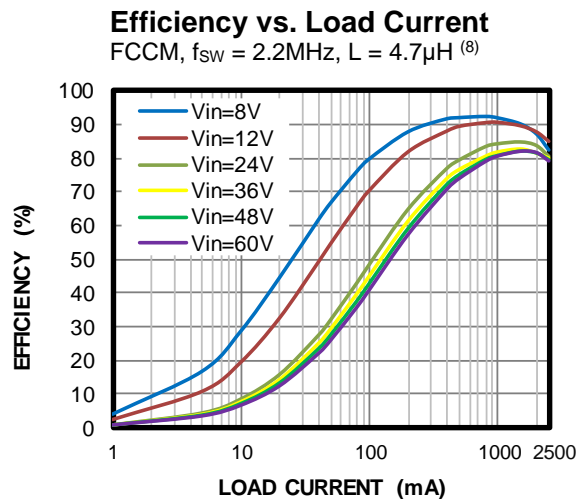
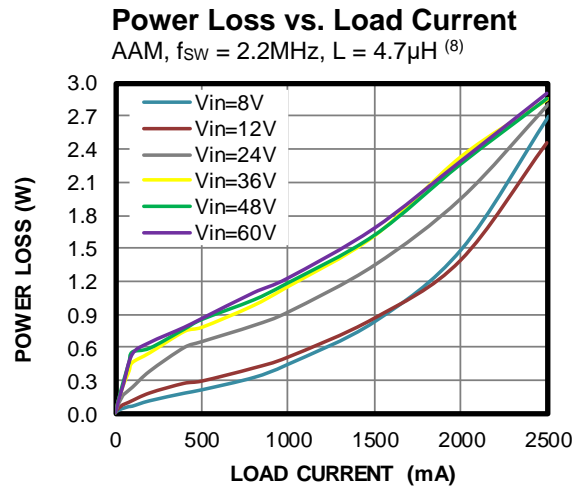
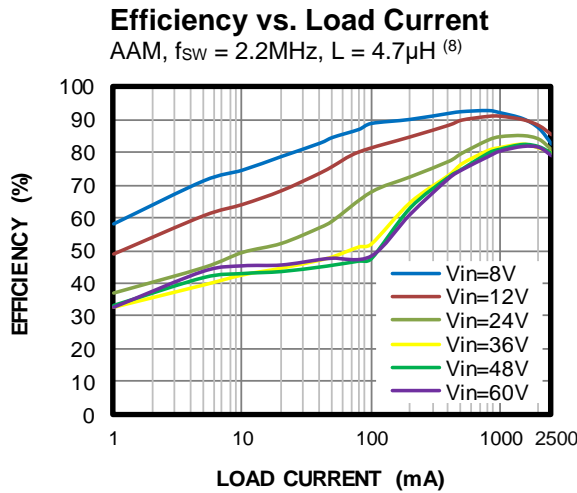
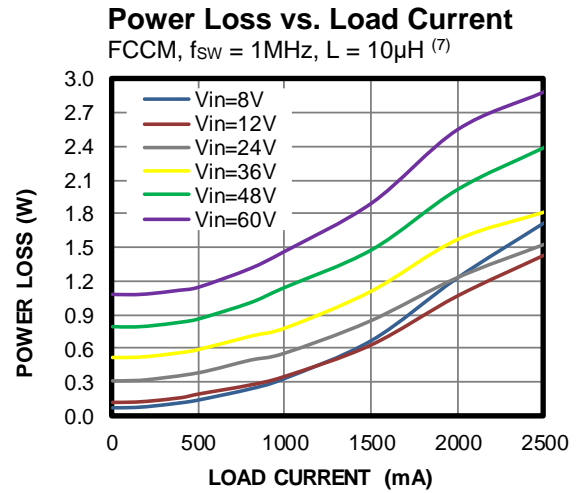
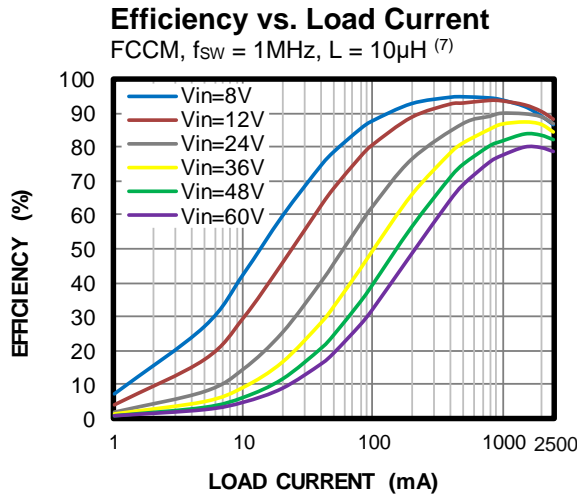
TYPICAL PERFORMANCE CHARACTERISTICS (continued)
 $V_{IN} = 24V$, $V_{OUT} = 5V$, $L = 15\mu H$, $f_{SW} = 400kHz$, $T_A = 25^\circ C$, unless otherwise noted.

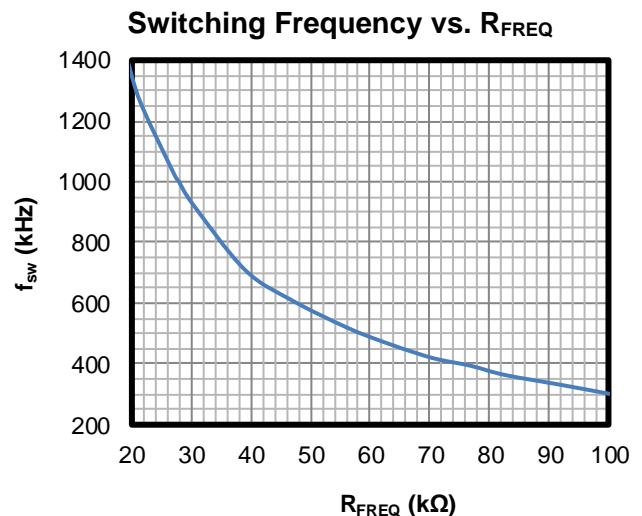
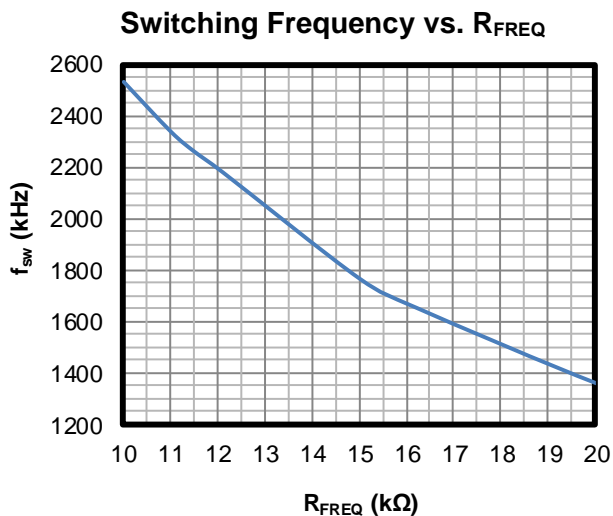
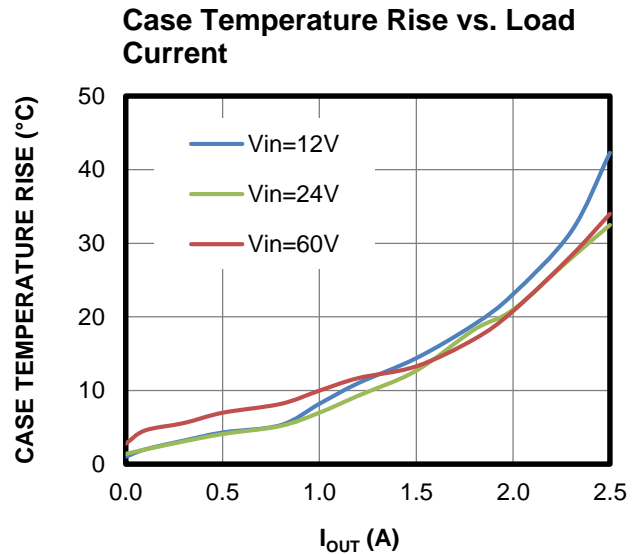
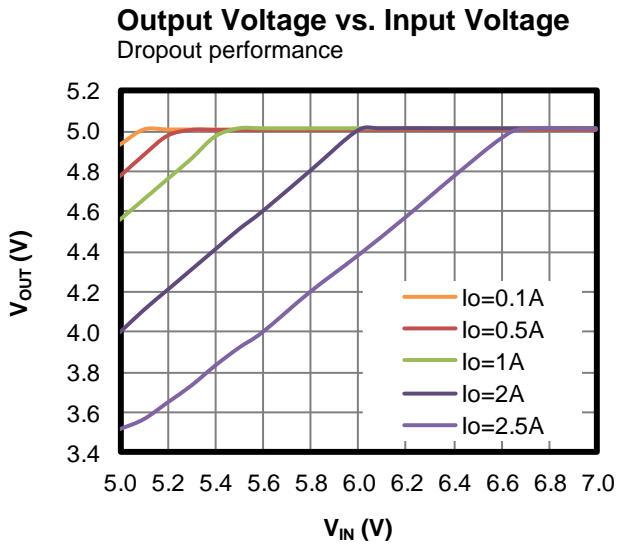
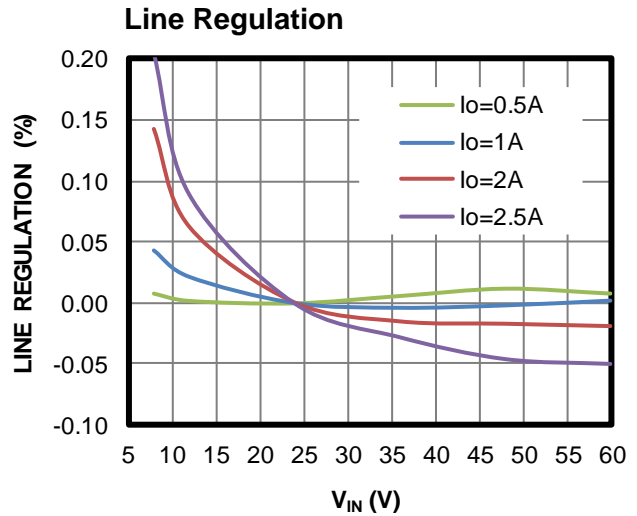
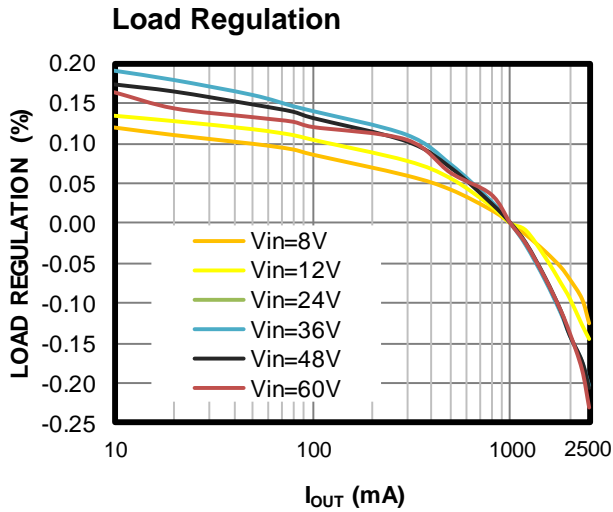
TYPICAL PERFORMANCE CHARACTERISTICS (continued)
 $V_{IN} = 24V$, $V_{OUT} = 5V$, $L = 15\mu H$, $f_{SW} = 400kHz$, AAM, $T_A = 25^\circ C$, unless otherwise noted.

TYPICAL PERFORMANCE CHARACTERISTICS (continued)

$V_{IN} = 24V$, $V_{OUT} = 5V$, $L = 15\mu H$, $f_{SW} = 400kHz$, AAM, $T_A = 25^\circ C$, unless otherwise noted.

Switching Frequency vs. Input Voltage

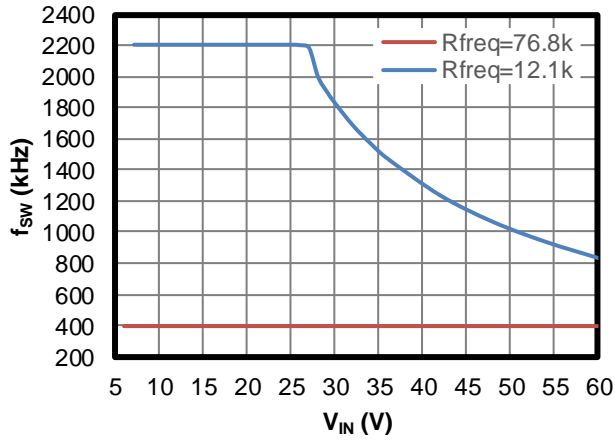

Notes:

- 6) Inductor PN: XAL6060-153MEB/C; DCR = 43.75m Ω .
- 7) Inductor PN: XAL6060-103MEB/C; DCR = 29.82m Ω .
- 8) Inductor PN: XAL5030-472MEB/C; DCR=36.00m Ω .

TYPICAL PERFORMANCE CHARACTERISTICS *(continued)*

$V_{IN} = 12V$, $V_{OUT} = 5V$, $I_{OUT} = 2.5A$, $L = 10\mu H$, $f_{SW} = 400kHz$, AAM, $T_A = 25^\circ C$, unless otherwise noted. ⁽⁹⁾

CISPR25 Class 5 Peak Conducted Emissions
150kHz to 108MHz

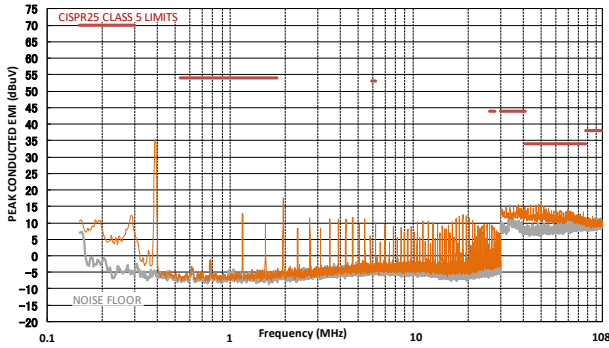

CISPR25 Class 5 Average Conducted Emissions
150kHz to 108MHz

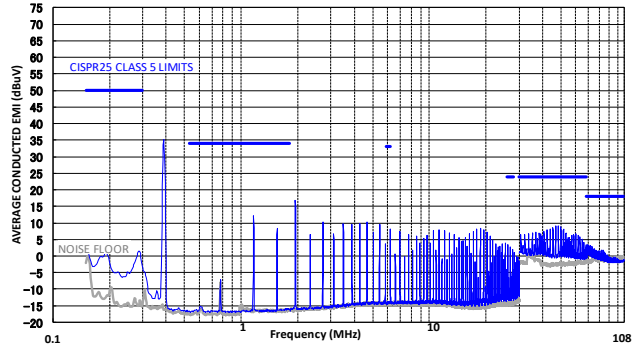

CISPR25 Class 5 Peak Radiated Emissions
150kHz to 30MHz

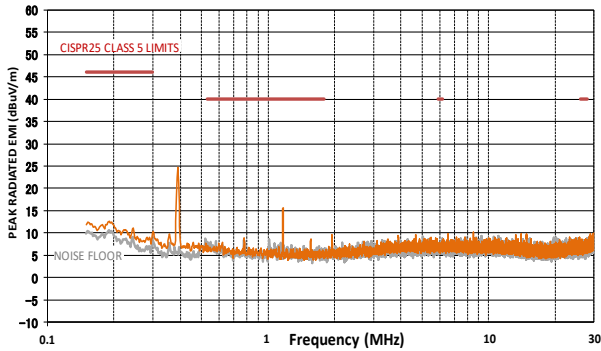

CISPR25 Class 5 Average Radiated Emissions
150kHz to 30MHz

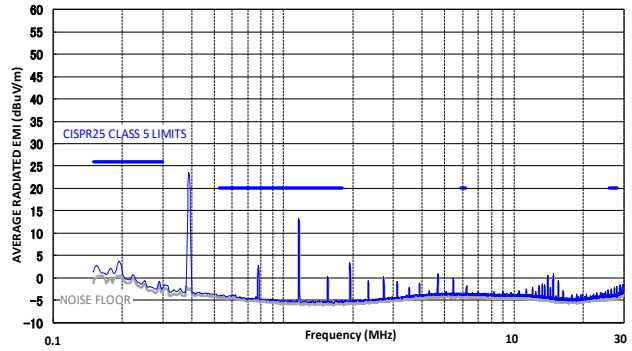

CISPR25 Class 5 Peak Radiated Emissions
Horizontal, 30MHz to 200MHz

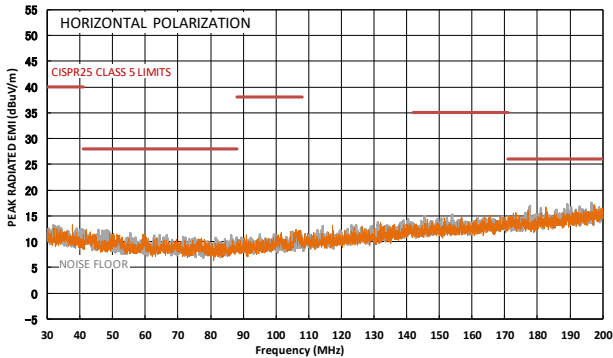

CISPR25 Class 5 Average Radiated Emissions
Horizontal, 30MHz to 200MHz

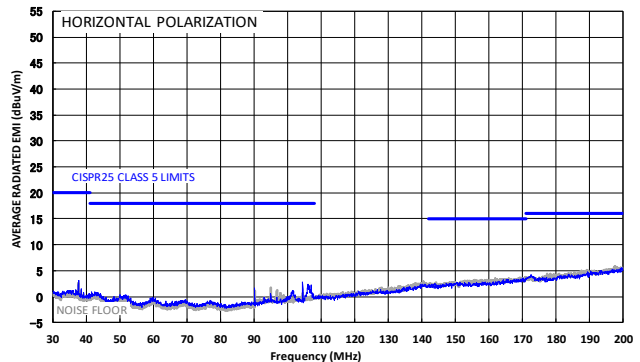

TYPICAL PERFORMANCE CHARACTERISTICS (continued)

$V_{IN} = 12V$, $V_{OUT} = 5V$, $I_{OUT} = 2.5A$, $L = 10\mu H$, $f_{SW} = 400kHz$, AAM, $T_A = 25^\circ C$, unless otherwise noted. (9)

CISPR25 Class 5 Peak Radiated Emissions

Vertical, 30MHz to 200MHz

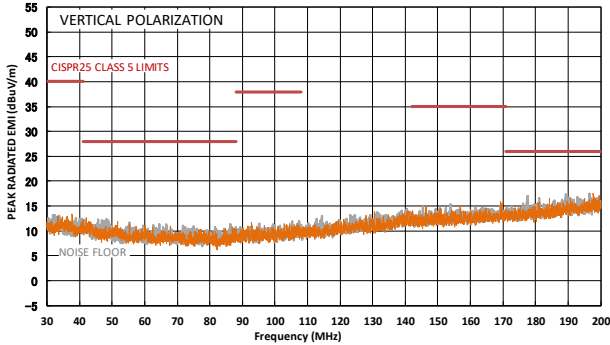

CISPR25 Class 5 Average Radiated Emissions

Vertical, 30MHz to 200MHz

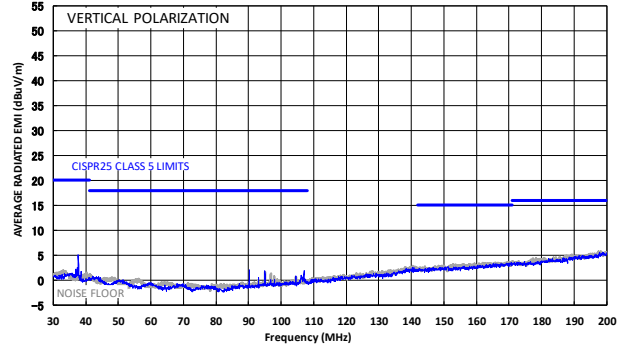

CISPR25 Class 5 Peak Radiated Emissions

Horizontal, 200MHz to 1GHz

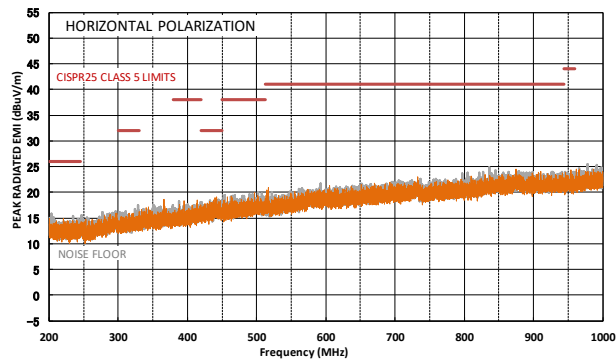

CISPR25 Class 5 Average Radiated Emissions

Horizontal, 200MHz to 1GHz

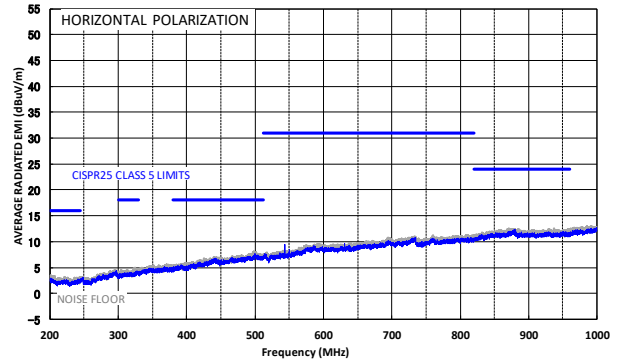

CISPR25 Class 5 Peak Radiated Emissions

Vertical, 200MHz to 1GHz

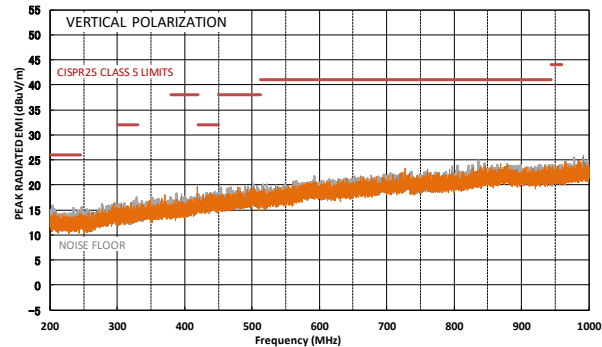

CISPR25 Class 5 Average Radiated Emissions

Vertical, 200MHz to 1GHz

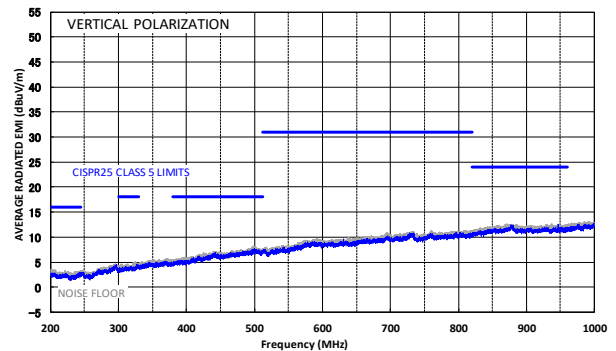

Note:

9) EMC test results are based on the typical application circuit with an EMI filter (see Figure 9 on page 31), and are tested on the EVQ4573-QB-00A. The inductor used for EMI testing is XAL4040-103MEB.

TYPICAL PERFORMANCE CHARACTERISTICS (continued)

$V_{IN} = 24V$, $V_{OUT} = 5V$, $L = 15\mu H$, $f_{sw} = 400kHz$, $T_A = 25^\circ C$, unless otherwise noted.

Start-Up through VIN

$I_{OUT} = 0A$, AAM

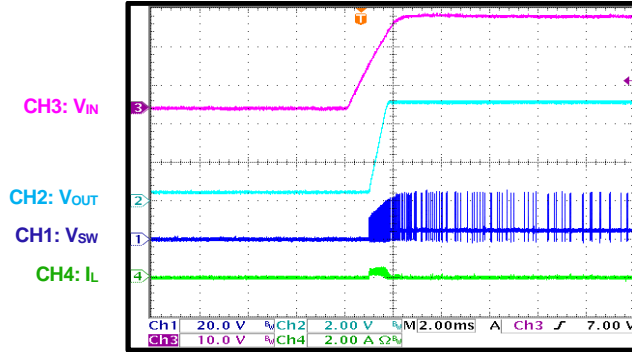

Start-Up through VIN

$I_{OUT} = 0A$, FCCM

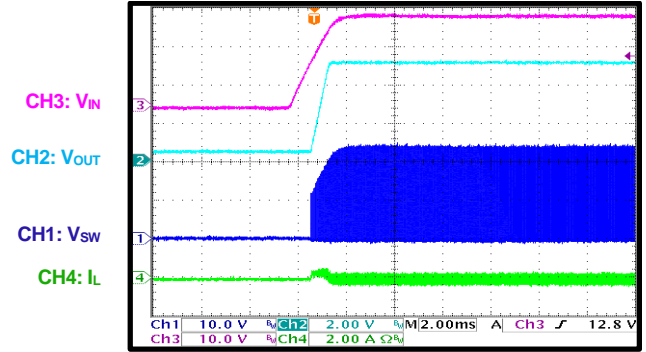

Start-Up through VIN

$I_{OUT} = 2.5A$

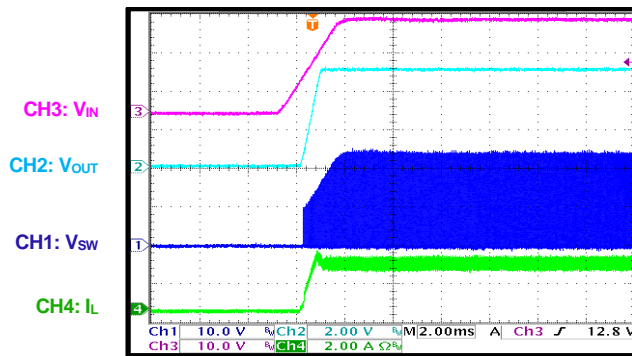

Shutdown through VIN

$I_{OUT} = 0A$, AAM

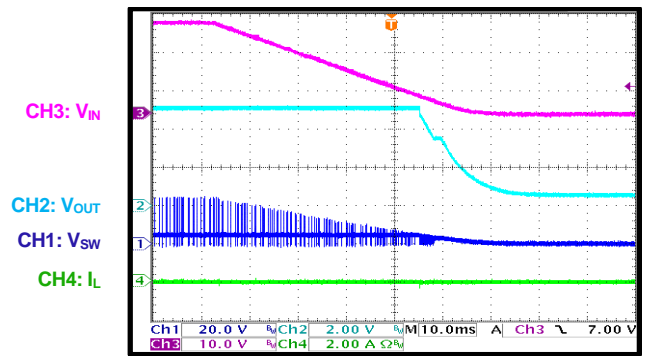

Shutdown through VIN

$I_{OUT} = 0A$, FCCM

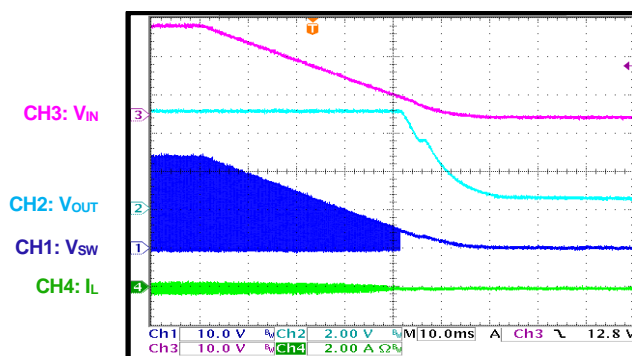

Shutdown through VIN

$I_{OUT} = 2.5A$

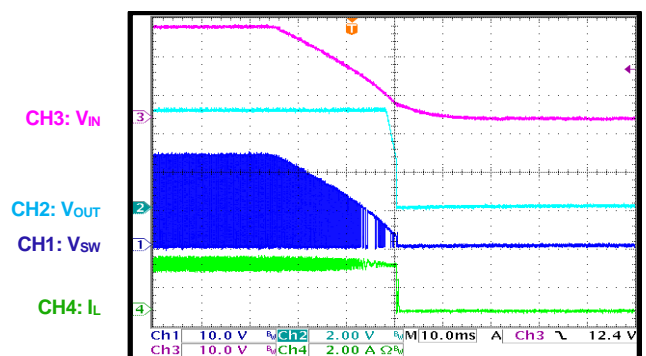

TYPICAL PERFORMANCE CHARACTERISTICS (continued)
 $V_{IN} = 24V$, $V_{OUT} = 5V$, $L = 15\mu H$, $f_{sw} = 400kHz$, $T_A = 25^\circ C$, unless otherwise noted.

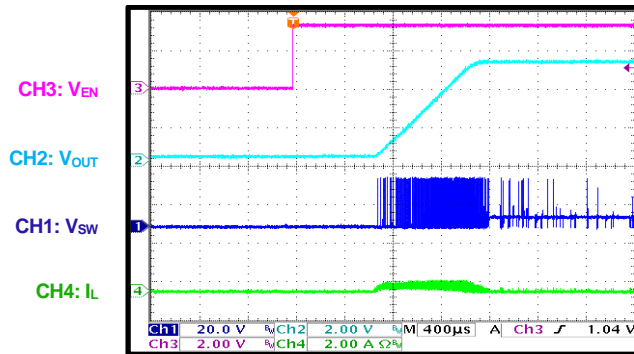
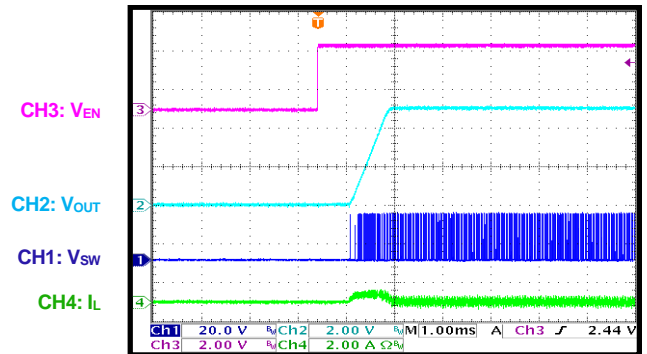
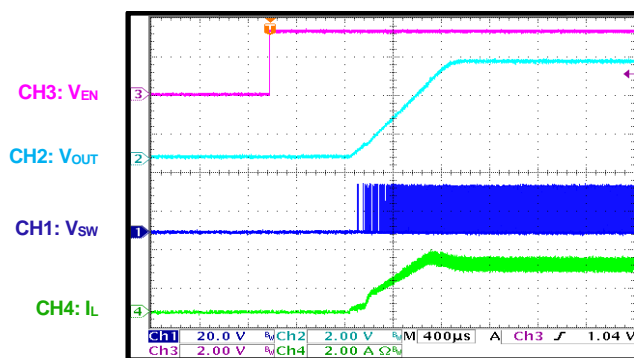
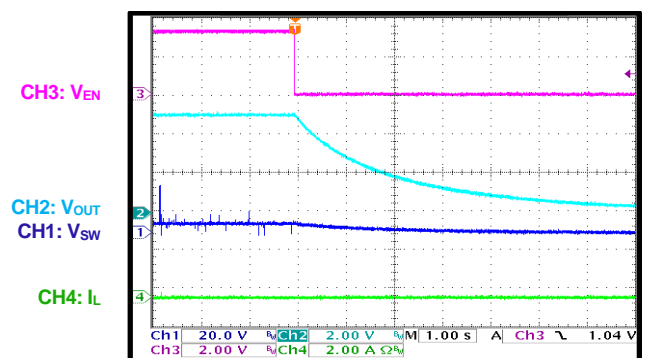
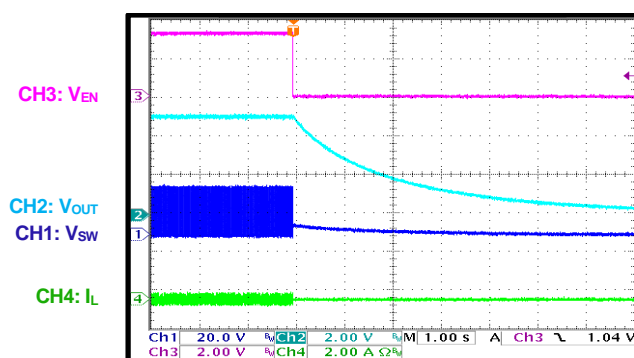
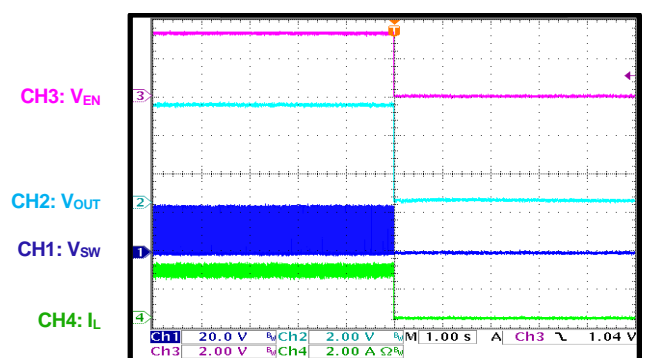
Start-Up through EN
 $I_{OUT} = 0A$, AAM

Start-Up through EN
 $I_{OUT} = 0A$, FCCM

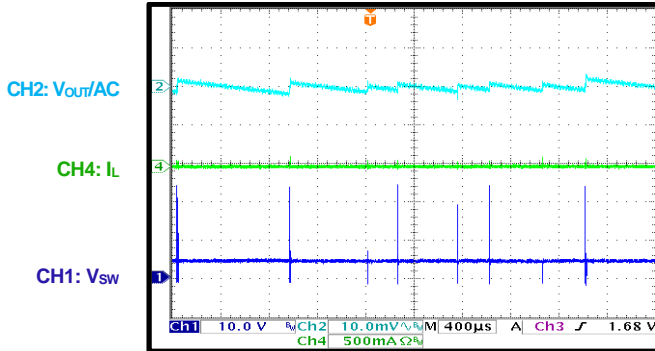
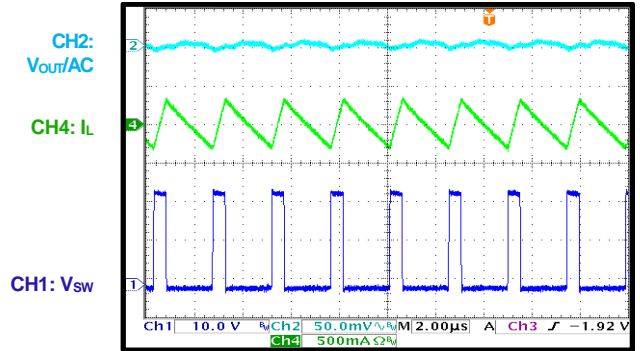
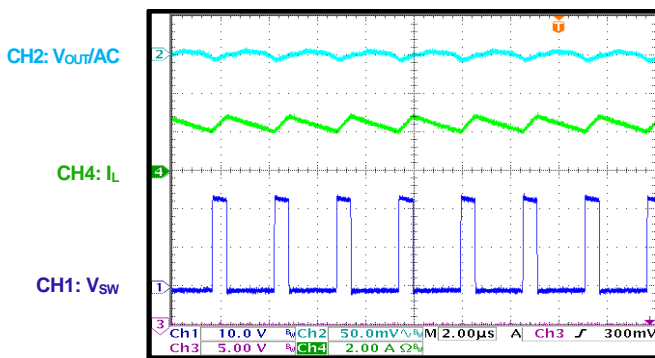
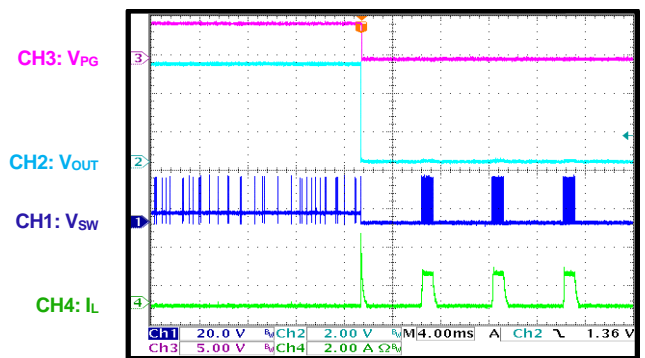
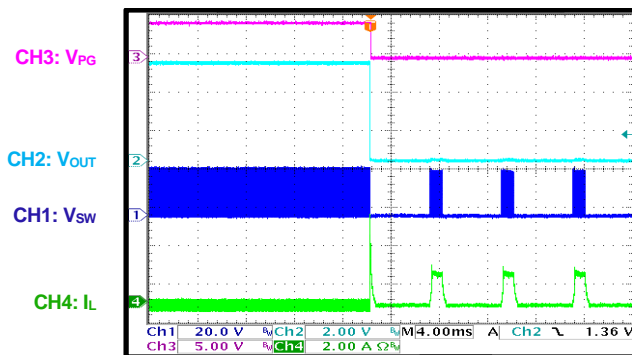
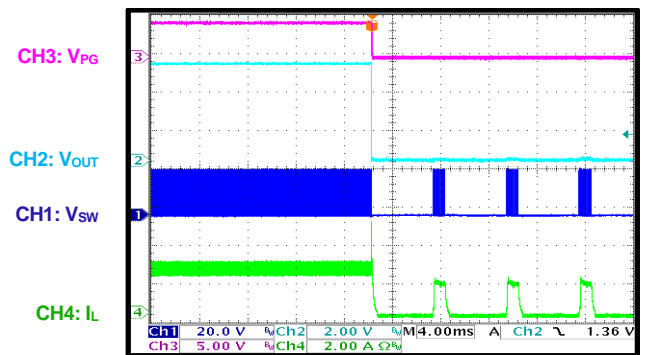
Start-Up through EN
 $I_{OUT} = 2.5A$

Shutdown through EN
 $I_{OUT} = 0A$, AAM

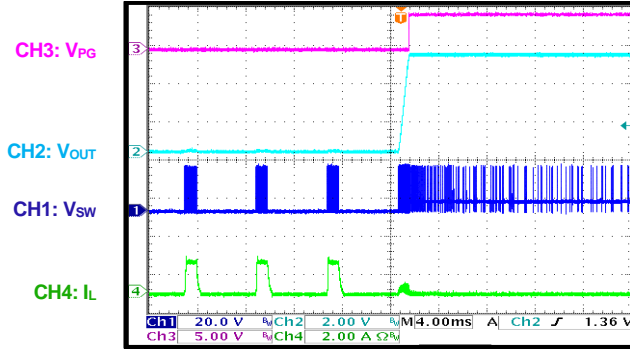
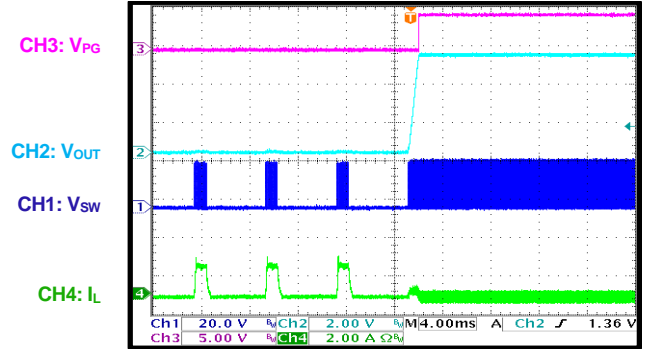
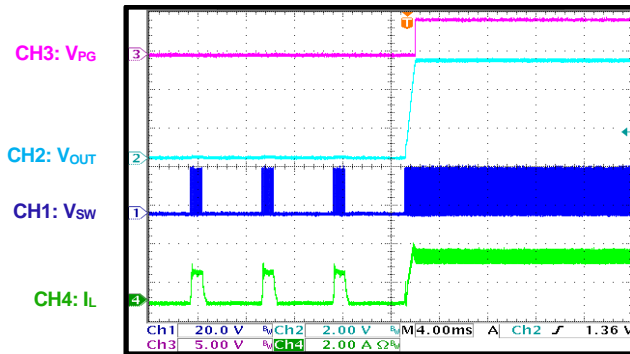
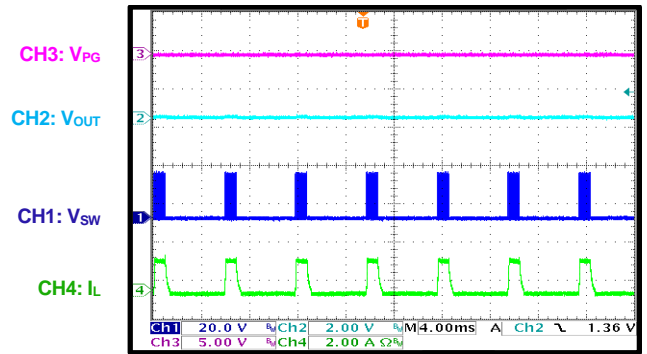
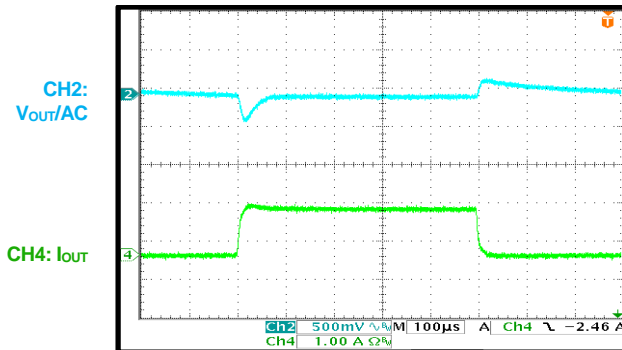
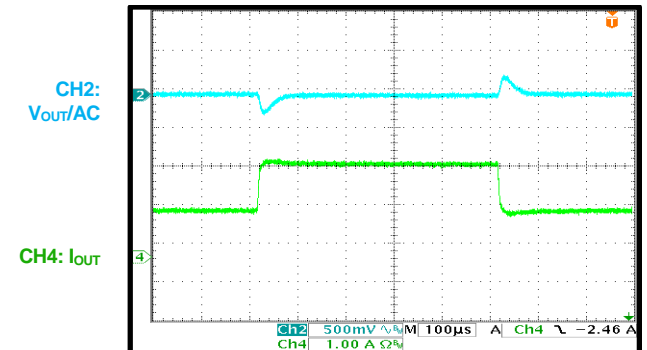
Shutdown through EN
 $I_{OUT} = 0A$, FCCM

Shutdown through EN
 $I_{OUT} = 2.5A$

TYPICAL PERFORMANCE CHARACTERISTICS (continued)
 $V_{IN} = 24V$, $V_{OUT} = 5V$, $L = 15\mu H$, $f_{sw} = 400kHz$, $T_A = 25^\circ C$, unless otherwise noted.

Output Ripple
 $I_{OUT} = 0A$, AAM

Output Ripple
 $I_{OUT} = 0A$, FCCM

Output Ripple
 $I_{OUT} = 2.5A$

SCP Entry
 $I_{OUT} = 0A$, AAM

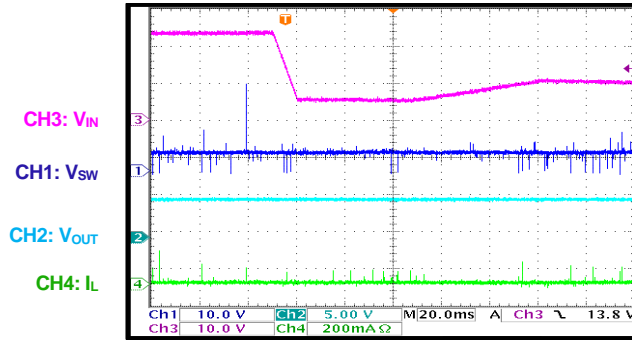
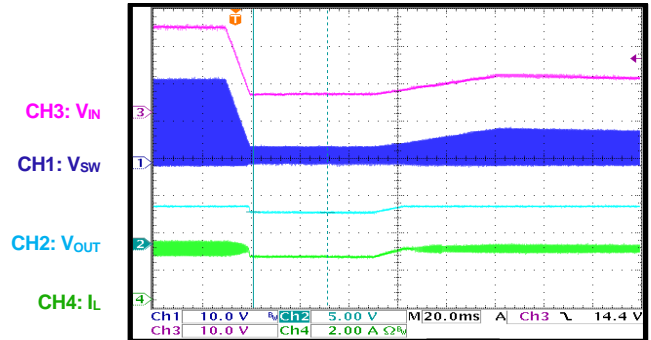
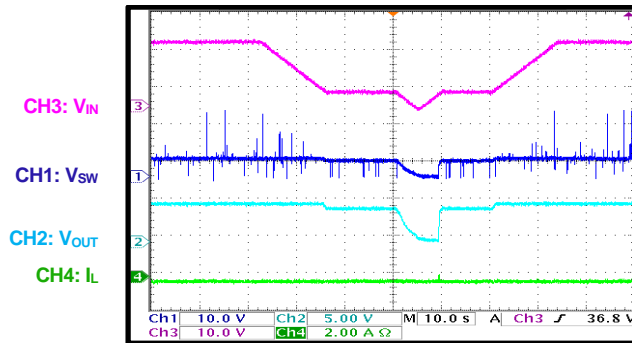
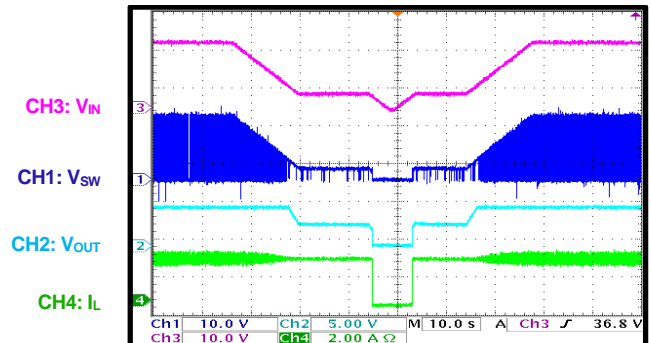
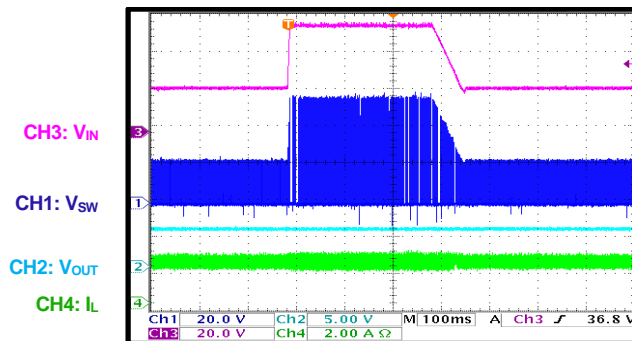
SCP Entry
 $I_{OUT} = 0A$, FCCM

SCP Entry
 $I_{OUT} = 2.5A$

TYPICAL PERFORMANCE CHARACTERISTICS (continued)
 $V_{IN} = 24V$, $V_{OUT} = 5V$, $L = 15\mu H$, $f_{sw} = 400kHz$, $T_A = 25^\circ C$, unless otherwise noted.

SCP Recovery
 $I_{OUT} = 0A$, AAM

SCP Recovery
 $I_{OUT} = 0A$, FCCM

SCP Recovery
 $I_{OUT} = 2.5A$

SCP Steady State

Load Transient
 $I_{OUT} = 0A$ to 1.5A, AAM

Load Transient
 $I_{OUT} = 1A$ to 2.5A, AAM

TYPICAL PERFORMANCE CHARACTERISTICS (continued)
 $V_{IN} = 24V, V_{OUT} = 5V, L = 15\mu H, f_{SW} = 400kHz, T_A = 25^\circ C$, unless otherwise noted.

Cold Crank
 $V_{IN} = 24V$ to 6V to 10V, $I_{OUT} = 0A$

Cold Crank
 $V_{IN} = 24V$ to 6V to 10V, $I_{OUT} = 2.5A$

 V_{IN} Ramps Up and Down
 $V_{IN} = 18V$ to 4.5V to 0V to 4.5V to 18V, $I_{OUT} = 0A$

 V_{IN} Ramps Up and Down
 $V_{IN} = 18V$ to 4.5V to 0V to 4.5V to 18V, $I_{OUT} = 2.5A$

Load Dump
 $V_{IN} = 24V$ to 58V to 24V, $I_{OUT} = 2.5A$

FUNCTIONAL BLOCK DIAGRAM

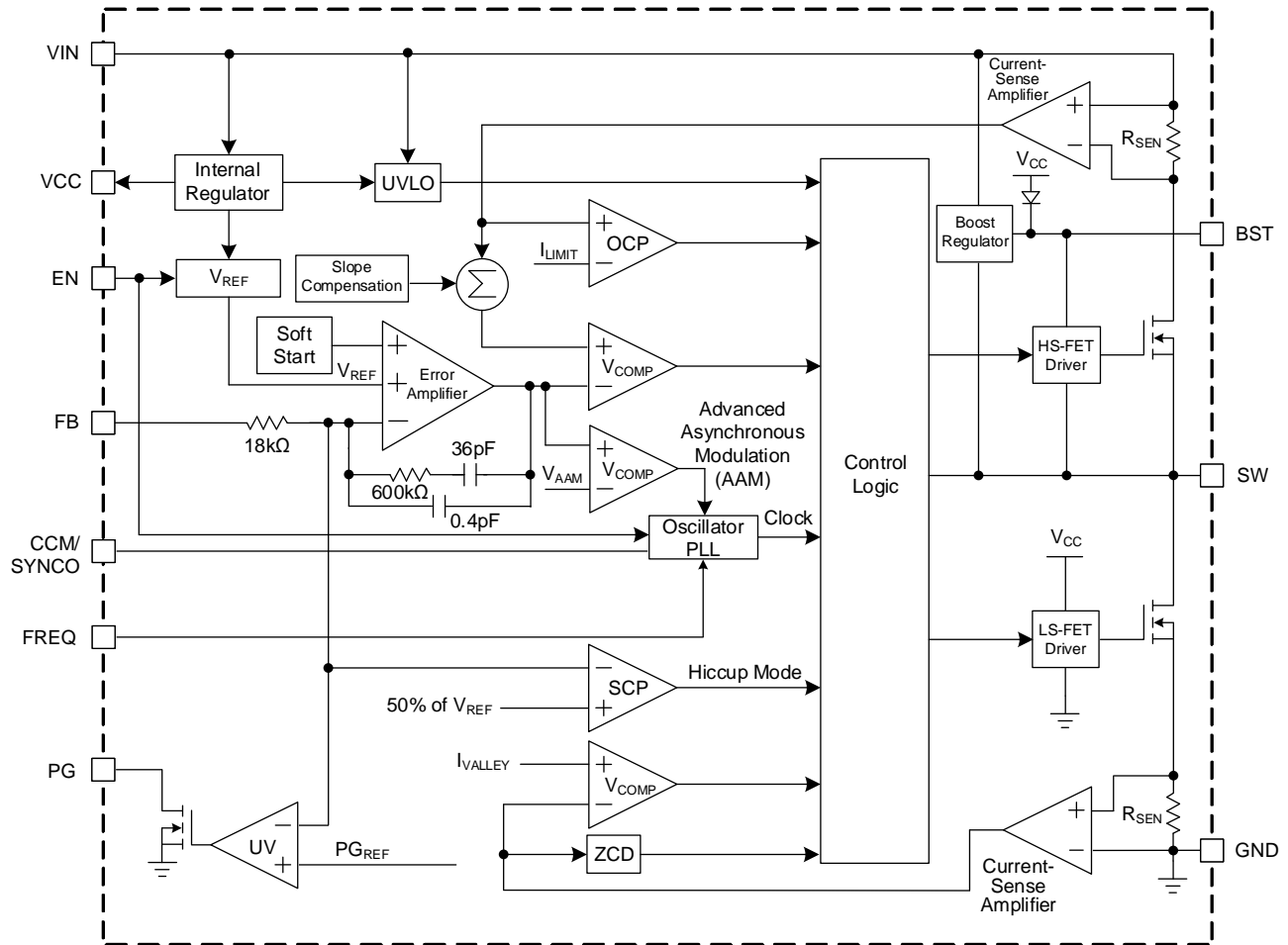

Figure 1: Functional Block Diagram

OPERATION

The MPQ4573 is a fully integrated, synchronous, rectified, step-down, non-isolated switch-mode converter. It can achieve up to 2.5A of continuous output current (I_{OUT}) across a wide 4.5V to 60V input supply range, with excellent load and line regulation across an ambient temperature range of -40°C to $+125^{\circ}\text{C}$.

Pulse-Width Modulation (PWM) Control

The MPQ4573 operates in a fixed-frequency, peak current control mode to regulate the output voltage (V_{OUT}) at moderate to high output currents.

An internal clock initiates the pulse-width modulation (PWM) cycle. At the rising edge of the clock, the high-side MOSFET (HS-FET) turns on and the inductor current (I_L) rises linearly to provide energy to the load. The HS-FET remains on until its current reaches the value set by the COMP voltage (V_{COMP}), which is the output of the internal error amplifier (EA). V_{COMP} is based on the difference between the output feedback voltage (V_{FB}) and internal high-precision reference. V_{COMP} determines the amount of energy that should be transferred to the load. The higher the load current, the higher V_{COMP} will be. Once the HS-FET turns on, it remains on for a minimum of 90ns.

If the HS-FET is off, the low-side MOSFET (LS-FET) turns on and remains on until the clock initiates the next cycle. During this time, I_L flows through the LS-FET. Once the LS-FET is on, it remains on for a minimum of 100ns before the next cycle begins. To avoid shoot-through, a dead time is inserted to prevent the HS-FET and LS-FET from turning on simultaneously.

If the current in the HS-FET does not reach V_{COMP} within one PWM cycle, the HS-FET remains on, saving a shutdown cycle.

Light-Load Operation

The MPQ4573 features configurable forced continuous conduction mode (FCCM) and advanced asynchronous modulation (AAM) mode. FCCM maintains a constant switching frequency (f_{SW}) and small output ripple, but has low efficiency under light-load conditions. AAM mode is set by the CCM/SYNCO pin and achieves high efficiency under light-load

conditions (see Figure 2). To force the device into FCCM, use a 10k Ω to 300k Ω resistor to connect CCM/SYNCO to GND.

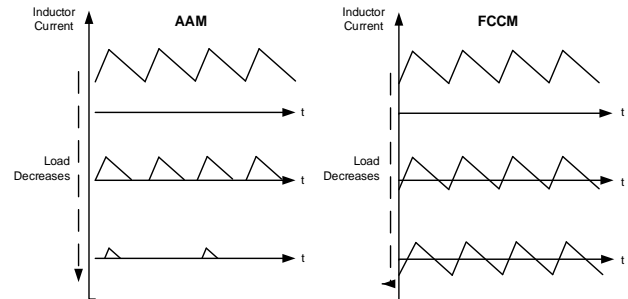

Figure 2: AAM Mode and FCCM under Light-Load Conditions

In FCCM, the converter operates at a fixed frequency across a no-load to full-load range. Under light-load conditions, float CCM/SYNCO to force the device into AAM mode. The device cannot change modes once it is turned on; the desired mode must be selected before start-up.

In AAM mode, f_{SW} scales down according to V_{COMP} . The MPQ4573 enters asynchronous operation as I_L reaches zero. If the load decreases further or there is no load, V_{COMP} drops below the internally set AAM value (V_{AAM}). The MPQ4573 enters sleep mode and consumes a low quiescent current (I_Q) to improve light-load efficiency.

In sleep mode, the internal clock is blocked, causing the MPQ4573 to skip pulses. V_{FB} drops below V_{REF} , and V_{COMP} ramps up until it exceeds V_{AAM1} . Then the internal clock resets and the crossover time is used as a benchmark for the next clock cycle. This control scheme improves efficiency by scaling down the frequency to reduce switching and gate driver losses.

As I_{OUT} increases from light-load, both V_{COMP} and f_{SW} rise. If I_{OUT} exceeds V_{COMP} 's set critical level, the MPQ4573 enters discontinuous conduction mode (DCM) or continuous conduction mode (CCM). CCM has a constant switching frequency.

Enable (EN) Control

The MPQ4573 can be enabled or disabled via a remote EN signal that is referenced to GND. The remote EN control operates with a positive logic, which is compatible with popular logic devices.

Positive logic indicates whether the input voltage (V_{IN}) has exceeded the under-voltage lockout (UVLO) threshold (about 4V). Pull the EN pin above 1.45V to enable the converter; pull EN below 1.12V to disable the converter. To shut down the converter, float EN via an internal resistor from EN to GND (R_{EN}). If enable (EN) control is on, then $R_{EN} = 2.8M\Omega$. If EN control is off, then $R_{EN} = 1.8M\Omega$.

Synchronous Output (SYNCO)

The MPQ4573 has a SYNCO pin for synchronous output. During start-up, SYNCO remains low and outputs a 180° phase-shift clock to the internal oscillator once soft start (SS) is ready. SYNCO's falling edge is a 180° phase shift from the rising edge of the internal oscillator. The synchronous output function allows two devices to operate at the same frequency, but 180° out of phase. This reduces the total input current ripple and allows for the use of a smaller input bypass capacitor.

Internal Regulator

A 4.9V internal regulator powers most of the MPQ4573's internal circuitries. This regulator takes V_{IN} and operates across the full V_{IN} range. If V_{IN} exceeds 4.9V, the regulator's output is in full regulation. A lower V_{IN} results in a lower V_{OUT} . If V_{IN} exceeds its UVLO threshold and EN is high, the regulator turns on. During an EN shutdown, the internal VCC regulator turns off to reduce power dissipation.

Configurable and Foldback Frequency

The MPQ4573's switching frequency (f_{SW}) can be configured via an external frequency resistor (R_{FREQ}). R_{FREQ} should be placed between the FREQ and GND pins, as close to the IC as possible. Choose an appropriate R_{FREQ} value, which can be calculated with Equation (1):

$$R_{FREQ} (M\Omega) = \frac{30}{f_{SW} (kHz)} \quad (1)$$

A bench test may be required to fine-tune the calculated resistance. Due to the HS-FET's limited minimum on time, it is not possible to use a high f_{SW} with a high V_{IN} . The MPQ4573's control loop sets the maximum f_{SW} automatically to match the set frequency. This reduces excessive power loss in the IC. V_{OUT} is regulated

by varying the HS-FET off time. Varying the duration of the off time automatically reduces f_{SW} .

Compliance with the minimum HS-FET on time is guaranteed. This allows the device to operate at the desired f_{SW} for as long as possible. A correction is only made if V_{IN} is high. For more details, see the Switching Frequency vs. Input Voltage curve on page 14, where $R_{FREQ} = 12.1kHz$.

Table 1 shows the relationship between the switching frequency and R_{FREQ} .

Table 1: Switching Frequency vs. R_{FREQ}

R_{FREQ} (k Ω)	f_{SW} (kHz)	R_{FREQ} (k Ω)	f_{SW} (kHz)
100	300	24.3	1150
91.9	330	22	1250
82.5	360	20	1350
76.8	400	18.2	1500
68.1	430	16.2	1650
61.9	475	15	1750
56	520	14	1900
47	600	13	2050
39	700	12.1	2200
34.8	800	11.5	2250
30	940	11	2350
28	1000	10	2500

Internal Soft Start (SS)

To avoid overshoot during start-up, the MPQ4573 has built-in soft start (SS). During SS, V_{OUT} ramps up at a controlled slew rate once EN goes high. If the soft-start voltage (V_{SS}) drops below the internal reference voltage (V_{REF}), V_{SS} overrides V_{REF} as the EA reference. If V_{SS} exceeds V_{REF} , V_{REF} acts as the reference. Once SS is complete, the MPQ4573 enters steady state operation.

The soft-start time (t_{SS}) is set internally to 0.45ms. If V_{OUT} shorts to GND, V_{FB} is pulled low and V_{SS} discharges. Once the short is removed and the MPQ4573 returns to a normal state, the device initiates another SS.

Pre-Biased Start-Up

If V_{FB} exceeds V_{SS} during start-up, the output has a pre-biased voltage and neither the HS-FET or LS-FET turns on until V_{SS} exceeds V_{FB} . This capability is only available when the device is in AAM mode.

Power Good (PG) Indicator

The MPQ4573 has power good (PG) indication.

The PG pin is the open drain of a MOSFET. A resistor (about 100kΩ) is required to connect PG to a voltage source. In the presence of V_{IN} , this MOSFET turns on and PG is pulled down to GND before SS is ready. If V_{OUT} is between 90% and 108% of the nominal voltage after a 70μs delay, PG goes high. If V_{OUT} is above 116% or below 84% of the nominal voltage after a 25μs delay, PG goes low.

Under-Voltage Lockout (UVLO) Protection

The MPQ4573 includes V_{IN} under-voltage lockout (UVLO) protection to ensure reliable output power. If EN control is on, the MPQ4573 starts up once V_{IN} exceeds its UVLO rising threshold. If V_{IN} drops below the UVLO falling threshold, the device shuts down. This prevents the device from operating at an insufficient voltage. V_{IN} UVLO is a non-latch protection.

Over-Current Protection (OCP)

The MPQ4573 has a 3.9A peak current limit threshold. If I_L exceeds the peak current limit, the HS-FET turns off and the LS-FET turns on to discharge the energy. The HS-FET does not turn on again until I_L drops below the valley current limit threshold. Over-current protection (OCP) prevents I_L runaway that can damage the components.

Short-Circuit Protection (SCP)

If a short-circuit condition occurs, the MPQ4573 reaches its peak current limit and V_{OUT} drops until V_{FB} is below 50% of V_{REF} . The device recognizes this as an output dead short, and triggers short-circuit protection (SCP) with hiccup mode to periodically restart the part.

In hiccup mode, the MPQ4573 disables the output power stage and slowly discharges the soft-start capacitor (C_{SS}), then it initiates another SS. If the short-circuit condition remains after SS ends, the device repeats this operation until the short circuit disappears and V_{OUT} returns to its regulation level. This greatly reduces the average short-circuit current, alleviates thermal issues, and protects the regulator.

Negative Current Protection

The MPQ4573 has a -1.3A negative current limit threshold. If I_L drops below the negative current limit, the LS-FET turns off and the HS-FET turns on. This prevents the negative current from

dropping too low and potentially damaging the components.

Thermal Shutdown

To improve thermal protection, the MPQ4573 monitors the IC temperature internally. This prevents the chip from operating at exceedingly high temperatures. If the junction temperature exceeds the thermal shutdown threshold (about 170°C), the device shuts down. Thermal shutdown is a non-latch protection, and has a 25°C hysteresis. Once the junction temperature drops to about 145°C, the device initiates a SS and resumes normal operation.

Floating Driver and Bootstrap (BST) Charging

An external bootstrap (BST) capacitor powers the floating HS-FET driver. There are two methods to charge the BST capacitor (C_{BST}).

The first method is to charge the capacitor via a diode from V_{CC} in the main charging circuit. If the HS-FET is on, the SW voltage (V_{SW}) should be about equal to V_{IN} , but exceed V_{CC} . In this scenario, C_{BST} is not charged. The ideal charging period occurs when the LS-FET is on, and ($V_{CC} - V_{SW}$) is at its maximum. When there is no I_L present, V_{SW} equals V_{OUT} , and V_{CC} can only charge C_{BST} when V_{OUT} is very small.

The second method is to charge the capacitor via the auxiliary charging circuit from V_{IN} . If the difference between the BST voltage (V_{BST}) and V_{SW} drops below the internal 5V BST regulator voltage, a P-channel MOSFET pass transistor (M1) turns on to charge C_{BST} . This charging current is much smaller than the charging current from V_{CC} , but as long as V_{IN} exceeds V_{SW} , C_{BST} can be charged from V_{IN} . This charging method is useful in sleep mode, where on/off switching does not always occur. Figure 3 shows the internal BST charging circuit.

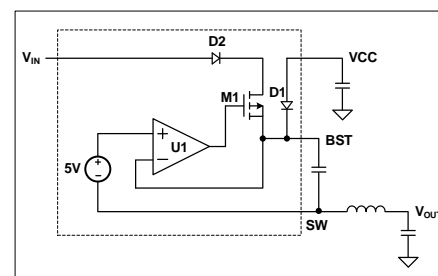

Figure 3: Internal BST Charging Circuit

Low-Dropout (LDO) Mode (BST Refresh)

To improve dropout, the MPQ4573 is designed to operate at as close to 100% duty cycle as possible, so long as the voltage between BST and SW exceeds 1.4V. If this voltage drops below 1.34V, the HS-FET turns off via a UVLO circuit. This allows the LS-FET to conduct, and refresh the charge on C_{BST} . If V_{IN} drops, the HS-FET continues to operate as close to 100% duty as possible to maintain output regulation, until the voltage between BST and SW falls below 1.34V.

Since the supply current sourced from C_{BST} is low, the HS-FET can remain on for more switching cycles than are required to refresh the capacitor. This means the effective duty cycle of the switching regulator is high.

The effective duty cycle during regulator dropout is primarily influenced by the voltage drops across the power MOSFET, inductor resistance, low-side diode, and PCB resistance.

Start-Up and Shutdown

If both V_{IN} and the EN voltage (V_{EN}) exceed their respective thresholds, the device starts up. First, the reference block turns on and generates a stable current and V_{REF} . Then the internal regulator turns on. The regulator provides a stable supply for the remaining circuitry.

While the internal supply rail is up, an internal timer keeps the power MOSFET off for about 50 μ s to blank any start-up glitches. When the soft-start block turns on, it keeps V_{SS} low to ensure all circuitries are ready. Then V_{SS} slowly ramps up.

Three events can shut down the chip: EN going low, V_{IN} UVLO, and thermal shutdown. During shutdown, the signaling path is blocked first to avoid any accidental fault triggering, then V_{COMP} and the internal supply rail are pulled down. The floating driver is not subject to this shutdown command, but its charging path is disabled.

APPLICATION INFORMATION

Setting the Output Voltage

The external resistor divider connected to the FB pin sets V_{OUT} (see the Typical Application Circuits section on page 31). The feedback resistor (R1) must account for both stability and dynamic response, and therefore must not be too large or too small. Choose an R1 value of about 40k Ω . Then R2 can be estimated with Equation (2):

$$R2 = \frac{R1}{\frac{V_{OUT}}{0.8} - 1} \quad (2)$$

Figure 4 shows the recommended T-type feedback network.

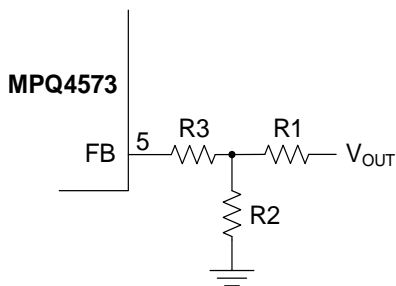

Figure 4: Feedback Network

$R3 + R1$ sets the loop bandwidth. A higher $R3 + R1$ indicates a lower bandwidth. To ensure loop stability, it is recommended to limit the bandwidth below 10% of f_{sw} , and no higher than 100kHz.

The calculated resistance may need fine-tuning via bench testing. Table 2 lists the recommended feedback divider resistor values for common output voltages. Use check loop analysis before using the device in an application, and change the resistance of R3 for loop stability if necessary.

Table 2: Recommended Resistor Values for Common V_{OUT}

V_{OUT} (V)	R1 (k Ω)	R2 (k Ω)	R3 (k Ω)
3.3	41.2	13	20
5.0	41.2	7.68	20
8	41.2	4.53	20
12	41.2	2.98	20

Selecting the Inductor

The inductor must supply constant current to the output load while being driven by the switching V_{IN} . For the highest efficiency, choose an inductor with a low DC resistance.

A larger-value inductor offers less ripple current and lower output ripple voltage; however, a larger-value inductor also results in a physically larger inductor, higher series resistance, and lower saturation current.

To determine the ideal inductance, it is recommended to allow the inductor ripple current to be approximately 30% of the maximum load current. Ensure that the peak I_L is below the device's peak current limit. The inductance (L) can be calculated with Equation (3):

$$L = \frac{V_{OUT}}{f_{SW} \times \Delta I_L} \times \left(1 - \frac{V_{OUT}}{V_{IN}}\right) \quad (3)$$

Where ΔI_L is the peak-to-peak inductor ripple current.

Choose an inductor that will not saturate under the maximum inductor peak current. The peak inductor current (I_{LP}) can be calculated with Equation (4):

$$I_{LP} = I_{OUT} + \frac{V_{OUT}}{2f_{SW} \times L} \times \left(1 - \frac{V_{OUT}}{V_{IN}}\right) \quad (4)$$

Selecting the Input Capacitor (C_{IN})

The step-down converter has a discontinuous input current, and requires a capacitor to supply the AC to the converter while maintaining the DC V_{IN} . For the best performance, use low-ESR capacitors. Ceramic capacitors with X5R or X7R dielectrics are strongly recommended due to their low ESR and small temperature coefficients. Other capacitors, such as Y5V and Z5U, should not be used since they lose too much capacitance with frequency, temperature, and bias voltage.

Place the input capacitor (C_{IN}) as close to the V_{IN} pin as possible. For most applications, a 22 μ F capacitor is sufficient. For higher V_{OUT} , use a 47 μ F capacitor to improve system stability. To maintain a small solution size, choose a properly sized capacitor that has a voltage rating compliant with the input specifications.

Since C_{IN} absorbs the input switching current, it requires an adequate ripple current rating. The ripple current rating should not exceed the converter's maximum input ripple current. The

input ripple current (I_{CIN}) can be estimated with Equation (5):

$$I_{CIN} = I_{OUT} \times \sqrt{\frac{V_{OUT}}{V_{IN}} \times \left(1 - \frac{V_{OUT}}{V_{IN}}\right)} \quad (5)$$

The worst-case condition occurs at $V_{IN} = 2 \times V_{OUT}$, which can be calculated with Equation (6):

$$I_{CIN} = \frac{I_{OUT}}{2} \quad (6)$$

For simplification, choose a C_{IN} with an RMS current rating greater than half of the maximum load current.

C_{IN} can be electrolytic, tantalum, or ceramic. If using electrolytic or tantalum capacitors, use a small, high-quality ceramic capacitor (0.1 μ F), placed as close to the IC as possible. The input capacitance determines the input voltage ripple of the converter. If there is an input voltage ripple requirement in the system design, choose a C_{IN} that meets the relevant specifications.

The input voltage ripple caused by the capacitance can be estimated with Equation (7):

$$\Delta V_{IN} = \frac{I_{OUT}}{f_{SW} \times C_{IN}} \times \frac{V_{OUT}}{V_{IN}} \times \left(1 - \frac{V_{OUT}}{V_{IN}}\right) \quad (7)$$

The worst-case condition occurs at $V_{IN} = 2 \times V_{OUT}$, estimated with Equation (8):

$$\Delta V_{IN} = \frac{1}{4} \times \frac{I_{OUT}}{f_{SW} \times C_{IN}} \quad (8)$$

Selecting the Output Capacitor (C_{OUT})

The output capacitor (C_{OUT}) maintains the DC V_{OUT} . Ceramic capacitors with low ESR are recommended for their small size and low output voltage ripple. Electrolytic and polymer capacitors may also be used. The output voltage ripple can be estimated with Equation (9):

$$\Delta V_{OUT} = \frac{V_{OUT}}{f_{SW} \times L} \times \left(1 - \frac{V_{OUT}}{V_{IN}}\right) \times \left(R_{ESR} + \frac{1}{8f_{SW} \times C_{OUT}}\right) \quad (9)$$

Where R_{ESR} is the equivalent series resistance of C_{OUT} .

For ceramic capacitors, the capacitance dominates the impedance at the switching frequency and causes the majority of the output voltage ripple. For simplification, the output

voltage ripple can be calculated with Equation (10):

$$\Delta V_{OUT} = \frac{V_{OUT}}{8 \times f_{SW}^2 \times L \times C_{OUT}} \times \left(1 - \frac{V_{OUT}}{V_{IN}}\right) \quad (10)$$

For tantalum or electrolytic capacitors, the ESR dominates the impedance at the switching frequency. For simplification, the output ripple can be calculated with Equation (11):

$$\Delta V_{OUT} = \frac{V_{OUT}}{f_{SW} \times L} \times \left(1 - \frac{V_{OUT}}{V_{IN}}\right) \times R_{ESR} \quad (11)$$

Another consideration for output capacitance is the allowable V_{OUT} overshoot if the load is suddenly removed. In this case, energy stored in the inductor is transferred to C_{OUT} , causing its voltage to rise. To achieve the desired overshoot relative to the regulated voltage, C_{OUT} can be estimated with Equation (12):

$$C_{OUT} = \frac{I_{OUT}^2 \times L}{V_{OUT}^2 \times \left[\left(\frac{V_{OUT_MAX}}{V_{OUT}}\right)^2 - 1\right]} \quad (12)$$

Where V_{OUT_MAX} / V_{OUT} is the maximum allowable overshoot.

After calculating the capacitance required for both ripple and overshoot requirements, choose the larger value.

The characteristics of C_{OUT} also affect the stability of the regulation system. The MPQ4573 can be optimized for a wide range of capacitance and ESR values.

Setting V_{IN} Under-Voltage Lockout (UVLO)

The MPQ4573 has an internal, fixed UVLO threshold. The rising threshold is 4V, and the falling threshold is about 3.5V. For applications that require a higher UVLO point, place an external resistor divider between EN and V_{IN} to obtain a higher equivalent UVLO threshold (see Figure 5 and Figure 6 on page 29). If the EN pin is connected to V_{IN} through a resistor, add a 6V Zener diode between EN and GND.

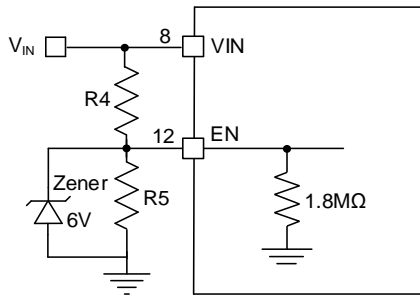

Figure 5: Adjustable UVLO via the EN Divider if V_{EN} Rises

When V_{EN} is rising, the UVLO threshold can be calculated with Equation (13):

$$V_{IN_UV_RISE} = \left(1 + \frac{R4}{1.8M\Omega // R5}\right) \times V_{EN_RISING} \quad (13)$$

Where V_{EN_RISING} is 1.45V.

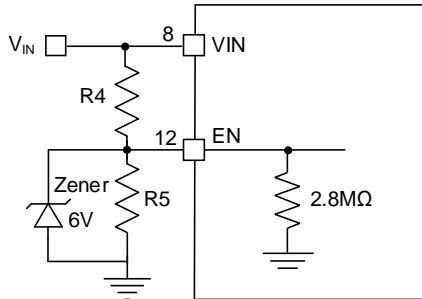

Figure 6: Adjustable UVLO via the EN Divider if V_{EN} Falls

When V_{EN} is falling, the UVLO threshold can be calculated with Equation (14):

$$V_{IN_UV_FALL} = \left(1 + \frac{R4}{2.8M\Omega // R5}\right) \times V_{EN_FALLING} \quad (14)$$

Where $V_{EN_FALLING}$ is 1.12V.

Choose an $R4$ that is big enough to limit the current flowing into EN to below 100 μ A.

Bootstrap (BST) Resistor and Capacitor

A resistor (R_{BST}) in series with C_{BST} can reduce SW's rising rate and voltage spikes. This improves EMI performance and reduces voltage stress at a high V_{IN} . A higher resistance is better for SW spike reduction, but can compromise efficiency. To make a tradeoff between EMI and efficiency, it is recommended to keep R_{BST} below 20 Ω . The recommended C_{BST} value is between 0.1 μ F and 1 μ F.

PCB Layout Guidelines ⁽¹⁰⁾

Efficient PCB layout is critical for stable operation. It is strongly recommended to use a 4-layer layout to improve thermal performance. For the best results, refer to Figure 7 and follow the guidelines below:

1. Place the high-current paths (GND, VIN, and SW) very close to the device with short, direct, and wide traces.
2. Use large copper areas to minimize conduction loss and thermal stress.
3. To minimize high-frequency noise, place the ceramic input capacitors as close to VIN and GND as possible.
4. To ensure that the FB trace is as short as possible, place the T-type FB resistors as close to the FB pin as possible.
5. Route SW and BST away from sensitive analog areas, such as FB.
6. Use multiple vias to connect the power planes to the internal layer.

Note:

10) The recommended PCB layout is based on Figure 8 in the Typical Application Circuits section on page 31.

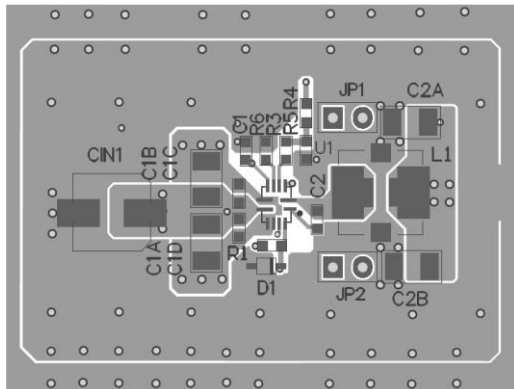
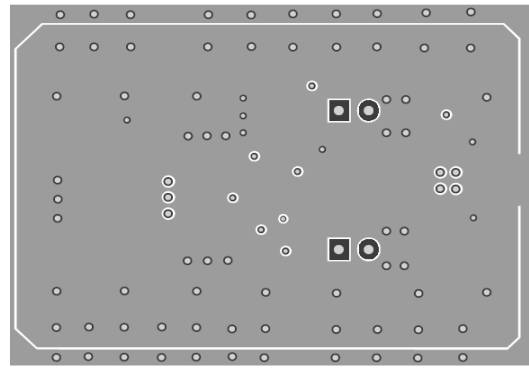
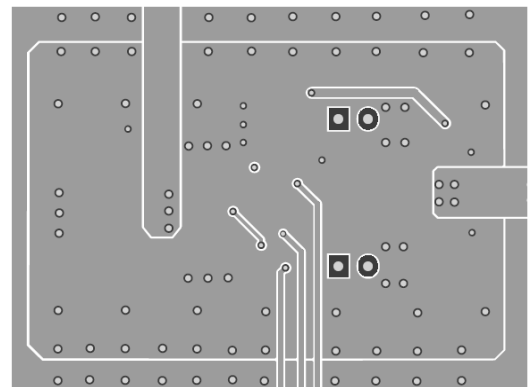
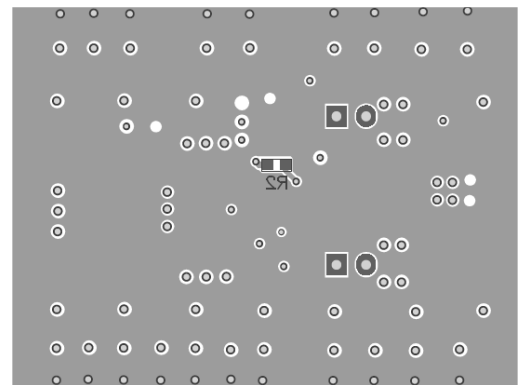
Top Silk and Top Layer

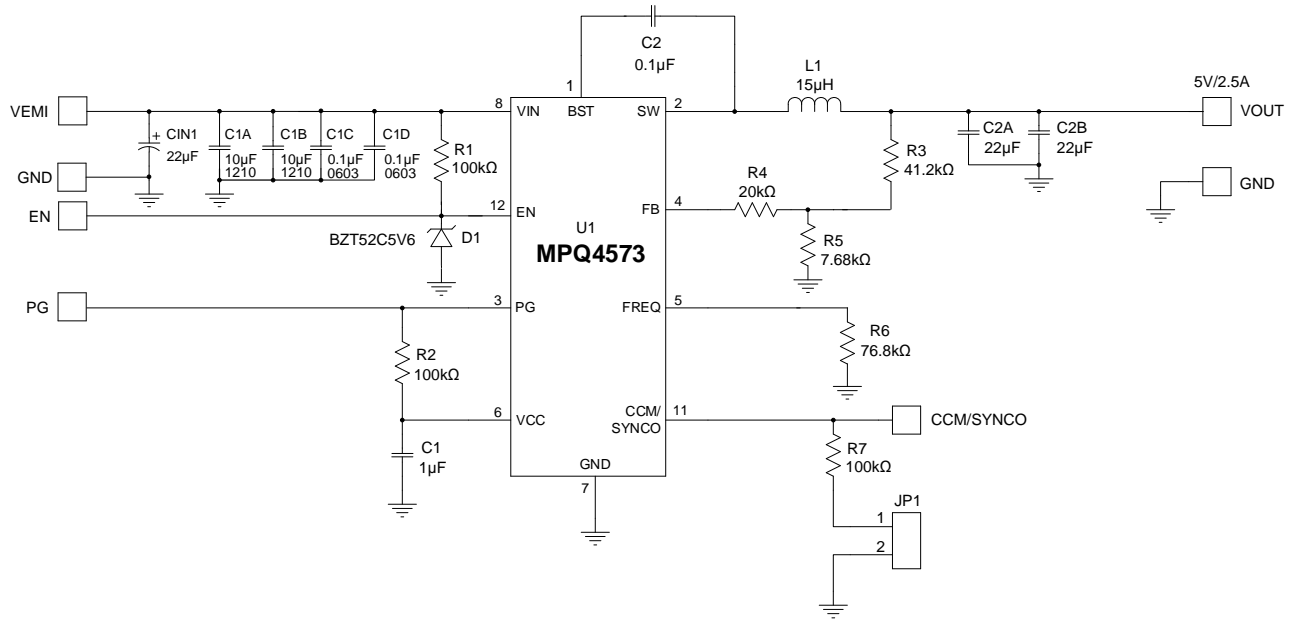
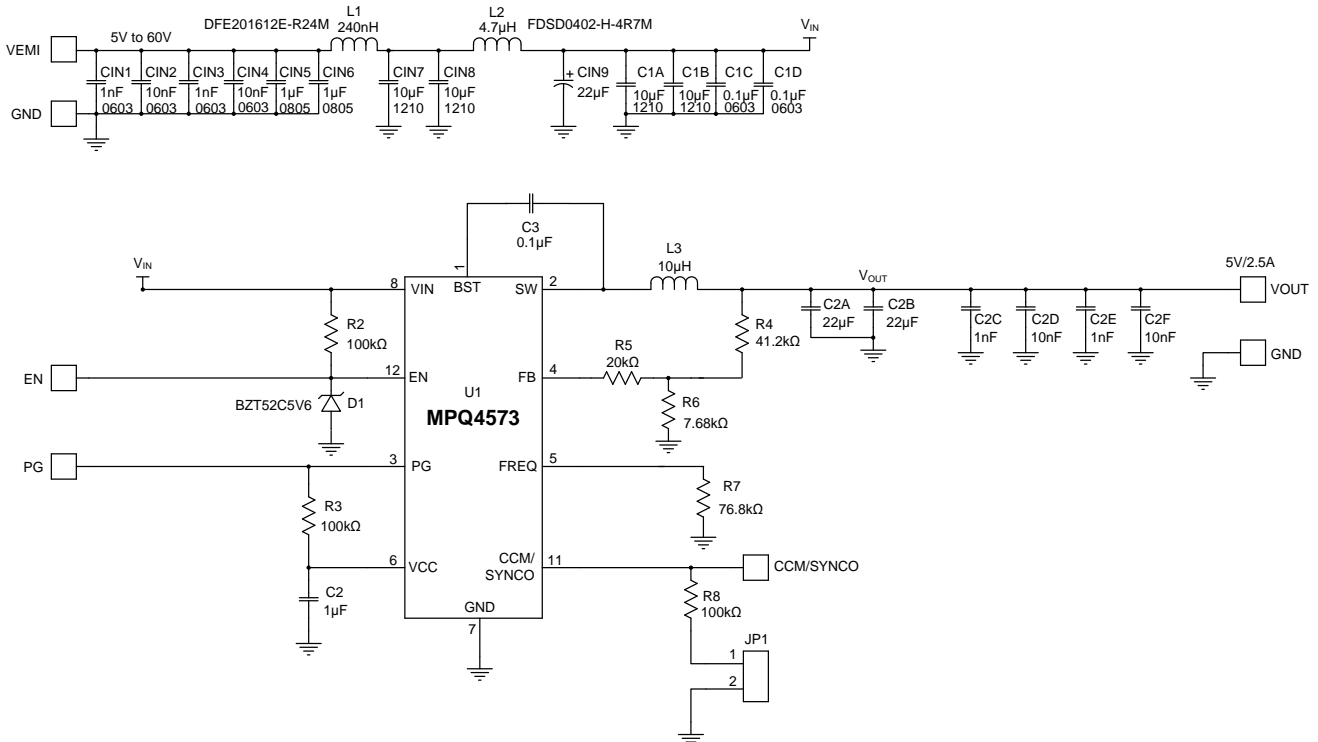
Mid-Layer 1

Mid-Layer 2

Bottom Layer and Bottom Silk
Figure 7: Recommended PCB Layout

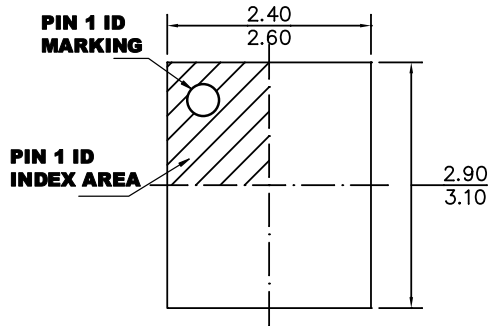
TYPICAL APPLICATION CIRCUITS

Figure 8: Typical Application Circuit

Figure 9: Typical Application Circuit with EMI Filters

PACKAGE INFORMATION

QFN-12 (2.5mmx3mm) Wettable Flank

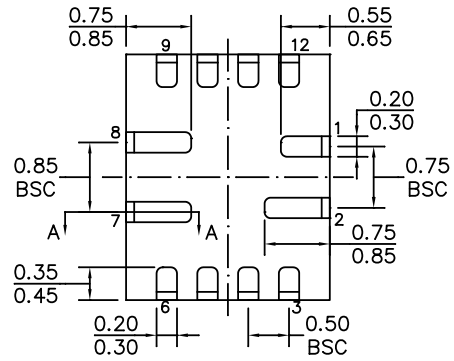

TOP VIEW



BOTTOM VIEW

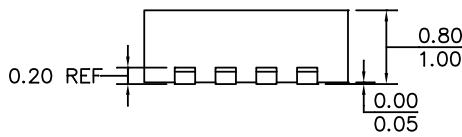

SIDE VIEW

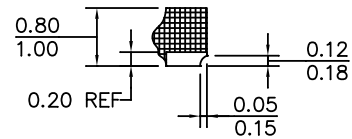

SECTION A-A

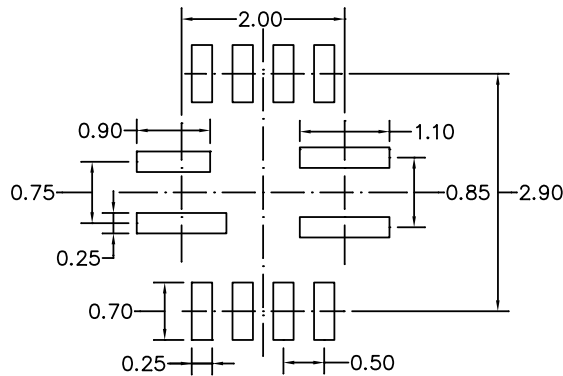

RECOMMENDED LAND PATTERN

NOTE:

- 1) THE LEAD SIDE IS WETTABLE.
- 2) THE LAND PATTERNS OF PINS 2, 7, AND 8 HAVE THE SAME LENGTH AND WIDTH.
- 3) ALL DIMENSIONS ARE IN MILLIMETERS.
- 4) LEAD COPLANARITY SHALL BE 0.08 MILLIMETERS MAX.
- 5) JEDEC REFERENCE IS MO-220.
- 6) DRAWING IS NOT TO SCALE.

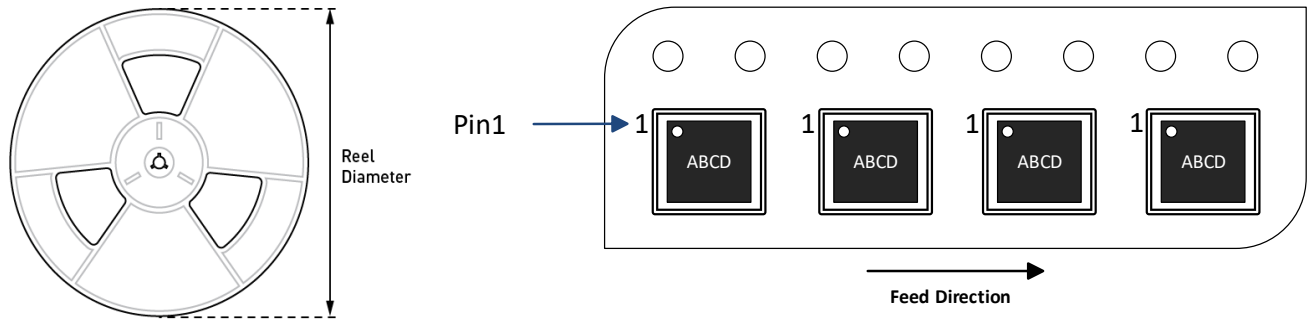
CARRIER INFORMATION

Part Number	Package Description	Quantity/ Reel	Quantity/ Tube	Quantity/ Tray	Reel Diameter	Carrier Tape Width	Carrier Tape Pitch
MPQ4573GQBE-Z	QFN-12 (2.5mmx3mm)	5000	N/A	N/A	13in	12mm	8mm
MPQ4573GQBE-AEC1-Z							



REVISION HISTORY

Revision #	Revision Date	Description	Pages Updated
1.0	3/19/2021	Initial Release	-

Notice: The information in this document is subject to change without notice. Please contact MPS for current specifications. Users should warrant and guarantee that third-party Intellectual Property rights are not infringed upon when integrating MPS products into any application. MPS will not assume any legal responsibility for any said applications.