

描述 / Descriptions

TO-92 塑封封装 NPN 半导体三极管。Silicon NPN transistor in a TO-92 Plastic Package.

特征 / Features

V_{CEO} 小于 80V。

$V_{CEO} < 80V.$ ($I_C = 1mA$).

用途 / Applications

用于一般放大电路。

General purpose amplifier.

内部等效电路 / Equivalent Circuit

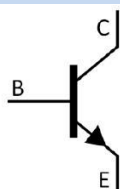

引脚排列 / Pinning



PIN 1 : Collector PIN 2 : Base PIN 3 : Emitter

放大及印章代码 / hFE Classifications & Marking

见印章说明。See Marking Instructions.

极限参数 / Absolute Maximum Ratings(Ta=25°C)

参数 Parameter	符号 Symbol	数值 Rating	单位 Unit
Collector to Base Voltage	V_{CBO}	80	V
Collector to Emitter Voltage	V_{CEO}	80	V
Emitter to Base Voltage	V_{EBO}	5	V
Collector Current - Continuous	I_C	500	mA
Peak Collector Current	I_{CM}	1	A
Peak Base Current	I_{BM}	200	mA
Collector Power Dissipation	P_C	625	mW
Junction Temperature	T_j	150	°C
Storage Temperature Range	T_{stg}	-55~150	°C

电性能参数 / Electrical Characteristics(Ta=25°C)

参数 Parameter	符号 Symbol	测试条件 Test Conditions	最小值 Min	典型值 Typ	最大值 Max	单位 Unit
Collector Cut-Off Current	I_{CBO}	$V_{CB}=80V$ $I_E=0$			0.05	μA
Emitter Cut-Off Current	I_{EBO}	$V_{EB}=5$ $I_C=0$			0.05	μA
DC Current Gain	$h_{FE(1)}$	$V_{CE}=1V$ $I_C=100mA$	100			
	$h_{FE(2)}$	$V_{CE}=1V$ $I_C=10mA$	100			
Collector to Emitter Saturation Voltage	$V_{CE(sat)}$	$I_C=100mA$ $I_B=10mA$			0.25	V
Base to Emitter Voltage	V_{BE}	$V_{CE}=1V$ $I_C=100mA$			1.2	V
Transition Frequency	f_T	$V_{CE}=2V$ $I_C=10mA$ $f=100MHz$	100			MHz

电参数曲线图 / Electrical Characteristic Curve

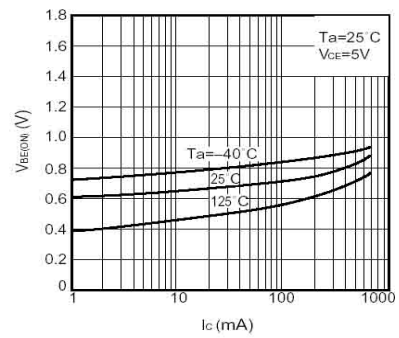
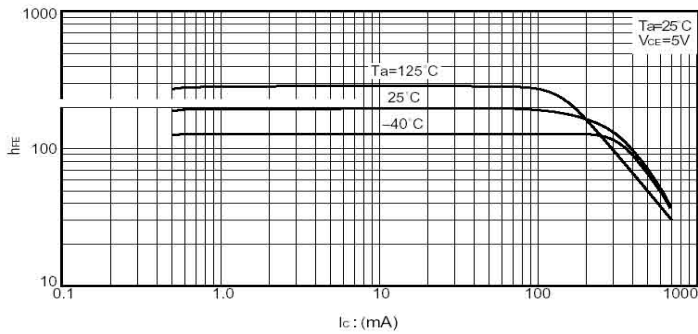
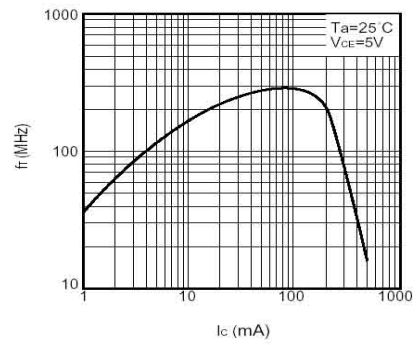
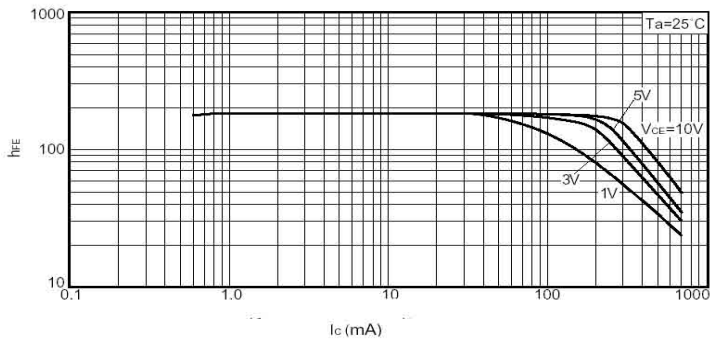
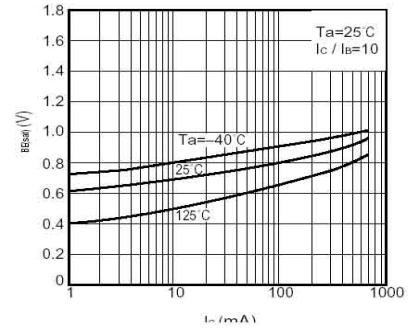
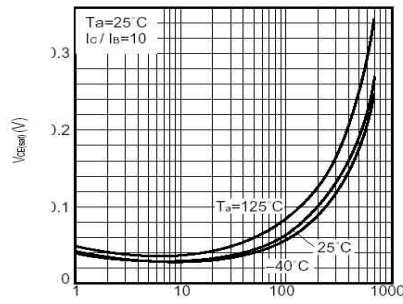
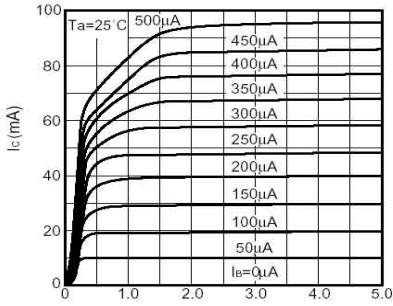

外形尺寸图 / Package Dimensions

TO-92

Unit: mm

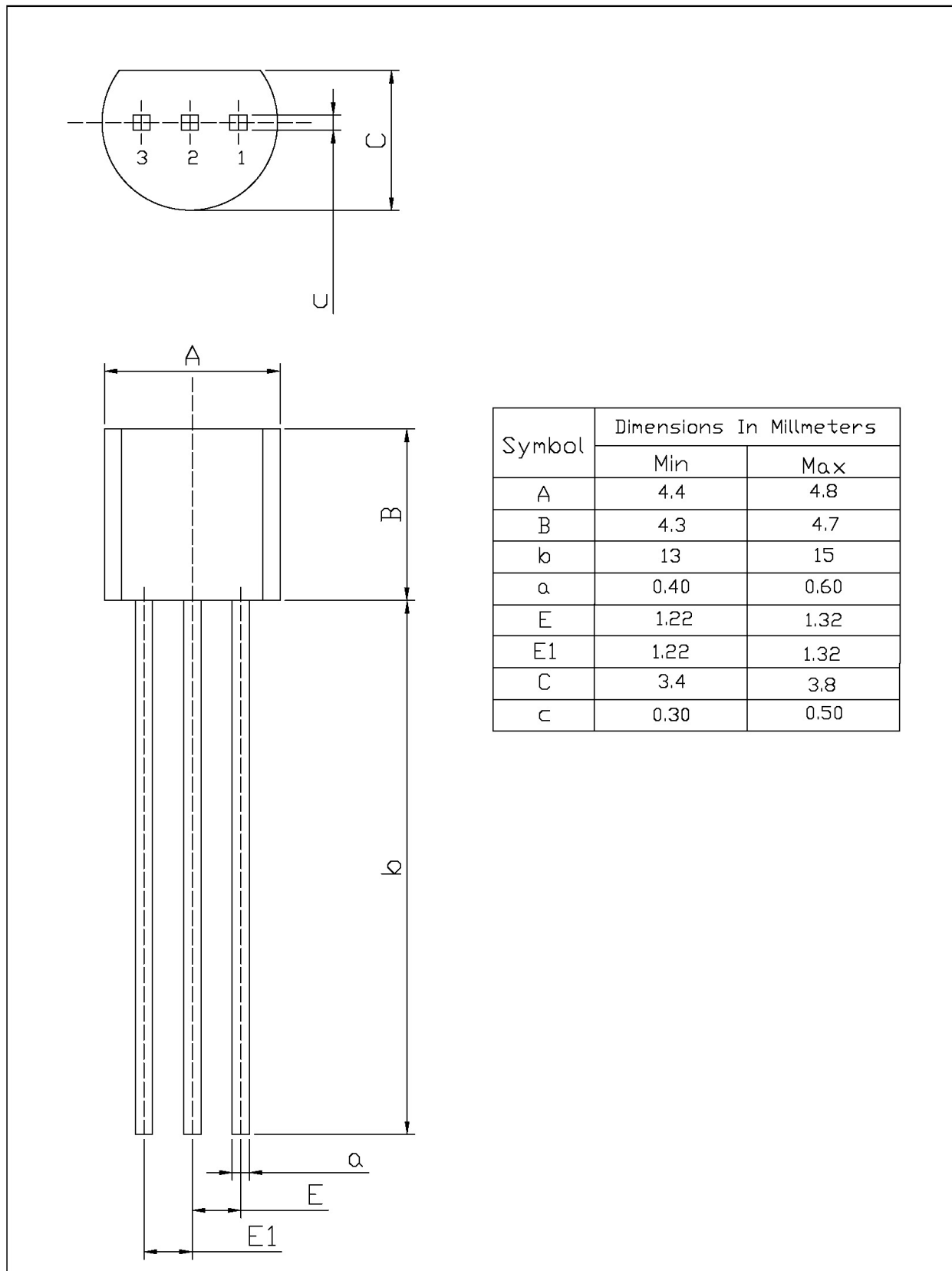

印章说明 / Marking Instructions

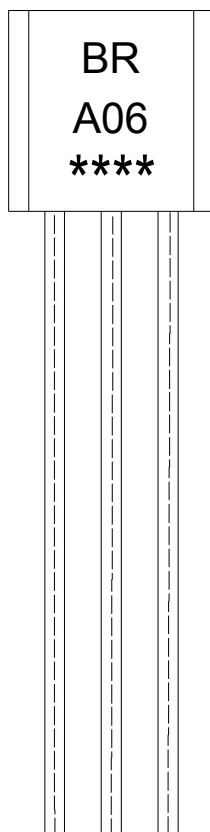

说明：

BR: 为公司代码

A06 : 为型号代码

**** : 为生产批号代码，随生产批号变化。

Note:

BR: Company Code.

A06: Product Type.

****: Lot No. Code,code change with Lot No.

波峰焊温度曲线图(无铅) / Temperature Profile for Dip Soldering(Pb-Free)



说明：

- 1、预热温度 25 ~ 150°C，时间 60 ~ 90sec;
- 2、峰值温度 255±5°C，时间持续为 5±0.5sec;
- 3、焊接制程冷却速度为 2 ~ 10°C/sec.

Note:

- 1.Preheating:25~150°C, Time:60~90sec.
- 2.Peak Temp.:255±5°C, Duration:5±0.5sec.
3. Cooling Speed: 2~10°C/sec.

耐焊接热试验条件 / Resistance to Soldering Heat Test Conditions

温度：270±5°C

时间：10±1 sec.

Temp:270±5°C

Time:10±1 sec

包装规格 / Packaging SPEC.

散件包装 / BULK

Package Type 封装形式	Units 包装数量					Dimension 包装尺寸 (unit: mm3)		
	Units/Bag 只/袋	Bags/Inner Box 袋/盒	Units/Inner Box 只/盒	Inner Boxes/Outer Box 盒/箱	Units/Outer Box 只/箱	Bag 袋	Inner Box 盒	Outer Box 箱
TO-92	1,000	10	10,000	5	50,000	135×190	237×172×102	560×245×195
	1,000	10	10,000	10	100,000	135×190	237×172×102	560×245×375

编带包装 / AMMO

Package Type 封装形式	Units 包装数量					Dimension 包装尺寸 (unit: mm3)	
	Units/tape 只/纸带	Tape/Inner Box 纸带/盒	Rows/Inner Box 纸带层/盒	Inner Boxes/Outer Box 盒/箱	Units/Outer Box 只/箱	Inner Box 盒	Outer Box 箱
TO-92	3,000	1	120	10	30,000	328×230×42	小箱 480×346×235, 大箱 547×407×268

使用说明 / Notices