

## 描述 / Descriptions

TO-251 塑封封装 NPN 半导体三极管。Silicon NPN transistor in a TO-251 Plastic Package.

## 特征 / Features

耐压高,饱和压降低,集电极输出电容低,与 MPSA92I 互补。

High voltage, Low saturation voltage, low collector capacitance output, complementary pair with MPSA92I.

## 用途 / Applications

高电压控制电路。

High voltage control circuit.

## 内部等效电路 / Equivalent Circuit

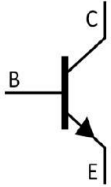

## 引脚排列 / Pinning

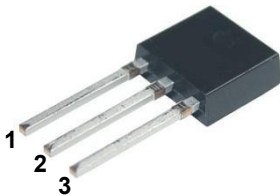

PIN1 : Base      PIN 2 : Collector      PIN 3 : Emitter

## 放大及印章代码 / $h_{FE}$ Classifications & Marking

见印章说明。See Marking Instructions.

**极限参数 / Absolute Maximum Ratings(Ta=25°C)**

参数 Parameter	符号 Symbol	数值 Rating	单位 Unit
Collector to Base Voltage	$V_{CBO}$	300	V
Collector to Emitter Voltage	$V_{CEO}$	300	V
Emitter to Base Voltage	$V_{EBO}$	6.0	V
Collector Current - Continuous	$I_C$	500	mA
Collector Power Dissipation	$P_C$	625	mW
Junction Temperature	$T_j$	150	°C
Storage Temperature Range	$T_{stg}$	-55~150	°C

**电性能参数 / Electrical Characteristics(Ta=25°C)**

参数 Parameter	符号 Symbol	测试条件 Test Conditions	最小值 Min	典型值 Typ	最大值 Max	单位 Unit
Collector to Base Breakdown Voltage	$V_{CBO}$	$I_C=100\mu A$ $I_E=0$	300			V
Collector to Emitter Breakdown Voltage	$V_{CEO}$	$I_C=1.0mA$ $I_B=0$	300			V
Emitter to Base Breakdown Voltage	$V_{EBO}$	$I_E=100\mu A$ $I_C=0$	6.0			V
Collector Cut-Off Current	$I_{CBO}$	$V_{CB}=200V$ $I_E=0$			0.1	$\mu A$
Emitter Cut-Off Current	$I_{EBO}$	$V_{BE}=6.0V$ $I_C=0$			0.1	$\mu A$
DC Current Gain	$h_{FE(1)}$	$V_{CE}=10V$ $I_C=10mA$	40			
	$h_{FE(2)}$	$V_{CE}=10V$ $I_C=30mA$	40			
	$h_{FE(3)}$	$V_{CE}=10V$ $I_C=1.0mA$	25			
Collector to Emitter Saturation Voltage	$V_{CE(sat)}$	$I_C=20mA$ $I_B=2.0mA$			0.5	V
Base to Emitter Saturation Voltage	$V_{BE(sat)}$	$I_C=20mA$ $I_B=2.0mA$			0.9	V
Transition Frequency	$f_T$	$V_{CE}=20V$ $f=100MHz$ $I_C=10mA$	50			MHz
Collector output capacitance	$C_{ob}$	$V_{CB}=20V$ $f=1.0MHz$ $I_E=0$			3.0	pF

电参数曲线图 / Electrical Characteristic Curve

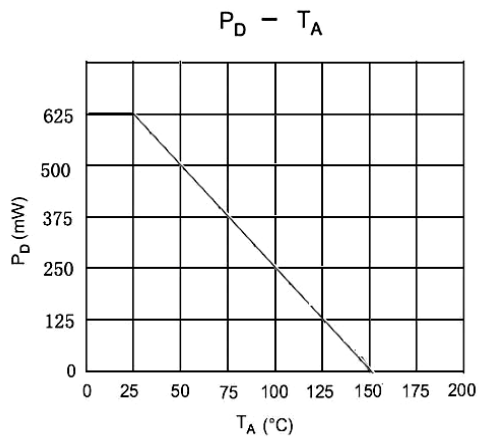
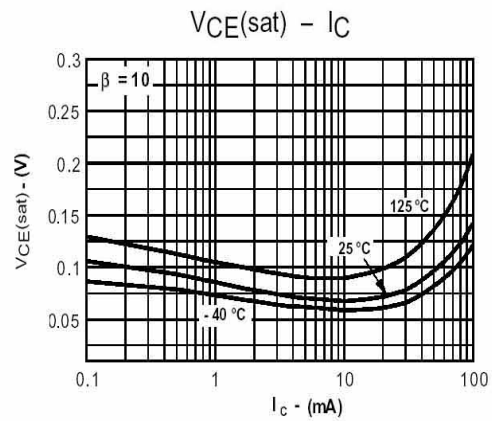
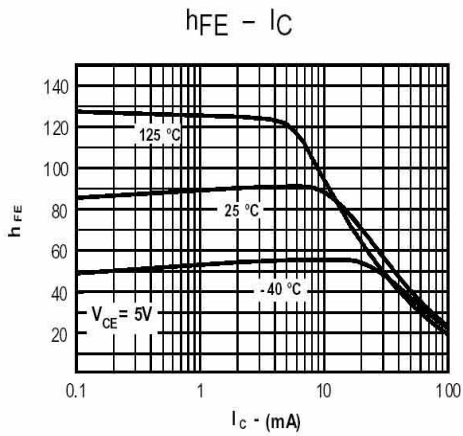
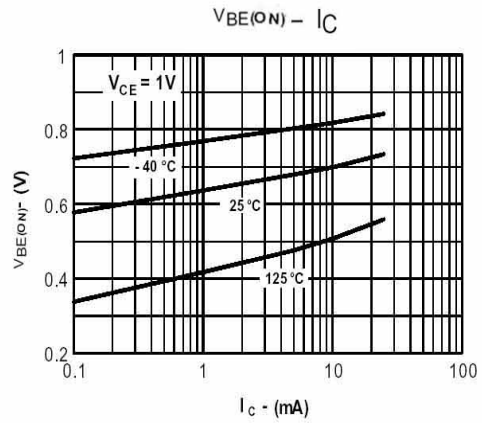
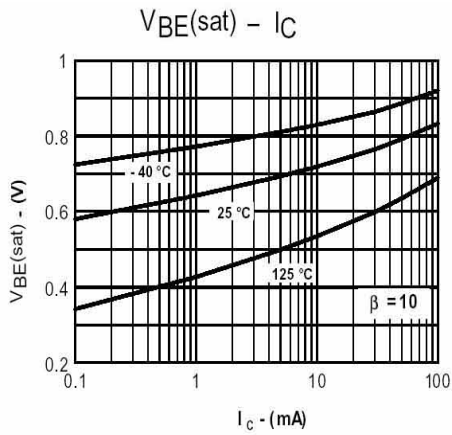

外形尺寸图 / Package Dimensions

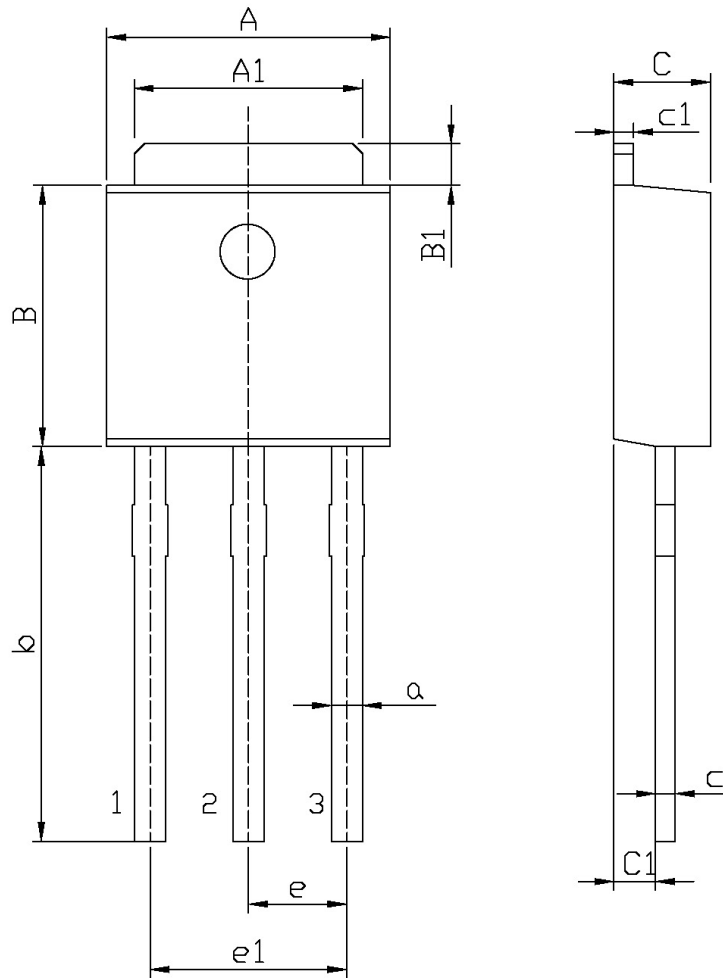

单位: mm

Symbol	Dimensions In Millimeters		Symbol	Dimensions In Millimeters	
	Min	Max		Min	Max
A	6.45	6.75	a	0.50	0.70
A1	5.10	5.50	b	9.00	9.40
B	5.95	6.25	c	0.45	0.55
B1	0.95	1.25	c1	0.45	0.55
C	2.20	2.40	e	2.24	2.34
C1	0.95	1.15	e1	4.43	4.73

TO-251

印章说明 / Marking Instructions

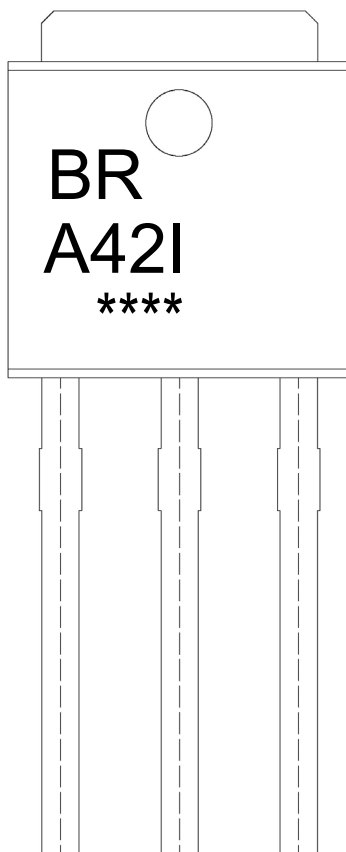

说明：

BR： 为公司代码

A42I： 为型号代码

\*\*\*\*： 为生产批号代码，随生产批号变化。

Note:

BR: Company Code

A42I: Product Type.

\*\*\*\*: Lot No. Code, code change with Lot No.

**波峰焊温度曲线图(无铅) / Temperature Profile for Dip Soldering(Pb-Free)**



说明：

- 1、预热温度 25 ~ 150°C，时间 60 ~ 90sec；
- 2、峰值温度 255±5°C，时间持续为 5±0.5sec；
- 3、焊接制程冷却速度为 2 ~ 10°C/sec.

Note:

- 1.Preheating:25~150°C, Time:60~90sec.
- 2.Peak Temp.:255±5°C, Duration:5±0.5sec.
3. Cooling Speed: 2~10°C/sec.

**耐焊接热试验条件 / Resistance to Soldering Heat Test Conditions**

温度：270±5°C

时间：10±1 sec.

Temp.:270±5°C

Time:10±1 sec

**包装规格 / Packaging SPEC.**

散件包装 / BULK

Package Type 封装形式	Units 包装数量					Dimension 包装尺寸 (unit: mm <sup>3</sup> )		
	Units/Bag 只/袋	Bags/Inner Box 袋/盒	Units/Inner Box 只/盒	Inner Boxes/Outer Box 盒/箱	Units/Outer Box 只/箱	Bag 袋	Inner Box 盒	Outer Box 箱
TO-251	1,000	10	10,000	5	50,000	135×190	237×172×102	560×245×195

套管包装 / TUBE

Package Type 封装形式	Units 包装数量					Dimension 包装尺寸 (unit: mm <sup>3</sup> )		
	Units/Tube 只/套管	Tubes/Inner Box 套管/盒	Units/Inner Box 只/盒	Inner Boxes/Outer Box 盒/箱	Units/Outer Box 只/箱	Tube 套管	Inner Box 盒	Outer Box 箱
TO-251/252	75	48	3,600	5	18,000	526×20.5×5.25	555×164×50	575×290×180

**使用说明 / Notices**