

### Driver PNP Transistors

 Lead(Pb)-Free

TO-92

1. EMITTER  
2. BASE  
3. COLLECTOR

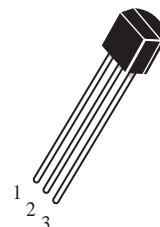

### ABSOLUTE MAXIMUM RATINGS (Ta=25°C)

Rating	Symbol	MPSA55	MPSA56	Unit
Collector-Emitter Voltage	V <sub>CEO</sub>	-60	-80	Vdc
Collector-Base Voltage	V <sub>CBO</sub>	-60	-80	Vdc
Emitter-Base Voltage	V <sub>EBO</sub>	-4.0		Vdc
Collector Current	I <sub>C</sub>	-500		mAdc
Total Device Dissipation T <sub>A</sub> =25°C	P <sub>D</sub>	0.625		W
Junction Temperature	T <sub>j</sub>	150		°C
Storage, Temperature	T <sub>stg</sub>	-55 to +150		°C

### ELECTRICAL CHARACTERISTICS

Characteristics	Symbol	Min	Max	Unit
Collector-Emitter Breakdown Voltage (I <sub>C</sub> = -1.0 mAdc, I <sub>E</sub> =0) MPSA55 MPSA56	V <sub>(BR)CEO</sub>	-60 -80	-	Vdc
Collector-Base Breakdown Voltage (I <sub>C</sub> = -100 uAdc, I <sub>E</sub> =0) MPSA55 MPSA56	V <sub>(BR)CBO</sub>	-60 -80	-	Vdc
Emitter-Base Breakdown Voltage (I <sub>E</sub> = -100 uAdc, I <sub>C</sub> =0)	V <sub>(BR)EBO</sub>	-4.0	-	Vdc
Collector Cutoff Current (V <sub>CE</sub> = 50 Vdc, I <sub>B</sub> =0) MPSA55 (V <sub>CE</sub> = 60 Vdc, I <sub>B</sub> =0) MPSA56	I <sub>CEO</sub>	-	-0.1	uAdc
Collector Cutoff Current (V <sub>CE</sub> = -60 Vdc, I <sub>B</sub> =0) MPSA55 (V <sub>CE</sub> = -80 Vdc, I <sub>B</sub> =0) MPSA56	I <sub>CBO</sub>	-	-0.1	uAdc
Emitter Cutoff Current (V <sub>EB</sub> = -3.0Vdc, I <sub>C</sub> =0)	I <sub>EBO</sub>	-	-0.1	uAdc

**ELECTRICAL CHARACTERISTICS** ( $T_A=25^\circ\text{C}$  unless otherwise noted) (Continued)

Characteristics	Symbol	Min	TYP	Max	Unit
-----------------	--------	-----	-----	-----	------

**ON CHARACTERISTICS**

DC Current Gain ( $I_C = -100\text{ mA}$ , $V_{CE} = 1.0\text{ Vdc}$ )	$h_{FE} (1)$	100	-	-	-
Collector-Emitter Saturation Voltage ( $I_C = -100\text{ mA}$ , $I_B = -10\text{ mA}$ )	$V_{CE(sat)}$	-	-	-0.25	Vdc
Base-Emitter Saturation Voltage ( $I_C = -100\text{ mA}$ , $I_B = -10\text{ mA}$ )	$V_{BE(sat)}$	-	-	-1.2	Vdc
Current-Gain-Bandwidth Product ( $I_C = -10\text{ mA}$ , $V_{CE} = -2.0\text{ Vdc}$ , $f = 100\text{ MHz}$ )	$f_T$	100	-	-	MHz

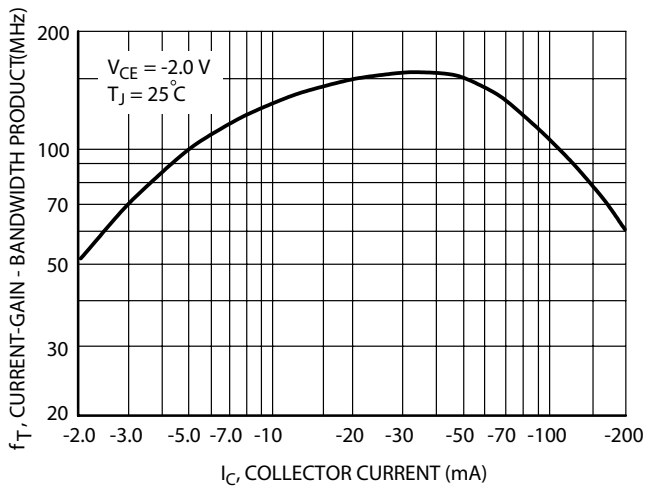

FIG1. Current-Gain Bandwidth Product

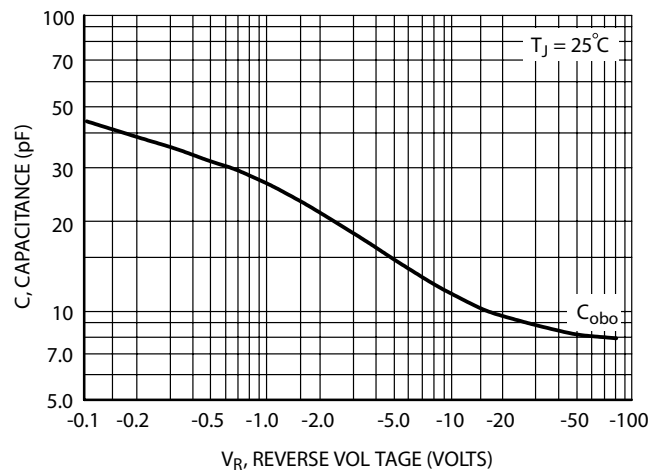

FIG2. Capacitance

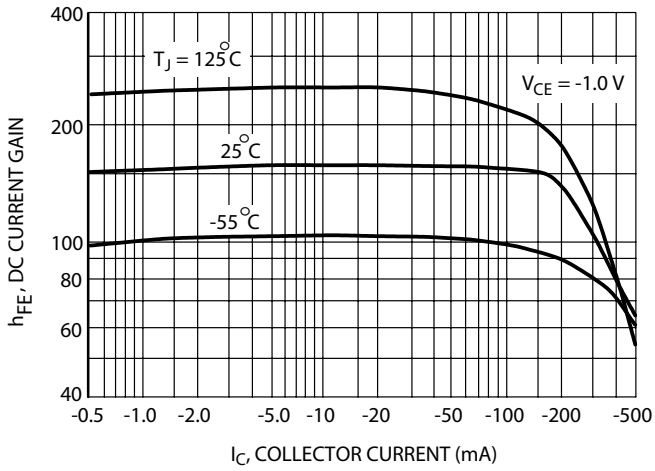

FIG3. DC Current Gain

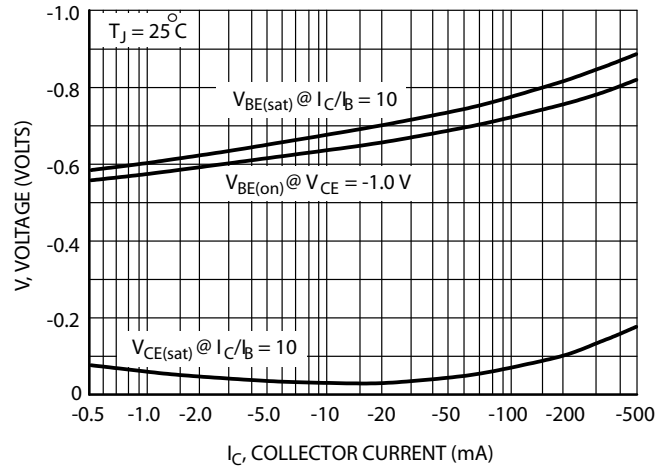

FIG4. "ON" Voltages

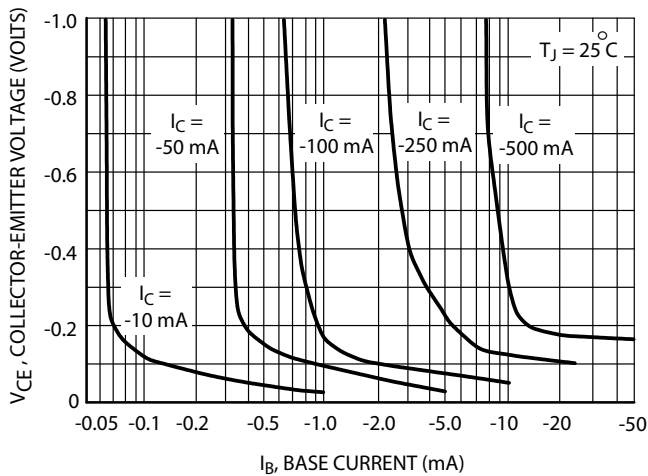

FIG5. Collector Saturation Region

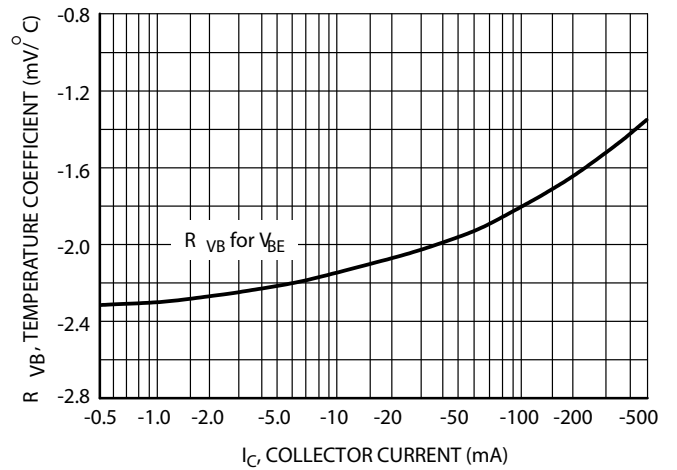
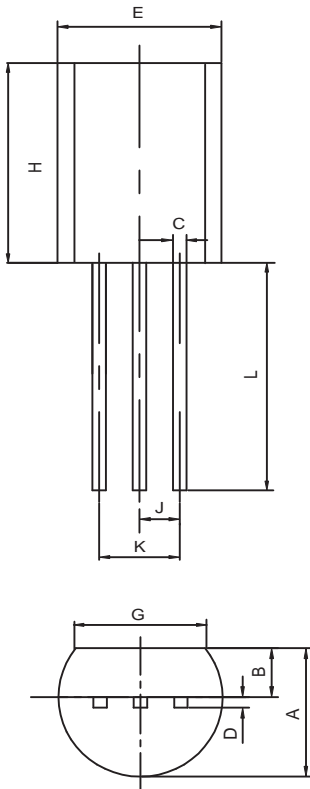

FIG6. Base-Emitter Temperature Coefficient

**TO-92 Outline Dimensions**

unit:mm



<b>TO-92</b>		
<b>Dim</b>	<b>Min</b>	<b>Max</b>
<b>A</b>	3.30	3.70
<b>B</b>	1.10	1.40
<b>C</b>	0.38	0.55
<b>D</b>	0.36	0.51
<b>E</b>	4.40	4.70
<b>G</b>	3.43	-
<b>H</b>	4.30	4.70
<b>J</b>	1.270TYP	
<b>K</b>	2.44	2.64
<b>L</b>	14.10	14.50