

MPSW01, MPSW01A

One Watt High Current Transistors

NPN Silicon

Features

- Pb-Free Packages are Available*

MAXIMUM RATINGS

Rating	Symbol	Value	Unit
Collector - Emitter Voltage MPSW01 MPSW01A	V_{CE0}	30 40	Vdc
Collector - Base Voltage MPSW01 MPSW01A	V_{CB0}	40 50	Vdc
Emitter - Base Voltage	V_{EB0}	5.0	Vdc
Collector Current - Continuous	I_C	1000	mAdc
Total Device Dissipation @ $T_A = 25^\circ\text{C}$ Derate above 25°C	P_D	1.0 8.0	W mW/ $^\circ\text{C}$
Total Device Dissipation @ $T_C = 25^\circ\text{C}$ Derate above 25°C	P_D	2.5 20	W mW/ $^\circ\text{C}$
Operating and Storage Junction Temperature Range	T_J, T_{stg}	-55 to +150	$^\circ\text{C}$

THERMAL CHARACTERISTICS

Characteristic	Symbol	Max	Unit
Thermal Resistance, Junction-to-Ambient	$R_{\theta JA}$	125	$^\circ\text{C}/\text{W}$
Thermal Resistance, Junction-to-Case	$R_{\theta JC}$	50	$^\circ\text{C}/\text{W}$

Stresses exceeding Maximum Ratings may damage the device. Maximum Ratings are stress ratings only. Functional operation above the Recommended Operating Conditions is not implied. Extended exposure to stresses above the Recommended Operating Conditions may affect device reliability.

*For additional information on our Pb-Free strategy and soldering details, please download the ON Semiconductor Soldering and Mounting Techniques Reference Manual, SOLDERRM/D.



ON Semiconductor®

<http://onsemi.com>

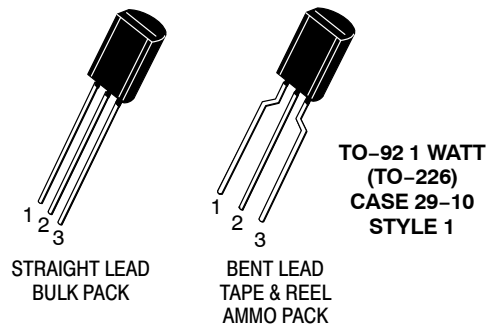
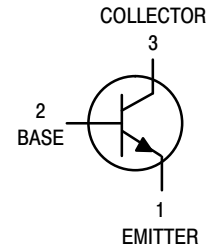

MARKING DIAGRAM

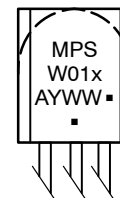

- x = 01A Devices
- A = Assembly Location
- Y = Year
- WW = Work Week
- = Pb-Free Package

(Note: Microdot may be in either location)

ORDERING INFORMATION

See detailed ordering and shipping information in the package dimensions section on page 2 of this data sheet.

MPSW01, MPSW01A

ELECTRICAL CHARACTERISTICS ($T_A = 25^\circ\text{C}$ unless otherwise noted)

Characteristic	Symbol	Min	Max	Unit
OFF CHARACTERISTICS				
Collector-Emitter Breakdown Voltage (Note 1) ($I_C = 10\text{ mA}$, $I_B = 0$)	$V_{(BR)CEO}$	30 40	- -	Vdc
Collector-Base Breakdown Voltage ($I_C = 100\text{ }\mu\text{A}$, $I_E = 0$)	$V_{(BR)CBO}$	40 50	- -	Vdc
Emitter-Base Breakdown Voltage ($I_E = 100\text{ }\mu\text{A}$, $I_C = 0$)	$V_{(BR)EBO}$	5.0	-	Vdc
Collector Cutoff Current ($V_{CB} = 30\text{ Vdc}$, $I_E = 0$) ($V_{CB} = 40\text{ Vdc}$, $I_E = 0$)	I_{CBO}	- -	0.1 0.1	μA
Emitter Cutoff Current ($V_{EB} = 3.0\text{ Vdc}$, $I_C = 0$)	I_{EBO}	-	0.1	μA

ON CHARACTERISTICS (Note 1)

DC Current Gain ($I_C = 10\text{ mA}$, $V_{CE} = 1.0\text{ Vdc}$) ($I_C = 100\text{ mA}$, $V_{CE} = 1.0\text{ Vdc}$) ($I_C = 1000\text{ mA}$, $V_{CE} = 1.0\text{ Vdc}$)	h_{FE}	55 60 50	- - -	-
Collector-Emitter Saturation Voltage ($I_C = 1000\text{ mA}$, $I_B = 100\text{ mA}$)	$V_{CE(sat)}$	-	0.5	Vdc
Base-Emitter On Voltage ($I_C = 1000\text{ mA}$, $V_{CE} = 1.0\text{ Vdc}$)	$V_{BE(on)}$	-	1.2	Vdc

SMALL-SIGNAL CHARACTERISTICS

Current-Gain — Bandwidth Product ($I_C = 50\text{ mA}$, $V_{CE} = 10\text{ Vdc}$, $f = 20\text{ MHz}$)	f_T	50	-	MHz
Output Capacitance ($V_{CB} = 10\text{ Vdc}$, $I_E = 0$, $f = 1.0\text{ MHz}$)	C_{obo}	-	20	pF

1. Pulse Test: Pulse Width $\leq 300\text{ }\mu\text{s}$, Duty Cycle $\leq 2.0\%$.

ORDERING INFORMATION

Device	Package	Shipping†
MPSW01	TO-92	5000 Units / Bulk
MPSW01G	TO-92 (Pb-Free)	5000 Units / Bulk
MPSW01AG	TO-92 (Pb-Free)	5000 Units / Bulk
MPSW01ARLRAG	TO-92 (Pb-Free)	2000 / Tape & Reel
MPSW01ARLRPG	TO-92 (Pb-Free)	2000 / Tape & Ammo Box

†For information on tape and reel specifications, including part orientation and tape sizes, please refer to our Tape and Reel Packaging Specifications Brochure, BRD8011/D.

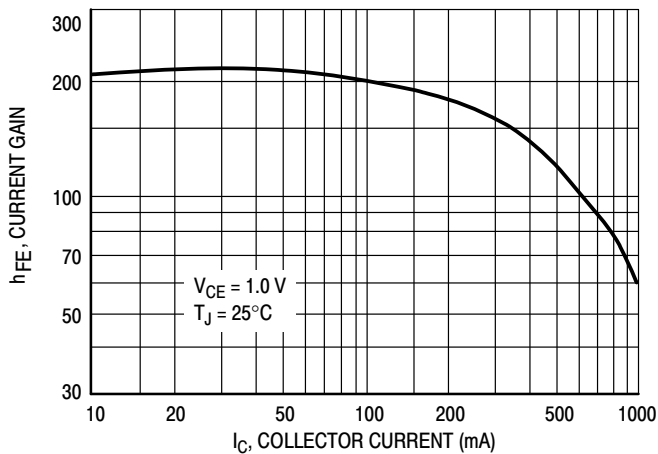

Figure 1. DC Current Gain

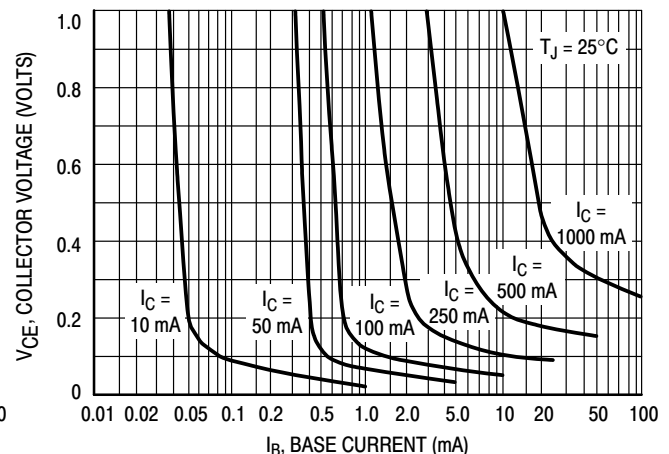

Figure 2. Collector Saturation Region

MPSW01, MPSW01A

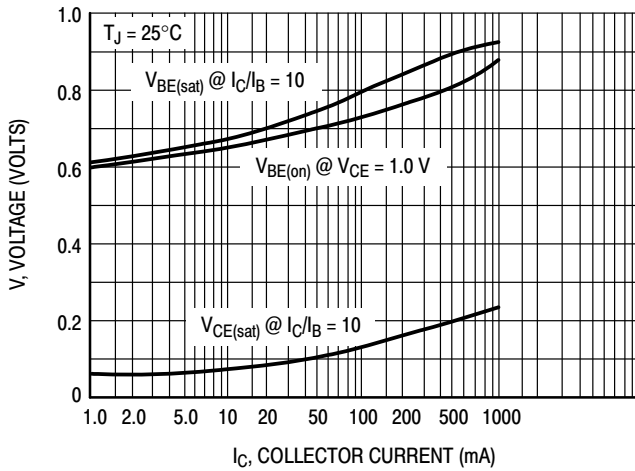

Figure 3. "ON" Voltages

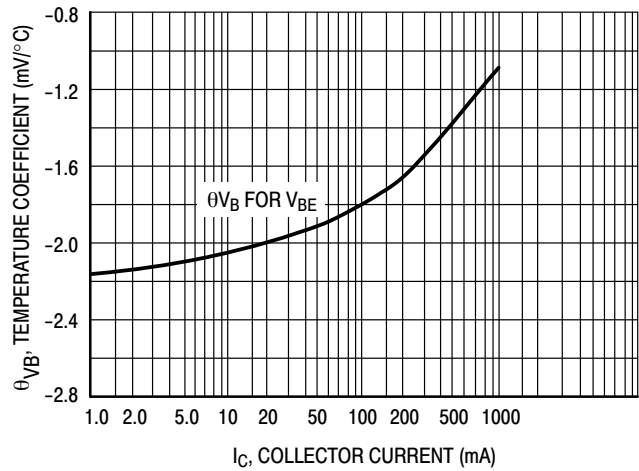

Figure 4. Temperature Coefficient

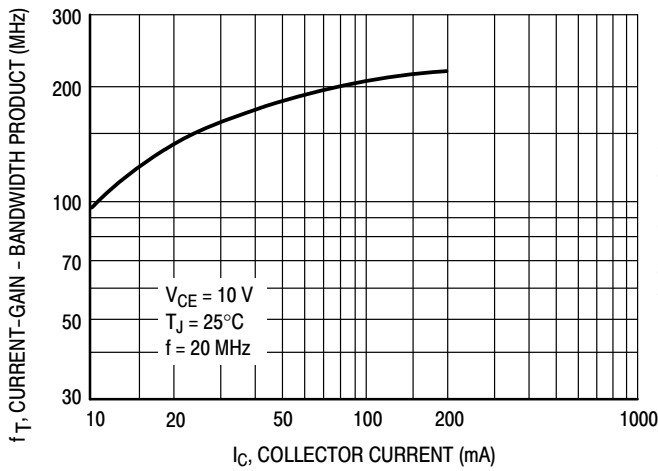

Figure 5. Current Gain — Bandwidth Product

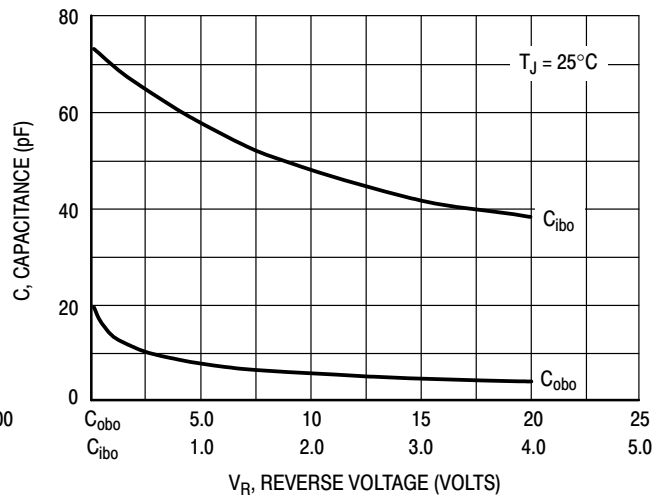

Figure 6. Capacitance

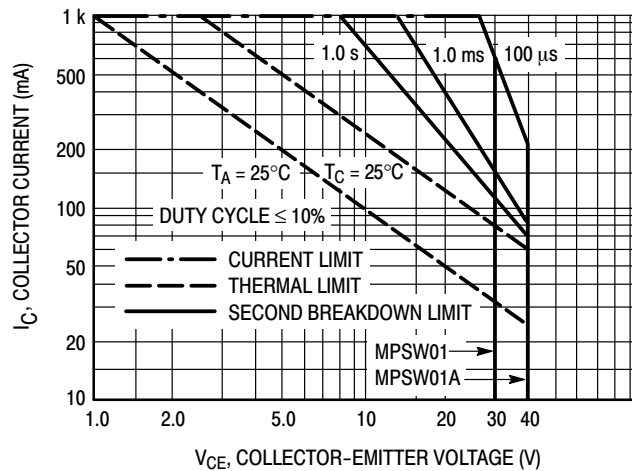
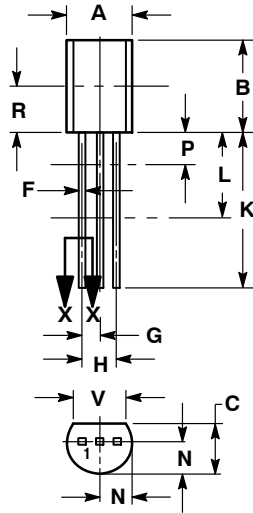

Figure 7. Active Region — Safe Operating Area

MPSW01, MPSW01A

PACKAGE DIMENSIONS

TO-92 (TO-226) 1 WATT
CASE 29-10
ISSUE O



STRAIGHT LEAD
BULK PACK

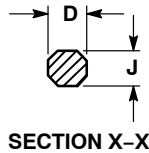

SECTION X-X

NOTES:

1. DIMENSIONING AND TOLERANCING PER ANSI Y14.5M, 1994.
2. CONTROLLING DIMENSION: INCHES.
3. CONTOUR OF PACKAGE BEYOND DIMENSION R IS UNCONTROLLED.
4. DIMENSION F APPLIES BETWEEN DIMENSIONS P AND L. DIMENSIONS D AND J APPLY BETWEEN DIMENSIONS L AND K MINIMUM. THE LEAD DIMENSIONS ARE UNCONTROLLED IN DIMENSION P AND BEYOND DIMENSION K MINIMUM.

DIM	INCHES		MILLIMETERS	
	MIN	MAX	MIN	MAX
A	0.175	0.205	4.44	5.21
B	0.290	0.310	7.37	7.87
C	0.125	0.165	3.18	4.19
D	0.018	0.021	0.46	0.53
F	0.016	0.019	0.41	0.48
G	0.045	0.055	1.15	1.39
H	0.095	0.105	2.42	2.66
J	0.018	0.024	0.46	0.61
K	0.500	---	12.70	---
L	0.250	---	6.35	---
N	0.080	0.105	2.04	2.66
P	---	0.100	---	2.54
R	0.135	---	3.43	---
V	0.135	---	3.43	---

- STYLE 1:
PIN 1. EMITTER
2. BASE
3. COLLECTOR

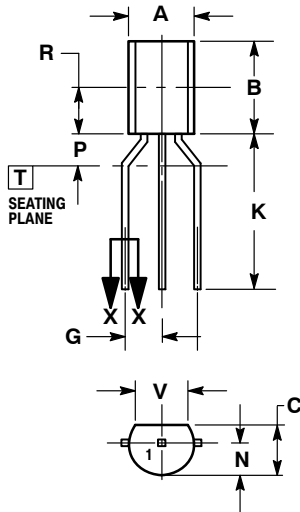

BENT LEAD
TAPE & REEL
AMMO PACK

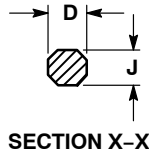

SECTION X-X

NOTES:

1. DIMENSIONING AND TOLERANCING PER ASME Y14.5M, 1994.
2. CONTROLLING DIMENSION: INCHES.
3. CONTOUR OF PACKAGE BEYOND DIMENSION R IS UNCONTROLLED.
4. DIMENSION F APPLIES BETWEEN DIMENSIONS P AND L. DIMENSIONS D AND J APPLY BETWEEN DIMENSIONS L AND K MINIMUM. THE LEAD DIMENSIONS ARE UNCONTROLLED IN DIMENSION P AND BEYOND DIMENSION K MINIMUM.

DIM	INCHES		MILLIMETERS	
	MIN	MAX	MIN	MAX
A	0.175	0.205	4.44	5.21
B	0.290	0.310	7.37	7.87
C	0.125	0.165	3.18	4.19
D	0.018	0.021	0.46	0.53
G	0.094	0.102	2.40	2.80
J	0.018	0.024	0.46	0.61
K	0.500	---	12.70	---
N	0.080	0.105	2.04	2.66
P	---	0.100	---	2.54
R	0.135	---	3.43	---
V	0.135	---	3.43	---

ON Semiconductor and are registered trademarks of Semiconductor Components Industries, LLC (SCILLC). SCILLC reserves the right to make changes without further notice to any products herein. SCILLC makes no warranty, representation or guarantee regarding the suitability of its products for any particular purpose, nor does SCILLC assume any liability arising out of the application or use of any product or circuit, and specifically disclaims any and all liability, including without limitation special, consequential or incidental damages. "Typical" parameters which may be provided in SCILLC data sheets and/or specifications can and do vary in different applications and actual performance may vary over time. All operating parameters, including "Typicals" must be validated for each customer application by customer's technical experts. SCILLC does not convey any license under its patent rights nor the rights of others. SCILLC products are not designed, intended, or authorized for use as components in systems intended for surgical implant into the body, or other applications intended to support or sustain life, or for any other application in which the failure of the SCILLC product could create a situation where personal injury or death may occur. Should Buyer purchase or use SCILLC products for any such unintended or unauthorized application, Buyer shall indemnify and hold SCILLC and its officers, employees, subsidiaries, affiliates, and distributors harmless against all claims, costs, damages, and expenses, and reasonable attorney fees arising out of, directly or indirectly, any claim of personal injury or death associated with such unintended or unauthorized use, even if such claim alleges that SCILLC was negligent regarding the design or manufacture of the part. SCILLC is an Equal Opportunity/Affirmative Action Employer. This literature is subject to all applicable copyright laws and is not for resale in any manner.

PUBLICATION ORDERING INFORMATION

LITERATURE FULFILLMENT:
Literature Distribution Center for ON Semiconductor
P.O. Box 5163, Denver, Colorado 80217 USA
Phone: 303-675-2175 or 800-344-3860 Toll Free USA/Canada
Fax: 303-675-2176 or 800-344-3867 Toll Free USA/Canada
Email: orderlit@onsemi.com

N. American Technical Support: 800-282-9855 Toll Free
USA/Canada
Europe, Middle East and Africa Technical Support:
Phone: 421 33 790 2910
Japan Customer Focus Center
Phone: 81-3-5773-3850

ON Semiconductor Website: www.onsemi.com
Order Literature: <http://www.onsemi.com/orderlit>
For additional information, please contact your local
Sales Representative