

User guide

**MAGNAVOX**  
SMART. VERY SMART.

## MRD-200 DVD HOME CINEMA SYSTEM



### **Read this first!**

Congratulations on purchasing this Magnavox product. We've included everything you need to get started. If you have any problems, Magnavox Representatives can help you get the most from your new product by explaining:

- Hookups,
- First Time Setup, and
- Feature Operation.

Do not attempt to return this product to the store.



**For fast help, call us first!**  
**1-800-705-2000**

Thank you for making Magnavox a part of your home!



# Return your Warranty Registration card today to ensure you receive all the benefits you're entitled to.

Once your MAGNAVOX purchase is registered, you're eligible to receive all the privileges of owning a MAGNAVOX product. So complete and return the Warranty Registration Card enclosed with your purchase at once. And take advantage of these important benefits.

## Warranty Verification

Registering your product within 10 days confirms your right to maximum protection under the terms and conditions of your MAGNAVOX warranty.

## Owner Confirmation

Your completed Warranty Registration Card serves as verification of ownership in the event of product theft or loss.

## Model Registration

Returning your Warranty Registration Card right away guarantees you'll receive all the information and special offers which you qualify for as the owner of your model.

# MAGNAVOX

**Congratulations on your purchase, and welcome to the "family!"**



### Dear MAGNAVOX product owner:

Thank you for your confidence in MAGNAVOX. You've selected one of the best-built, best-backed products available today. And we'll do everything in our power to keep you happy with your purchase for many years to come.

As a member of the MAGNAVOX "family," you're entitled to protection by one of the most comprehensive warranties and outstanding service networks in the industry.

What's more, your purchase guarantees you'll receive all the information and special offers for which you qualify, plus easy access to accessories from our convenient home shopping network.

And most importantly you can count on our uncompromising commitment to your total satisfaction.

All of this is our way of saying welcome-and thanks for investing in a MAGNAVOX product.

Lawrence J. Blanford  
President and Chief Executive Officer

**P.S. Remember, to get the most from your MAGNAVOX product, you must return your Warranty Registration Card within 10 days. So please mail it to us right now!**

Know these **safety** symbols



**⚡** This "bolt of lightning" indicates uninsulated material within your unit may cause an electrical shock. For the safety of everyone in your household, please do not remove product covering.

**⚠** The "exclamation point" calls attention to features for which you should read the enclosed literature closely to prevent operating and maintenance problems.

**WARNING:** TO PREVENT FIRE OR SHOCK HAZARD, DO NOT EXPOSE THIS EQUIPMENT TO RAIN OR MOISTURE.

**CAUTION:** To prevent electric shock, match wide blade of plug to wide slot, fully insert.

### For Customer Use

Enter below the Serial No. which is located on the rear of the cabinet. Retain this information for future reference.

Model No. \_\_\_\_\_  
Serial No. \_\_\_\_\_

Visit our World Wide Web Site at <http://www.magnavox.com>

# Table of Contents 3

## General Information

Table of Contents .....3  
Safety Information .....4

## Introduction .....5

## DVD Receiver Controls

Remote Control .....6  
Front Panel .....7  
Rear Panel .....8

## First Time Setup

First Time Setup .....9  
    Where Do You Start? .....9  
    Battery Installation .....9  
    Antenna Connections .....9  
Hookups - TV .....10-12  
Hookups - Speakers .....13  
Hookups - Optional .....14  
Hookups - VCR, Cable/Satellite box .....15

## Disc Playback

Quick Disc Playback .....16  
Playback Features .....17  
System Menu .....18  
Subtitles, Audio Language .....19  
Slow Motion, Searching .....20  
Title/Chapter Selection, Time Search .....21  
Status, Zoom .....22  
Angle, Step .....23  
Playback Control, MP3 Features .....24  
Repeat, Repeat A-B .....25  
Favorite Track Selection .....26

## DVD Receiver System Menu Options

TV System (NTSC/PAL) .....27  
TV Shape .....28  
Screen Saver, Video Out .....29  
Digital Output, Night Mode .....30  
Speaker Settings .....31  
Language Settings .....32  
Parental Control Levels .....33  
Parental Control Password, Defaults .....34

## Audio and Surround Sound Options

Audio and Sound Features .....35  
Surround Sound Options .....36  
Radio Stations .....37  
Sleep Timer .....38

## Additional Information

Helpful Hints .....39-40  
Specifications .....41  
Glossary .....42  
Index .....43  
Limited Warranty .....44

# 4 Safety Information

---

## IMPORTANT SAFETY INSTRUCTIONS.

1. Read these instructions.
  2. Keep these instructions.
  3. Heed all warnings.
  4. Follow all instructions.
  5. Do not use this apparatus near water.
  6. Clean only with dry cloth.
  7. Do not block any ventilation openings. Install in accordance with the manufacturer's instructions.
  8. Do not install near any heat sources such as radiators, heat registers, stoves, or other apparatus (including amplifiers) that produce heat.
  9. Do not defeat the safety purpose of the polarized or grounding-type plug. A polarized plug has two blades with one wider than the other. A grounding type plug has two blades and a third grounding prong. The wide blade or the third prong are provided for your safety. If the provided plug does not fit into your outlet, consult an electrician for replacement of the obsolete outlet.
  10. Protect the power cord from being walked on or pinched, particularly at plugs, convenience receptacles, and the point where they exit from the apparatus.
  11. Only use attachments/accessories specified by the manufacturer.
  12. Use only with the cart, stand, tripod, bracket, or table specified by the manufacturer or sold with the apparatus. When a cart is used, use caution when moving the cart/apparatus combination to avoid injury from tip-over.
- 
13. Unplug this apparatus during lightning storms or when unused for long periods of time.
  14. Refer all servicing to qualified service personnel. Servicing is required when the apparatus has been damaged in any way, such as power-supply cord or plug is damaged, liquid has been spilled or objects have fallen into the apparatus, the apparatus has been exposed to rain or moisture, does not operate normally, or has been dropped.
  15. Battery usage CAUTION - To prevent battery leakage that may result in bodily injury, property damage, or damage to the unit:
    - Install all batteries correctly, with + and - aligned as marked on the unit.
    - Do not mix batteries (old and new or carbon and alkaline, etc.).
    - Remove batteries when the unit is not used for a long time.

## Copyright Protection

This product incorporates copyright protection technology that is protected by method claims of certain U.S. patents and other intellectual property rights owned by Macrovision Corporation and other rights owners. Use of this copyright protection technology must be authorized by Macrovision Corporation, and is intended for home and other limited viewing uses only unless otherwise authorized by Macrovision Corporation. Reverse engineering or disassembly is prohibited.

## Federal Communications Commission (FCC)

The set complies with the FCC-Rules, Part 15 and with 21 CFR 1040.1. Operation is subject to the following two conditions:

1. This device may not cause harmful interference, and
2. This device must accept any interference received, including interference that may cause undesired operation.

## CAUTION

Use of controls or adjustments or performance of procedures other than herein may result in hazardous radiation exposure or other unsafe operation.

## ATTENTION

L'utilisation des commandes ou réglages ou le non-respect des procédures ci-incluses peuvent se traduire par une exposition dangereuse à l'irradiation.

## ATENCIÓN

El uso de mando o ajustes o la ejecución de métodos que no sean los aquí descritos puede ocasionar peligro de exposición a radiación.

## Important Information for Canada

This digital apparatus does not exceed the Class B limits for radio noise emissions from digital apparatus as set out in the Radio Interference Regulations of the Canadian Department of Communications.

Cet appareil numérique n'émet pas de bruits radioélectriques dépassant les limites applicables aux appareils numériques de Class B prescrites dans le Règlement sur le Brouillage Radioélectrique édicté par le Ministère des Communications du Canada.

## Installation

- Place the player on a flat, hard, and stable surface.
- There must be sufficient room in front of the DVD Receiver for the Disc drawer to open.
- For cabinet installations, allow about 10cm (4 inches) of free space all around the DVD Receiver for adequate ventilation.
- Do not expose your DVD Receiver to extreme temperatures or humidity.

**Class II equipment symbol**   
This symbol indicates that the unit has a double insulation system

## Welcome!

We hope you enjoy your complete DVD Home Cinema System. This seven-piece, 175-watt system creates dynamic sound quality and realism found only in cinemas. Features of the DVD Home Cinema System include:

- Surround Sound options
- Night Mode: Reduces the range between high and low volumes during Disc playback.
- Parental Controls: Sets a rating level so your children cannot watch a DVD that has a rating higher than the level you set.
- Sleep Timer: Turns the DVD Receiver to Standby Mode (Off) at a preset time.

## Package Contents

- Remote Control and two (2) AA batteries
- Audio and Video (Composite) cables
- Five speakers, including speaker wires
- Subwoofer, including connection cable and power cable
- AM loop antenna and FM wire antenna
- Owner's manual, Quick-Use Guide and product registration materials

## Environmental Information

All unnecessary packaging has been omitted. We have tried to make the packaging easy to separate into three materials: cardboard (box), polystyrene foam (buffer) and polyethylene (bags, protective foam sheet).

Your system consists of materials which can be recycled and reused if disassembled by a specialized company. Please observe the local regulations regarding the disposal of packaging materials, exhausted batteries and old equipment.

## Playable Discs

This DVD Home Cinema System will play:

- Digital Video Discs (DVDs)
- Video Compact Discs (VCDs) or Super Video CDs
- All finalized Audio CDs
- MP3 files on Compact Disc Recordable (CD-R) or Compact Disc Rewritable (CD-RW).



## Region Codes

DVDs must be labeled for **ALL** regions or for **Region 1** in order to play on the DVD Receiver of this Home Cinema System. You cannot play Discs that are labeled for other regions. The region code for the DVD Receiver is 1 (one). Look for the correct region symbol on your DVDs.

The number inside the globe refers to a region of the world. Region 1 represents the United States of America, Canada, upper regions of North America, Bermuda, the U.S. Virgin Islands, and small regions near Australia.



## Color Systems

Different color systems are available throughout the world. DVD makers record DVDs in a certain color system. The color system of the DVD may appear on the DVD or its case. The most common color systems are NTSC, PAL, and SECAM. NTSC is used primarily in the United States and North America.

This DVD Receiver is compatible with both NTSC and PAL. Follow the steps on page 26 to set the DVD Receiver to NTSC or PAL. Choose a setting that matches the color system of your TV and your DVDs.

## Maintenance and Cleaning

- Clean Discs with a cleaning cloth, wiping from the center to the edge in a straight line. Do not wipe the Disc in a circular motion.



- Do not use solvents such as benzine, thinner, commercially-available cleaners, or anti-static spray intended for analog discs.
- If the DVD Receiver cannot read Discs correctly, use an accessory cleaning CD/DVD to clean the lens. Other cleaning methods may destroy the lens. Always keep the tray closed to avoid dust on the lens.
- The lens may cloud over if you suddenly move the DVD Receiver from cold to warm room conditions. If lens clouding occurs, you may not be able to play a Disc. Leave the power on for about one hour with no Disc in the unit until playback is possible.
- Do not expose the receiver, batteries, or discs to humidity, rain, sand, or excessive heat (from devices or direct sunlight). Always keep the disc tray closed to avoid getting dust on the lens.

### Helpful Hint

- If you are having trouble playing a certain Disc, remove the Disc and try a different one. Improperly formatted Discs will not play on this DVD Receiver.

# 6 Remote Control

## MUTE Button

Press to turn off the sound. Press again to restore the sound to its previous level.

## Source Buttons

Press to select a sound source for the Receiver (TV/AV, DISC, TUNER or AUX).

## DISC MENU Button

Press to access or remove a DVD Disc Menu (remote must be in DISC mode). *Details are on page 15.*

## ◀◀ Button

In DISC mode, press to search backward during playback. Press repeatedly to return to a previous Chapter/Track or to the beginning of the current Chapter/Track. *Details are on page 16.*

In TUNER mode, press to tune to a radio station. *Details are on page 36.*

## ▼ ▲ ◀ ▶ Buttons

Press to move through a DVD Disc Menu or the DVD Receiver's System Menu.

When in the TUNER mode, use to select a preset radio station.

## STOP ■ Button

Press to stop Disc playback.

## VOL(ume) +/- Buttons

Press to increase or decrease the volume.

## SURROUND Button

Press to select a surround sound mode. *Details are on page 35.*

## SOUND Button

Press to select a sound effect: Concert, Drama, Action, Sci-Fi, Classic, Jazz, Rock, or Digital. *Details are on page 34.*

## REPEAT Button

Press to repeat playback of a Chapter, Track or Disc. *Details are on page 24.*

## REPEAT A-B Button

Press to repeat playback of a specific section on a Disc. *Details are on page 24.*

## SUBW +/- Buttons

Press to adjust the subwoofer's sound level.

## CENTER +/- Buttons

Press to adjust the center speaker's volume.

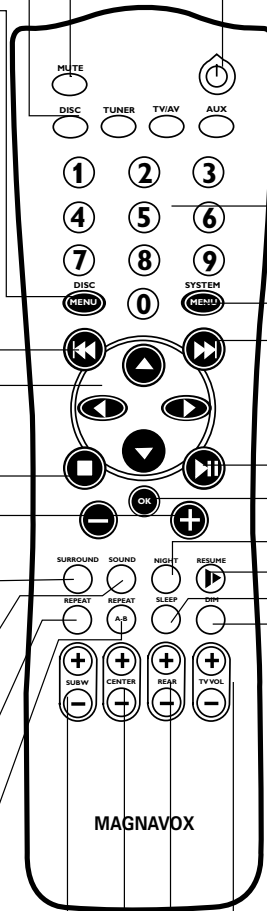

## Standby or Power ⏻ Button

Press to turn the DVD Receiver on or off (Standby).

## Number (0-9) Buttons

Press to enter a Track/Title number, radio station, or TV channel, depending on the mode of the remote.

## SYSTEM MENU Button

Press to enter or exit the System Menu (remote must be in DISC mode). *Details are on page 17.*

## ▶▶| Button

In DISC mode, press to go to the next Chapter or Track. Press and hold to search forward. *Details are on page 16.*

In TUNER Mode, press to tune to a radio station. *Details are on page 36.*

## PLAY/PAUSE ▶|| Button

Press to start or pause Disc playback.

## OK Button

Press to confirm menu selections.

## NIGHT Button

Press to reduce the range of volume between the loudest and softest sounds during DVD playback. *Details are on page 29.*

## RESUME ▶| Button

Press to continue playing a Disc after an interruption. *Details are on page 16.*

## SLEEP Button

Press to set the Sleep Timer. *Details are on page 37.*

## DIM Button

Press to select different levels of brightness for the DVD Receiver's display panel.

## TV VOL +/- Buttons

Press to adjust the TV volume if you have a Magnavox TV.

## REAR +/- Buttons

Press to adjust the rear surround speakers' volume.

# Front Panel 7

## STANDBY-ON (power) Button

Press to turn the DVD Receiver on or off (Standby).

## Disc Tray

Insert a Disc here. Load the Disc with the label facing up (shiny side facing down). If the Disc is two-sided, make sure the label for the side you want to play is facing up.

## PLAY/PAUSE Button

Press to play a Disc or to pause playback.

*Details are on pages 15-16.*

## STOP Button

Press to stop Disc playback.

## PROGRAM Button

In DISC mode, use to program Tracks. *Details are on page 25.*  
In TUNER mode, use to program preset radio stations.

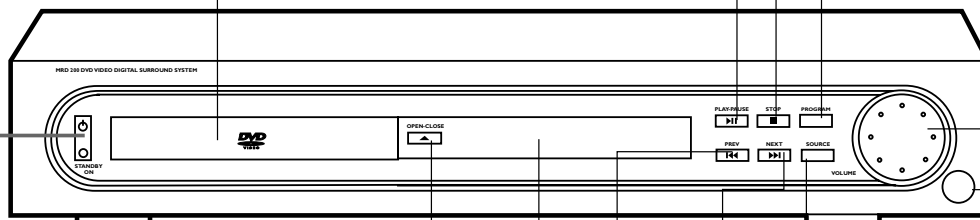

## OPEN/CLOSE Button

Press to open or close the Disc Tray.

## Display panel

Information about the current activity of the DVD Receiver appears here.

## PREV(ious) Button

In DISC mode, press to go to previous Chapters or Tracks or to the beginning of the current Chapter/Track. Press and hold for two seconds to start a reverse search during playback. *Details are on page 16.*

In TUNER mode, press to tune to a radio station. *Details are on page 36.*

## NEXT Button

In DISC mode, press to go to the next Chapter or Track. Press and hold for two seconds to search forward during playback. *Details are on page 16.*

In TUNER mode, press to tune to a radio station. *Details are on page 36.*

## SOURCE

Use to select a sound source (TV/AV, DISC, TUNER or AUX).

## (Headphones)

Connect headphones (not supplied) here.

## VOLUME

Use to adjust the volume and Bass/Treble levels.

## 8 Rear Panel

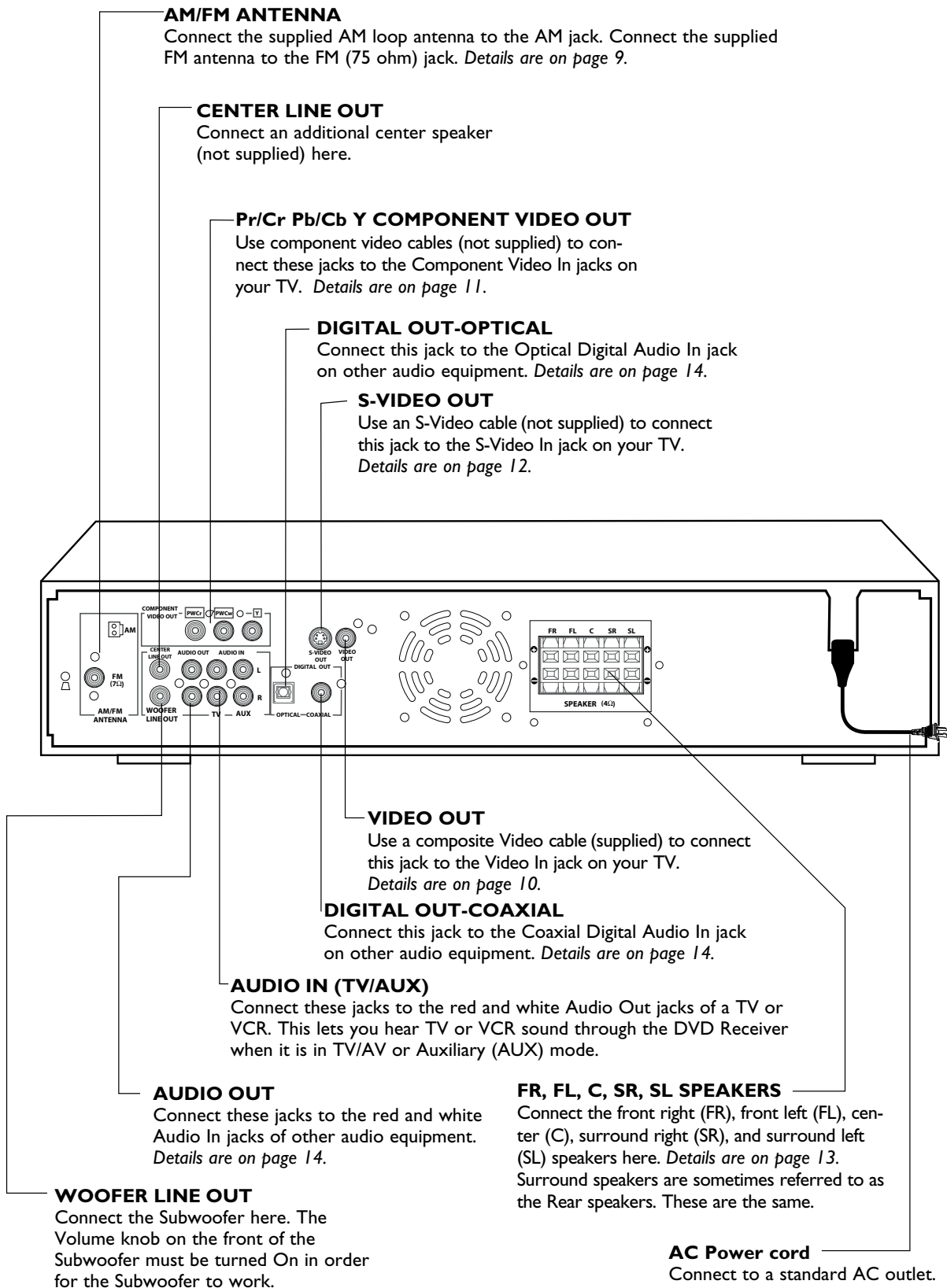



## Where Do You Start?

- 1** **Disconnect all equipment** from power. Connect equipment to power only after you have finished hooking up everything. Do not change connections with equipment connected to a power outlet.
- 2** **Put the batteries in the remote control and connect the AM and FM antennas as detailed below.**
- 3** **Connect the DVD Receiver to a Television using one of the options detailed in your separate Quick-Use Guide (or on pages 10-12).**
  - You need only one video connection between the DVD Receiver and the TV. Use Composite Video (good picture quality), S-Video (better picture), or Component Video (best picture). Use the best connection available with your TV.
  - Set the TV to the correct VIDEO IN channel. Such channels may be called AUX(iliary) IN, AUDIO/VIDEO (A/V) IN, EXT 1, S-VIDEO, etc. These channels are often near channel 00 on your TV. Or, your TV remote control may have a button or switch that chooses different Video modes. With some TVs, you use the TV's menu to select a Video mode. See your TV manual for details.
- 4** **Connect the speakers and Subwoofer to the DVD Receiver as detailed in your Quick-Use Guide (or on page 13).**

**Note:** If your TV only has a single Antenna In(put) jack, you will need an accessory RF Modulator to view the DVD playback on your TV. See your electronics retailer or contact Magnavox for details on RF Modulator availability.

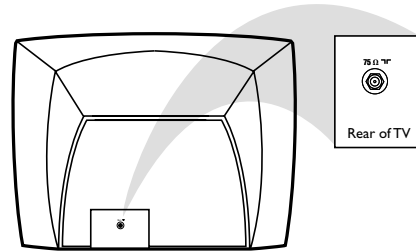

## Battery Installation

- 1** **Remove the battery compartment lid** by pressing in the tab, then lifting off the lid.
- 2** **Place the batteries in the battery compartment**, matching the +/- markings on the batteries to the +/- markings inside the remote.
- 3** **Replace the battery compartment lid.**

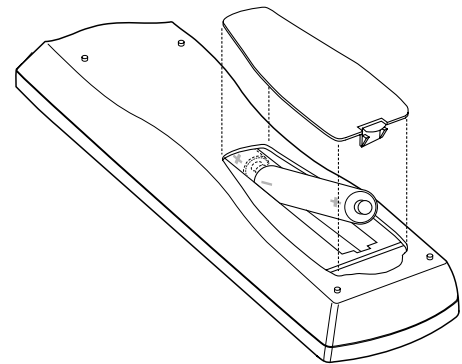

## Antenna Connections

- 1** **Connect the supplied AM loop antenna to the AM jack on the rear of the DVD Receiver.**
  - Reposition the loop antenna to receive the clearest sound for area stations. Attach the antenna to the base stand if desired.

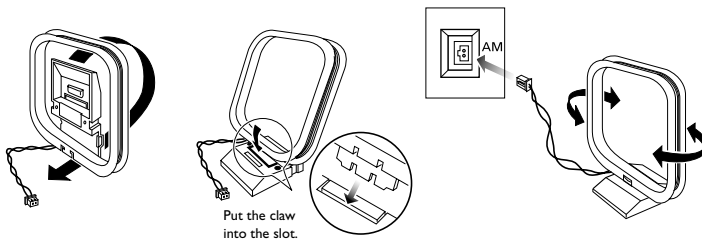

- 2** **Connect the supplied FM antenna to the FM jack on the rear of the DVD Receiver.** Extend and adjust the antenna until the clearest station signal is received. For better FM reception, use a 75 ohm coaxial cable (not supplied) to connect the DVD Receiver to an outdoor FM antenna as shown.

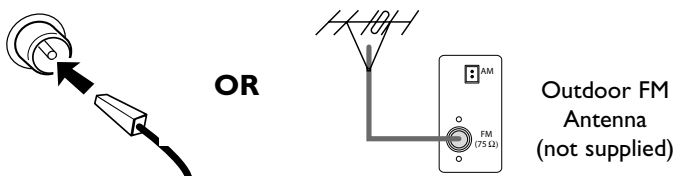

### Helpful Hint

- To prevent unwanted noise, keep the antenna as far away as possible from the TV, VCR, or any other radiation source.

## 10 Hookups - TV

---

### Connecting to a TV with a Composite (yellow) Video In Jack

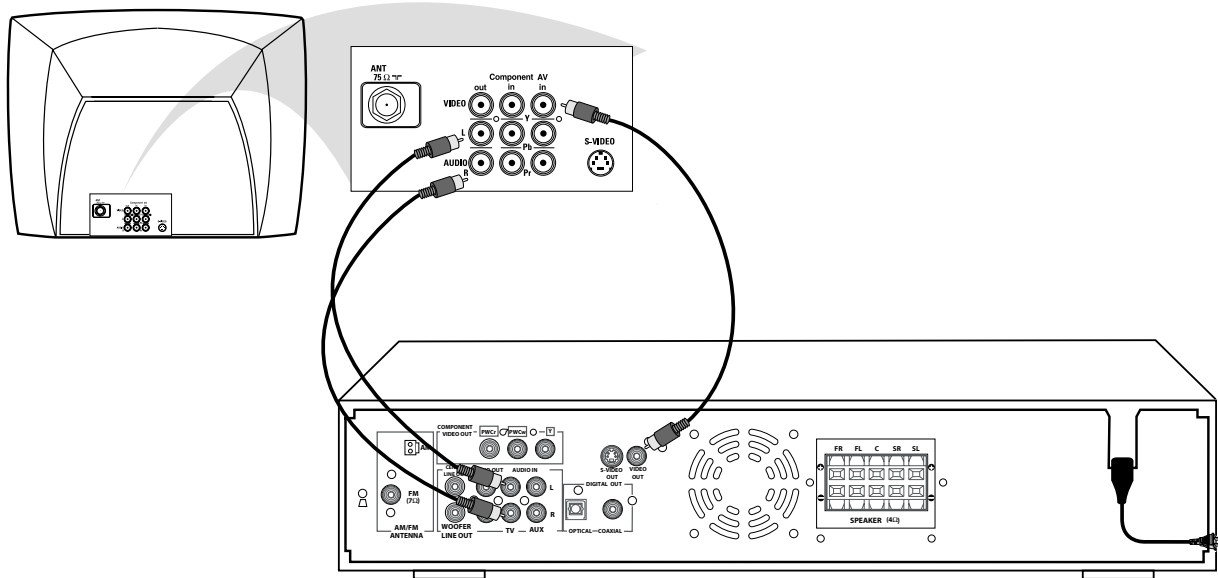

- 1** Connect the DVD Receiver's yellow VIDEO OUT jack to the VIDEO IN jack on your TV. Use the supplied composite (yellow) RCA-style video cable.
- 2** To hear TV channels through the DVD Home Cinema System, connect the supplied red and white audio cables to the DVD Receiver's red/white, right/left (TV) AUDIO IN jacks and to the TV'S right/left AUDIO OUT jacks. Match the cable colors to the jack colors.
- 3** Connect the power cords of the DVD Receiver and TV to a power outlet.
- 4** Turn on the TV and set it to the correct Video In channel. Go to the lowest TV channel and change channels down until you find the Video In channel. (It is not channel 3 or 4 as it might be when using a VCR.) See your TV owner's manual for details.
- 5** Press **STANDBY-ON**  on the front of the DVD Receiver to turn on the DVD Receiver. The red Standby light will disappear.

## Connecting to a TV with Component Video In Jacks

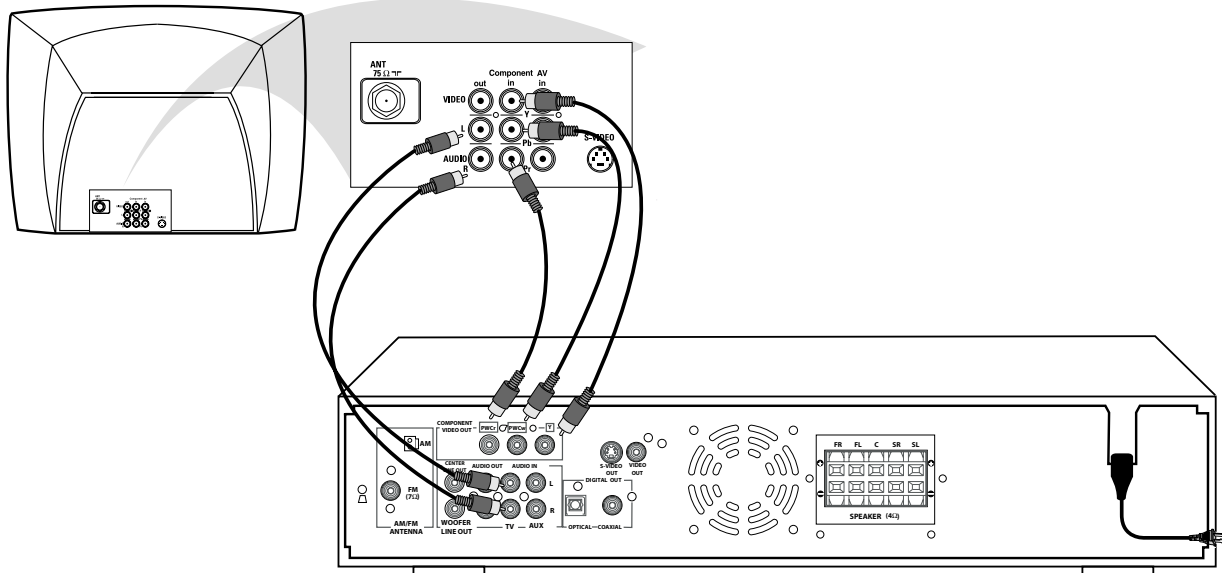

- 1** Connect the DVD Receiver's Pr/Cr Pb/Cb Y COMPONENT VIDEO OUT jacks to the matching Pr/Cr Pb/Cb Y VIDEO IN jacks on the TV. You will need a component video cable (Green-Y; Blue-Pb/Cb; Red- Pr/Cr) (not supplied). Match the cable colors to the jack colors.
- 2** To hear TV channels through the DVD Home Cinema System, connect the supplied red and white audio cables to the DVD Receiver's red/white, right/left (TV) AUDIO IN jacks and to the TV'S right/left AUDIO OUT jacks. Match the cable colors to the jack colors.
- 3** Connect the power cords of the DVD Receiver and TV to a power outlet.
- 4** Turn on the TV and set it to the correct Component Video In channel. Go to the lowest TV channel and change channels down until you find the Component Video In channel. (It is not channel 3 or 4 as it might be when using a VCR.) See your TV owner's manual for details.
- 5** Press **STANDBY-ON**  on the front of the DVD Receiver to turn on the DVD Receiver. The red Standby light will disappear.
- 6** Set **VIDEO OUT** to **PR PB Y**. Details are on page 28.





### Helpful Hint

- On the TV, the Component Video In jacks may be labeled YUV or Pr/Cr Pb/Cb Y and may be red, blue, and green.

## 12 Hookups - TV (cont'd)

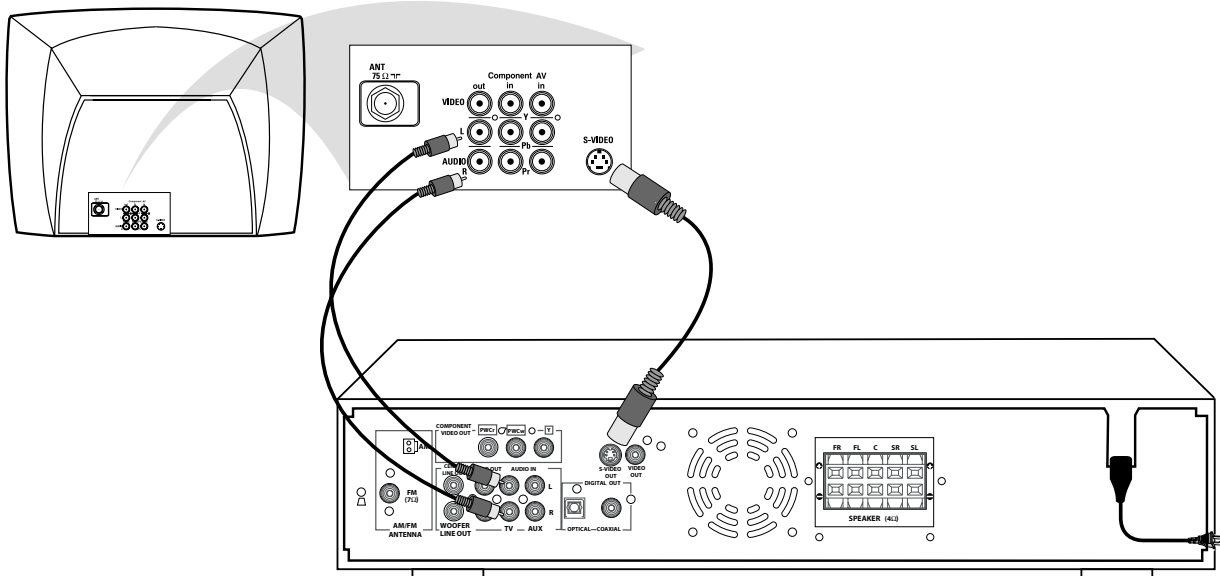
### Connecting to a TV with an S-Video In jack



- 1** Connect the DVD Receiver's **S-VIDEO OUT** jack to the **S-VIDEO IN** jack on your TV. You will need an S-Video cable (not supplied).
- 2** To hear TV channels through the DVD Home Cinema System, connect the supplied red and white audio cables to the DVD Receiver's red/white, right/left **AUDIO IN** jacks and to the TV'S right/left **AUDIO OUT** jacks. Match the cable colors to the jack colors.
- 3** Connect the power cords of the DVD Receiver and TV to a power outlet.
- 4** Turn on the TV and set it to the correct **S-Video In** channel. Go to the lowest TV channel and change channels down until you find the S-Video In channel. (It is not channel 3 or 4 as it might be when using a VCR.) See your TV owner's manual for details.
- 5** Press **STANDBY-ON**  on the front of the DVD Receiver to turn on the DVD Receiver. The red Standby light will disappear.
- 6** It is not necessary to set **VIDEO OUT** to **S-VIDEO**. S-VIDEO is the DVD Receiver's default setting. However, if your picture is distorted, check the VIDEO OUT setting. Make sure it is set to S-VIDEO. Details are on page 28.

## Connecting the Speakers

**Use the supplied speaker wires.**  
Match the color coded wiring. Connect the +/- terminals on the Receiver (FR, FL, etc.) to the correct +/- Speaker terminals.

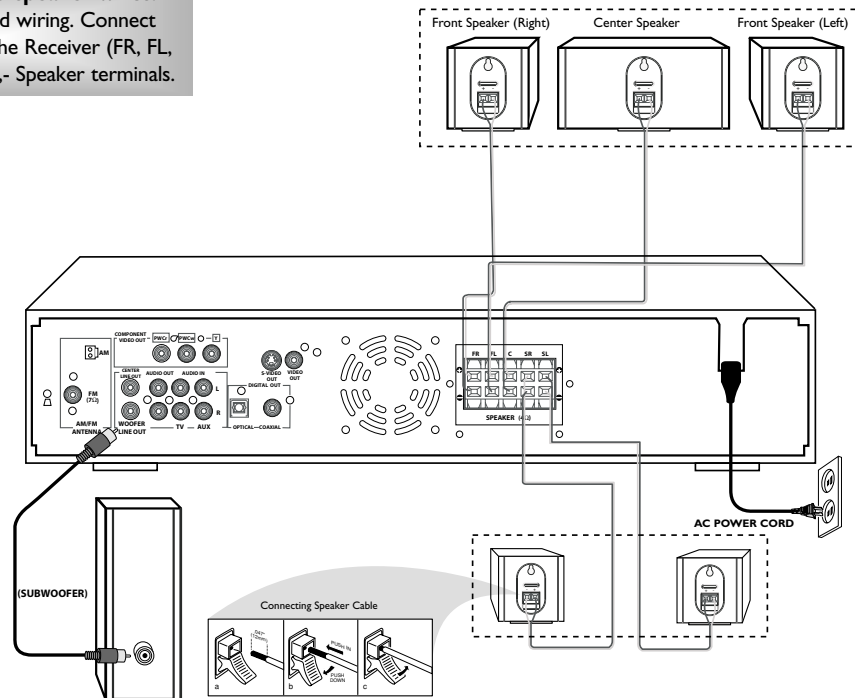

- 1** Connect the supplied **Front Right** speaker to the **Red/Black +/- FR (Front Right) SPEAKER** jacks on the rear of the DVD Receiver.
- 2** Connect the supplied **Front Left** speaker to the **White/Black +/- FL (Front Left) SPEAKER** jacks on the rear of the DVD Receiver.
- 3** Connect the supplied **Center** speaker to the **Green/Black +/- CENTER SPEAKER** jacks on the rear of the DVD Receiver.
- 4** Connect the supplied **Surround Right** speaker to the **Gray/Black +/- SR (Surround Right) SPEAKER** jacks on the rear of the DVD Receiver.
- 5** Connect the supplied **Surround Left** speaker to the **Blue/Black +/- SL (Surround Left) SPEAKER** jacks on the rear of the DVD Receiver.
- 6** Connect the supplied **Subwoofer** cable (with **RCA** plugs on either end) to the **WOOFER LINE OUT** jack on the DVD Receiver. Then connect the other end of the cable to the **AUDIO IN** jack on the Subwoofer.
  - Connect the **Subwoofer's** power cord to the Subwoofer and to a power outlet when connections are complete. Set the Subwoofer's Volume/On control to On.
  - Select the **phase polarity** ( $0^\circ$  or  $180^\circ$ ) at the rear of the subwoofer to determine the best bass reproduction effect for certain listening room conditions.
  - Press **SUBW +/-** buttons on the remote to adjust the volume level of the Subwoofer (-15dB to 10dB). SUB +XX DB" is shown in the DVD Receiver's Display panel.

# 14 Hookups - Optional

## Connecting to a TV and Optional Audio Equipment

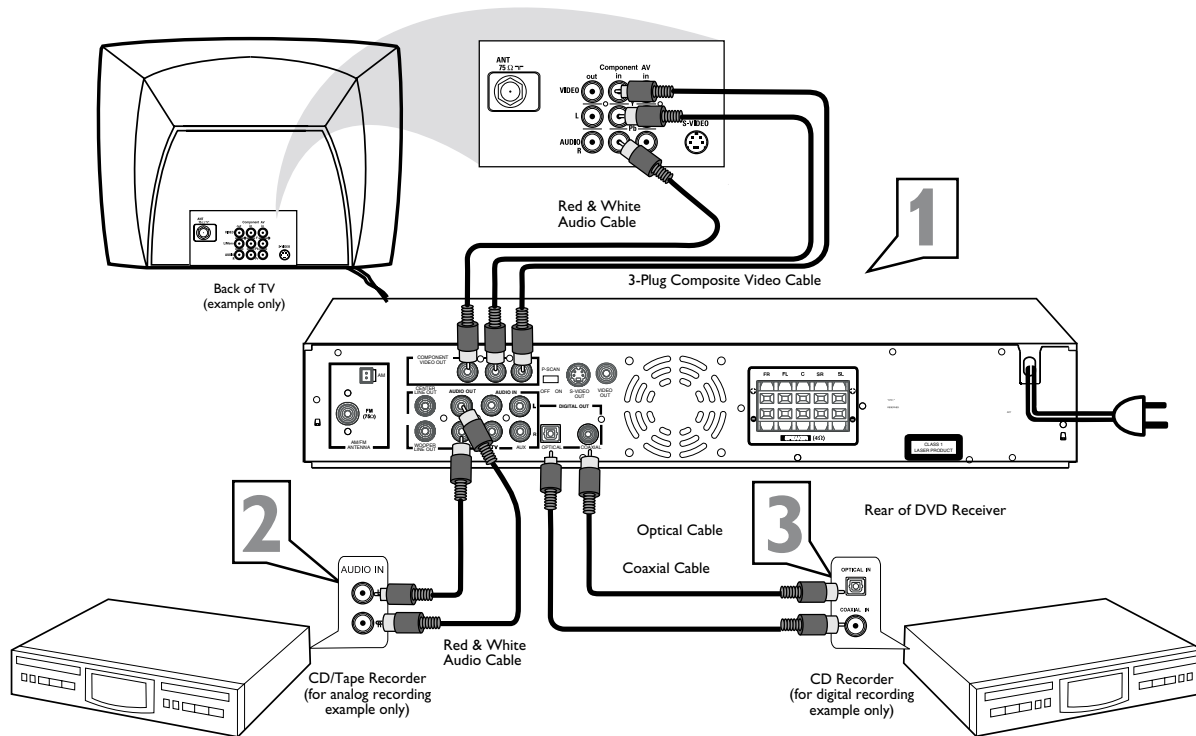

You must connect a TV to the DVD Receiver in order to view DVD playback. However, additional Home Cinema System connections are possible for recording or other sound features. Always refer to owner's manual of the other equipment for complete connection and use details.

- 1** Connect the DVD Receiver to a TV (as shown on pages 9-12 or in your separate Quick-Use Guide). Make only one video connection, whichever fits your TV.
- 2** Connect the DVD Receiver's AUDIO OUT jacks to the AUDIO IN jacks on an external audio accessory (CD Recorder, etc.) This will allow you to make analog Stereo (two channel, right and left) recordings.
- 3** Or, connect either of the DVD Receiver's DIGITAL OUT jacks - OPTICAL or COAXIAL - to a Stereo that is DTS (Digital Theater System) compatible, has a Dolby Digital decoder, or has CD recording capability.

### Helpful Hints

- If you used the DIGITAL OUT - OPTICAL or COAXIAL jacks, set DIGITAL OUTPUT to ALL on the DVD Receiver. Details are on page 29.
- Some DVDs are copy-protected. You cannot record or dub protected Discs using a VCR or a digital recording device.
- Digital recording is possible only on a CD or Video CD.
- MP3 audio is a digital recording option.

# Hookups - Optional 15

## Connecting to a VCR or Cable/Satellite Box

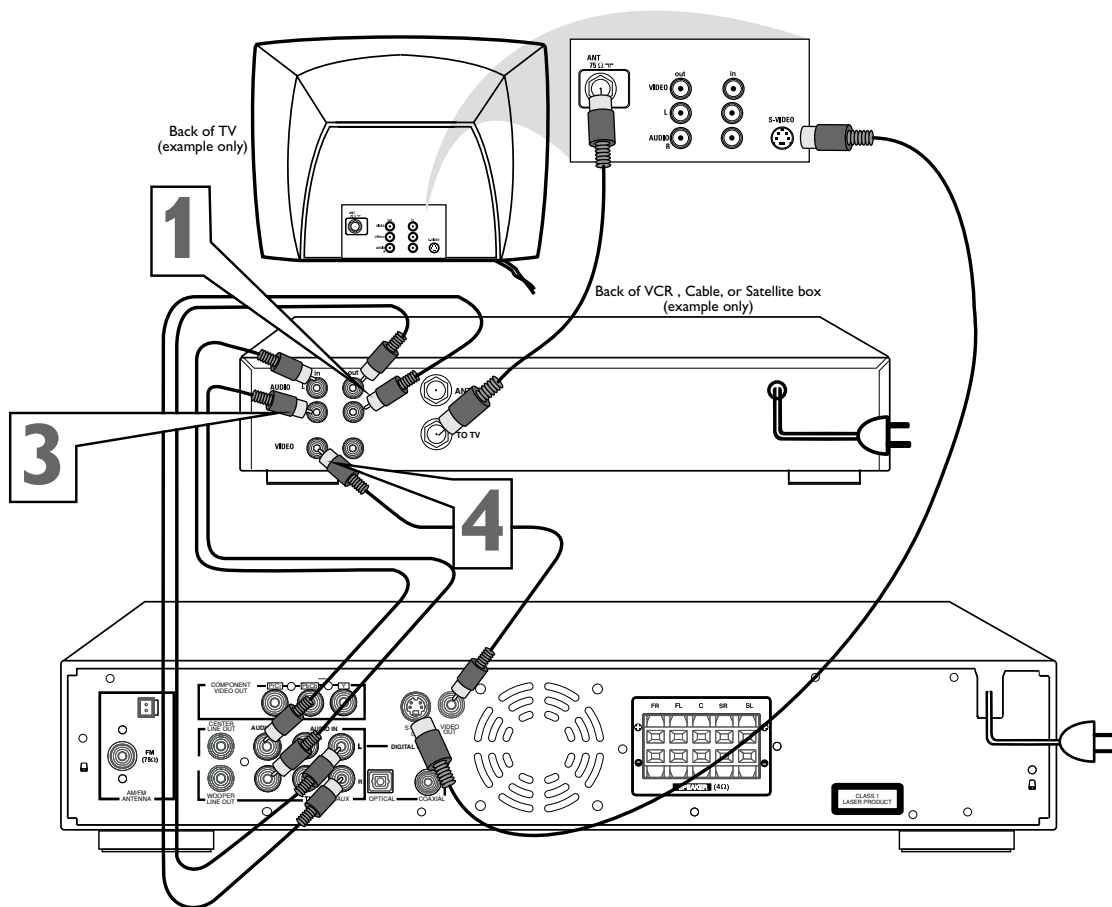

### Connecting a VCR or Cable/Satellite Box

You must connect the VCR or cable/satellite box to the TV to view VCR playback or cable/satellite channels. However, you can connect the VCR or cable/satellite box to the receiver in order to hear surround sound playback.

Always refer to owner's manual of the other equipment for complete connection and use details.

- 1** Connect the DVD Receiver's **AUDIO IN AUX L/R** jacks to the AUDIO OUT L/R jacks on the VCR or cable/satellite box.
- 2** Select **AUX** mode to listen to the VCR or cable/satellite playback on the surround sound speakers.

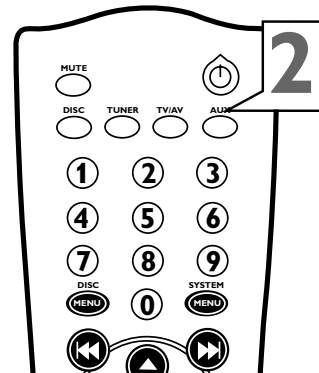

### Connecting a VCR for Recording DVDs

To view DVD playback while recording, you must connect the Receiver to your TV using a Component (Pr/Cr Pb/Cb Y) or S-Video connection.

See page 11-12 for details.

Some DVDs are copy-protected. You cannot record or dub protected Discs using a VCR.

- 3** Connect the DVD Receiver's **AUDIO OUT L/R** jacks to the AUDIO IN L/R jacks on the VCR.
- 4** Connect the DVD Receiver's **VIDEO OUT** jack to the VIDEO IN L/R jack on the VCR.

### Helpful Hints

- The receiver only uses all of the surround sound speakers when the incoming audio (from a VCR, cable, or satellite) is in surround sound format (Dolby Digital, DTS, Dolby Pro Logic). If the audio signal is in stereo format, some of the speakers will not be active.

# 16 Quick Disc Playback

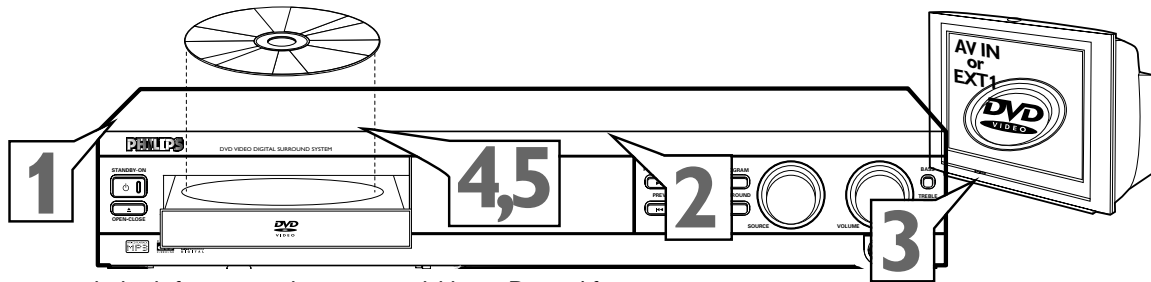

There are many playback features and options available on Discs. After learning the basic operations of the DVD Receiver and the remote control, refer to the later sections of this manual to learn playback features.

- 1** Press **STANDBY-ON** (or **DISC**) to turn on the DVD Receiver. The red Standby light will disappear from the front of the DVD Receiver.
- 2** Turn the **SOURCE** dial on the DVD Receiver (or press TV/AV, DISC, TUNER or AUX on the remote control) to select a sound source (or the equipment you want to hear).
  - The DVD Receiver's display panel will show the selected source (TV/AV, AUX, AM/FM, etc.).
  - Press DIM on the remote to adjust the brightness of the DVD Receiver's display panel.
- 3** Turn on your TV and set it to the correct Video In channel. You should see the DVD Receiver's background screen on the TV.
- 4** Press **OPEN/CLOSE** on the front of the DVD Receiver to open the Disc tray. Load your Disc in the tray, with the label facing up as you place the Disc in the tray.
  - If the Disc is two-sided, make sure the label of the side you want to play is facing up.
- 5** Press **OPEN/CLOSE** again to close the tray. Playback may begin automatically.
- 6** If playback does not start automatically, press **PLAY/PAUSE** .
  - If DVD playback does not start automatically, a DVD Disc Menu may appear.
  - If the Titles or Chapters are numbered, press a Number button to select an item. Or, press to select an item, then press OK.
- 7** To stop playback at any time, press **STOP** .
  - To continue Disc playback after an interruption, press **RESUME** before pressing **STOP** . (The last viewed scene will be kept in memory.) Press **RESUME** again to restart Disc playback at this point.
  - If you remove the Disc after pressing **STOP** , the Resume point will not remain in memory.

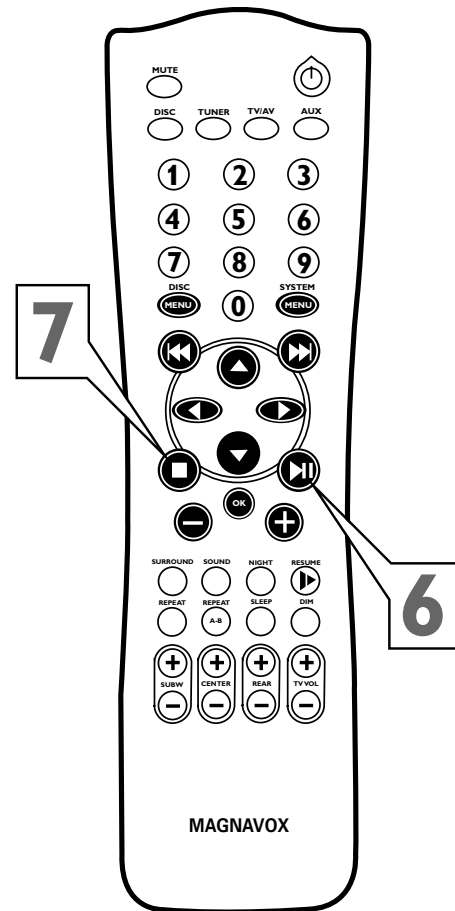

## DVD Disc Menus

DVD Disc Menus vary among DVDs. The DVD Disc Menus allow you to choose different playback features from those available on the Disc. If the DVD has a menu, access it by pressing DISC MENU on the remote control. If the current Title of the current DVD has a specific Title Menu, it may appear on the TV screen. Otherwise, the general DVD Disc Menu will appear.

Use to select a Title, Chapter, or other feature, then press **PLAY/PAUSE** or **OK** to start playing the Disc or to use a feature.



### Helpful Hints

- If the Disc is Locked by Parental Control, you must enter the four-digit code to unlock the Disc. Details are on pages 32-33.
- DVDs have a region code. Your DVD Receiver will not play Discs that have a region code other than 1 (one). Details are on page 5.
- Resume may not be available with some DVDs. Resume may apply to some Video CDs also.







# Playback Features 17



## Pausing Playback

- 1 Press **PLAY/PAUSE**  during playback to freeze the picture and mute the sound.
- 2 Press **PLAY/PAUSE**  to resume regular playback.



## Selecting Another Track/Chapter

- 1 Press  once during playback to go to the beginning of the current Track/Chapter. Press  multiple times to go to previous Tracks/Chapters.
- 2 Press  during playback to go to the beginning of the next Track/Chapter. Press  multiple times to go to subsequent Tracks/Chapters.

## Searching

- 1 Press and hold  or  for about two seconds to fast reverse or fast forward the Disc.
- 2 Press **PLAY/PAUSE**  to resume normal playback.

## Stopping and Resuming Playback

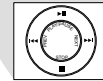
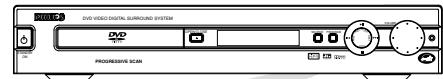

- 1 Press **STOP**  to stop Disc playback.
- 2 Press **RESUME**  to restart playback from the point at which it last stopped.

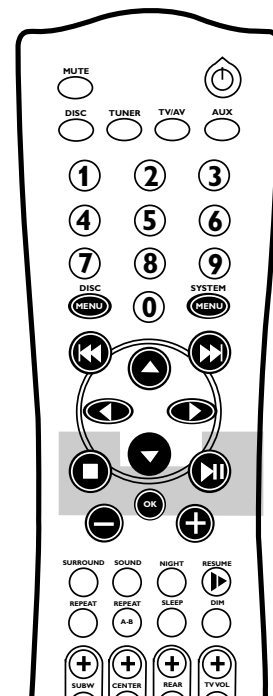

**Playback Buttons**  
Available on either the DVD Receiver or Remote Control.



## Helpful Hints

- During Repeat playback, pressing  or  will replay the same Track or Chapter.
- Opening the disc tray or turning off the DVD Receiver's power will cancel the Resume feature. Playback will restart at the beginning of the Disc as usual.
- Resume is not available on all Discs.

# 18 System Menu

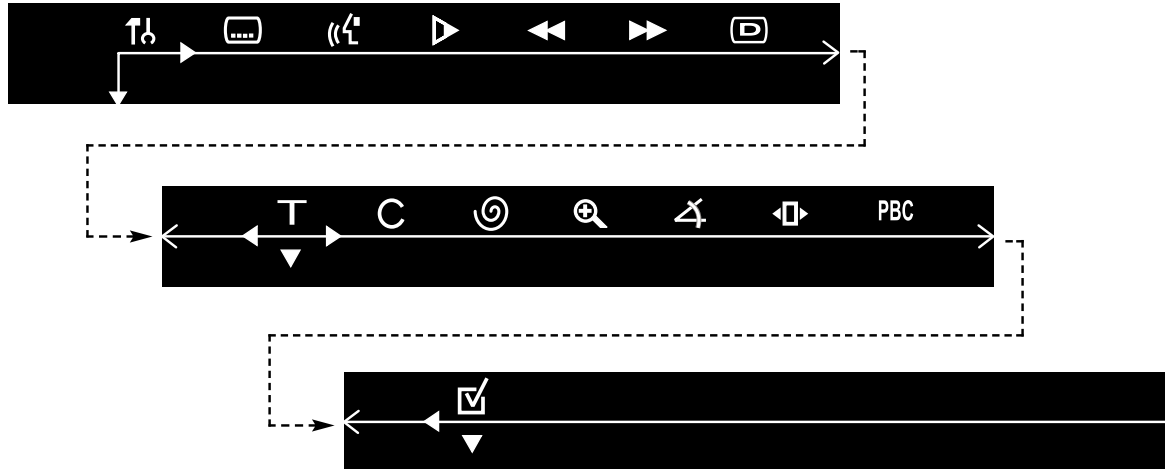

Use the System Menu to set up Disc features. Press SYSTEM MENU to access or remove the DVD Receiver's System Menu. Press ▼ ▲ ◀ ▶ and OK to choose a Menu item and change the settings. Even if a feature is set in the System Menu, it will not be available if the current Disc does not include that feature. *Details are on pages 18-22.*

- 1** Press **SYSTEM MENU**. The Menu Bar will appear across the top of the TV screen.
- 2** Press **◀** or **▶** to move through the Menu Bar.
- 3** Press **▼** to select the highlighted icon. Use **▼** or **▲** to select your desired option.
- 4** Press **OK** to confirm a selection.
- 5** To exit, press **SYSTEM MENU** or **OK**.

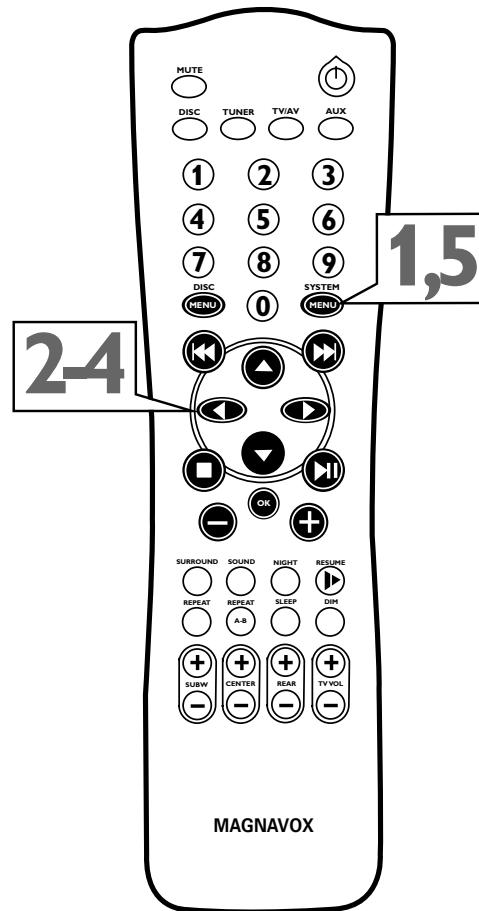

## System Menu Icons:

- Setup Menu** - User Preferences
- Subtitle** - Select Subtitle language if available
- Language** - Select multiple audio languages if available
- Slow** - Play DVD in slow motion
- Fast Reverse** - Play DVD backward in various speeds
- Fast Forward** - Play DVD forward in various speeds
- Status** - Check status of current Disc
- Title Search** - Choose different Titles if available
- Chapter Search** - Choose different Chapters if available
- Time Search** - Enter specific time for playback to begin
- Zoom** - Enlarge the DVD or Video CD image
- Angle** - Choose different Camera Angles during playback if available
- Step** - Select Frame-by-Frame (step-by-step) playback
- PBC** - Playback Control (Video CDs only)
- Program** - Select Favorite Track Selection

### Helpful Hints

- Features described in this manual may not be available on every Disc. If the feature is not on the Disc, you cannot use the DVD Receiver to make the feature available.
- When using the menu, a brief description of the selected feature appears at the bottom of the screen.

# Subtitles, Audio Language 19

## Subtitles

Some DVDs provide subtitles in multiple languages. If so, you can select a language in the Menu Bar. Check the DVD or its case to make sure subtitles are available in the language you want.

- 1 Press **SYSTEM MENU**.
- 2 Press ◀ or ▶ to select .
- 3 Press ▼ to select the language you want for the DVD's subtitles. The subtitle language default setting on the DVD Receiver is English.
- 4 Press **SYSTEM MENU** to remove the Menu Bar.

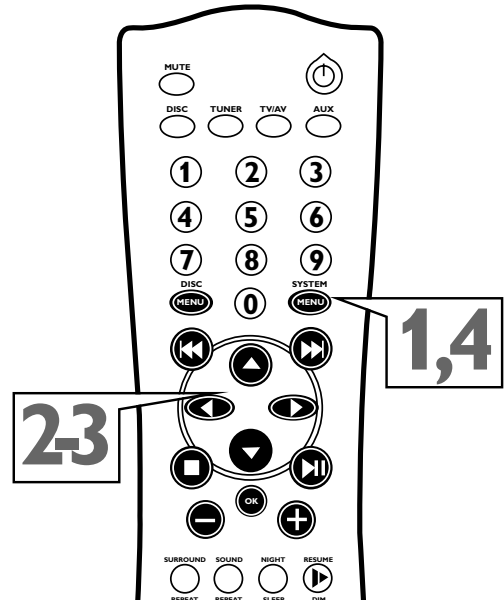

## Audio Language

Some DVDs are recorded in multiple languages; some may have extra audio options such as a director's commentary or a music soundtrack. Check the DVD or its case to determine whether different Audio options or languages are available.

- 1 Press **SYSTEM MENU**.
- 2 Press ◀ or ▶ to select .
- 3 Press ▼ to select the desired audio language. Or, during Video CD playback, press ▼ to select the audio channels you want to hear during playback. Options are LEFT VOCAL, RIGHT VOCAL, MONO LEFT, MONO RIGHT, or STEREO.
- 4 Press **SYSTEM MENU** to remove the Menu Bar.

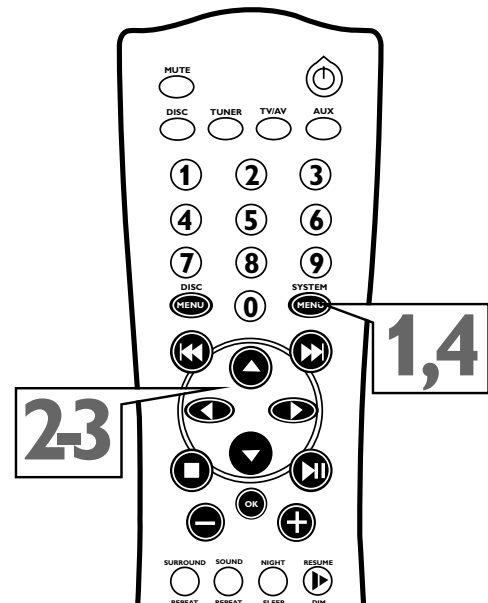

### Helpful Hints

- If a desired Audio or Subtitle language cannot be selected, the language is not available on the current Disc.
- Some DVDs only allow you to change the Audio or Subtitle language in the DVD Disc menu. Refer to the DVD's Disc menu for details on changing the Audio or Subtitle language.

## 20 Slow Motion, Searching

### Slow Motion



- 1 Press **SYSTEM MENU**.
- 2 Press ◀ or ▶ to select .
- 3 Press ▼ to select a **Slow Motion speed**.
  - During DVD playback, you may choose Slow Forward (SF) speeds of SF x2, SF x4, or SF x8; or, choose Slow Reverse (SR) speeds of SR x2, SR x4, or SR x8.
  - During Video CD playback, you can choose a Slow Forward speed of SF x1, SF x2, or SF x3. You cannot play Video CDs in Slow Reverse.
  - Choose SLOW OFF to resume normal playback.

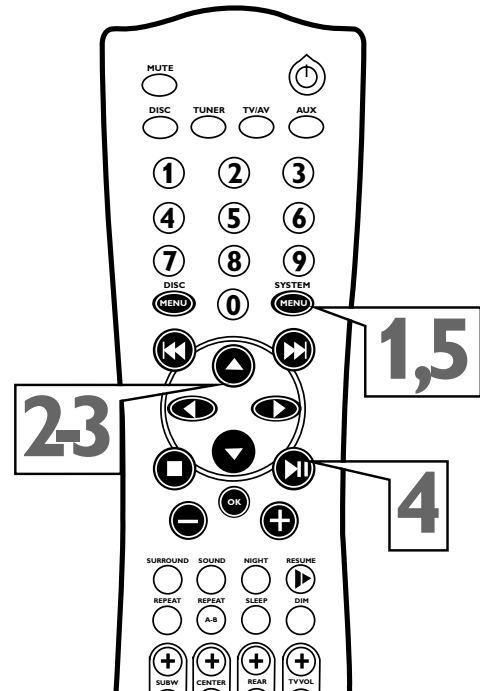

- 4 Press **PLAY/PAUSE**  to resume normal playback.
- 5 Press **SYSTEM MENU** to remove the Menu Bar.



### Searching

- 1 Press **SYSTEM MENU**.
- 2 Press ◀ or ▶ to select  or .
- 3 Press ▼ to select a search speed.
  - During DVD playback, you may choose Fast Reverse (FR) speeds of FR x2, FR x4, FR x6, or FR x8. Or, choose Fast Forward (FF) speeds of FF x2, FF x4, FF x6, or FF x8.
  - During Video CD playback, you may choose Fast Reverse speeds of FR x1, FR x2, FR x3, or FR x4. Or, choose Fast Forward speeds of FF x1, FF x2, FF x3, or FF x4.
  - Choose OFF to resume normal playback.



- 4 Press **PLAY/PAUSE**  to resume normal playback.
- 5 Press **SYSTEM MENU** to remove the Menu Bar.

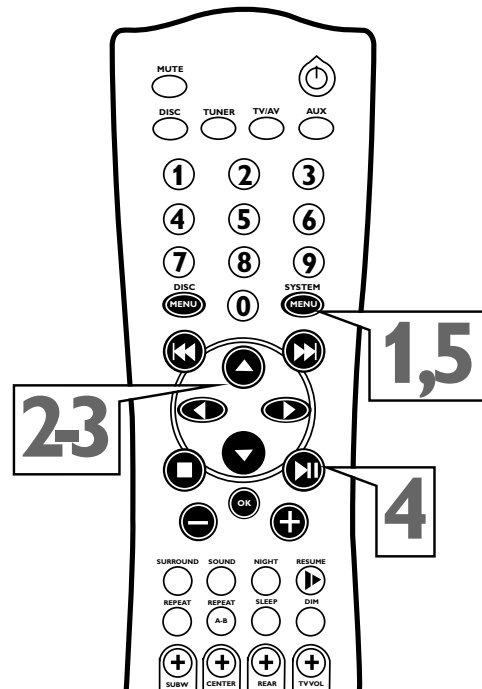



#### Helpful Hint

- Sound will be mute during Slow motion playback and Forward and Reverse Searching.

# Title/Chapter Selection, Time Search 21

## Title/Chapter Selection

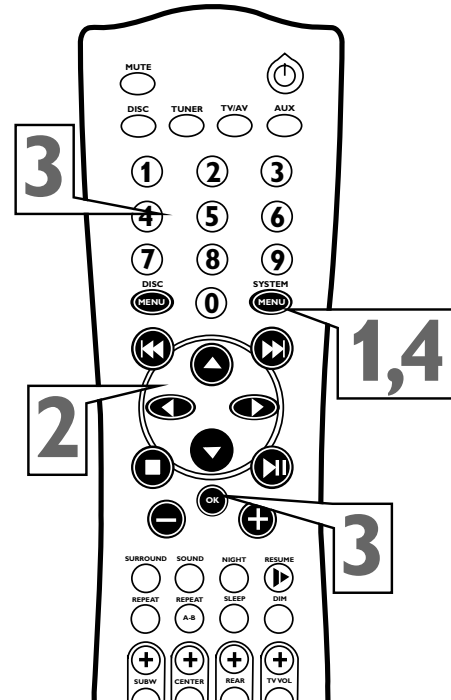

DVDs may contain multiple Titles or Chapters. To start playing a specific Chapter or Title directly, follow these steps.

- 1 Press **SYSTEM MENU**.
- 2 Press **◀** or **▶** to select **T** (Title) or **C** (Chapter).  
  
**TITLE 02/03**  
  
**CHAPTER 02/030**
- 3 Use the **Number buttons (0-9)** to select a Title or Chapter number, then press **OK**. The Title or Chapter you selected will start playing automatically.
- 4 Press **SYSTEM MENU** to remove the Menu Bar.



## Time Search

This allows you to start Disc playback at a specific elapsed playing time.

- 1 Press **SYSTEM MENU**.
- 2 Press **◀** or **▶** to select .
- 3 Press the **Number buttons (0-9)** to enter hours, minutes and seconds (from left to right) in the time edit box. As each number is entered, the next item will be highlighted.  

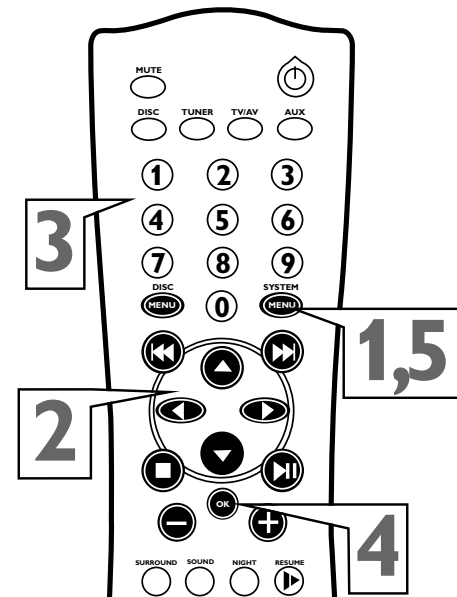
- 4 Press **OK** to start playback at the time you specified.
- 5 Press **SYSTEM MENU** to remove the Menu Bar.



### Helpful Hints

- Some DVDs may not allow you to choose a Title or Chapter in the DVD Receiver's Menu Bar. Choose the Chapter or Title you want in the DVD's Disc Menu instead.
- Time Search of a Video CD is not possible if Playback Control is active.

## 22 Status, Zoom

### Status

- 1 Press **SYSTEM MENU**.
- 2 Press **◀** or **▶** to select .
- 3 Press **▼** to see the status of the current Disc. Information may include the current Chapter or Title number, elapsed playing time, or remaining playing time. The information will vary according to the type of Disc that is in the DVD Receiver.

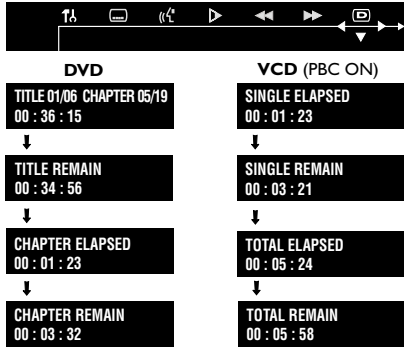

- 4 Press **SYSTEM MENU** to remove the Menu Bar.

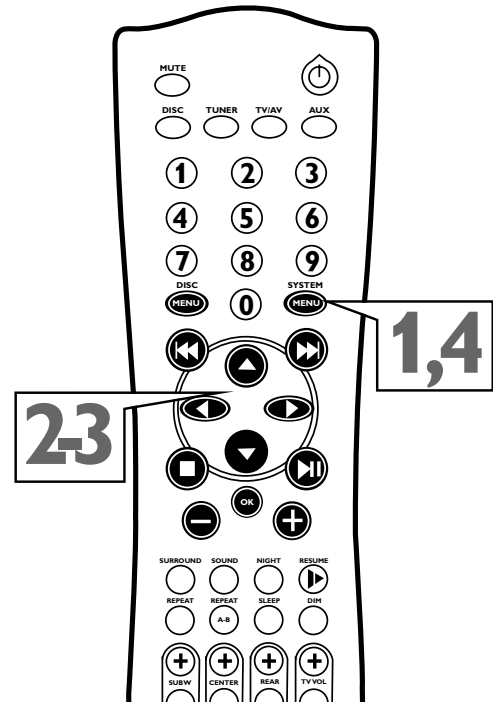

### Zoom

Zooming allows you to enlarge the DVD or Video CD image and scan through the picture.

- 1 Press **SYSTEM MENU**.
- 2 Press **◀** or **▶** to select .
- 3 Press **▼** repeatedly to select a zoom factor: **x1.5**, **x2.0**, **x4.0**, or **OFF**, then press **OK**. The picture will appear at 1.5, twice, or four times the normal size. Or, choose **OFF** to cancel zooming.



- 4 Press **▼ ▲ ◀ ▶** to move down, up, left, or right through the enlarged picture.
- 5 Press **SYSTEM MENU** to remove the Menu Bar.

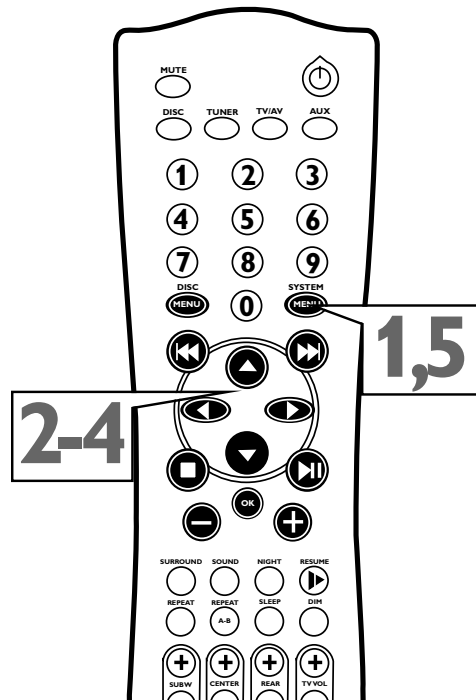

## Angle

Some DVDs contain scenes that were recorded at different angles or perspectives. Use the Angle feature in the Menu Bar to view DVD playback from a different angle.

Multiple angles must be available on the DVD. Check the DVD Disc Menu or the DVD case for details and availability of multiple angles.

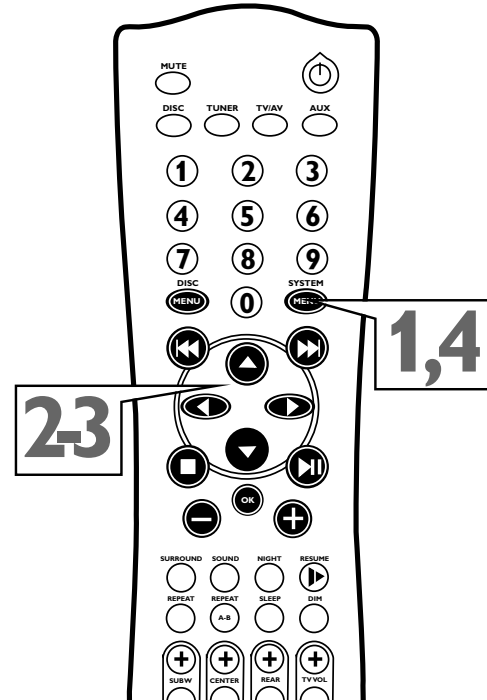

- 1 Press **SYSTEM MENU**.
- 2 Press **◀** or **▶** to select .
- 3 Press **▼** or **▲** to select an angle from those available. For example, if four different angles or perspectives are available, your choices would be: 1/4 (one of four available), 2/4, 3/4, or 4/4. The picture will change to the angle you selected automatically.



- 4 Press **SYSTEM MENU** to remove the Menu Bar.

## Step

Some DVDs and Video CDs will allow you to play the Disc one picture frame at a time. To do so, follow these steps.

- 1 Press **SYSTEM MENU**.
- 2 Press **◀** or **▶** to select .
- 3 Press **▼** to play the Disc one frame at a time.
 
- 4 Press **PLAY/PAUSE ▶||** to resume normal playback.
- 5 Press **SYSTEM MENU** to remove the Menu Bar.

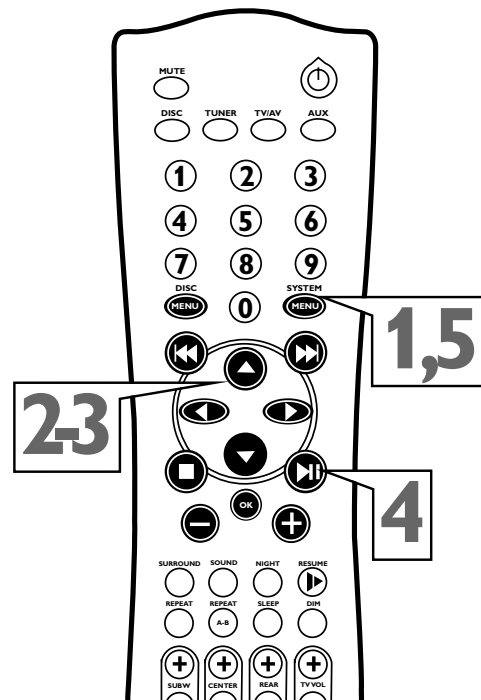

## 24 Playback Control, MP3 Features

### Playback Control (Video CD only)

Playback Control (PBC) is available on some Video CDs and provides interactive menus through which you can activate features or playback options. To access the PBC menus (only if available on the Video CD), follow these steps.

- 1 Press **SYSTEM MENU**.
- 2 Press **◀** or **▶** to select **PBC**.
- 3 Press **▼** to select **PBC ON** or **PBC OFF**.
  - Select PBC OFF and Video CDs will start playback automatically, without the Playback Control interactive menus.
  - Select PBC ON and the PBC menu (if available) will appear on the TV screen. Use the Number buttons (0-9) or follow the directions in the PBC menu to start playback or select features.



- 4 Press **SYSTEM MENU** to remove the Menu Bar.

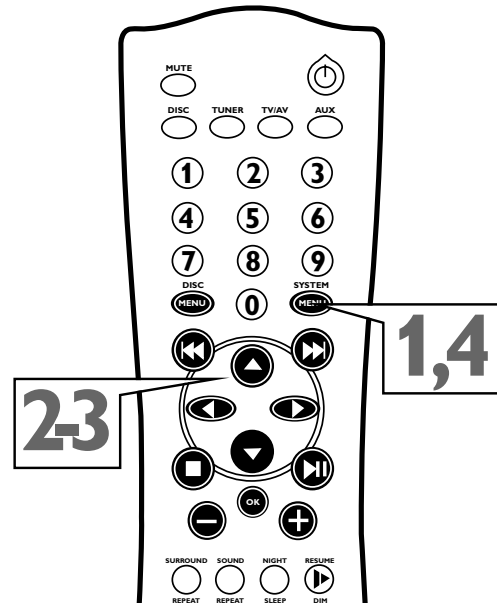

### MP3 Features

MP3 is a compression method that makes digital music files up to 10 times smaller without losing significant sound quality. MP3 is common on the Internet, letting you transfer Tracks to your computer and onto a CD Recordable or CD Rewritable.

The DVD Receiver supports these MP3 characteristics. Keep these in mind when you make Discs you plan to play on the DVD Receiver.

- Names of Albums, Artists, etc., with a maximum of 12 characters
- Maximum nested directory of seven levels
- Maximum of 32 Albums
- Sampling frequencies: 32 kHz, 44.1 kHz, 48 kHz
- Bit-rates (recording speeds): 32, 64, 96, 128, 192, and 256 kbps and supported VBR bit rate.

- 1 After you insert a Disc with MP3 files, press **DISC MENU**. The Album menu or list will appear on the TV screen. It may take the DVD Receiver up to 30 seconds to recognize the Disc due to the amount of songs on the Disc.
- 2 Press **▼ ▲ ◀ ▶** to select an Album or Track for playback. You also can use the Number buttons to select a Track directly.
- 3 Press **PLAY/PAUSE ▶||** or **OK** to confirm your selection and begin playback.
- 4 Or, if an MP3 menu or file list does not appear, you can play the currently selected Track or Album by pressing **PLAY/PAUSE ▶||**.
- 5 Press **◀◀** or **▶▶** to select the previous or next Track during playback. The current Track number will appear on the DVD Receiver's display panel.

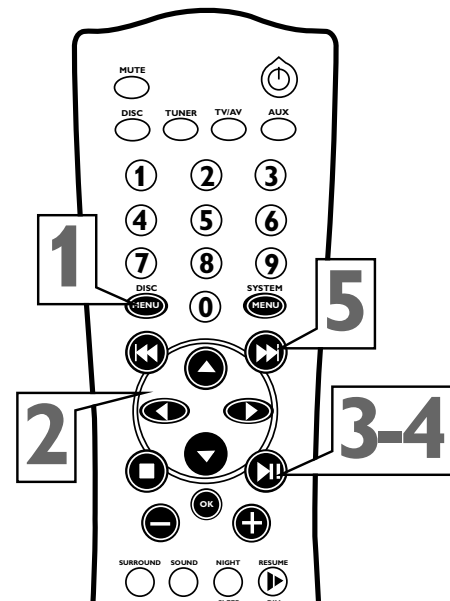

#### Helpful Hints

- Time Search and Repeat are not available when PBC is ON.
- You can only play, pause, or repeat MP3 files (Title, Album, or Disc).
- Albums may be referred to as Folders.
- You can play JPEG files on the DVD Receiver. For example, you may have film developed by a photographer who places the pictures on a CD-R for you. If the pictures are in JPEG format, view the images by playing the CD-R on the DVD Receiver.



# Repeat, Repeat A-B 25

## Repeat

- 1** During DVD playback, press **REPEAT** on the remote to play a Title or Chapter repeatedly. Press REPEAT to select:
  - CHAPTER REPEAT ON to repeat the current Chapter.
  - TITLE REPEAT ON to repeat the current Title.
  - REPEAT OFF to cancel repeat playback and resume normal play back.
- 2** During Video CD, Audio CD, or MP3 playback, press **REPEAT** to play a Track or Disc repeatedly. Press REPEAT to select:
  - "RPT ONE/R-I PLAY" to repeat the current Track.
  - "RPT-ALL/R-A PLAY" to repeat the entire Disc.

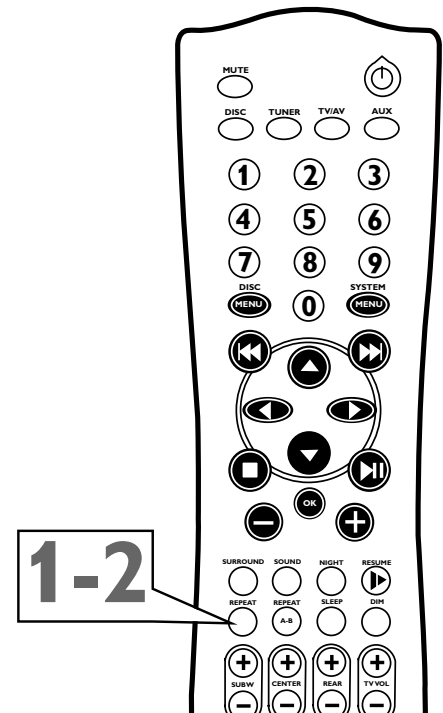

## Repeat A-B

You may set the DVD Receiver to play only a specific portion of a Chapter or Track repeatedly.

- 1** Press **PLAY/PAUSE** ►|| to start Disc playback.
- 2** When the Disc reaches the point at which you want repeated playback to begin, press **REPEAT A-B**.
- 3** When the Disc reaches the point at which you want to end the segment, press **REPEAT A-B** again. The segment will begin playing repeatedly.
  - On a DVD, make sure the entire A-B segment is within a single Chapter. On a Video CD or Audio CD, the A-B segment should be within a single Track.
- 4** To resume regular playback, press **REPEAT A-B** again. Regular playback will resume from the current point.

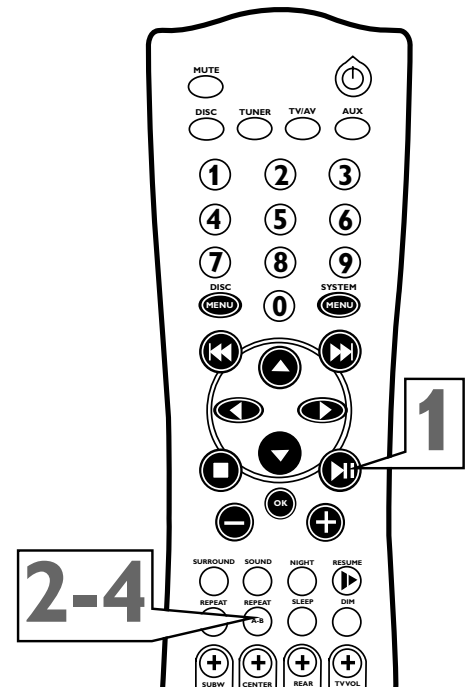

### Helpful Hints

- Repeat play is not possible during Video CD playback if Playback Control is active.
- Repeat play is not available with all Discs.

## 26 Favorite Track Selection

You can play Tracks in an order you specify, with up to 99 Tracks in a Program.

- 1** While playback is stopped, press **PROGRAM** on the DVD Receiver. "P 00:00" will appear on the DVD Receiver's display panel.
- 2** Press the **Number buttons** (0-9) to enter the Track number you want to play. If you try to program more than 99 tracks, "FULL" will show in the display panel.
- 3** Press **OK** to store the Track.
- 4** Repeat steps two and three until you program all the Tracks you want.
- 5** Press **PLAY/PAUSE** ►|| to play the Program.
- 6** Press **STOP** ■ once to stop playback. Press **STOP** ■ again to cancel the Program.

- You can access the Program in the Menu Bar as well. Press **SYSTEM MENU**, then press ► repeatedly to select . Press ▼, then use the Number buttons to enter the Tracks as described in step 2.

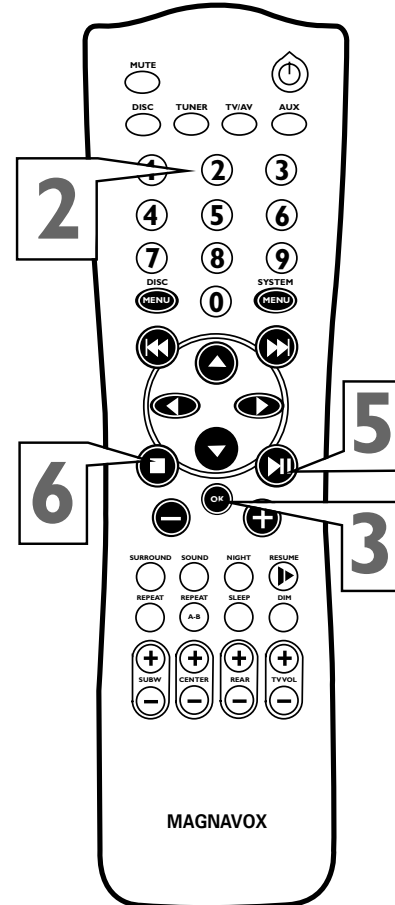
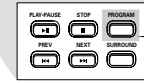



## TV System (NTSC, PAL) 27

DVDs are recorded according to a color system, the most common of which are NTSC and PAL. NTSC is the most common in the United States. Your TV also operates according to a color system.

The DVD Receiver is compatible with both NTSC and PAL. However, to play a DVD, the color system of the DVD, the TV, and the DVD Receiver should match. If all three are not the same, the DVD may play in only black and white, the picture may roll continuously, or the picture may appear distorted.

By adjusting TV System, you can set the DVD Receiver's color system to match that of your DVDs and your TV.

- 1** While playback is stopped, press **SYSTEM MENU**. Press ◀ or ▶ to select the  icon.
- 2** Press ▼ to select , then press ▶.
- 3** Press ▼ to select **TV SYSTEM**, then press ▶.
- 4** Press ▼ or ▲ to select **AUTO**, **NTSC**, or **PAL**, then press **OK**.
  - Select **AUTO** if you want the DVD Receiver to automatically select the color system of the current DVD. This is the default setting of the DVD Receiver.
  - Select **NTSC** if you plan to play NTSC DVDs and your TV is NTSC-compatible.
  - Select **PAL** if your DVDs are recorded in the PAL color system and your TV is PAL-compatible.

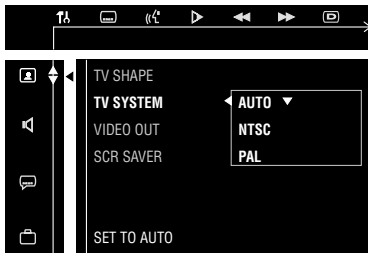

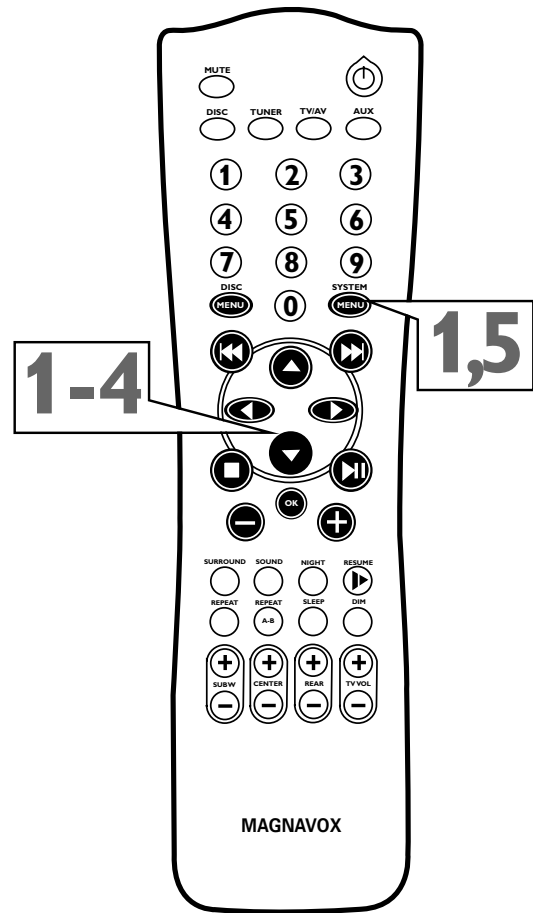

- 5** Press **SYSTEM MENU** to remove the menu.



## 28 TV Shape

You may set the DVD Receiver to display a DVD picture in one of three formats: Letterbox, Pan & Scan, or Wide. The format you select must be available on the DVD. To choose a format, follow these steps.

- 1** While playback is stopped, press **SYSTEM MENU**. Press ◀ or ▶ to select the  icon.
- 2** Press ▼ to select , then press ▶.
- 3** Press ▼ to select **TV SHAPE**, then press ▶.
- 4** Press ▼ or ▲ to select **4:3 PS (pan & scan)**, **4:3 LB (Letterbox)**, or **16:9 (Widescreen)**, then press **OK**.
  - Select 4:3 PS (pan & scan) if you want both sides of the picture to be trimmed (or formatted to fit your TV screen). This setting is possible only if the DVD is recorded in pan & scan or regular format. Check the Disc case for details.
  - Select 4:3 LB (letterbox) if you want to see the picture with black bars at the top and bottom of the screen. This looks like the picture you see when watching movies in a theater. This setting is possible only if the DVD was recorded in the letterbox or widescreen format. Check the Disc case for details.
  - Select 16:9 if you connected the DVD Receiver to a widescreen TV. Also remember to set the TV to its “full size” setting.

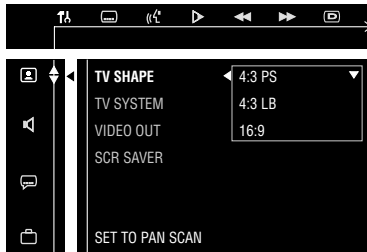

- 5** Press **SYSTEM MENU** to remove the menu.

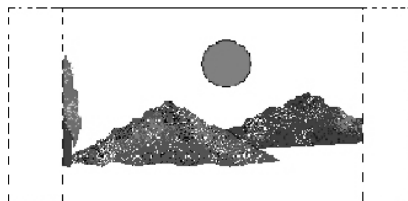
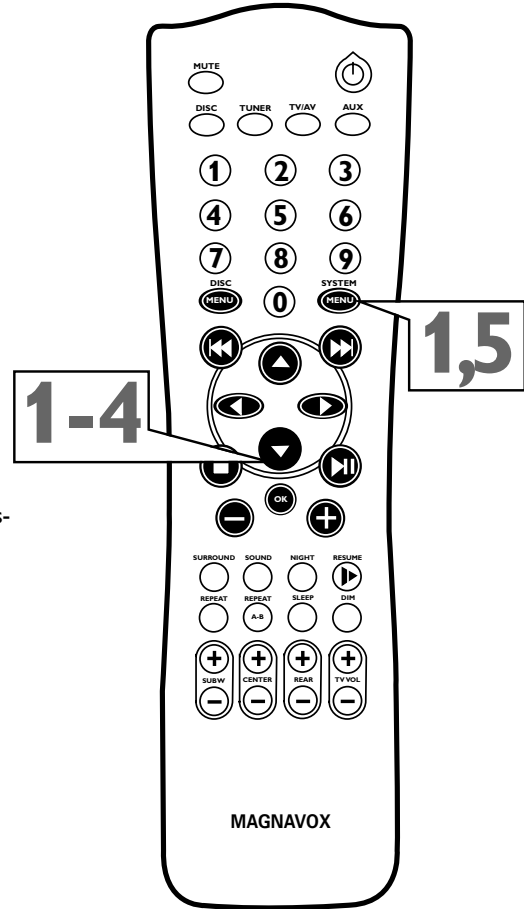

Pan & Scan

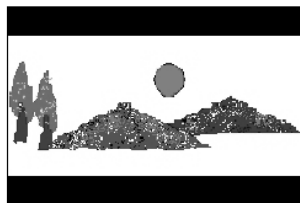

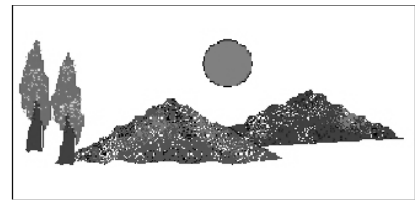

Letterbox



Widescreen (16:9)

## Screen Saver

The Screen Saver can appear if Disc playback is stopped or paused for more than one minute (and you do not use the DVD Receiver or its remote control). The Screen Saver is Off by default. To turn it On or Off, follow these steps.

- 1 While playback is stopped, press **SYSTEM MENU**. Press ◀ or ▶ to select the  icon.
- 2 Press ▼ to select , then press ▶.
- 3 Press ▼ to select **SCR SAVER**, then press ▶.
- 4 Press ▼ or ▲ to select **ON** or **OFF**, then press **OK**.

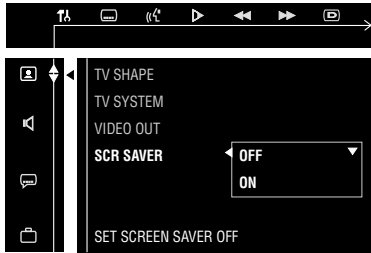

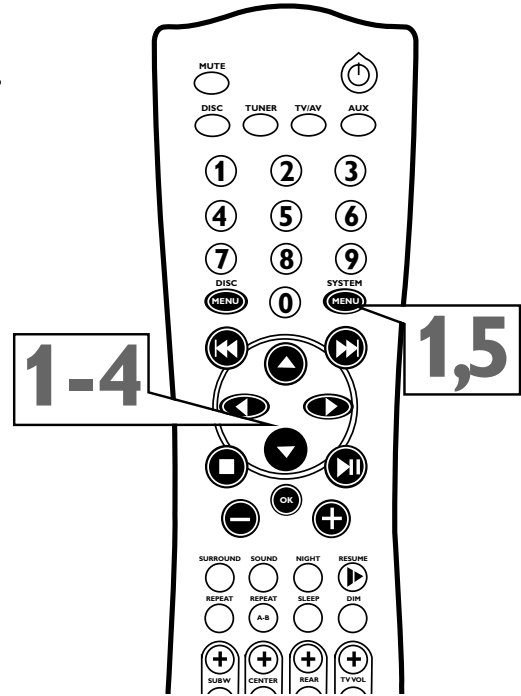

- 5 Press **SYSTEM MENU** to remove the menu.



## Video Out

If you used Component Video or S-Video connections as described on pages 11-12, set **VIDEO OUT** to **S-VIDEO** or **PR PB Y** (for Component Video) by following the steps below. **S-VIDEO** is the default setting.

- 1 While playback is stopped, press **SYSTEM MENU**. Press ◀ or ▶ to select the  icon.
- 2 Press ▼ to select , then press ▶.
- 3 Press ▼ to select **VIDEO OUT**, then press ▶.
- 4 Press ▼ or ▲ to select **S-VIDEO** or **PRPB Y**, then press **OK**.
  - Choose **S-VIDEO** if you connected the DVD Receiver's **S-VIDEO OUT** jack to the TV's **S-Video In** jack as described on page 12. **S-VIDEO** is the default setting of the DVD Receiver.
  - Choose **PR PB Y** if you connected the DVD Receiver's **Pr/Cr Pb/Cb Y COMPONENT VIDEO OUT** jacks to your TV's **Component Video In** jacks as described on page 11.
  - The **SCART** option is not available for this DVD Receiver.



- 5 Press **SYSTEM MENU** to remove the menu.

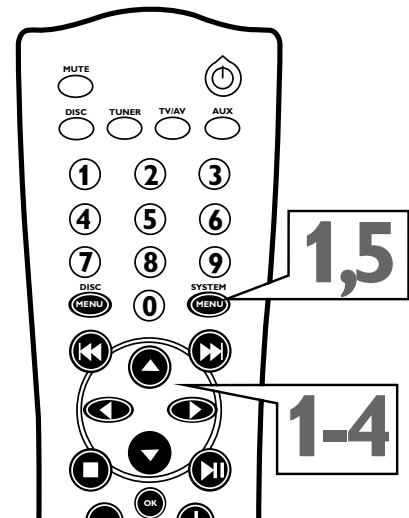



### Helpful Hints

- You only need one video connection between the TV and the DVD Receiver. You cannot use **S-Video** and **Component Video** at the same time.
- If you used the yellow **VIDEO OUT** jack on the DVD Receiver to connect it to the TV, you do not need to adjust the **VIDEO OUT** setting.

## 30 Digital Output, Night Mode

### Digital Output

Set Digital Output according to your audio connection.

- 1 While playback is stopped, press **SYSTEM MENU**. Press ◀ or ▶ to select the  icon.
- 2 Press ▼ repeatedly to select , then press ▶.
- 3 DIGITAL OUTPUT will be selected. Press ▶.
- 4 Press ▼ or ▲ to select **ALL**, **PCM 96K**, or **PCM 48K**, then press **OK**.
  - Choose ALL if you used the DIGITAL OUT - COAXIAL or OPTICAL jack on the DVD Receiver to connect to optional audio equipment.
  - Choose PCM 96K if you connected the DVD Receiver to optional audio equipment that is capable of processing sampling rates of 96 kHz.
  - Choose PCM 48K if you connected the DVD Receiver to optional audio equipment that cannot process sampling rates over 48K. Check the owner's manual of the optional audio equipment.

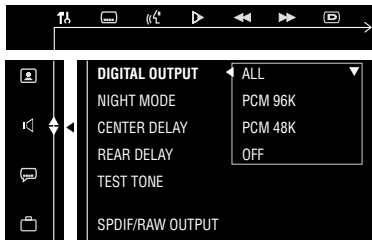

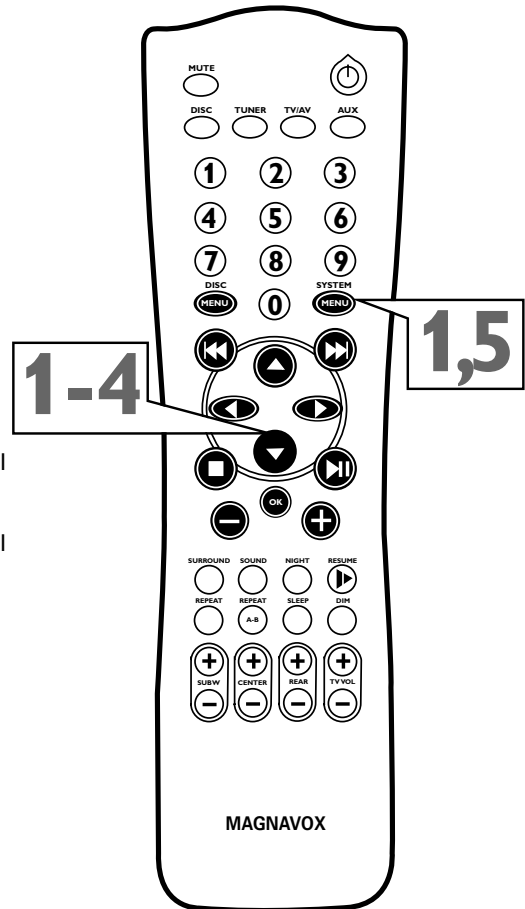

- 5 Press **SYSTEM MENU** to remove the menu.



### Night Mode

Set Night Mode to On to level the volume during Disc playback. This reduces the highs and lows of the volume.

- 1 While playback is stopped, press **SYSTEM MENU**. Press ◀ or ▶ to select the  icon.
- 2 Press ▼ repeatedly to select , then press ▶.
- 3 Press ▼ to select **NIGHT MODE**, then press ▶.
- 4 Press ▼ or ▲ to select **ON** or **OFF**, then press **OK**. OFF is the default setting.

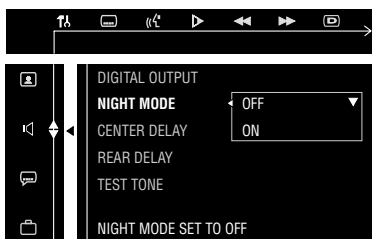

- 5 Press **SYSTEM MENU** to remove the menu.

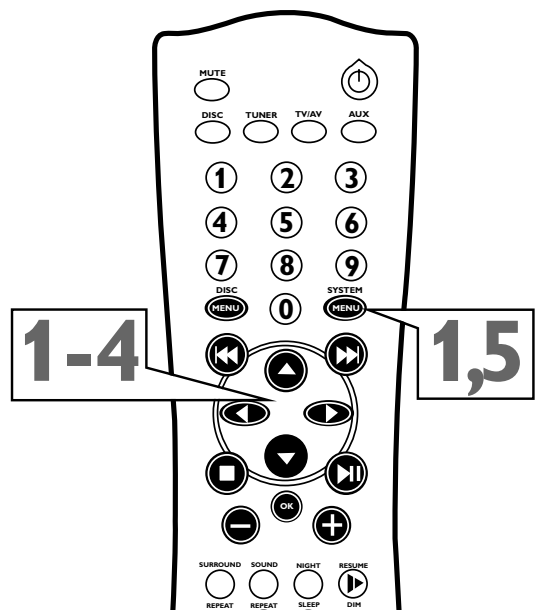



#### Helpful Hint

- You can activate Night Mode quickly by pressing **NIGHT** on the remote control.

# Speaker Settings 31

You can adjust the delay times and volume of the speakers connected to the DVD Receiver. These adjustments let you optimize the sound according to your surroundings and setup.

**1** While playback is stopped, press **SYSTEM MENU**. Press ◀ or ▶ to select the .

**2** Press ▼ repeatedly to select , then press ▶.

**3** Press ▼ to select **CENTER DELAY**, **REAR DELAY**, or **TEST TONE**, then press ▶.

- Choose **CENTER DELAY** if your listening position is closer to the Center speaker than the Front (Left & Right) speakers. Reset the Center speaker delay time (CENTER DELAY) to improve the Surround Sound effect. Choose 5MS (milliseconds), 3MS, 2MS, 1MS or OFF (default). Use the longer delay settings when the Center speaker is closer to the listener than the Front speakers.

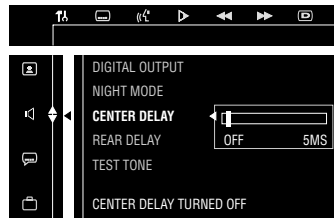

- Choose **REAR DELAY** if your listening position is closer to the Rear speakers than the Front (Left & Right) speakers. Reset the Rear speaker delay time (REAR DELAY) to improve the Surround Sound effect. Choose 15MS (milliseconds), 12MS, 9MS, 6MS (default) or OFF.

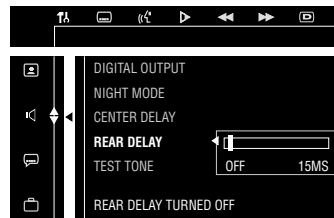

Use the longer delay settings when the Rear speakers are closer to the listener than the Front speakers.

- Choose **TEST TONE** if you want to test the volume levels of all the speakers in the DVD Home Cinema System. If you set TEST TONE to ON, the test sound signal will move through the Front Left, Center, Front Right, Surround Right, and Surround Left speakers. To stop the test sound signal, set TEST TONE to OFF. You must set TEST TONE to OFF before you can exit the System Menu and actually adjust the speakers' volume.

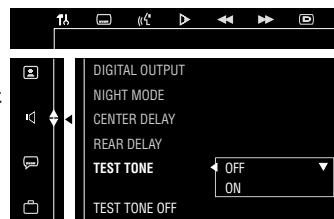

**4** Press ▼ or ▲ to adjust the item you selected as described in step 3.

**5** Press **SYSTEM MENU** to remove the menu.

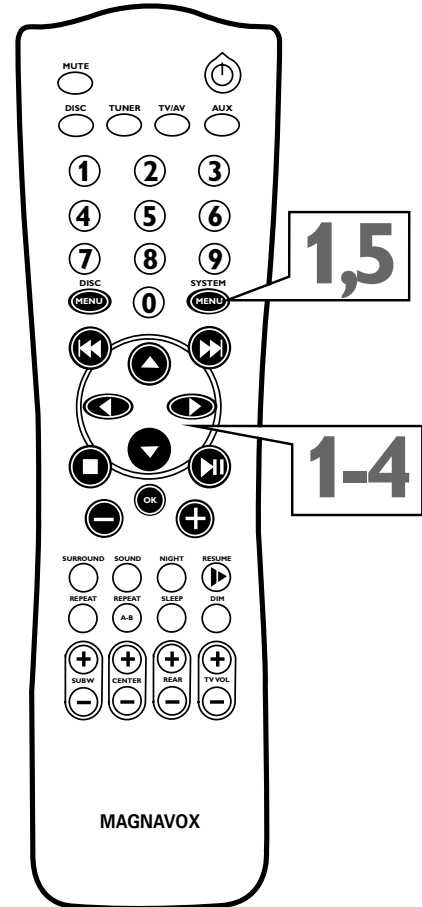



### Helpful Hint

- During Disc playback, press SUBW (+, -), REAR (+, -), or CENTER (+, -) to adjust the sound levels of the corresponding speakers.

## 32 Language Settings

### DVD Audio, Subtitle, and Disc Menu Languages

Some DVDs have multiple languages available for the Audio soundtrack, Subtitles, or the DVD Disc Menu. You may select different languages in the DVD Disc Menu or by following the steps below.

- 1** While playback is stopped, press **SYSTEM MENU**. Press ◀ or ▶ to select the  icon.
- 2** Press ▼ repeatedly to select , then press ▶.
- 3** Press ▼ or ▲ to select **AUDIO**, **SUBTITLE**, or **DISC MENU**, then press ▶.
- 4** Press ▼ or ▲ to choose the language you want. Press **OK**. Select a language that is available on the DVD. If you select a language that is not available on the DVD, the Disc's default setting will be used instead. Some DVDs only allow you to select a different language in the DVD Disc Menu. Check your DVD or its case for details.



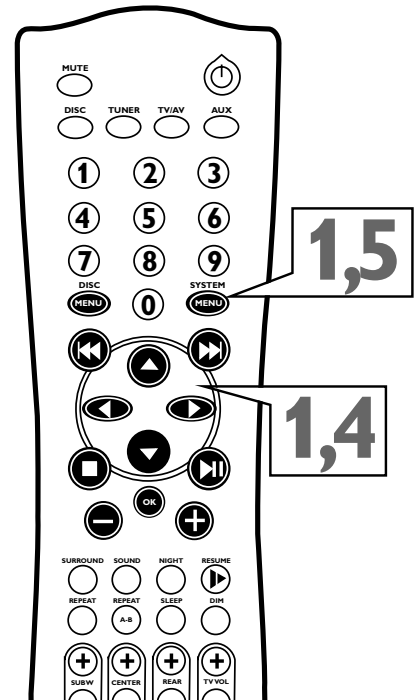

- 5** Press **SYSTEM MENU** to remove the menu.



### System Menu Language

The DVD Receiver's System Menu is available in English, German, French, Italian, Spanish, and Dutch. To select a different language for the DVD Receiver's System Menu, follow these steps. This does not affect the language of your DVD Disc Menus, DVD Subtitles, or DVD Audio. (See details above.)

- 1** While playback is stopped, press **SYSTEM MENU**. Press ◀ or ▶ to select the  icon.
- 2** Press ▼ repeatedly to select , then press ▶.
- 3** Press ▼ or ▲ to select **MENU LANG**, then press ▶.
- 4** Press ▼ or ▲ to choose the language you want. Press **OK**.

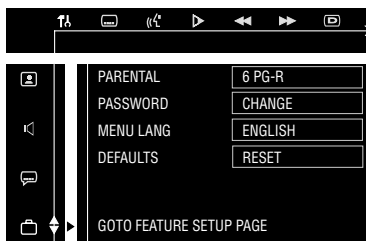

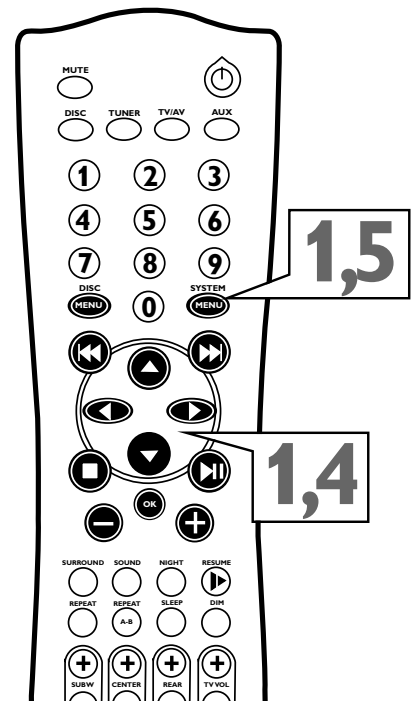

- 5** Press **SYSTEM MENU** to remove the menu.





# Parental Control Levels 33

Some DVD and Video CD makers code the DVD/Video CD so it will only play according to the level you set at the DVD Receiver. The Parental Control level may apply to the complete Disc or to certain scenes on the Disc. Follow the steps below to set the Parental Level at which you want Discs to play.

- 1** While playback is stopped, press **SYSTEM MENU**. Press **◀** or **▶** to select the  icon.
- 2** Press **▼** repeatedly to select , then press **▶**.
- 3** PARENTAL will be selected. Press **▶**.
- 4** Press the **Number buttons (0-9)** on the remote control to enter your four-digit code as requested. When doing this for the first time, enter any four numbers you prefer. You will have to enter the same code, exactly, twice. This will set your code for the first time. For password details, see page 33.

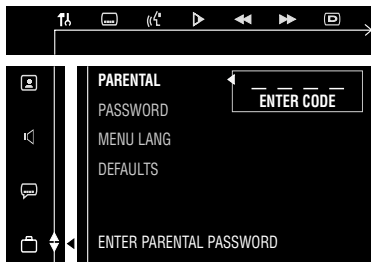

- 5** Press **▼** or **▲** to select a Parental Control Level, then press **OK**. DVDs that are rated above the level you selected will not play unless you enter your four-digit password and choose a higher level. To disable Parental Controls and have all Discs play, choose **NO PARENTAL**.

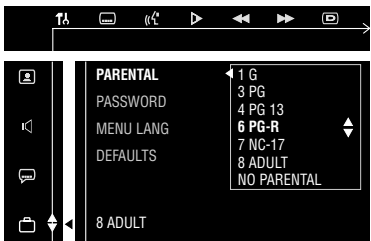

- 6** Press **SYSTEM MENU** or **OK** to remove the menu.

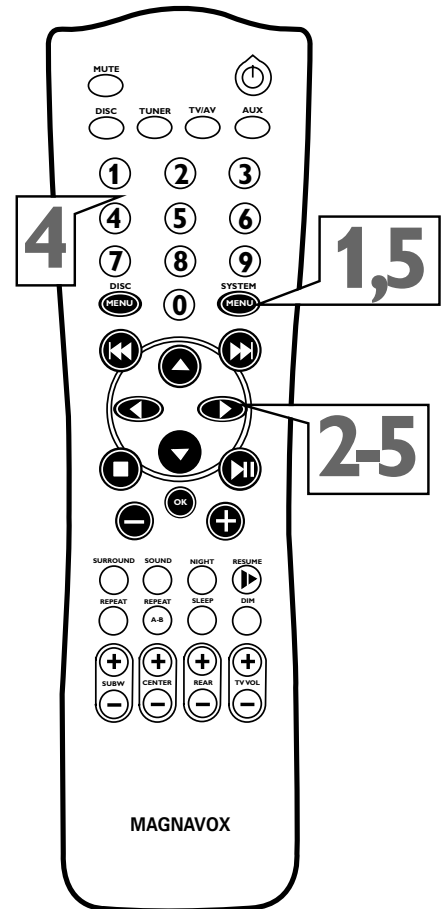



## Helpful Hints

- Some DVDs are not encoded with a rating, although the movie rating is printed on the Disc case. Parental Control will not block viewing of such Discs.
- Magnavox cannot guarantee the availability of Parental Control with all Discs, and therefore denies any liability associated with unintended watching of Discs.
- If you forget your password and cannot restore the default password, disconnect the DVD Receiver from power for a few minutes to restore the default password.

## 34 Parental Control Password, Defaults

### Parental Control Password

To set your four-digit password for Parental Control, follow these steps.

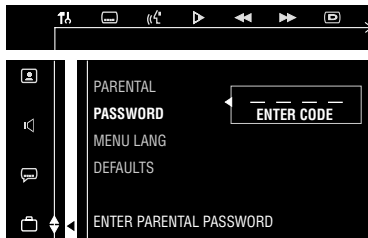

- 1** While playback is stopped, press **SYSTEM MENU**. Press ◀ or ▶ to select the  icon.
- 2** Press ▼ repeatedly to select , then press ▶.
- 3** Press ▼ to select **PASSWORD**.
- 4** Press ▶ to select **CHANGE**, then press **OK**.
- 5** Press **Number buttons 1, 2, 3, 4** (default password) when you are asked to enter the code.  
Or, press **STOP**  four times to restore the default password of 1-2-3-4. This may be helpful if you forget your password.  
**Notice to Parents:** You cannot reset the current Parental password without choosing a new code. If a password changes and you did not alter the code, then someone has reset the code and possibly viewed previously blocked or restricted level material.



- 6** Press the **Number buttons (0-9)** to enter your **NEW CODE** number. You will have to enter the same code twice to **CONFIRM CODE**.
- 7** Press **SYSTEM MENU** or **OK** to remove the menu.

### Defaults

To reset the DVD Receiver to its original settings, reset the defaults.

- 1** While playback is stopped, press **SYSTEM MENU**. Press ◀ or ▶ to select the  icon.
- 2** Press ▼ repeatedly to select , then press ▶.
- 3** Press ▼ to select **DEFAULTS**.
- 4** Press ▶ then ▼ to choose **RESET**, then press **OK**. This resets all features to the original settings.

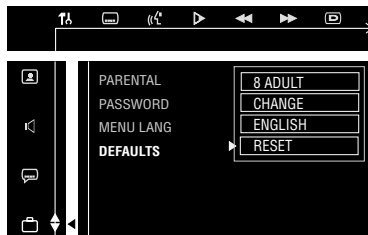

- 5** Press **SYSTEM MENU** or **OK** to remove the menu.

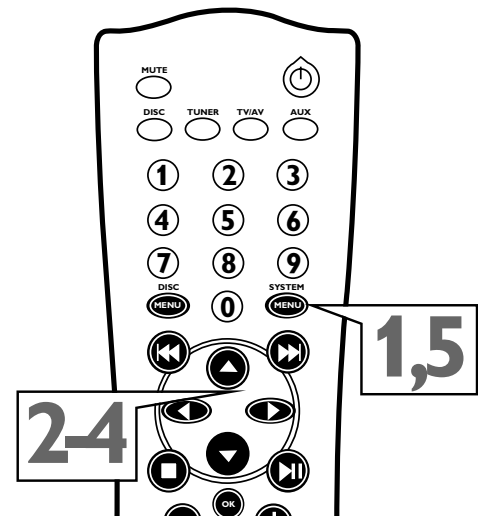
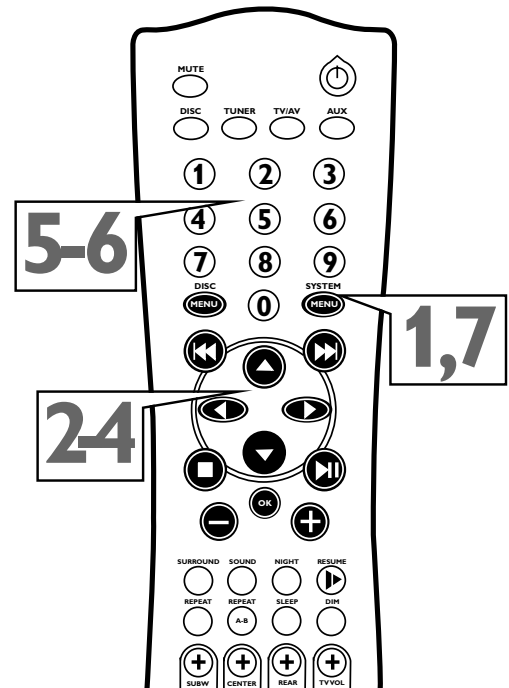

#### Helpful Hint

- If you forget your password and cannot restore the default password, disconnect the DVD Receiver from power for a few minutes to restore the default password.

## Adjusting the Volume

Turn the VOLUME dial on the DVD Receiver (or press VOL +/- on the remote) to increase or decrease the volume level of the DVD Home Cinema System.

- "VOL XX" will appear on the display panel, with "XX" being the specific volume level.
- If you have a Magnavox TV, press TV VOL +/- on the remote to adjust the TV's volume level.
- To listen through headphones (not supplied), connect the headphones to the  jack on the front of the DVD Receiver. The speakers will be muted.
- Press MUTE to turn off the volume. Playback will continue without sound. MUTE will appear on the DVD Receiver's display panel. Press MUTE again to restore the sound.

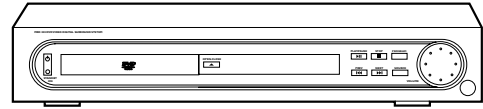

## Changing Surround Speaker Volume Levels

Besides adjusting the volume of the complete DVD Home Cinema System, you can set the sound level for individual speakers. This lets you personalize the sound as you prefer.

- 1 Press CENTER +/-** to adjust the volume of the Center speaker. "CNT +XX DB" will appear on the display panel. ("XX" denotes volume level between -15db and 10db.)
- 2 Press REAR +/-** to adjust the volume of the rear/surround speakers. "RE +XX DB" will appear on the display panel.
- 3 Press SUBW +/-** to adjust the volume of the Subwoofer. "SUB +XX DB" will appear on the display panel.

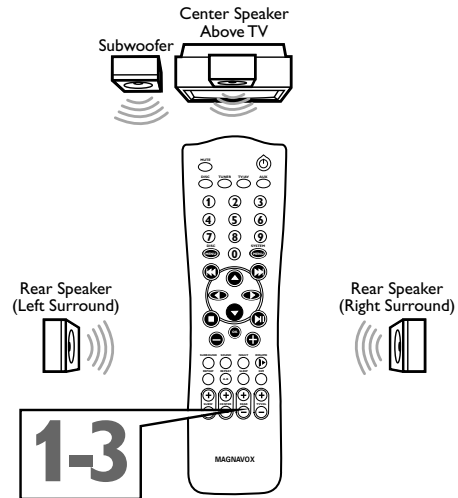

## Selecting Digital Sound Effects

Digital Sound Effects let you enhance your favorite music or soundtrack. Select a preset audio mode that matches your Disc's content or that optimizes the sound of the musical style you are playing.

- 1 Press SOUND** repeatedly to choose a sound effect.
  - During DVD or Video CD playback, select CONCERT, DRAMA, ACTION, or SCI-FI.
  - During Audio CD playback or while in TUNER or AUX mode, select CLASSIC, JAZZ, ROCK, or DIGITAL, depending on the style of music you are playing.

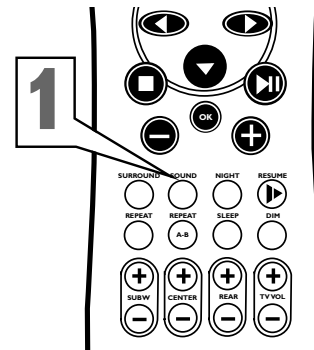

## 36 Surround Sound Options

For proper Surround Sound, you must connect the speakers correctly and select the right sound source mode. See page 13 and your separate Quick-Use Guide for details.

The Center and Surround speakers operate only when the DVD Home Cinema System is set to surround sound mode. The source you are playing (DVDs, Tuner, etc.) must be recorded or broadcast in Dolby Digital, DTS, or Dolby Pro Logic surround sound.

Stereo broadcasts or recordings will produce some surround sound effects when played in a surround mode. However, monaural (mono) sources will not produce any sound from the surround speakers.

### Selecting Surround Sound

- 1 Press SURROUND repeatedly to select a surround sound or stereo mode.** The availability of the various surround sound modes depends on the number of speakers connected and the sound information available on the Disc, etc.

Surround Sound options are:



- **Dolby Digital Surround** - Also referred to as AC-3, Dolby 5.1, or MPEG Multichannel - delivers a realistic, dynamic sound similar to theater and cinema. Many DVDs are recorded in Dolby Digital Surround.

All five speakers (front left, front right, center, surround left, and surround right) and the Subwoofer of the DVD Home Cinema System must be connected to the DVD Receiver.

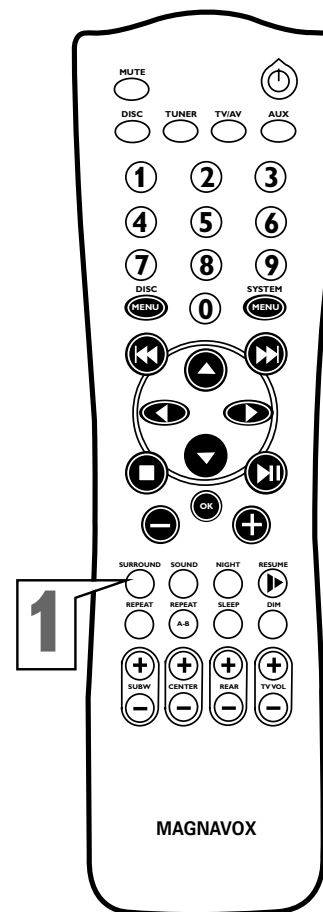
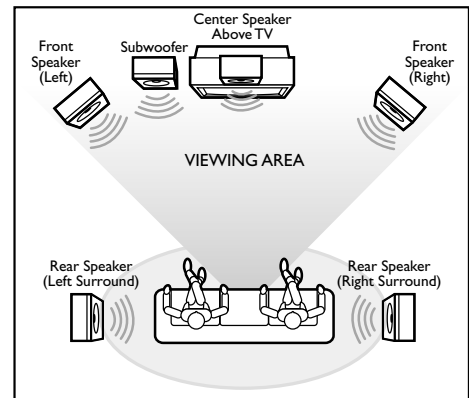
- **DTS (Digital Theater Systems) Surround** - A cinema surround sound format that offers superior digital audio performance. DTS offers more clarity and definition, especially for higher tones. The better sound quality is a result of the limited sound compression (3:1 instead of 11:1 for Dolby Digital) and 20-bit resolution.
- **Dolby Pro Logic Surround** - A specially encoded two-channel analog format that produces sound through four speakers (Front Left, Center, Front Right, and a single/monaural Surround) when using a Dolby Pro Logic Decoder. Dolby Pro Logic Surround is compatible with two-channel (right and left) Stereos, but you will have sound only from two channels (the left and right).
- **Matrix** - A new surround system that delivers four-channel surround sound (Front Left, Front Right, Surround Left, and Surround Right).
- **VSS (Virtual Surround Sound)** - The ProLogic, MPEG, or Dolby Digital surround sound is processed by a 'virtualizer' DSP, adding surround sound when using only the Front (left/right) speakers.
- **Stereo** - All sound is reproduced and played through the Front left/right speakers. This enables standard stereo reproduction.



## Tuning Radio Stations

- 1** Press **Power**  (or **STANDBY-ON**  on the front of the DVD Receiver) to turn on the last selected sound source.
- 2** Press **TUNER** on the remote (or turn the **SOURCE** dial on the DVD Receiver) to select **TUNER** mode.
- 3** Press **TUNER** again to select **FM** or **AM**.
- 4** Press and hold **◀◀** or **▶▶** until the frequency indicator (station number) starts to change, then release. The next radio station will tune automatically.
- 5** To tune to a weak station, press **◀◀** or **▶▶** briefly and repeatedly until the best possible reception is found.

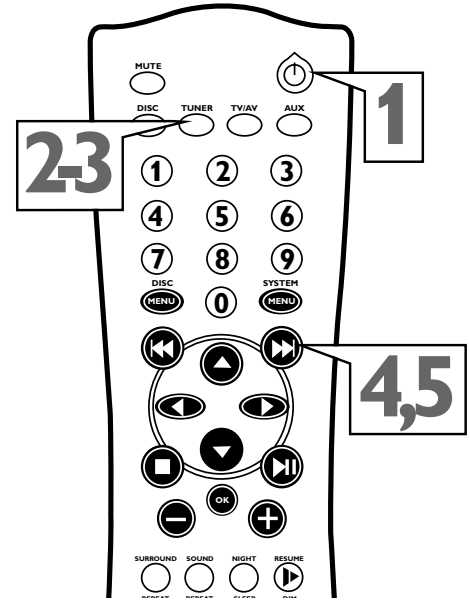

## Programming Radio Stations

You can preset up to 40 stations in memory.

- 1** Tune to the desired radio station as detailed above.
- 2** Press **PROGRAM** on the front of the DVD Receiver. "Program" will appear on the display panel.
- 3** Within five seconds, press the **Number buttons (0-9)** to select a preset number.
  - If "Program" disappears from the display panel before you select a preset number, repeat steps 2-3.
- 4** Within five seconds, press **PROGRAM** to store the radio station. Repeat steps 1-4 to store other radio stations.
  - If you try to program more than 40 preset radio stations, "FULL" will appear on the display panel.

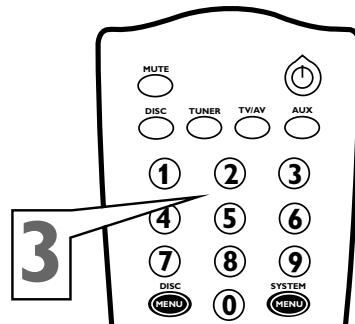
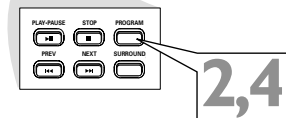

## Selecting Preset Radio Stations

- 1** In **Tuner** mode, press **◀** or **▶** or use the **Number buttons** to select a preset station number. The preset station number, radio frequency, and **FM** or **AM** will appear on the display panel.

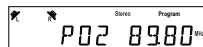

## 38 Sleep Timer

The Sleep Timer turns the DVD Home Cinema System to Standby mode (off) at a preselected time.

- 1 Press **SLEEP** repeatedly to select the amount of time after which you want the DVD Receiver to turn off. You may choose (in minutes): 30, 45, 60, 90, 120, or OFF.



- **To check the time** remaining for the Sleep Timer (after you have set it), press SLEEP once.
- **To change the Sleep Timer**, press SLEEP again while the Sleep Timer minutes appear. The next Sleep Timer option will appear on the display panel.
- **To cancel the Sleep Timer**, press SLEEP repeatedly to choose OFF. Or, press STANDBY-ON  to turn off the DVD Receiver.

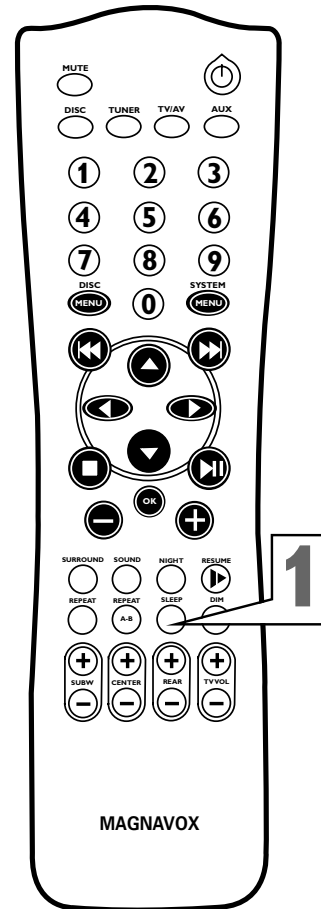

## **WARNING!**

Under no circumstances should you try to repair the system yourself, as this will invalidate the warranty. Do not open the system as there is a risk of electric shock.

If you are having problems with your product, check this list of problems and possible solutions before requesting service. You may be able to solve the problem yourself.

## **No power**

- Press STANDBY-ON  on the front of the DVD Receiver to turn on the power.
- Make sure you connected the DVD Receiver's power cord to an AC power outlet.
- Make sure the AC outlet has power by trying another appliance in the same outlet.

## **No picture**

- Make sure the TV power is on.
- Check the video cables. Make sure the cable(s) are fastened securely to the DVD Receiver and TV.
- Set your TV to the correct Video In channel. These channels are usually near channel 00. Or, you may have a button on the TV remote control that selects an Auxiliary or A/V IN channel. See your TV owner's manual for details. Or, go to your lowest TV channel and change channels down until you see the DVD screen on the TV.
- You only need one video connection between the DVD Receiver and the TV.
- Adjust VIDEO OUT if you used S-Video or Component Video. *Details are on page 28.*
- Press the correct source button (TV/AV, DISC, TUNER, or AUX) to choose what you want to watch.

## **Distorted picture**

- Check the Disc for fingerprints. Clean the Disc with a soft cloth, wiping from the center to the edge in a straight line.
- Sometimes a small amount of picture distortion may appear. This is not a malfunction.

## **The picture is distorted, the picture rolls, or the picture is only black and white.**

- TVs have a color system standard, usually NTSC in the United States. If the Disc's or DVD Receiver's color system is different than your TV's color system, the picture may be distorted or colorless. Adjust the TV SYSTEM setting at the DVD Receiver. *Details are on page 26.*
- Check the VIDEO OUT setting. *Details are on page 28.*  
If you connected the DVD Receiver to a TV using S-Video cable (as described on page 12), set VIDEO OUT to S-VIDEO.  
If you connected the DVD Receiver to a TV using Component video cable (red, green, and blue as described on page 11), set VIDEO OUT to PR PB Y.

## **The sound is distorted or there is no sound.**

- Make sure you did not connect any cables from the DVD Receiver to a Stereo's "PHONO IN" jack.
- Make sure you did not connect the DIGITAL OUT - COAXIAL or OPTICAL jack on the DVD Receiver to an analog jack on the Stereo. (Analog audio jacks are usually labeled as such and are usually red and white.)
- Check the speaker connections. Make sure cables are connected firmly to all equipment. *Details are on page 13.*
- Choose the correct Audio/Video In or Auxiliary channel at your TV. See your TV's manual for details. Or, change channels at the TV until you hear sound from the Disc that is in the DVD Receiver or until you see the DVD screen on your TV.
- Choose a different Audio setting. *Details are on pages 18, 29, and 34.* Check the Audio setting of a DVD in the DVD Disc Menu, if available, and adjust as necessary.
- Choose the correct sound source at the DVD Receiver. Press TV/AV, DISC, TUNER, or AUX on the DVD Receiver's remote control to choose the equipment that you want to hear through the DVD Receiver.
- Check the Surround Sound setting. Make sure it is compatible/available with the current Disc. *Details are on page 35.*
- Adjust the volume. *Details are on page 34.*
- Replace the speaker cables.
- Check the speaker settings. *Details are on page 30.*
- Sound is mute during slow motion, searching, or paused Disc playback. Press PLAY/PAUSE  to resume normal playback and restore the sound.

## **Disc will not play.**

- Make sure the Disc label is facing up. If you are playing a two-sided Disc, make sure the label of the side you want to play is facing up when you place the Disc in the DVD Receiver's disc tray. *Details are on page 15.*
- Check the Parental Controls. *Details are on pages 32-33.*
- Check the Region Code of the DVD. The DVD must be coded for All regions or Region I in order to play on this DVD Receiver. *Details are on page 5.*
- See if the Disc is defective by trying another Disc. Make sure the Disc is not scratched or warped. Carefully clean the Disc.
- Check the color system of the DVD. It must be recorded in NTSC or PAL. Adjust the TV SYSTEM setting at the DVD Receiver appropriately. *Details are on page 26.*
- Press SYSTEM MENU to remove the System Menu. Then try playing the Disc again.
- Moisture may have condensed inside the DVD Receiver. Remove the Disc and leave the DVD Receiver power on for about an hour before trying to play Discs again. Moisture may condense inside the DVD Receiver if you move it suddenly from a warm place to a cold environment, or vice versa.

## 40 Helpful Hints (cont'd)

---

### **An Audio CD will not play.**

- Some Audio CDs available on the market are copy protected. These discs will not play on this DVD Receiver. See your retailer for options regarding non-protected Audio CDs.

### **The DVD Receiver does not respond to the remote control.**

- Aim the remote control directly at the remote sensor on the front of the DVD Receiver, not your TV. *Details are on page 7.*
- Remove any obstacles between the DVD Receiver and the remote. Move closer to the DVD Receiver and try again.
- Inspect or replace the batteries in the remote control. *Details are on page 9.*
- Use the SOURCE buttons (TV/AV, DISC, TUNER, AUX) to place the remote in the right mode. For example, when using the remote to start Disc playback, press DISC first.

### **You cannot activate some features, such as Angles, Subtitles, or multi-language Audio.**

- The feature may not be available on the Disc. Check the Disc case to see if the Disc has the feature. If the Disc does not have the feature, the DVD Receiver cannot create the feature. This is not a malfunction of the DVD Receiver.

### **The DVD Receiver does not work.**

- Disconnect the power cord from the power outlet for a few minutes. Reconnect the power cord and try to operate the DVD Receiver again as usual.

### **There is no sound from the Center or Rear/Surround speakers.**

- Press CENTER +/- or REAR +/- on the remote control to adjust the volume level.
- Make sure the Center and Rear/Surround speakers are connected correctly. *Details are on page 13.*
- Choose a correct Surround Sound setting. Surround Sound must be available on the current Disc or broadcast. *Details are on page 35.*

### **Radio broadcasts are noisy or have considerable static.**

- Tune to the correct frequency. *Details are on page 36.*
- Connect the antennas. *Details are on page 9.*
- Route Cable TV/RF/AC-3 and digital cables away from the antennas and speaker wires.
- Fully extend the FM wire antenna and position it for the best reception.
- Connect an outdoor FM or AM antenna.
- Turn off other equipment that is near the DVD Receiver. It may be causing interference. Move other equipment away from the DVD Receiver. Move the DVD Receiver's antennas away from the other equipment.

### **The display panel is dark.**

- Press DIM repeatedly until you can see the information on the display panel.

### **You hear a low hum or buzz sound.**

- Place the DVD Receiver as far as possible from electric devices that may cause interference.

### **Bass response is low.**

- Check the polarity (+/- wires and jacks) of all the Speakers.



# Specifications 41

## AMPLIFIER SECTION

Output power Stereo (DIN)	.2 x 50 W
Output power Surround (1 kHz)	.20 W RMS/channel
Total Harmonic Distortion	.10% at rated power (1 kHz)
Frequency Response	180 Hz – 14 kHz / $\pm 1$ dB
Signal-to-Noise Ratio	> 65 dB (CCIR)
Input Sensitivity	.400 mV

## TUNER SECTION

Tuning Range	.FM 87.5–108MHz (100kHz steps) .AM 530–1700kHz (10kHz steps)
26 dB Quietening Sensitivity	.FM 20 dB/AM 3162 $\mu$ V/m
Image Rejection Ratio	.FM 25 dB/AM 28 dB
IF Rejection Ratio	.FM 60 dB/AM 24 dB
Signal-to-Noise Ratio	.FM 60 dB/AM 40 dB
AM Suppression Ratio	.FM 30 dB
Harmonic Distortion	.FM Mono 3%/FM Stereo 3%/AM 5%
Frequency Response	.FM 180Hz–10kHz / $\pm 6$ dB
Stereo Separation	.FM 26 dB (1 kHz)
Stereo Threshold	.FM 23.5 dB

## DVD SECTION

Laser Type	.Semiconductor
Disc Diameter	.12cm/8cm
Video Decoding	.MPEG-2
Video DAC	.10 Bits
Color System	.PAL/NTSC
Video Format	.4:3/16:9
Video S/N	.56 dB (minimum)
Composite Video Output	.1.0 Vp-p, 75 $\Omega$
S-Video Output	.Y - 1.0 Vp-p, 75 $\Omega$ .C - 0.286 Vp-p, 75 $\Omega$
Audio DAC	.24 bits / 96 kHz
Frequency Response	.4 Hz – 20 kHz (44.1 kHz) .4 Hz – 22 kHz (48 kHz) .4 Hz – 44 kHz (96 kHz)
Digital Output	.SPDIF Coaxial & Optical

## LASER

Type	.Semiconductor laser GaAlAs
Wavelength	.650 nm
Output Power	.7 mW
Beam Divergence	.60 degree

## MISCELLANEOUS

Power Supply Rating	.120 V / 60 Hz
Power Consumption	.120 W
Dimensions (w x h x d)	.435 mm x 78 mm x 360 mm .17.1 x 3.1 x 14.2 (inches)
Weight	.7.1 kg/15.62 lbs.

## REMOTE CONTROL

Effective Range	.> Eight Meters
Number of Buttons	.45
Batteries (1.5V)	.2 AA

## SPEAKERS

### Front speakers/ Rear (surround) speaker

System	.2-way satellite
Impedance	.8 $\Omega$
Speaker drivers	.3" woofer, piezo
Dimensions (w x h x d)	.94 mm x 155 mm x 88 mm .3.7 x 6.1 x 3.5 (inches)
Weight	.0.45 kg each or 0.99 pounds each

### Center Speaker

System	.2-way satellite
Impedance	.8 $\Omega$
Speaker drivers	.2 x 3" woofer, piezo
Dimensions (w x h x d)	.250 mm x 94 mm x 88 mm .9.84 x 3.70 x 3.46 (inches)
Weight	.0.92 kg/2.02 lbs.

### SUBWOOFER

Subwoofer (not magnetically shielded)	.6.5"
Output power	.75 W (4 $\Omega$ , DIN)
THD	.10% at 80 Hz
Reproduction frequency response	.30 Hz – 150 Hz
Phase switch	.0°, 180°
Input sensitivity (Subwoofer In)	.200 mVrms
AC power	.120 V / 60 Hz
Power Consumption	.53W (at 1/8 rated power)
Dimensions (w x h x d)	.130 mm x 337 mm x 375 mm .5.1 x 13.3 x 14.8 (inches)
Weight	.7.8 kg/17.2 lbs.

Specifications are subject to change without notice.

## 42 Glossary

---

**Analog:** Sound that has not been turned into numbers. Analog sound varies, while digital sound has specific numerical values. Analog sound is available when you use the red and white audio jacks on your equipment. These jacks send audio through two channels, the left and right.

**AUDIO OUT Jacks:** Jacks on the back of the DVD Receiver that send audio to another system (TV, Stereo, etc.).

**Bit Rate:** The amount of data used to hold a given length of music; measured in kilobits per seconds, or kbps. Or, the speed at which you record. Generally, the higher the bit rate, or the higher the recording speed, the better the sound quality. However, higher bit rates use more space on a Disc.

For example, an MP3 music file recorded at 32 kbps will record slowly, use the least Disc space, and have the poorest sound quality. But, an MP3 music file recorded at 96 kbps will record quicker, use more Disc space, and have significantly better sound quality.

**CD:** Compact Disc (audio).

**Coaxial jack:** Sends digital audio to a Stereo, allowing you to adjust the volume at the Stereo. The Stereo must have a coaxial in jack. This connection provides the 5.1 channel surround sound as heard in movie theaters.

**Component Video Out Jacks:** Jacks on the back of the DVD Receiver that send high-quality video to a TV that has Component Video In jacks.

**Digital:** Sound that has been converted into numerical values. Digital sound is available when you use the DIGITAL AUDIO OUT COAXIAL or OPTICAL jacks. These jacks send audio through multiple channels, instead of just two channels as analog does.

**Dolby Digital:** A surround sound system that provides 5.1 channel sound as used in movie theaters.

**DTS:** Digital Theater Systems. This is a surround sound system, but it is different from Dolby Digital. The formats were developed by different companies.

**DVD:** Digital Video Disc.

**Letterbox:** A TV aspect ratio setting (4:3). Displays the video in full-width, with black bars at the top and bottom of the TV screen. This format is similar to seeing a movie in a theater. If the Disc does not include a letterbox format, selecting Letterbox may have no effect. (For example, some DVDs are two-sided, with one side playing in Letterbox and the other side playing in a normal format.)

**OPTICAL Jack:** Converts electrical signals into optical signals before sending the audio to the Stereo. Optical audio is not prone to external electrical influences and has less noise, which reduces adverse effects on external equipment. Be sure to keep the protective cap on the jack when the jack is not in use. This keeps dust out of the jack.

**Pan & Scan:** A TV aspect ratio setting (4:3). Displays the video with full-height picture, with one or both sides of the picture trimmed. Some movie companies refer to this as “reformatting the picture to fit your TV screen.”

**PR PB Y:** See *Component Video Out Jacks*.

**Remote Control:** The unit that came with your DVD Receiver and allows you to operate your DVD Receiver from a distance.

**S-Video:** Produces a clear picture by sending separate signals for the luminance and the color. You can use S-Video only if your TV has an S-Video In jack.

**VIDEO OUT Jack:** Jack on the back of the DVD Receiver that sends video to a TV.

**Widescreen:** A TV aspect ratio setting (16:9). Displays the video appropriately when you connect the DVD Receiver to a widescreen TV.

- ac power cord ..... 8
- albums (mp3) ..... 24
- am antenna ..... 8-9
- analog ..... 42
- angle ..... 23
- antennas ..... 8-9
- arrow buttons ..... 6
- aspect ratio (tv shape) ..... 28
- audio cd ..... 5
- audio language ..... 19, 32
- audio in (tv/aux) jacks ..... 8, 10-12, 15
- audio out jacks ..... 8, 15, 42
- auto (tv system) ..... 27
- aux button ..... 6
  
- bass ..... 35
- bass button ..... 7, 35
- batteries ..... 9
- bit rates ..... 24, 42
  
- cable connection ..... 15
- camera angle ..... 23
- cd ..... 42
- center delay ..... 31
- center +/- buttons ..... 6, 35
- chapters ..... 17, 21
- cleaning discs ..... 5
- coaxial jack ..... 8, 14, 42
- code (parental control password) ..... 34
- color system ..... 5, 27
- component video out jacks ..... 8, 11, 42
- connections ..... 10-15
- contents, table of ..... 3
- controls, remote ..... 6
  
- default settings ..... 34
- digital ..... 42
- digital out jacks ..... 8, 14
- digital output ..... 30
- digital sound effects ..... 35
- dim button ..... 6
- disc button ..... 6
- disc menu button ..... 6, 16, 29
- disc menus ..... 16, 32
- disc tray ..... 7, 16
- display panel ..... 7
- dolby digital surround ..... 36, 42
- dolby pro logic surround ..... 36
- dts (digital theater systems) surround ..... 36, 42
- dvd disc menus ..... 16
- dvd video ..... 5
  
- fast forward searching ..... 17, 20
- favorite track selection ..... 26
- fm antenna ..... 8-9
- front panel ..... 7
  
- glossary ..... 42
- headphones (🎧) jack ..... 7, 35
- helpful hints ..... 39-40
- hookups ..... 10-15
- jpeg images ..... 23
- language ..... 19, 32
- letterbox ..... 28, 42
- limited warranty ..... 44
- maintenance ..... 5
- matrix ..... 36
- menu language ..... 32
- menus ..... 16, 18
- mp3 ..... 24
- mute button ..... 6, 35
- next ►► button ..... 7
- night button ..... 6, 30
- night mode ..... 30
- ntsc ..... 5, 27
- number buttons ..... 6
- ok button ..... 6, 18
- open/close ▲ button ..... 7, 16
- optical jack ..... 8, 14, 42
- pal ..... 5, 27
- pan & scan ..... 28, 42
- parental control levels ..... 33
- parental control password ..... 34
- password ..... 34
- paused playback ..... 17
- pbcb ..... 24
- pcm ..... 30
- play/pause ►|| button ..... 6-7, 16-17
- playable discs ..... 5
- playback control ..... 24
- playing a disc ..... 16-17
- power ⏻ button ..... 6
- power cord ..... 8
- pr/cr pb/cb y jacks ..... 8, 11
- prpby (video out setting) ..... 29
- preset radio stations ..... 37
- prev(ious) ◀◀ button ..... 7
- program (favorite track selection) ..... 26
- program button ..... 7, 26, 37
- radio stations ..... 37
- rear delay ..... 31
- rear +/- buttons ..... 6, 35
- rear panel ..... 8
- region codes ..... 5
- remote control ..... 42
- remote control buttons ..... 6
- repeat a-b ..... 25
- repeat a-b button ..... 6, 25
- repeat button ..... 6, 25
- repeat playback ..... 25
- resume ..... 17
- resume ▶ button ..... 6, 17
- reverse searching ..... 17, 20
- safety precautions ..... 4
- satellite connection ..... 15
- searching ..... 17, 20
- screen saver ..... 29
- sleep button ..... 6, 38
- sleep timer ..... 38
- slow motion ..... 20
- sound button ..... 6, 35
- sound sources ..... 16
- source buttons ..... 6
- source dial ..... 7
- speaker jacks ..... 8, 13
- speaker settings ..... 31
- speaker volume ..... 35
- specifications ..... 41
- standby-on ⏻ button ..... 7
- status ..... 22
- step-by-step playback ..... 23
- stereo ..... 36
- stop ■ button ..... 6-7, 16-17
- subtitles ..... 19, 32
- subw +/- buttons ..... 6, 35
- subwoofer ..... 8, 13, 35, 41
- surround button ..... 6, 7, 36
- surround sound ..... 36
- s-video ..... 12, 29, 42
- s-video out jack ..... 8, 12
- system menu ..... 18, 32
- system menu button ..... 6, 18
  
- table of contents ..... 3
- test tone ..... 31
- time search ..... 21
- title/chapter search ..... 18, 21
- titles ..... 18, 21
- track selection ..... 17
- treble ..... 35
- treble button ..... 7, 35
- tuner button ..... 6, 37
- tv/av button ..... 6
- tv shape ..... 28
- tv system ..... 5, 27
- tv vol +/- buttons ..... 6, 35
  
- vcr ..... 15
- video cd ..... 5, 24
- video out ..... 29
- video out jack ..... 8, 10, 42
- volume ..... 35
- volume dial ..... 7
- vol(ume) +/- buttons ..... 6, 35
- vss (virtual surround sound) ..... 36
- warranty ..... 44
- widescreen tv ..... 28, 42
- woofer line out jack ..... 8
  
- zoom ..... 22

# 44 Limited Warranty

## LIMITED WARRANTY

### MAGNAVOX AUDIO SYSTEM

One Year Free Exchange

This product must be carried in for an exchange.

#### WHO IS COVERED?

You must have proof of purchase to exchange the product. A sales receipt or other document showing that you purchased the product is considered proof of purchase. Attach it to this owner's manual and keep both nearby.

#### WHAT IS COVERED?

Warranty coverage begins the day you buy your product. For one year thereafter, a defective or inoperative product will be replaced with a new, renewed, or comparable product at no charge to you. A replacement product is covered only for the original warranty period. When the warranty on the original product expires, the warranty on the replacement product also expires.

#### WHAT IS EXCLUDED?

Your warranty does not cover:

- labor charges for installation or setup of the product, adjustment of customer controls on the product, and installation or repair of antenna systems outside of the product.
- product repair and/or part replacement because of misuse, accident, unauthorized repair or other cause not within the control of Magnavox.
- reception problems caused by signal conditions or cable or antenna systems outside the unit.
- a product that requires modification or adaptation to enable it to operate in any country other than the country for which it was designed, manufactured, approved and/or authorized, or repair of products damaged by these modifications.
- incidental or consequential damages resulting from the product. (Some states do not allow the exclusion of incidental or consequential damages, so the above exclusion may not apply to you. This includes, but is not limited to, prerecorded material, whether copyrighted or not copyrighted.)
- a product that is used for commercial or institutional purposes.

#### WHERE IS EXCHANGE AVAILABLE?

You may exchange the product in all countries where the product is officially distributed by Magnavox. In countries where Magnavox does not distribute the product, the local Magnavox service organization will attempt to provide a replacement product (although there may be a delay if the appropriate product is not readily available).

#### BEFORE REQUESTING EXCHANGE...

Please check your owner's manual before requesting an exchange. Adjustments of the controls discussed there may save you a trip.

#### EXCHANGING A PRODUCT IN U.S.A., PUERTO RICO, OR U.S. VIRGIN ISLANDS...

Contact your dealer to arrange an exchange. Or, ship the product, insured and freight prepaid, and with proof of purchase enclosed, to the address listed below.

Small Product Service Center  
Magnavox  
1001 Snapps Ferry Road  
Plant 2, Building 6  
Greeneville, TN 37743

(In U.S.A., Puerto Rico, and U.S. Virgin Islands, all implied warranties, including implied warranties of merchantability and fitness for a particular purpose, are limited in duration to the duration of this express warranty. But, because some states do not allow limitations on how long an implied warranty may last, this limitation may not apply to you.)

#### EXCHANGING A PRODUCT IN CANADA...

Please contact Magnavox at:

1-800-661-6162 (French Speaking)

1-800-705-2000 (English Speaking or Spanish Speaking)

(In Canada, this warranty is given in lieu of all other warranties. No other warranties are expressed or implied, including any implied warranties of merchantability or fitness for a particular purpose. Magnavox is not liable under any circumstances for any direct, indirect, special, incidental or consequential damages, howsoever incurred, even if notified of the possibility of such damages.)

#### REMEMBER...

Please record below the model and serial numbers found on the product. Also, please fill out and mail your warranty registration card promptly. It will be easier for us to notify you if necessary.

MODEL # \_\_\_\_\_

SERIAL # \_\_\_\_\_

*This warranty gives you specific legal rights. You may have other rights which vary from state/province to state/province.*