

MRF581
MRF581G
MRF581A
MRF581AG

*G Denotes RoHS Compliant, Pb free Terminal Finish

RF & MICROWAVE DISCRETE LOW POWER TRANSISTORS

Features

- Low Noise - 2.5 dB @ 500 MHz
- Gain at Optimum Noise Figure = 15.5 dB @ 500 MHz
- Ftau - 5.0 GHz @ 10v, 75mA
- Cost Effective MacroX Package

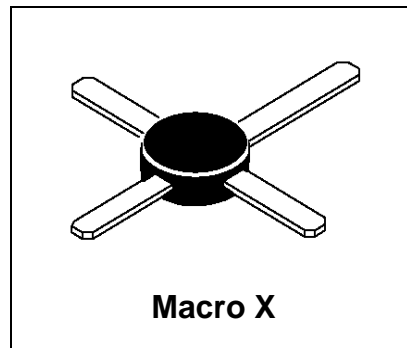

DESCRIPTION: Designed for high current, low power, low noise, amplifiers up to 1.0 GHz.

ABSOLUTE MAXIMUM RATINGS (T_{case} = 25°C)

Symbol	Parameter	MRF581	MRF581A	Unit
V _{CEO}	Collector-Emitter Voltage	18	15	Vdc
V _{CBO}	Collector-Base Voltage	30		Vdc
V _{EBO}	Emitter-Base Voltage	2.5		Vdc
I _C	Collector Current	200		mA

Thermal Data

P _D	Total Device Dissipation @ TC = 50°C Derate above 50°C	2.5 25	Watts mW/ °C
P _D	Total Device Dissipation @ TC = 25°C Derate above 25°C	1.25 10	Watts mW/ °C
T _{stg}	Storage Junction Temperature Range	-65 to +150	°C
T _{Jmax}	Maximum Junction Temperature	150	°C

Revision A- December 2008

ELECTRICAL SPECIFICATIONS (Tcase = 25°C)

STATIC (off)

Symbol	Test Conditions		Value			Unit
			Min.	Typ.	Max.	
BVCEO	Collector-Emitter Breakdown Voltage (IC = 5.0 mAdc, IB = 0)	MRF581 MRF581A	18 15	-	-	Vdc
BVCBO	Collector-Base Breakdown Voltage (IC = 1.0 mAdc, IE = 0)		30	-	-	Vdc
BVEBO	Emitter-Base Breakdown Voltage (IE = 0.1 mAdc, IC = 0)		2.5	-	-	Vdc
ICBO	Collector Cutoff Current (VCB = 15 Vdc, VBE = 0 Vdc)		-	-	0.1	mA
IEBO	Emitter Cutoff Current (Vbe = 2.5 Vdc)		-	-	0.1	mA

(on)

HFE	DC Current Gain (IC = 50 mAdc, VCE = 5.0 Vdc)	MRF581 MRF581A	50 90	-	200 250	-
-----	--	-------------------	----------	---	------------	---

DYNAMIC

Symbol	Test Conditions		Value			Unit
			Min.	Typ.	Max.	
COB	Output Capacitance (VCB = 10 Vdc, IE = 0, f = 1.0 MHz)		-	2.0	3.0	pF
Ftau	Current-Gain Bandwidth Product (IC = 75 mAdc, VCE = 10 Vdc, f = 1.0 GHz)		-	5.0	-	GHz

FUNCTIONAL

Symbol	Test Conditions	Value			Unit
		Min.	Typ.	Max.	
NF	Noise Figure (50ohms) (IC = 50 mAdc, VCE = 10 Vdc, f = 0.5 GHz)	-	3.0	3.5	dB
G_{NF}	Power Gain @ NFmin (IC = 50 mAdc, VCE = 10 Vdc, f = 0.5 GHz)	13	15.5		dB
$G_{U\max}$	Maximum Unilateral Gain (1) IC = 50 mAdc, VCE = 10 Vdc, f = 500 MHz	-	17.8	-	dB
MSG	Maximum Stable Gain IC = 50 mAdc, VCE = 10 Vdc, f = 500 MHz	-	20	-	dB
$ S_{21} ^2$	Insertion Gain IC = 50 mAdc, VCE = 10 Vdc, f = 500 MHz	14	15	-	dB

Table 1. Common Emitter S-Parameters, @ VCE = 10 V, IC = 50 mA

f (MHz)	S11		S21		S12		S22	
	S11	$\angle \phi$	S21	$\angle \phi$	S12	$\angle \phi$	S22	$\angle \phi$
100	.610	-137	23.8	116	.026	46	.522	-78
200	.659	-161	13.2	98	.033	47	.351	-106
300	.671	-171	9.0	89	.040	51	.304	-120
400	.675	-178	6.8	83	.047	55	.292	-128
500	.677	176	5.5	77	.055	58	.293	-132
600	.678	172	4.6	72	.064	61	.299	-134
700	.677	168	4.0	68	.073	62	.306	-135
800	.679	184	3.5	64	.082	63	.314	-136
900	.678	160	3.1	60	.092	64	.322	-138
1000	.682	156	2.8	56	.102	65	.311	-139

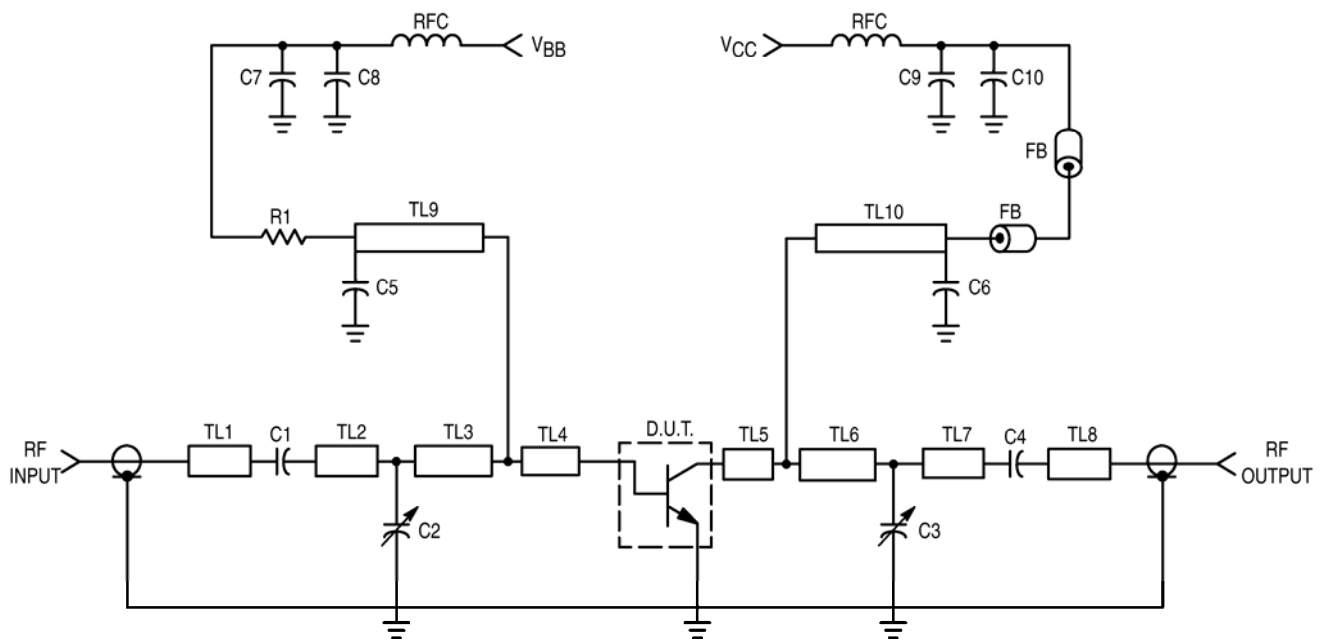

C1, C4, C5, C6, C8, C9 — 1000 pF, Chip Capacitor
 C7, C10 — 10 μ F, Tantalum Capacitor
 RFC — VK-200, Ferroxcube
 TL1, TL7, TL8 — Microstrip 0.162, x 0.600,
 TL3 — Microstrip 0.162, x 0.800,
 TL5 — Microstrip 0.120, x 0.440,
 TL9, TL10 — Microstrip 0.025, x 4.250,
 Board Material — 0.0625, Thick Glass Teflon $\epsilon r = 2.55$

C2, C3 — 1.0–10 pF, Johanson Capacitor
 R1 — 1.0 k Ω Res.
 FB — Ferrite Bead, Ferroxcube, 56–590–65/3B
 TL2 — Microstrip 0.162, x 1.000,
 TL4 — Microstrip 0.162, x 0.440,
 TL6 — Microstrip 0.120, x 1.160,

Figure 1. Minimum Noise Figure and Gain @ Minimum Noise Figure.

RF Low Power PA, LNA, and General Purpose Discrete Selector Guide

Package	Device	Type	GPE Freq (MHz)	Pout (watts)	GPE (dB)	Efficiency (%)	GPE VCC	BVCEO	IC max (mA)
SO-8	MRF4427, R2	NPN	175	0.15	18	60	12	20	400
TO-39	2N4427	NPN	175	1	10	50	12	20	400
POWER MACRO	MRF553	NPN	175	1.5	11.5	60	12.5	16	500
POWER MACRO	MRF553T	NPN	175	1.5	11.5	50	12.5	16	500
TO-39	MRF607	NPN	175	1.75	11.5	50	12.5	16	330
TO-39	2N6255	NPN	175	3	7.8	50	12.5	18	1000
TO-72	2N5179	NPN	200		20	6	12	50	
MACRO X	MRF559	NPN	512	0.5	10	65	7.5	16	150
MACRO X	MRF559	NPN	512	0.5	13	60	12.5	16	150
TO-39	2N3866A	NPN	400	1	10	45	28	30	400
SO-8	MRF3866, R1, R2	NPN	400	1	10	45	28	30	400
POWER MACRO	MRF555	NPN	470	1.5	11	50	12.5	16	400
POWER MACRO	MRF555T	NPN	470	1.5	11	50	12.5	16	400
MACRO X	MRF559	NPN	870	0.5	6.5	70	7.5	16	150
MACRO X	MRF559	NPN	870	0.5	9.5	65	12.5	16	150
SO-8	MRF8372, R1, R2	NPN	870	0.75	8	55	12.5	16	200
POWER MACRO	MRF557	NPN	870	1.5	8	55	12.5	16	400
POWER MACRO	MRF557T	NPN	870	1.5	8	55	12.5	16	400

RF (Low Power PA / General Purpose) Selection Guide

Package	Device	Type	Freq (MHz)	NF (dB)	NF IC (mA)	NF VCE	GN (dB)	Gu Max (dB)	Ft au (MHz)	Ccb (pF)	BVCEO	IC max (mA)
TO-39	2N5109	NPN	200	3	10	15		12	1200	3.5	20	400
TO-39	MRF5943C	NPN	200	3.4	30	15		11.4	1000		30	400
SO-8	MRF5943, R1, R2	NPN	200	3.4	30	15		15	1300		30	400
TO-72	2N5179	NPN	200	4.5	1.5	6		17	900	1	12	50
TO-72	2N2857	NPN	300	5.5	50	6		13	1600	1	15	40
TO-39	MRF517	NPN	300	7.5	50	15		5.5	4600	3	25	150
TO-72	MRF904	NPN	450	1.5	5	6		11	4000	1	15	30
TO-39	2N6304	NPN	450	5	2	5		14	1400	1	15	50
MACRO T	BFR91	NPN	500	1.9	2	5	11	16.5	5000	1	12	35
MACRO T	BFR96	NPN	500	2	10	10		14.5	500	2.6	15	100
SO-8	MRF5812, R1, R2	NPN	500	2	50	10	15.5	17.8	5000		15	200
MACRO X	MRF581A	NPN	500	2	50	10	14	15	5000		15	200
Macro	BFR90	NPN	500	2.4	2	10	15	18	5000	1	15	30
TO-72	BFY90	NPN	500	2.5	2	5		20	1300		15	50
TO-72	MRF914	NPN	500	2.5	5	10		15	4500		12	40
MACRO X	MRF581	NPN	500	2.5	50	10	15	17.8	5000		16	200
TO-39	MRF586	NPN	500	3	90	15	11	14.5	4500	2.2	17	200
MACRO X	MRF951	NPN	1000	1.3	5	6	14	17	8000	0.45	10	100
MACRO X	MRF571	NPN	1000	1.5	10	6	10		8000	1	10	70
MACRO T	BFR91	NPN	1000	2.5	2	5	8	11	5000	1	12	35
MACRO T	BFR90	NPN	1000	3	2	10	10	12.5	5000	1	15	30
TO-39	MRF545	PNP						14	1400	2	70	400
TO-39	MRF544	NPN						13.5	1500		70	400

RF (LNA / General Purpose) Selection Guide

Low Cost RF Plastic Package Options

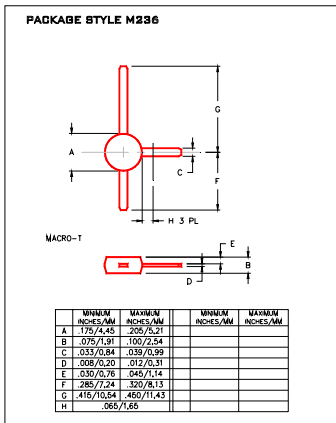

Macro T

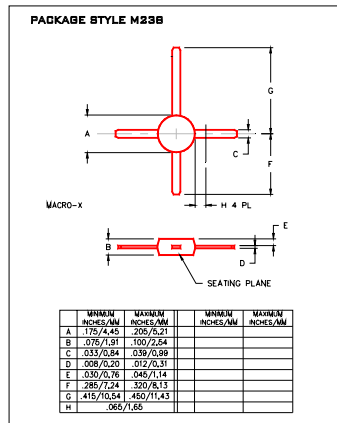

Macro X

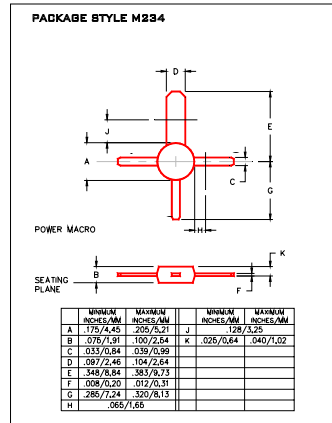

Power

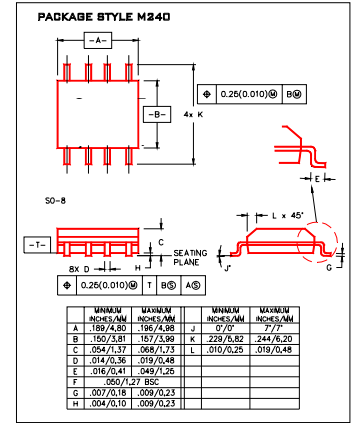

SO-8

PACKAGE STYLE M238

- PIN 1. COLLECTOR
 2. EMITTER
 3. BASE
 4. EMITTER

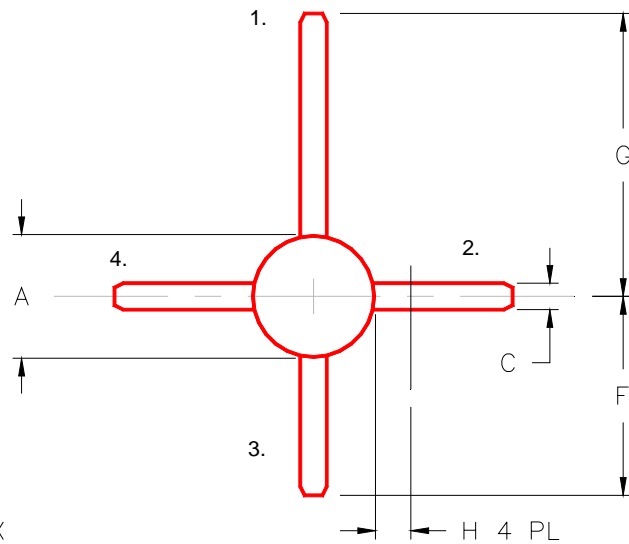

MACRO-X

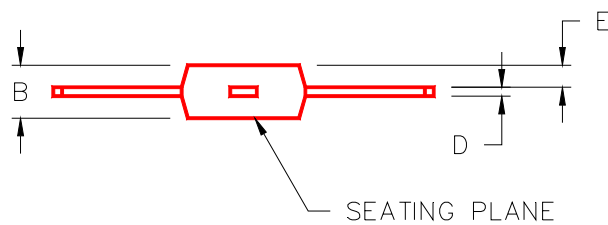

	MINIMUM INCHES/MM	MAXIMUM INCHES/MM		MINIMUM INCHES/MM	MAXIMUM INCHES/MM
A	.175/4,45	.205/5,21			
B	.075/1,91	.100/2,54			
C	.033/0,84	.039/0,99			
D	.008/0,20	.012/0,31			
E	.030/0,76	.045/1,14			
F	.285/7,24	.320/8,13			
G	.415/10,54	.450/11,43			
H	.065/1,65				