

Replaced by MRF5S19060NR1/NBR1. There are no form, fit or function changes with this part replacement. N suffix added to part number to indicate transition to lead-free terminations.

## RF Power Field Effect Transistors

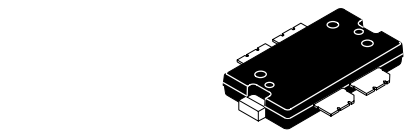
### N-Channel Enhancement-Mode Lateral MOSFETs

Designed for broadband commercial and industrial applications with frequencies from 1930 to 1990 MHz. The high gain and broadband performance of these devices make them ideal for large-signal, common-source amplifier applications in 28 Volt base station equipment.

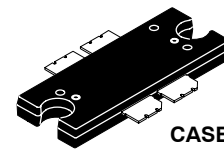
- Typical 2-carrier N-CDMA Performance:  $V_{DD} = 28$  Volts,  $I_{DQ} = 750$  mA,  $P_{out} = 12$  Watts Avg., Full Frequency Band. IS-95 (Pilot, Sync, Paging, Traffic Codes 8 Through 13) Channel Bandwidth = 1.2288 MHz. PAR = 9.8 dB @ 0.01% Probability on CCDF.  
 Power Gain — 14 dB  
 Drain Efficiency — 23%  
 IM3 @ 2.5 MHz Offset — -37 dBc in 1.2288 MHz Channel Bandwidth  
 ACPR @ 885 kHz Offset — -51 dBc in 30 kHz Channel Bandwidth
- Capable of Handling 5:1 VSWR, @ 28 Vdc, 1990 MHz, 12 Watts Avg. Output Power
- Characterized with Series Equivalent Large-Signal Impedance Parameters
- Internally Matched for Ease of Use
- Integrated ESD Protection
- 200°C Capable Plastic Package
- In Tape and Reel. R1 Suffix = 500 Units per 44 mm, 13 inch Reel.

**MRF5S19060MR1**  
**MRF5S19060MBR1**

**1990 MHz, 12 W AVG., 28 V**  
**2 x N-CDMA**  
**LATERAL N-CHANNEL**  
**RF POWER MOSFETs**



**CASE 1486-03, STYLE 1**  
**TO-270 WB-4**  
**PLASTIC**  
**MRF5S19060MR1**



**CASE 1484-04, STYLE 1**  
**TO-272 WB-4**  
**PLASTIC**  
**MRF5S19060MBR1**

**Table 1. Maximum Ratings**

Rating	Symbol	Value	Unit
Drain-Source Voltage	$V_{DSS}$	-0.5, +65	Vdc
Gate-Source Voltage	$V_{GS}$	-0.5, +15	Vdc
Total Device Dissipation @ $T_C = 25^\circ\text{C}$ Derate above 25°C	$P_D$	218.8 1.25	W W/°C
Storage Temperature Range	$T_{stg}$	-65 to +175	°C
Operating Junction Temperature	$T_J$	200	°C

**Table 2. Thermal Characteristics**

Characteristic	Symbol	Value <sup>(1)</sup>	Unit
Thermal Resistance, Junction to Case Case Temperature 75°C, 12 W CW	$R_{\theta JC}$	0.80	°C/W

1. Refer to AN1955, *Thermal Measurement Methodology of RF Power Amplifiers*. Go to <http://www.freescale.com/rt>.  
 Select Documentation/Application Notes - AN1955.

**NOTE - CAUTION** - MOS devices are susceptible to damage from electrostatic charge. Reasonable precautions in handling and packaging MOS devices should be observed.

ARCHIVE INFORMATION

ARCHIVE INFORMATION

**Table 3. ESD Protection Characteristics**

Test Methodology	Class
Human Body Model (per JESD22-A114)	1C (Minimum)
Machine Model (per EIA/JESD22-A115)	C (Minimum)
Charge Device Model (per JESD22-C101)	IV (Minimum)

**Table 4. Moisture Sensitivity Level**

Test Methodology	Rating	Package Peak Temperature	Unit
Per JESD 22-A113, IPC/JEDEC J-STD-020	3	260	°C

**Table 5. Electrical Characteristics** ( $T_C = 25^\circ\text{C}$  unless otherwise noted)

Characteristic	Symbol	Min	Typ	Max	Unit
----------------	--------	-----	-----	-----	------

**Off Characteristics**

Zero Gate Voltage Drain Leakage Current ( $V_{DS} = 65\text{ Vdc}$ , $V_{GS} = 0\text{ Vdc}$ )	$I_{DSS}$	—	—	10	$\mu\text{Adc}$
Zero Gate Voltage Drain Leakage Current ( $V_{DS} = 28\text{ Vdc}$ , $V_{GS} = 0\text{ Vdc}$ )	$I_{DSS}$	—	—	1	$\mu\text{Adc}$
Gate-Source Leakage Current ( $V_{GS} = 5\text{ Vdc}$ , $V_{DS} = 0\text{ Vdc}$ )	$I_{GSS}$	—	—	1	$\mu\text{Adc}$

**On Characteristics**

Gate Threshold Voltage ( $V_{DS} = 10\text{ Vdc}$ , $I_D = 225\ \mu\text{Adc}$ )	$V_{GS(th)}$	2.5	—	3.5	Vdc
Gate Quiescent Voltage ( $V_{DS} = 28\text{ Vdc}$ , $I_D = 750\text{ mAdc}$ )	$V_{GS(Q)}$	—	3.8	—	Vdc
Drain-Source On-Voltage ( $V_{GS} = 5\text{ Vdc}$ , $I_D = 2.25\text{ Adc}$ )	$V_{DS(on)}$	—	0.26	—	Vdc
Forward Transconductance ( $V_{DS} = 10\text{ Vdc}$ , $I_D = 2.25\text{ Adc}$ )	$g_{fs}$	—	5	—	S

**Dynamic Characteristics** <sup>(1)</sup>

Reverse Transfer Capacitance ( $V_{DS} = 28\text{ Vdc} \pm 30\text{ mV(rms)ac}$ @ 1 MHz, $V_{GS} = 0\text{ Vdc}$ )	$C_{rss}$	—	1.5	—	pF
---	-----------	---	-----	---	----

**Functional Tests** (In Freescale Test Fixture, 50 ohm system)  $V_{DD} = 28\text{ Vdc}$ ,  $I_{DQ} = 750\text{ mA}$ ,  $P_{out} = 12\text{ W Avg.}$ ,  $f_1 = 1930\text{ MHz}$ ,  $f_2 = 1932.5\text{ MHz}$  and  $f_1 = 1987.5\text{ MHz}$ ,  $f_2 = 1990\text{ MHz}$ , 2-carrier N-CDMA, 1.2288 MHz Channel Bandwidth Carriers. ACPR measured in 30 kHz Channel Bandwidth @  $\pm 885\text{ kHz}$  Offset. IM3 measured in 1.2288 MHz Channel Bandwidth @  $\pm 2.5\text{ MHz}$  Offset. PAR = 9.8 dB @ 0.01% Probability on CCDF.

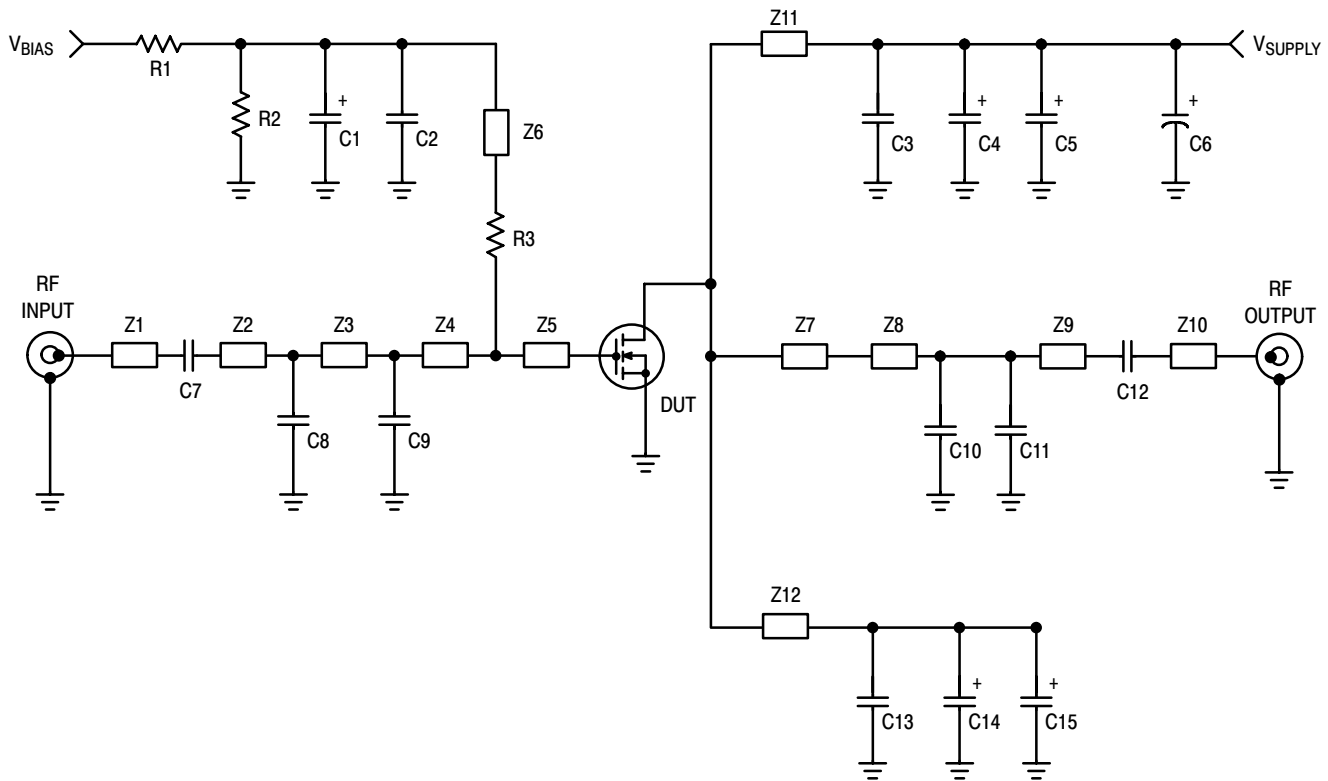
Power Gain	$G_{ps}$	12.5	14	16	dB
Drain Efficiency	$\eta_D$	21	23	—	%
Intermodulation Distortion	IM3	—	-37	-35	dBc
Adjacent Channel Power Ratio	ACPR	—	-51	-48	dBc
Input Return Loss	IRL	—	-12	-9	dB

1. Part is internally matched both on input and output.

(continued)

**Table 5. Electrical Characteristics** ( $T_C = 25^\circ\text{C}$  unless otherwise noted) (continued)

Characteristic	Symbol	Min	Typ	Max	Unit
<b>Typical RF Performance</b> (50 ohm system)					
Pulse Peak Power ( $V_{DD} = 28\text{ Vdc}$ , 1-Tone CW Pulsed, $I_{DQ} = 750\text{ mA}$ , $t_{ON} = 8\ \mu\text{s}$ , 1% Duty Cycle)	$P_{\text{sat}}$	—	110	—	W
Video Bandwidth ( $V_{DD} = 28\text{ Vdc}$ , $P_{\text{out}} = 60\text{ W PEP}$ , $I_{DQ} = 750\text{ mA}$ , Tone Spacing = 1 MHz to VBW, $\Delta\text{IM3} < 2\text{dB}$ )	VBW	—	35	—	MHz

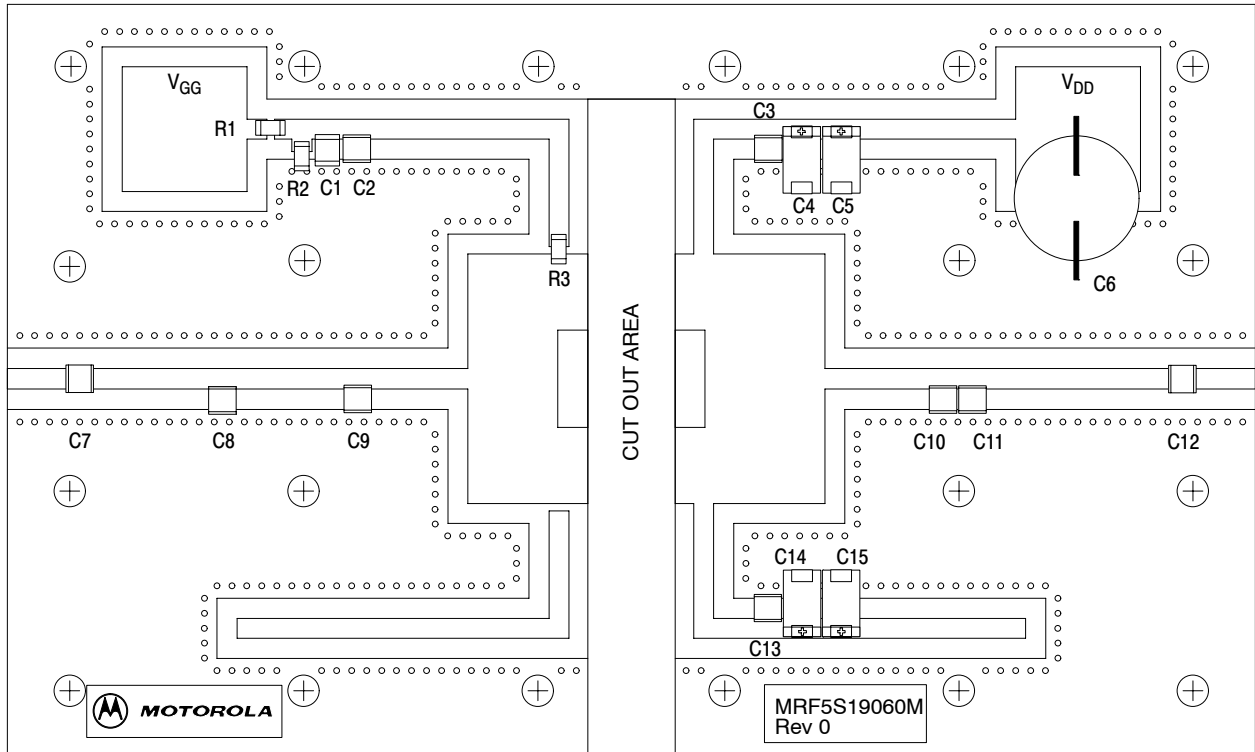


- |     |                            |     |  |
|-----|----------------------------|-----|--|
| Z1  | 0.250" x 0.083" Microstrip | Z8* | 0.420" x 0.083" Microstrip                     |
| Z2* | 0.500" x 0.083" Microstrip | Z9* | 0.975" x 0.083" Microstrip                     |
| Z3* | 0.500" x 0.083" Microstrip | Z10 | 0.250" x 0.083" Microstrip                     |
| Z4* | 0.515" x 0.083" Microstrip | Z11 | 0.700" x 0.080" Microstrip                     |
| Z5  | 0.480" x 1.000" Microstrip | Z12 | 0.700" x 0.080" Microstrip                     |
| Z6  | 1.140" x 0.080" Microstrip | PCB | Taconic TLX8-0300, 0.030", $\epsilon_r = 2.55$ |
| Z7  | 0.600" x 1.000" Microstrip |     |  |
- \* Variable for tuning

**Figure 1. MRF5S19060MR1/MBR1 Test Circuit Schematic**

**Table 6. MRF5S19060MR1/MBR1 Test Circuit Component Designations and Values**

Part	Description	Part Number	Manufacturer
C1	1 $\mu$ F, 35 V Tantalum Capacitor	TAJB105K35	AVX
C2	10 pF 100B Chip Capacitor	100B10R0CW	ATC
C3, C7, C12, C13	6.8 pF 100B Chip Capacitors	100B6R8CW	ATC
C4, C5, C14, C15	10 $\mu$ F, 35 V Tantalum Capacitors	TAJD106K035	AVX
C6	220 $\mu$ F, 63 V Electrolytic Capacitor, Radial	13668221	Philips
C8	0.8 pF 100B Chip Capacitor	100B0R8BW	ATC
C9	1.5 pF 100B Chip Capacitor	100B1R5BW	ATC
C10	1.0 pF 100B Chip Capacitor	100B1R0BW	ATC
C11	0.2 pF 100B Chip Capacitor	100B0R2BW	ATC
R1, R2	10 k $\Omega$ , 1/4 W Chip Resistors (1206)		
R3	10 $\Omega$ , 1/4 W Chip Resistors (1206)		



Freescale has begun the transition of marking Printed Circuit Boards (PCBs) with the Freescale Semiconductor signature/logo. PCBs may have either Motorola or Freescale markings during the transition period. These changes will have no impact on form, fit or function of the current product.

**Figure 2. MRF5S19060MR1/MBR1 Test Circuit Component Layout**

TYPICAL CHARACTERISTICS

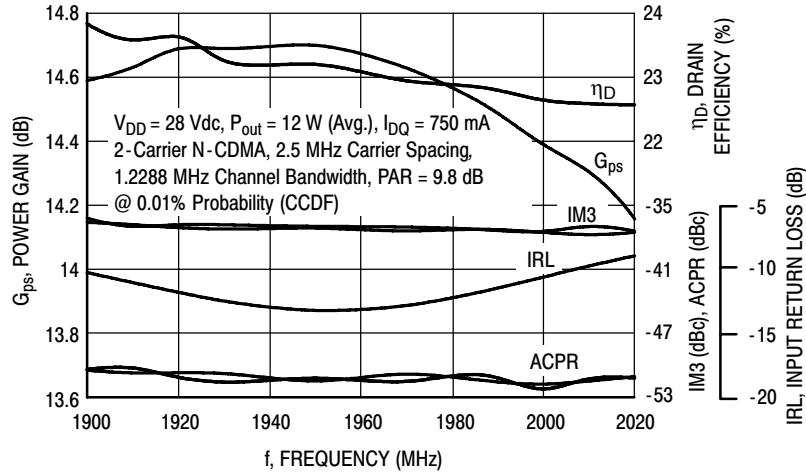


Figure 3. 2-Carrier N-CDMA Broadband Performance @  $P_{out} = 12$  Watts Avg.

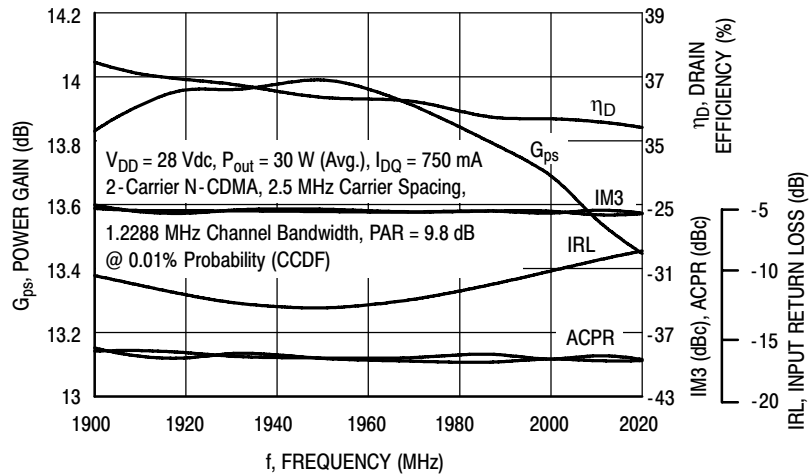


Figure 4. 2-Carrier N-CDMA Broadband Performance @  $P_{out} = 30$  Watts Avg.

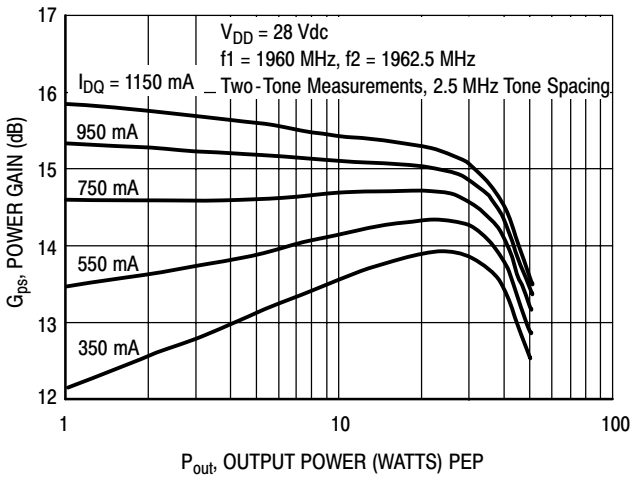


Figure 5. Two-Tone Power Gain versus Output Power

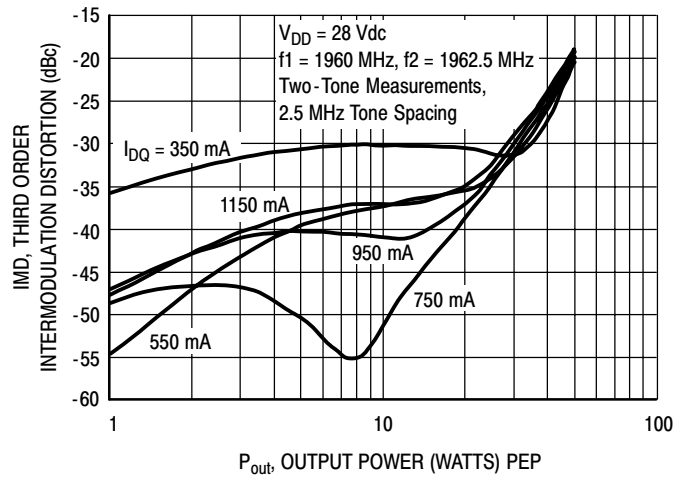


Figure 6. Third Order Intermodulation Distortion versus Output Power

## TYPICAL CHARACTERISTICS

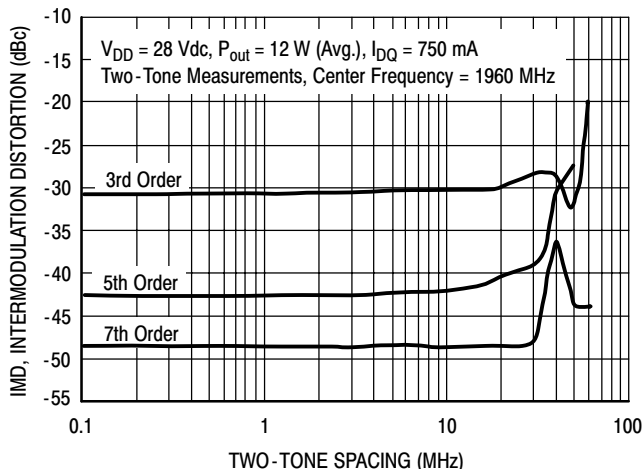


Figure 7. Intermodulation Distortion Products versus Tone Spacing

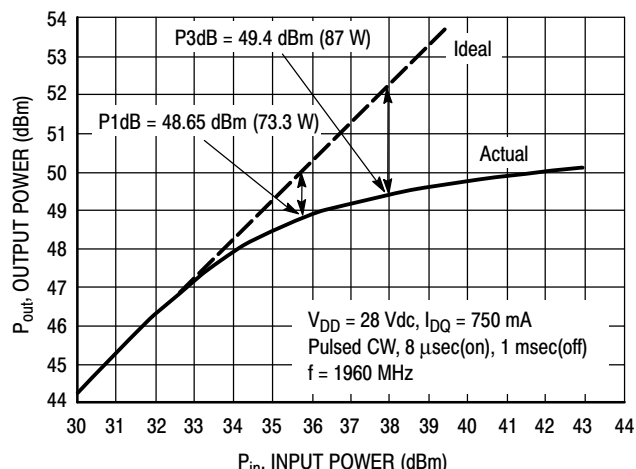


Figure 8. Pulse CW Output Power versus Input Power

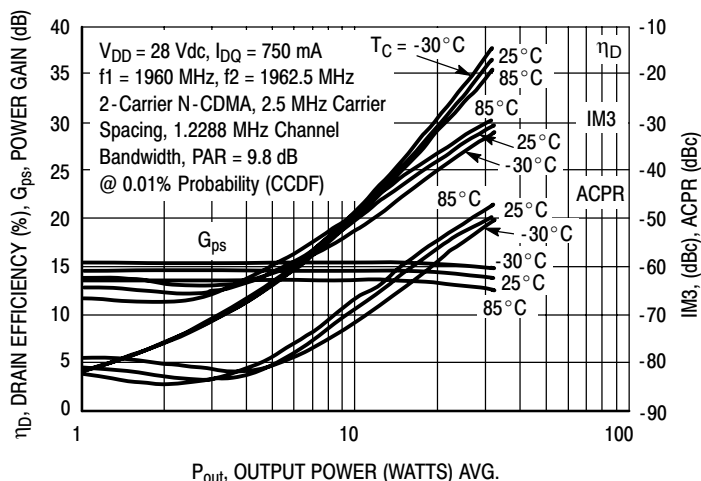


Figure 9. 2-Carrier N-CDMA ACPR, IM3, Power Gain and Drain Efficiency versus Output Power

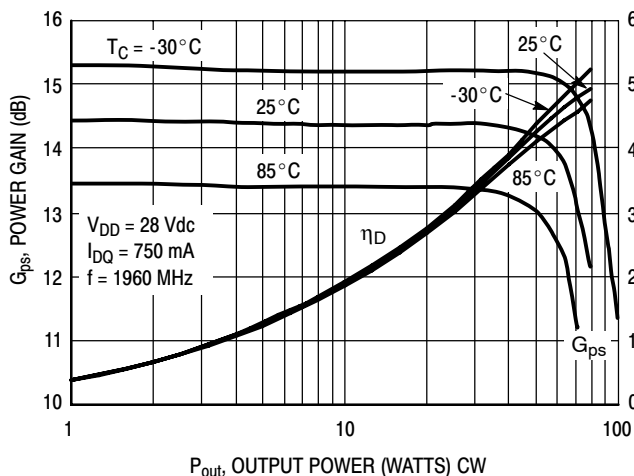


Figure 10. Power Gain and Drain Efficiency versus CW Output Power

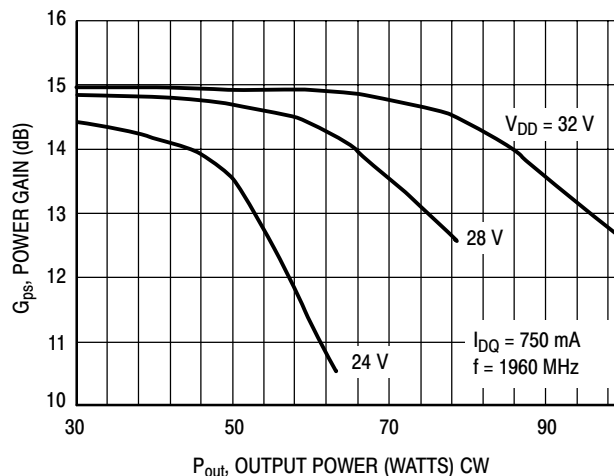
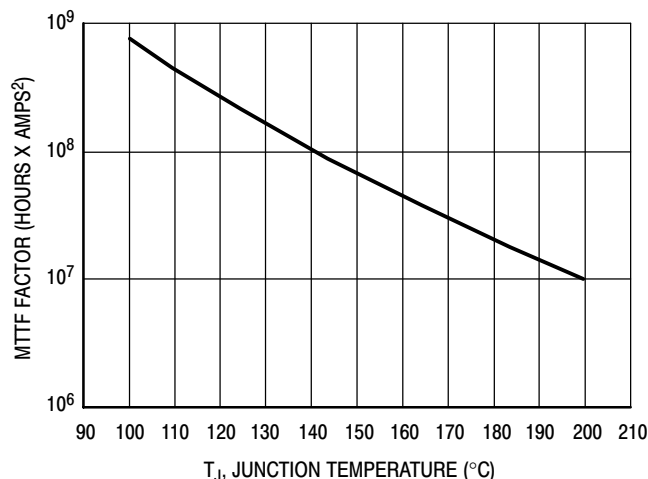


Figure 11. Power Gain versus Output Power

MRF5S19060MR1 MRF5S19060MBR1

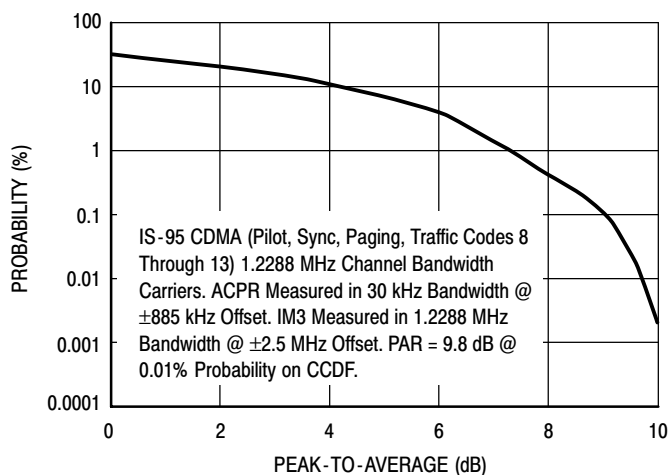
## TYPICAL CHARACTERISTICS



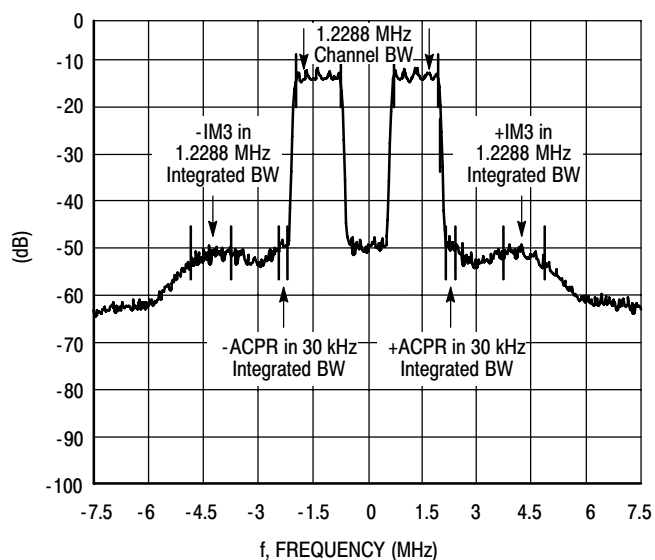
This above graph displays calculated MTTF in hours x ampere<sup>2</sup> drain current. Life tests at elevated temperatures have correlated to better than  $\pm 10\%$  of the theoretical prediction for metal failure. Divide MTTF factor by  $I_D^2$  for MTTF in a particular application.

**Figure 12. MTTF Factor versus Junction Temperature**

## N-CDMA TEST SIGNAL

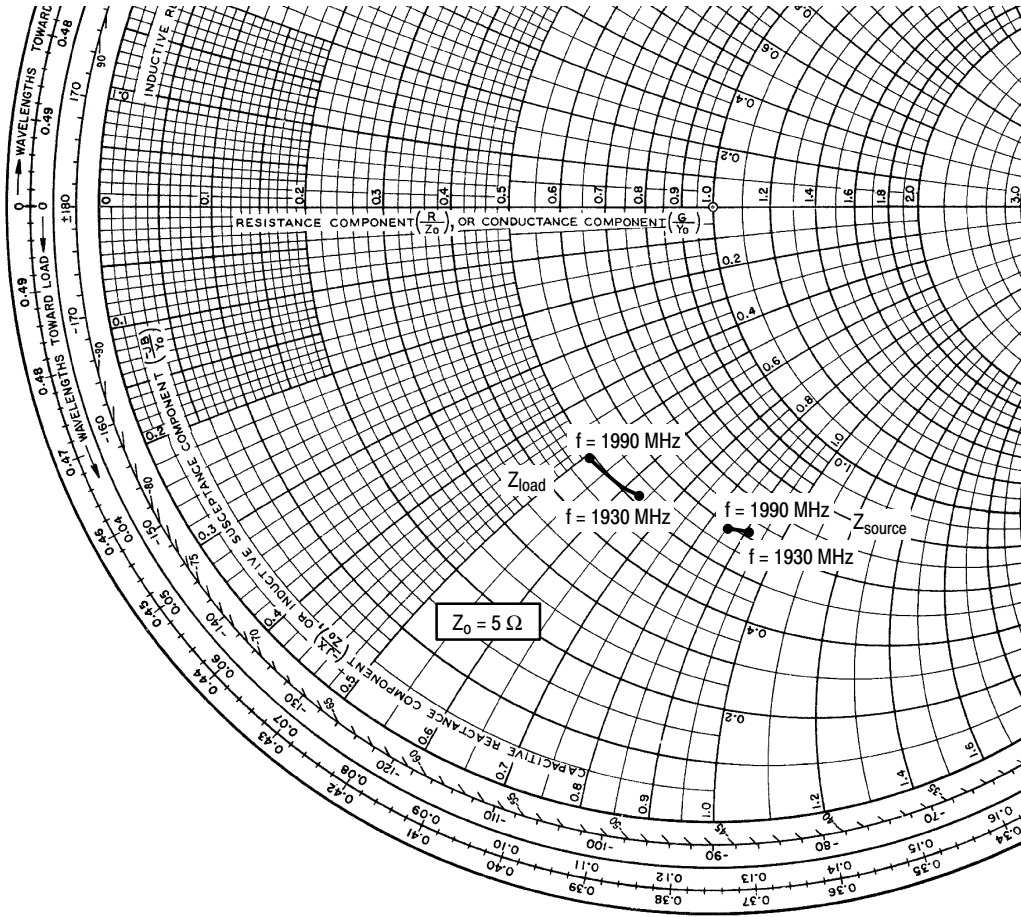


**Figure 13. 2-Carrier CCDF N-CDMA**



**Figure 14. 2-Carrier N-CDMA Spectrum**





$V_{DD} = 28 \text{ Vdc}$ ,  $I_{DQ} = 750 \text{ mA}$ ,  $P_{out} = 12 \text{ W Avg.}$

f MHz	Z <sub>source</sub> Ω	Z <sub>load</sub> Ω
1930	3.11 - j4.55	2.60 - j3.18
1960	3.06 - j4.38	2.50 - j2.85
1990	2.93 - j4.28	2.44 - j2.53

Z<sub>source</sub> = Test circuit impedance as measured from gate to ground.

Z<sub>load</sub> = Test circuit impedance as measured from drain to ground.

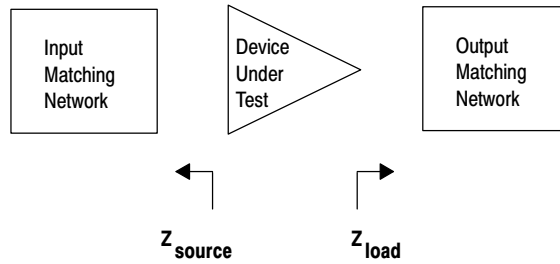


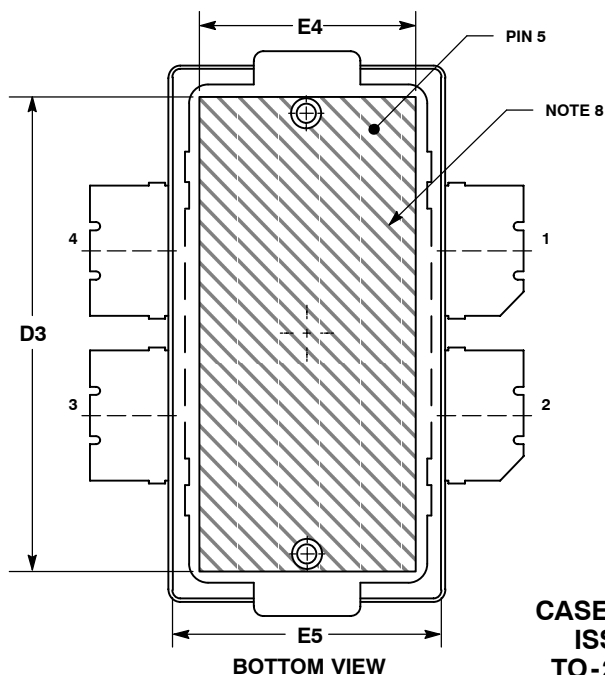
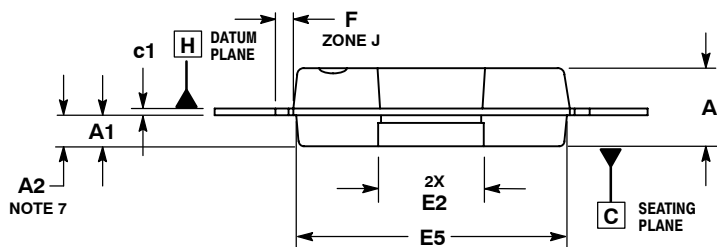
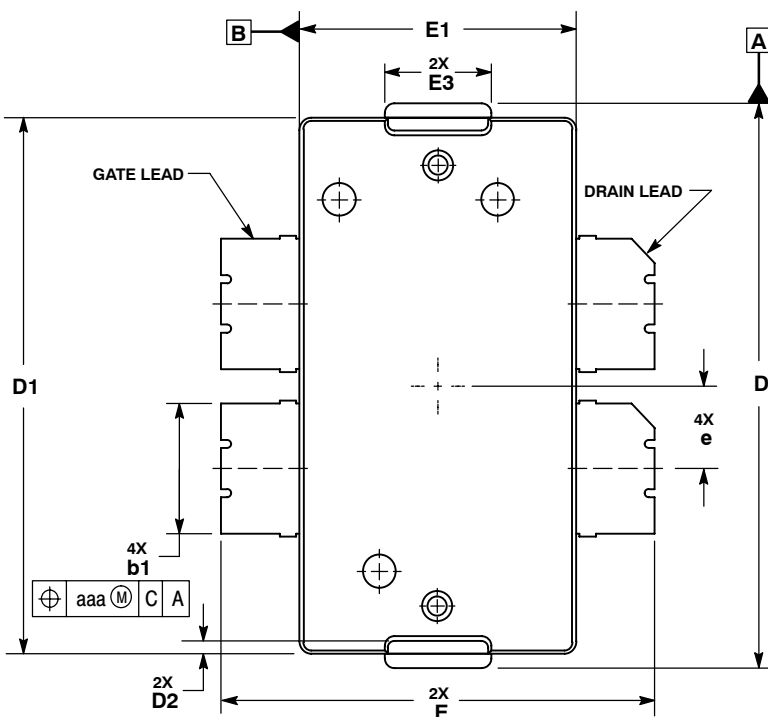
Figure 15. Series Equivalent Source and Load Impedance

# NOTES



# NOTES

# PACKAGE DIMENSIONS



**NOTES:**

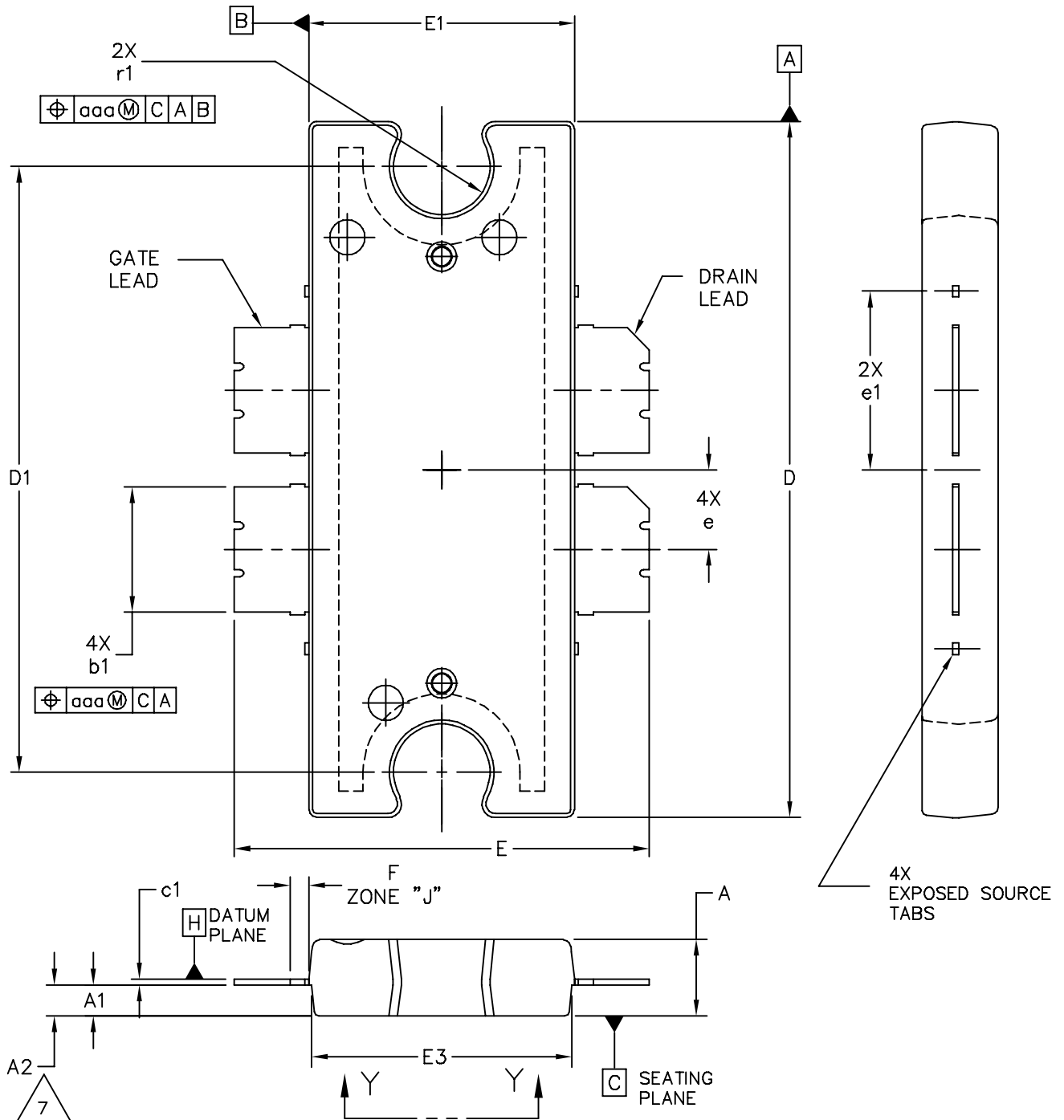
1. CONTROLLING DIMENSION: INCH.
2. INTERPRET DIMENSIONS AND TOLERANCES PER ASME Y14.5M-1994.
3. DATUM PLANE -H- IS LOCATED AT THE TOP OF LEAD AND IS COINCIDENT WITH THE LEAD WHERE THE LEAD EXITS THE PLASTIC BODY AT THE TOP OF THE PARTING LINE.
4. DIMENSIONS "D" AND "E1" DO NOT INCLUDE MOLD PROTRUSION. ALLOWABLE PROTRUSION IS .006 PER SIDE. DIMENSIONS "D" AND "E1" DO INCLUDE MOLD MISMATCH AND ARE DETERMINED AT DATUM PLANE -H-.
5. DIMENSION "b1" DOES NOT INCLUDE DAMBAR PROTRUSION. ALLOWABLE DAMBAR PROTRUSION SHALL BE .005 TOTAL IN EXCESS OF THE "b1" DIMENSION AT MAXIMUM MATERIAL CONDITION.
6. DATUMS -A- AND -B- TO BE DETERMINED AT DATUM PLANE -H-.
7. DIMENSION A2 APPLIES WITHIN ZONE "J" ONLY.
8. HATCHING REPRESENTS THE EXPOSED AREA OF THE HEAT SLUG.

DIM	INCHES		MILLIMETERS	
	MIN	MAX	MIN	MAX
A	.100	.104	2.54	2.64
A1	.039	.043	0.99	1.09
A2	.040	.042	1.02	1.07
D	.712	.720	18.08	18.29
D1	.688	.692	17.48	17.58
D2	.011	.019	0.28	0.48
D3	.600	---	15.24	---
E	.551	.559	14	14.2
E1	.353	.357	8.97	9.07
E2	.132	.140	3.35	3.56
E3	.124	.132	3.15	3.35
E4	.270	---	6.86	---
E5	.346	.350	8.79	8.89
F	.025 BSC		0.64 BSC	
b1	.164	.170	4.17	4.32
c1	.007	.011	0.18	0.28
e	.106 BSC		2.69 BSC	
aaa	.004		0.10	

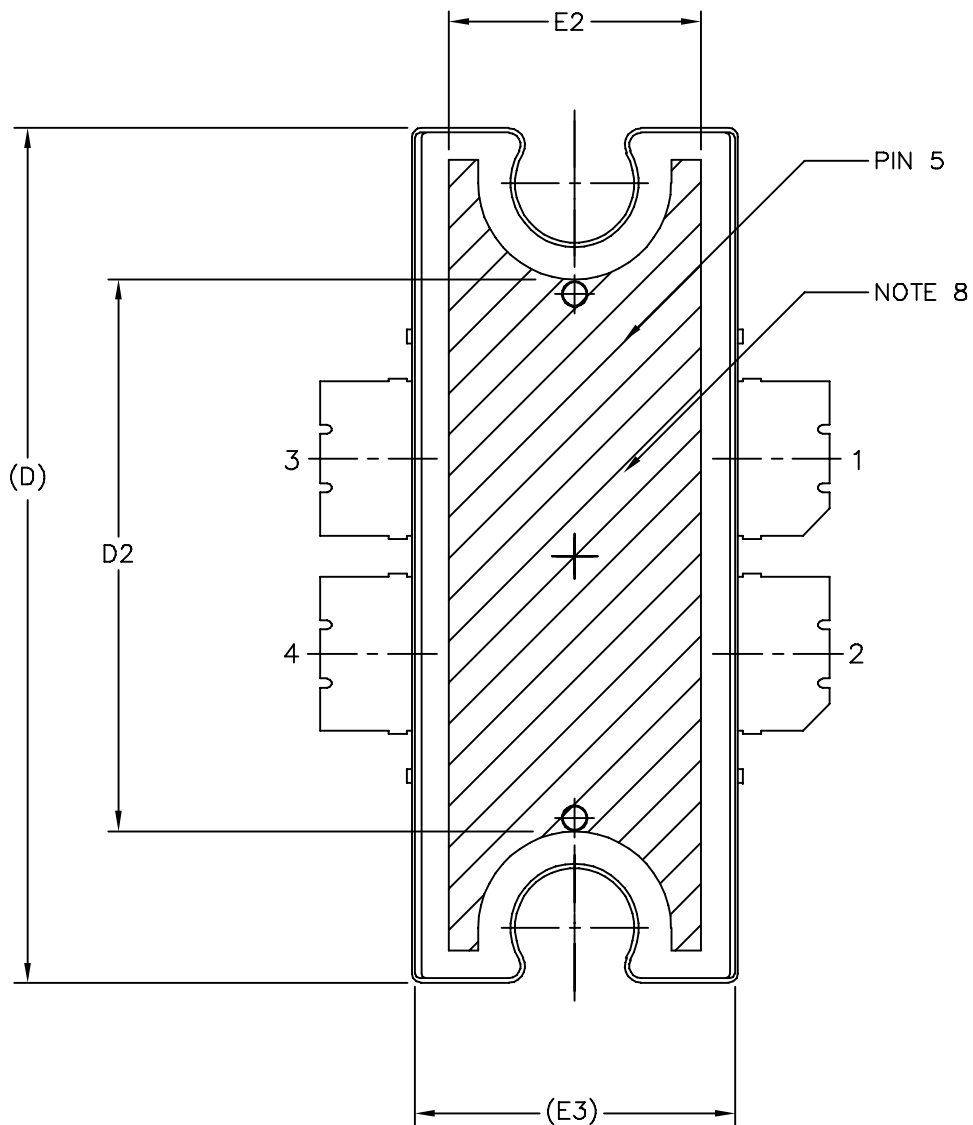
**STYLE 1:**

- PIN 1. DRAIN
- DRAIN
- GATE
- GATE
- SOURCE

**CASE 1486-03  
ISSUE C  
TO-270 WB-4  
PLASTIC  
MRF5S19060MR1**



© FREESCALE SEMICONDUCTOR, INC. ALL RIGHTS RESERVED.		<b>MECHANICAL OUTLINE</b>		PRINT VERSION NOT TO SCALE	
TITLE:  TO-272 4 LEAD, WIDE BODY			DOCUMENT NO: 98ASA10575D		REV: D
			CASE NUMBER: 1484-04		05 APR 2006
			STANDARD: NON-JEDEC		



© FREESCALE SEMICONDUCTOR, INC. ALL RIGHTS RESERVED.	<b>MECHANICAL OUTLINE</b>	PRINT VERSION NOT TO SCALE	
TITLE: TO-272 4 LEAD, WIDE BODY	DOCUMENT NO: 98ASA10575D	REV: D	
	CASE NUMBER: 1484-04	05 APR 2006	
	STANDARD: NON-JEDEC		

NOTES:

1. CONTROLLING DIMENSION: INCH
2. INTERPRET DIMENSIONS AND TOLERANCES PER ASME Y14.5M-1994.
3. DATUM PLANE H IS LOCATED AT THE TOP OF LEAD AND IS COINCIDENT WITH THE LEAD WHERE THE LEAD EXITS THE PLASTIC BODY AT THE TOP OF THE PARTING LINE.
4. DIMENSIONS "D" AND "E1" DO NOT INCLUDE MOLD PROTRUSION. ALLOWABLE PROTRUSION IS .006 PER SIDE. DIMENSIONS "D" AND "E1" DO INCLUDE MOLD MISMATCH AND ARE DETERMINED AT DATUM PLANE H.
5. DIMENSIONS "b1" DOES NOT INCLUDE DAMBAR PROTRUSION. ALLOWABLE DAMBAR PROTRUSION SHALL BE .005 TOTAL IN EXCESS OF THE "b1" DIMENSION AT MAXIMUM MATERIAL CONDITION.
6. DATUM A AND B TO BE DETERMINED AT DATUM PLANE H.
7. DIMENSION A2 APPLIES WITHIN ZONE "J" ONLY.
8. HATCHING REPRESENTS EXPOSED AREA OF THE HEAT SLUG. HATCHED AREA SHOWN IS ON THE SAME PLANE.

STYLE 1:

PIN 1 - DRAIN      PIN 2 - DRAIN  
 PIN 3 - GATE      PIN 4 - GATE  
 PIN 5 - SOURCE

DIM	INCH		MILLIMETER		DIM	INCH		MILLIMETER	
	MIN	MAX	MIN	MAX		MIN	MAX	MIN	MAX
A	.100	.104	2.54	2.64	b1	.164	.170	4.17	4.32
A1	.039	.043	0.99	1.09	c1	.007	.011	.18	.28
A2	.040	.042	1.02	1.07	r1	.063	.068	1.60	1.73
D	.928	.932	23.57	23.67	e	.106 BSC		2.69 BSC	
D1	.810 BSC		20.57 BSC		e1	.239 INFO ONLY		6.07 INFO ONLY	
D2	.600	---	15.24	---	aaa	.004		.10	
E	.551	.559	14	14.2					
E1	.353	.357	8.97	9.07					
E2	.270	---	6.86	---					
E3	.346	.350	8.79	8.89					
F	.025 BSC		0.64 BSC						

© FREESCALE SEMICONDUCTOR, INC.  
 ALL RIGHTS RESERVED.

**MECHANICAL OUTLINE**

PRINT VERSION NOT TO SCALE

TITLE:

TO-272  
 4 LEAD WIDE BODY

DOCUMENT NO: 98ASA10575D

REV: D

CASE NUMBER: 1484-04

05 APR 2006

STANDARD: NON-JEDEC

## **How to Reach Us:**

### **Home Page:**

[www.freescale.com](http://www.freescale.com)

### **E-mail:**

[support@freescale.com](mailto:support@freescale.com)

### **USA/Europe or Locations Not Listed:**

Freescale Semiconductor  
Technical Information Center, CH370  
1300 N. Alma School Road  
Chandler, Arizona 85224  
+1-800-521-6274 or +1-480-768-2130  
[support@freescale.com](mailto:support@freescale.com)

### **Europe, Middle East, and Africa:**

Freescale Halbleiter Deutschland GmbH  
Technical Information Center  
Schatzbogen 7  
81829 Muenchen, Germany  
+44 1296 380 456 (English)  
+46 8 52200080 (English)  
+49 89 92103 559 (German)  
+33 1 69 35 48 48 (French)  
[support@freescale.com](mailto:support@freescale.com)

### **Japan:**

Freescale Semiconductor Japan Ltd.  
Headquarters  
ARCO Tower 15F  
1-8-1, Shimo-Meguro, Meguro-ku,  
Tokyo 153-0064  
Japan  
0120 191014 or +81 3 5437 9125  
[support.japan@freescale.com](mailto:support.japan@freescale.com)

### **Asia/Pacific:**

Freescale Semiconductor Hong Kong Ltd.  
Technical Information Center  
2 Dai King Street  
Tai Po Industrial Estate  
Tai Po, N.T., Hong Kong  
+800 2666 8080  
[support.asia@freescale.com](mailto:support.asia@freescale.com)

### **For Literature Requests Only:**

Freescale Semiconductor Literature Distribution Center  
P.O. Box 5405  
Denver, Colorado 80217  
1-800-441-2447 or 303-675-2140  
Fax: 303-675-2150  
[LDCForFreescaleSemiconductor@hibbertgroup.com](mailto:LDCForFreescaleSemiconductor@hibbertgroup.com)

Information in this document is provided solely to enable system and software implementers to use Freescale Semiconductor products. There are no express or implied copyright licenses granted hereunder to design or fabricate any integrated circuits or integrated circuits based on the information in this document.

Freescale Semiconductor reserves the right to make changes without further notice to any products herein. Freescale Semiconductor makes no warranty, representation or guarantee regarding the suitability of its products for any particular purpose, nor does Freescale Semiconductor assume any liability arising out of the application or use of any product or circuit, and specifically disclaims any and all liability, including without limitation consequential or incidental damages. "Typical" parameters that may be provided in Freescale Semiconductor data sheets and/or specifications can and do vary in different applications and actual performance may vary over time. All operating parameters, including "Typicals", must be validated for each customer application by customer's technical experts. Freescale Semiconductor does not convey any license under its patent rights nor the rights of others. Freescale Semiconductor products are not designed, intended, or authorized for use as components in systems intended for surgical implant into the body, or other applications intended to support or sustain life, or for any other application in which the failure of the Freescale Semiconductor product could create a situation where personal injury or death may occur. Should Buyer purchase or use Freescale Semiconductor products for any such unintended or unauthorized application, Buyer shall indemnify and hold Freescale Semiconductor and its officers, employees, subsidiaries, affiliates, and distributors harmless against all claims, costs, damages, and expenses, and reasonable attorney fees arising out of, directly or indirectly, any claim of personal injury or death associated with such unintended or unauthorized use, even if such claim alleges that Freescale Semiconductor was negligent regarding the design or manufacture of the part.

Freescale™ and the Freescale logo are trademarks of Freescale Semiconductor, Inc. All other product or service names are the property of their respective owners.  
© Freescale Semiconductor, Inc. 2006. All rights reserved.

RoHS-compliant and/or Pb-free versions of Freescale products have the functionality and electrical characteristics of their non-RoHS-compliant and/or non-Pb-free counterparts. For further information, see <http://www.freescale.com> or contact your Freescale sales representative.

For information on Freescale's Environmental Products program, go to <http://www.freescale.com/epp>.

