

MRF5S19150R3 and MRF5S19150SR3 replaced by MRF5S19150HR3 and MRF5S19150HSR3. "H" suffix indicates lower thermal resistance package.

The RF MOSFET Line
RF Power Field Effect Transistors
N-Channel Enhancement-Mode Lateral MOSFETs

MRF5S19150R3
MRF5S19150SR3

Designed for PCN and PCS base station applications at frequencies from 1.9 to 2.0 GHz. Suitable for TDMA, CDMA and multicarrier amplifier applications.

1990 MHz, 32 W, 28 V
LATERAL N-CHANNEL
RF POWER MOSFETs

- Typical 2-Carrier N-CDMA Performance for $V_{DD} = 28$ Volts,
 $P_{out} = 32$ Watts, $I_{DQ} = 1400$ mA, $f_1 = 1958.75$ MHz, $f_2 = 1961.25$ MHz
 IS-95 CDMA (Pilot, Sync, Paging, Traffic Codes 8 Through 13)
 1.2288 MHz Channel Bandwidth Carrier. Adjacent Channels Measured
 over a 30 kHz Bandwidth at $f_1 - 885$ kHz and $f_2 + 885$ kHz. Distortion
 Products Measured over 1.2288 MHz Bandwidth at $f_1 - 2.5$ MHz and
 $f_2 + 2.5$ MHz. Peak/Avg. = 9.8 dB @ 0.01% Probability on CCDF.
 Output Power — 32 Watts Avg.
 Power Gain — 14 dB
 Efficiency — 26%
 ACPR — -50 dB
 IM3 — -36.5 dBc

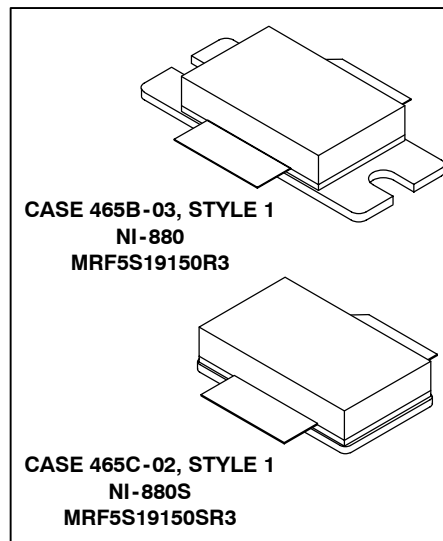

- Internally Matched, Controlled Q, for Ease of Use
- High Gain, High Efficiency and High Linearity
- Integrated ESD Protection
- Designed for Maximum Gain and Insertion Phase Flatness
- Capable of Handling 5:1 VSWR, @ 28 Vdc, $f_1 = 1960$ MHz, 100 Watts CW Output Power
- Excellent Thermal Stability
- Qualified Up to a Maximum of 32 V Operation
- In Tape and Reel. R3 Suffix = 250 Units per 56 mm, 13 inch Reel.

MAXIMUM RATINGS

Rating	Symbol	Value	Unit
Drain-Source Voltage	V_{DSS}	65	Vdc
Gate-Source Voltage	V_{GS}	-0.5, +15	Vdc
Total Device Dissipation @ $T_C = 25^\circ\text{C}$ Derate above 25°C	P_D	357 2	Watts W/ $^\circ\text{C}$
Storage Temperature Range	T_{stg}	- 65 to +150	$^\circ\text{C}$
Operating Junction Temperature	T_J	200	$^\circ\text{C}$
CW Operation	CW	100	Watts

THERMAL CHARACTERISTICS

Characteristic	Symbol	Value (1,2)	Unit
Thermal Resistance, Junction to Case Case Temperature 80°C , 100 W CW Case Temperature 80°C , 32 W CW	$R_{\theta JC}$	0.49 0.53	$^\circ\text{C}/\text{W}$

- (1) MTTF calculator available at <http://www.motorola.com/semiconductors/rf>. Select Tools/Software/Application Software/Calculators to access the MTTF calculators by product.
- (2) Refer to AN1955/D, *Thermal Measurement Methodology of RF Power Amplifiers*. Go to <http://www.motorola.com/semiconductors/rf>. Select Documentation/Application Notes - AN1955.

NOTE - CAUTION - MOS devices are susceptible to damage from electrostatic charge. Reasonable precautions in handling and packaging MOS devices should be observed.

Freescale Semiconductor, Inc. ARCHIVE INFORMATION

ARCHIVE INFORMATION

Freescale Semiconductor, Inc.

ESD PROTECTION CHARACTERISTICS

Test Conditions	Class
Human Body Model	1 (Minimum)
Machine Model	M3 (Minimum)
Charge Device Model	C7 (Minimum)

ELECTRICAL CHARACTERISTICS (T_C = 25°C unless otherwise noted)

Characteristic	Symbol	Min	Typ	Max	Unit
----------------	--------	-----	-----	-----	------

OFF CHARACTERISTICS

Zero Gate Voltage Drain Leakage Current (V _{DS} = 65 Vdc, V _{GS} = 0 Vdc)	I _{DSS}	—	—	10	μA _{dc}
Zero Gate Voltage Drain Leakage Current (V _{DS} = 28 Vdc, V _{GS} = 0 Vdc)	I _{DSS}	—	—	1	μA _{dc}
Gate-Source Leakage Current (V _{GS} = 5 Vdc, V _{DS} = 0 Vdc)	I _{GSS}	—	—	1	μA _{dc}

ON CHARACTERISTICS

Gate Threshold Voltage (V _{DS} = 10 Vdc, I _D = 360 μA _{dc})	V _{GS(th)}	2.5	2.8	3.5	Vdc
Gate Quiescent Voltage (V _{DS} = 28 Vdc, I _D = 1400 mA _{dc})	V _{GS(Q)}	—	3.8	—	Vdc
Drain-Source On-Voltage (V _{GS} = 10 Vdc, I _D = 3.6 A _{dc})	V _{DS(on)}	—	0.24	—	Vdc
Forward Transconductance (V _{DS} = 10 Vdc, I _D = 3.6 A _{dc})	g _{fs}	—	9	—	S

DYNAMIC CHARACTERISTICS

Reverse Transfer Capacitance (1) (V _{DS} = 28 Vdc, V _{GS} = 0, f = 1 MHz)	C _{r_{ss}}	—	3.1	—	pF
--	-----------------------------	---	-----	---	----

FUNCTIONAL TESTS (In Motorola Test Fixture, 50 ohm system) 2-Carrier N-CDMA, 1.2288 MHz Channel Bandwidth Carriers.
Peak/Avg = 9.8 dB @ 0.01% Probability on CCDF.

Common-Source Amplifier Power Gain (V _{DD} = 28 Vdc, P _{out} = 32 W Avg, I _{DQ} = 1400 mA, f ₁ = 1930 MHz, f ₂ = 1932.5 MHz and f ₁ = 1987.5 MHz, f ₂ = 1990 MHz)	G _{ps}	13	14	—	dB
Drain Efficiency (V _{DD} = 28 Vdc, P _{out} = 32 W Avg, I _{DQ} = 1400 mA, f ₁ = 1930 MHz, f ₂ = 1932.5 MHz and f ₁ = 1987.5 MHz, f ₂ = 1990 MHz)	η	24	26	—	%
Third Order Intermodulation Distortion (V _{DD} = 28 Vdc, P _{out} = 32 W Avg, I _{DQ} = 1400 mA, f ₁ = 1930 MHz, f ₂ = 1932.5 MHz and f ₁ = 1987.5 MHz, f ₂ = 1990 MHz; IM3 measured over 1.2288 MHz Bandwidth at f ₁ -2.5 MHz and f ₂ +2.5 MHz referenced to carrier channel power.)	IM3	—	-36.5	-35	dBc
Adjacent Channel Power Ratio (V _{DD} = 28 Vdc, P _{out} = 32 W Avg, I _{DQ} = 1400 mA, f ₁ = 1930 MHz, f ₂ = 1932.5 MHz and f ₁ = 1987.5 MHz, f ₂ = 1990 MHz; ACPR measured over 30 kHz Bandwidth at f ₁ -885 MHz and f ₂ +885 MHz)	ACPR	—	-50	-48	dBc
Input Return Loss (V _{DD} = 28 Vdc, P _{out} = 32 W Avg, I _{DQ} = 1400 mA, f ₁ = 1930 MHz, f ₂ = 1932.5 MHz and f ₁ = 1987.5 MHz, f ₂ = 1990 MHz)	IRL	—	-17	-9	dB

(1) Part is internally matched both on input and output.

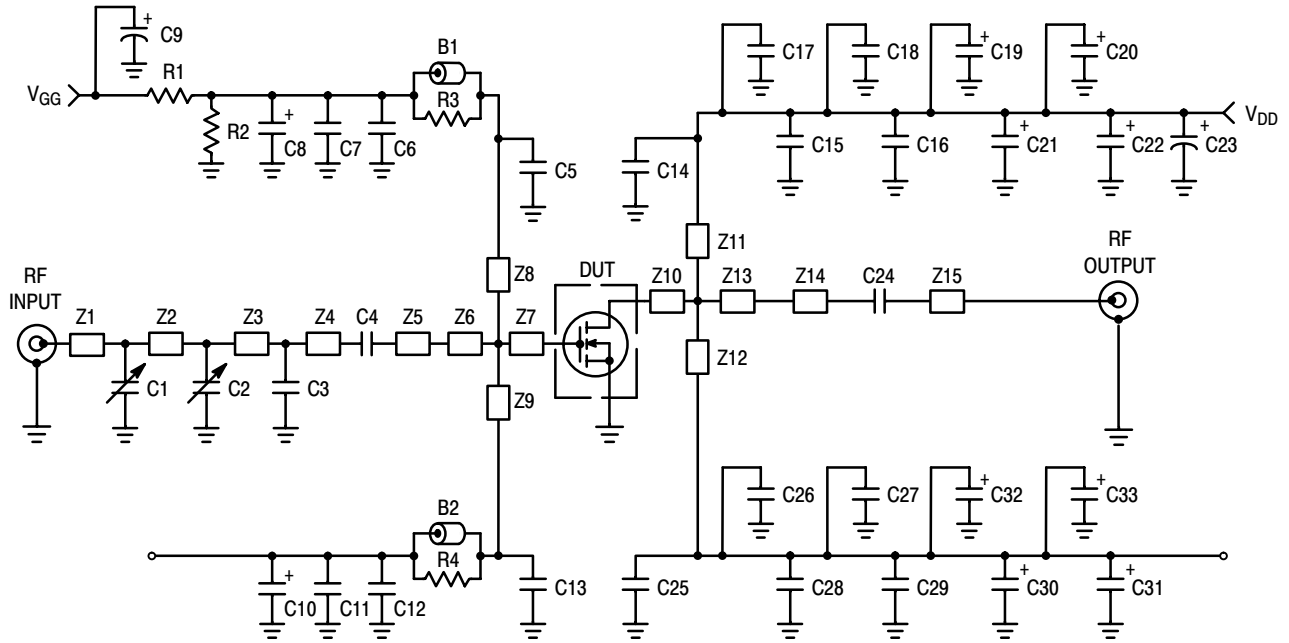

Z1	1.023" x 0.082" Microstrip	Z9	1.280" x 0.046" Microstrip
Z2	0.398" x 0.082" Microstrip	Z10	0.090" x 1.055" Microstrip
Z3	0.203" x 0.082" Microstrip	Z11	1.125" x 0.068" Microstrip
Z4	0.074" x 0.082" Microstrip	Z12	1.125" x 0.068" Microstrip
Z5	0.630" x 0.084" Microstrip	Z13	0.505" x 1.055" Microstrip
Z6	0.557" x 1.030" x 0.237" Microstrip Taper	Z14	0.898" x 0.105" Microstrip
Z7	0.103" x 1.030" Microstrip	Z15	1.133" x 0.082" Microstrip
Z8	1.280" x 0.046" Microstrip	PCB	Arlon GX0300-55-22, 0.03", $\epsilon_r = 2.55$

Figure 1. MRF5S19150 Test Circuit Schematic

Table 1. MRF5S19150 Test Circuit Component Designations and Values

Part	Description
B1, B2	Short RF Beads
C1, C2	0.6 – 4.5 Variable Capacitors, Gigatrim
C3	0.8 pF Chip Capacitor, B Case
C4, C5, C13, C14, C24, C25	9.1 pF Chip Capacitors, B Case
C8, C10	1.0 μ F, 50 V SMT Tantalum Capacitors
C6, C12, C16, C17, C18, C27, C28, C29	0.1 μ F Chip Capacitors, B Case
C7, C11, C15, C26	1000 pF Chip Capacitors, B Case
C9	100 μ F, 50 V Electrolytic Capacitor
C23	470 μ F, 63 V Electrolytic Capacitor
C19, C20, C21, C22, C30, C31, C32, C33	22 μ F, 35 V Tantalum Capacitors
R1	1 k Ω Chip Resistor
R2	560 k Ω Chip Resistor
R3, R4	12 Ω Chip Resistors

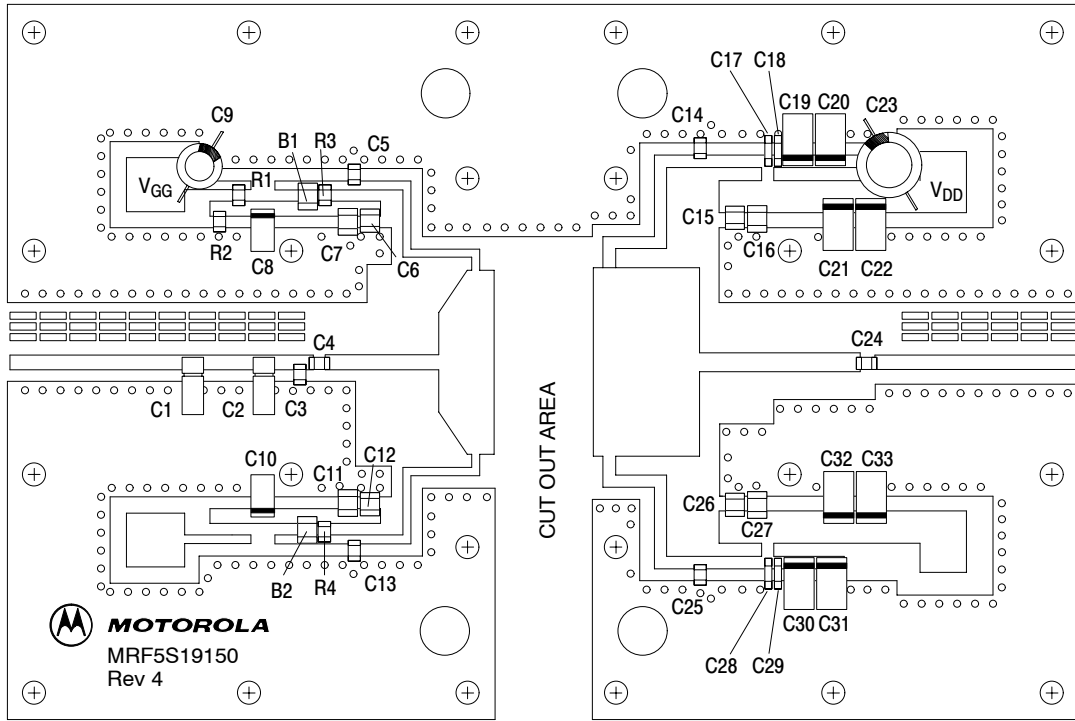

Figure 2. MRF5S19150 Test Circuit Component Layout

ARCHIVE INFORMATION

ARCHIVE INFORMATION

Freescale Semiconductor, Inc.

TYPICAL CHARACTERISTICS

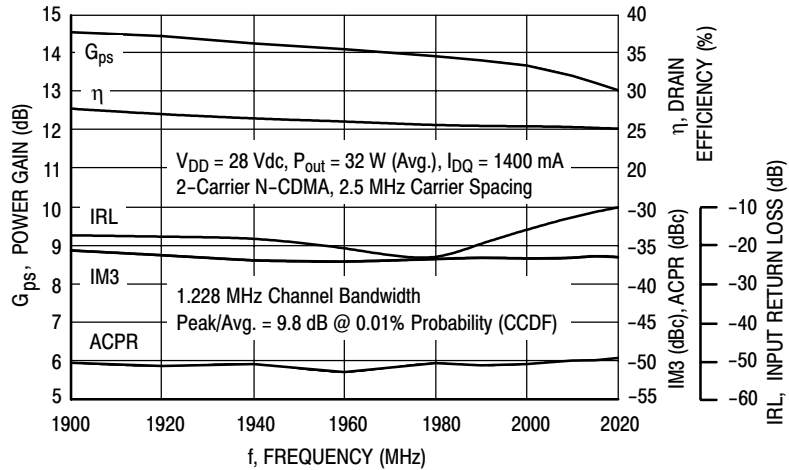

Figure 3. 2-Carrier N-CDMA Broadband Performance

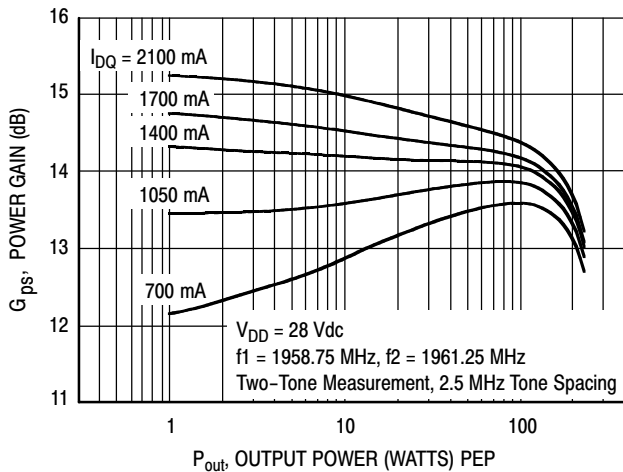

Figure 4. Two-Tone Power Gain versus Output Power

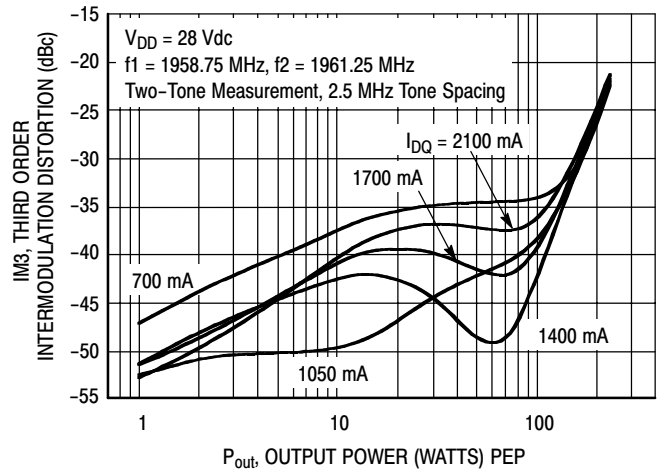

Figure 5. Third Order Intermodulation versus Output Power

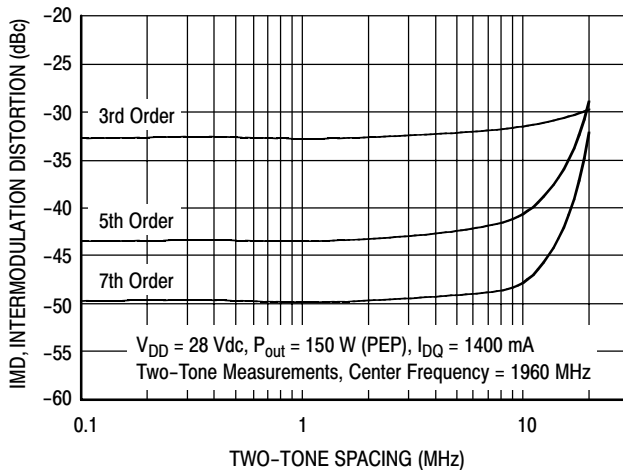

Figure 6. Intermodulation Distortion Products versus Tone Spacing

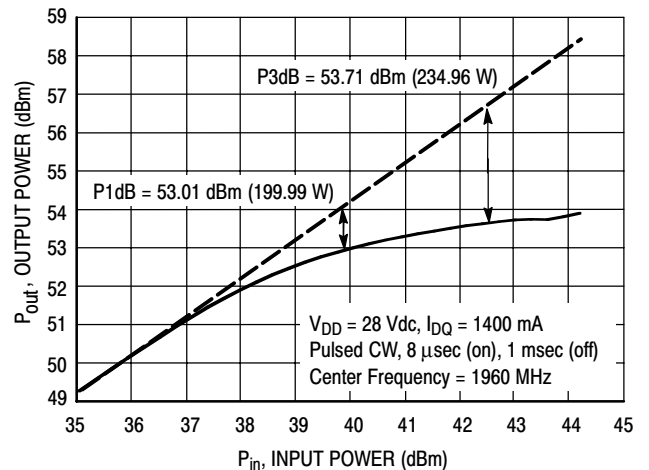

Figure 7. Pulse CW Output Power versus Input Power

Freescale Semiconductor, Inc. ARCHIVE INFORMATION

ARCHIVE INFORMATION

TYPICAL CHARACTERISTICS

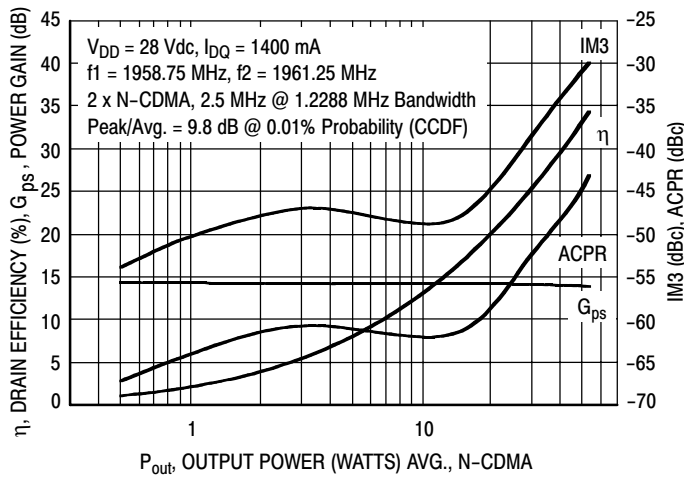

Figure 8. 2-Carrier N-CDMA ACPR, IM3, Power Gain, Drain Efficiency versus Output Power

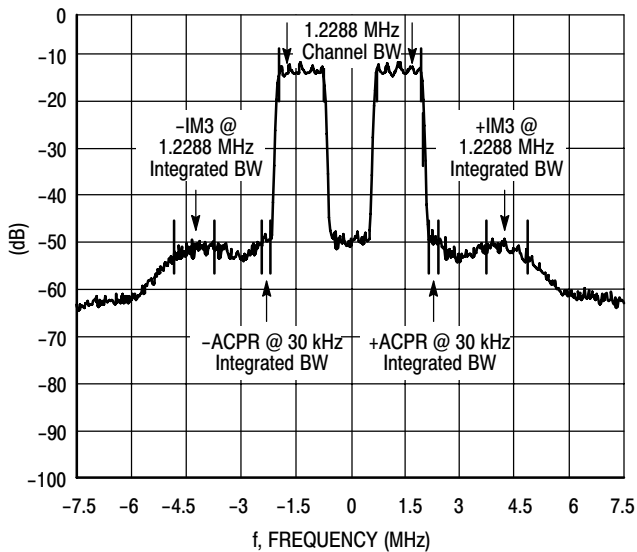
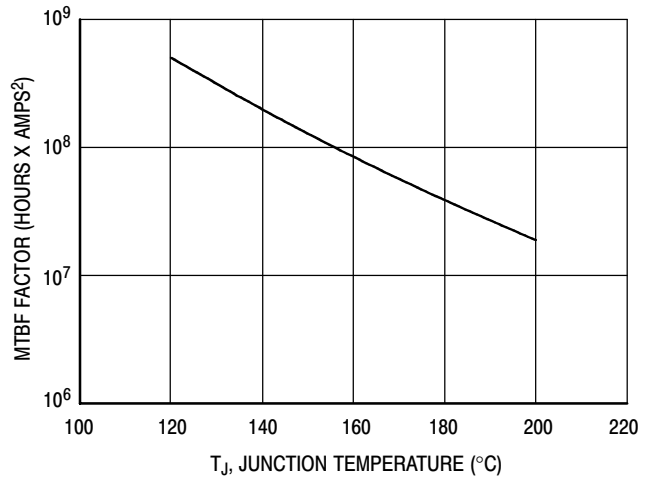
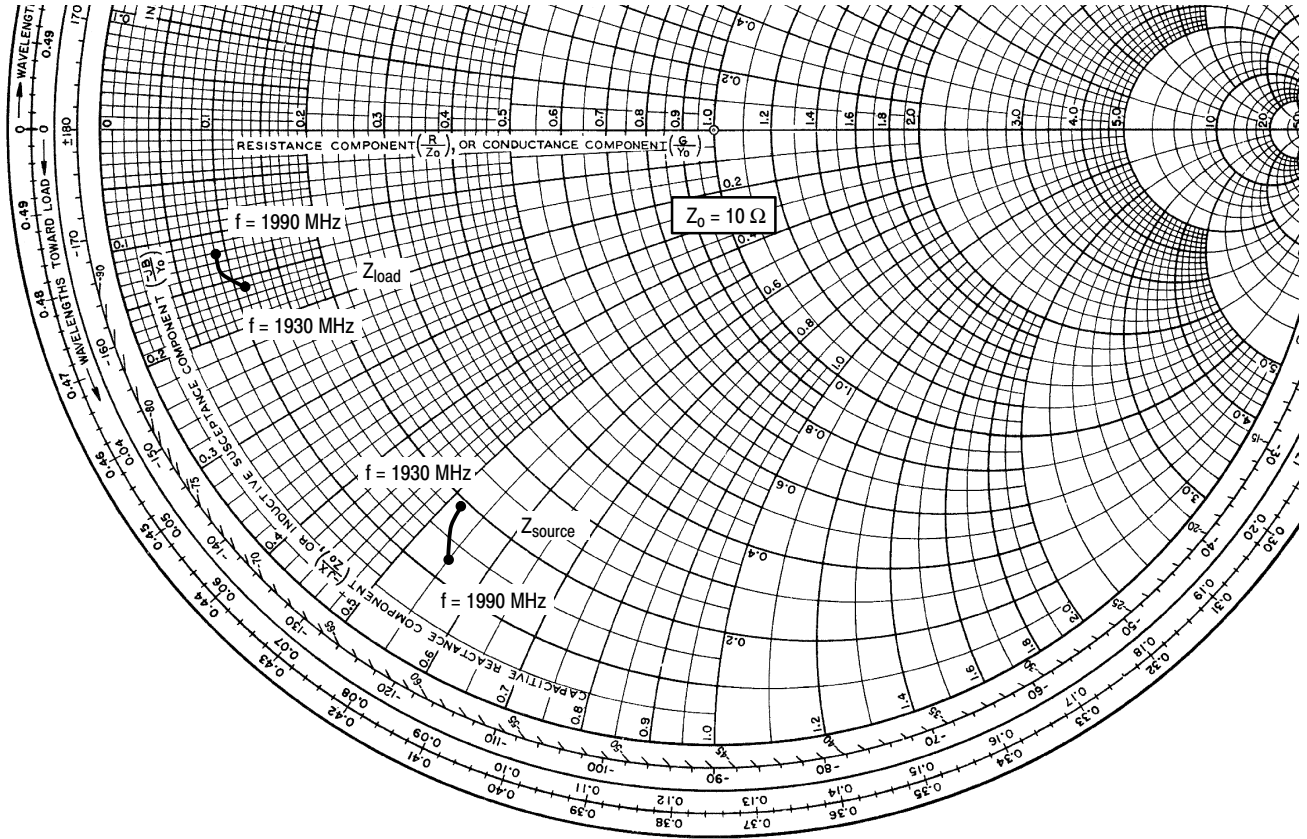

Figure 9. 2-Carrier N-CDMA Spectrum



This above graph displays calculated MTBF in hours x ampere² drain current. Life tests at elevated temperatures have correlated to better than $\pm 10\%$ of the theoretical prediction for metal failure. Divide MTBF factor by I_D^2 for MTBF in a particular application.

Figure 10. MTBF Factor versus Junction Temperature



$V_{DD} = 28\text{ V}$, $I_{DQ} = 1400\text{ mA}$, $P_{out} = 32\text{ W Avg.}$

f MHz	Z_{source} Ω	Z_{load} Ω
1930	$1.89 - j5.24$	$1.06 - j1.58$
1960	$1.64 - j5.29$	$0.88 - j1.37$
1990	$1.3 - j5.49$	$0.90 - j1.21$

Z_{source} = Test circuit impedance as measured from gate to ground.

Z_{load} = Test circuit impedance as measured from drain to ground.

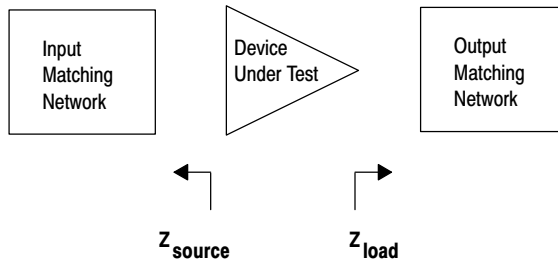

Figure 11. Series Equivalent Input and Output Impedance

NOTES

ARCHIVE INFORMATION

ARCHIVE INFORMATION

NOTES

ARCHIVE INFORMATION

ARCHIVE INFORMATION

Freescale Semiconductor, Inc.

PACKAGE DIMENSIONS

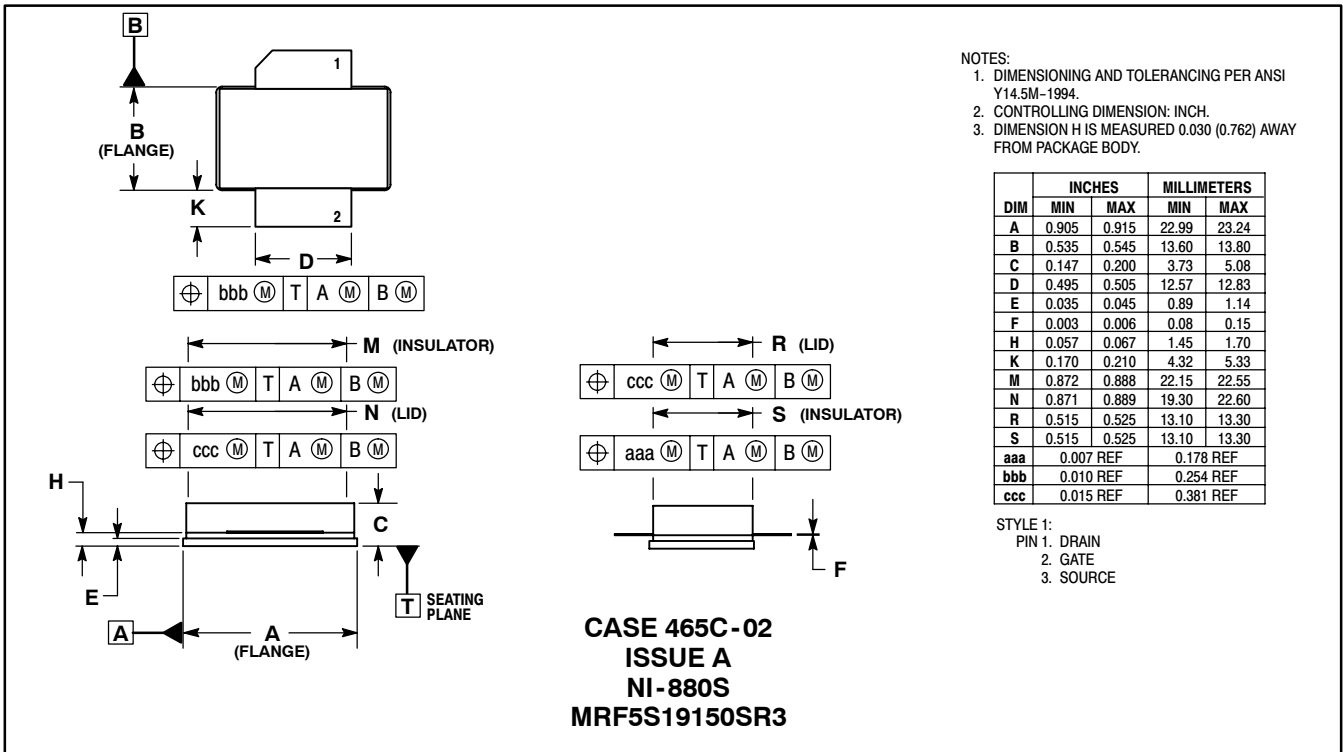
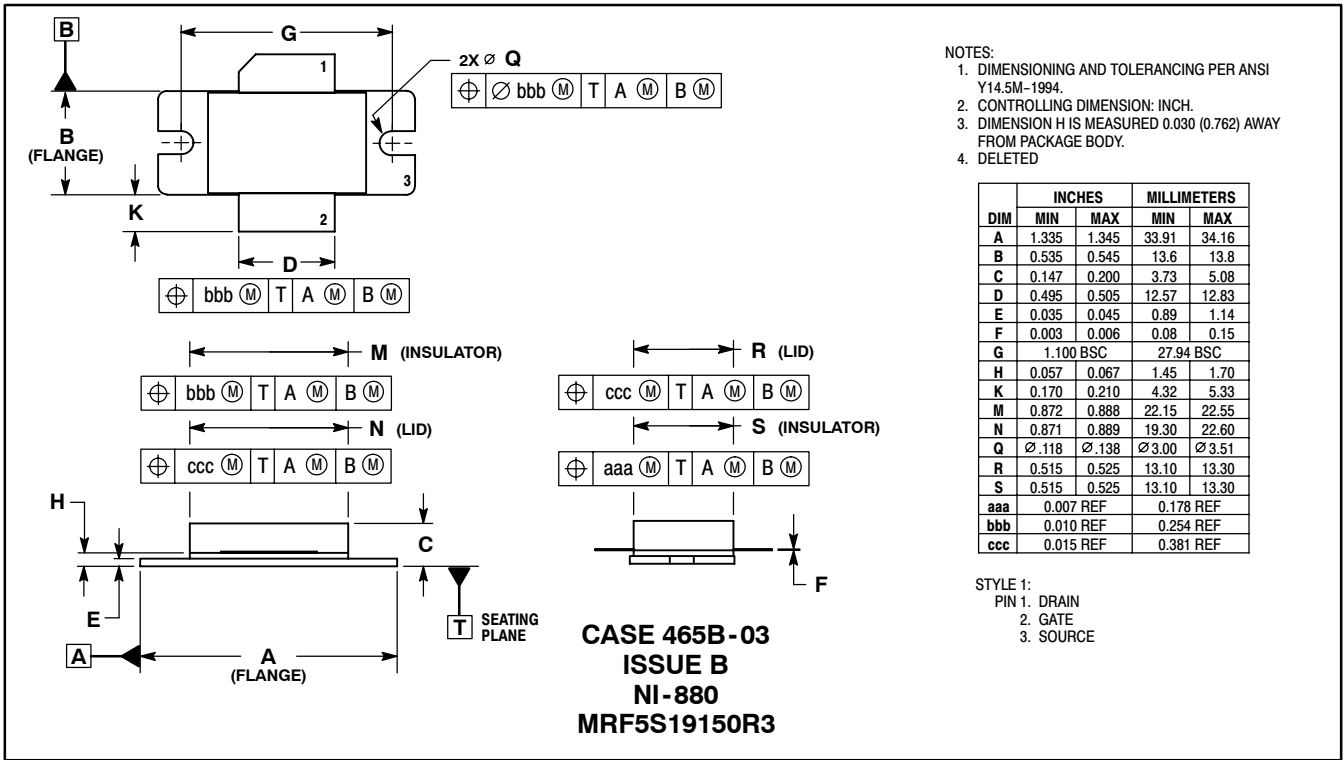

Freescale Semiconductor, Inc. ARCHIVE INFORMATION

ARCHIVE INFORMATION

Information in this document is provided solely to enable system and software implementers to use Motorola products. There are no express or implied copyright licenses granted hereunder to design or fabricate any integrated circuits or integrated circuits based on the information in this document.

Motorola reserves the right to make changes without further notice to any products herein. Motorola makes no warranty, representation or guarantee regarding the suitability of its products for any particular purpose, nor does Motorola assume any liability arising out of the application or use of any product or circuit, and specifically disclaims any and all liability, including without limitation consequential or incidental damages. "Typical" parameters that may be provided in Motorola data sheets and/or specifications can and do vary in different applications and actual performance may vary over time. All operating parameters, including "Typicals", must be validated for each customer application by customer's technical experts. Motorola does not convey any license under its patent rights nor the rights of others. Motorola products are not designed, intended, or authorized for use as components in systems intended for surgical implant into the body, or other applications intended to support or sustain life, or for any other application in which the failure of the Motorola product could create a situation where personal injury or death may occur. Should Buyer purchase or use Motorola products for any such unintended or unauthorized application, Buyer shall indemnify and hold Motorola and its officers, employees, subsidiaries, affiliates, and distributors harmless against all claims, costs, damages, and expenses, and reasonable attorney fees arising out of, directly or indirectly, any claim of personal injury or death associated with such unintended or unauthorized use, even if such claim alleges that Motorola was negligent regarding the design or manufacture of the part.

MOTOROLA and the Stylized M Logo are registered in the US Patent and Trademark Office. All other product or service names are the property of their respective owners. Motorola, Inc. is an Equal Opportunity/Affirmative Action Employer.

© Motorola Inc. 2004

HOW TO REACH US:

USA/EUROPE/LOCATIONS NOT LISTED:
Motorola Literature Distribution
P.O. Box 5405, Denver, Colorado 80217
1-800-521-6274 or 480-768-2130

JAPAN: Motorola Japan Ltd.; SPS, Technical Information Center,
3-20-1, Minami-Azabu, Minato-ku, Tokyo 106-8573, Japan
81-3-3440-3569

ASIA/PACIFIC: Motorola Semiconductors H.K. Ltd.; Silicon Harbour Centre,
2 Dai King Street, Tai Po Industrial Estate, Tai Po, N.T., Hong Kong
852-26668334

HOME PAGE: <http://motorola.com/semiconductors>



MOTOROLA

**For More Information On This Product,
Go to: www.freescale.com**

MRF5S19150/D