



# RF Power Field Effect Transistor

## N-Channel Enhancement-Mode Lateral MOSFET

Designed for broadband commercial and industrial applications with frequencies up to 1000 MHz. The high gain and broadband performance of this device make it ideal for large-signal, common-source amplifier applications in 26 volt base station equipment.

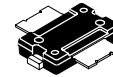
- Typical Single-Carrier N-CDMA Performance @ 880 MHz,  $V_{DD} = 26$  Volts,  $I_{DQ} = 600$  mA,  $P_{out} = 14$  Watts Avg., IS-95 CDMA (Pilot, Sync, Paging, Traffic Codes 8 Through 13)  
Power Gain — 17.8 dB  
Drain Efficiency — 30%  
ACPR @ 750 kHz Offset — -47 dBc in 30 kHz Bandwidth
- Capable of Handling 10:1 VSWR, @ 26 Vdc, 880 MHz, 70 Watts CW Output Power

### Features

- Characterized with Series Equivalent Large-Signal Impedance Parameters
- Integrated ESD Protection
- 200°C Capable Plastic Package
- N Suffix Indicates Lead-Free Terminations. RoHS Compliant.
- In Tape and Reel. R1 Suffix = 500 Units per 24 mm, 13 inch Reel.

**MRF5S9070NR1**

**880 MHz, 70 W, 26 V  
SINGLE N-CDMA  
LATERAL N-CHANNEL  
BROADBAND  
RF POWER MOSFET**



**CASE 1265-08, STYLE 1  
TO-270-2  
PLASTIC**

**Table 1. Maximum Ratings**

Rating	Symbol	Value	Unit
Drain-Source Voltage	$V_{DSS}$	- 0.5, +68	Vdc
Gate-Source Voltage	$V_{GS}$	- 0.5, +15	Vdc
Total Device Dissipation @ $T_C = 25^\circ\text{C}$ Derate above 25°C	$P_D$	219 1.25	W W/°C
Storage Temperature Range	$T_{stg}$	- 65 to +150	°C
Operating Junction Temperature	$T_J$	200	°C

**Table 2. Thermal Characteristics**

Characteristic	Symbol	Value (1,2)	Unit
Thermal Resistance, Junction to Case Case Temperature 80°C, 70 W CW Case Temperature 78°C, 14 W CW	$R_{\theta JC}$	0.80 0.93	°C/W

**Table 3. ESD Protection Characteristics**

Test Methodology	Class
Human Body Model (per JESD22-A114)	2 (Minimum)
Machine Model (per EIA/JESD22-A115)	A (Minimum)
Charge Device Model (per JESD22-C101)	IV (Minimum)

**Table 4. Moisture Sensitivity Level**

Test Methodology	Rating	Package Peak Temperature	Unit
Per JESD 22-A113, IPC/JEDEC J-STD-020	1	260	°C

1. MTTF calculator available at <http://www.freescale.com/rf>. Select Tools/Software/Application Software/Calculators to access the MTTF calculators by product.
2. Refer to AN1955, *Thermal Measurement Methodology of RF Power Amplifiers*. Go to <http://www.freescale.com/rf>. Select Documentation/Application Notes - AN1955.

**Table 5. Electrical Characteristics** ( $T_C = 25^\circ\text{C}$  unless otherwise noted)

Characteristic	Symbol	Min	Typ	Max	Unit
<b>Off Characteristics</b>					
Zero Gate Voltage Drain Leakage Current ( $V_{DS} = 68\text{ Vdc}$ , $V_{GS} = 0\text{ Vdc}$ )	$I_{DSS}$	—	—	10	$\mu\text{Adc}$
Zero Gate Voltage Drain Leakage Current ( $V_{DS} = 26\text{ Vdc}$ , $V_{GS} = 0\text{ Vdc}$ )	$I_{DSS}$	—	—	1	$\mu\text{Adc}$
Gate-Source Leakage Current ( $V_{GS} = 5\text{ Vdc}$ , $V_{DS} = 0\text{ Vdc}$ )	$I_{GSS}$	—	—	1	$\mu\text{Adc}$

**On Characteristics**

Gate Threshold Voltage ( $V_{DS} = 10\text{ Vdc}$ , $I_D = 200\ \mu\text{A}$ )	$V_{GS(th)}$	2	2.7	4	Vdc
Gate Quiescent Voltage ( $V_{DS} = 26\text{ Vdc}$ , $I_D = 600\text{ mAdc}$ )	$V_{GS(Q)}$	—	3.7	—	Vdc
Drain-Source On-Voltage ( $V_{GS} = 10\text{ Vdc}$ , $I_D = 1.0\text{ Adc}$ )	$V_{DS(on)}$	—	0.18	0.22	Vdc
Forward Transconductance ( $V_{DS} = 10\text{ Vdc}$ , $I_D = 4\text{ Adc}$ )	$g_{fs}$	—	4.7	—	S

**Dynamic Characteristic**

Input Capacitance ( $V_{DS} = 26\text{ Vdc} \pm 30\text{ mV(rms)ac}$ @ 1 MHz, $V_{GS} = 0\text{ Vdc}$ )	$C_{iss}$	—	126	—	pF
Output Capacitance ( $V_{DS} = 26\text{ Vdc} \pm 30\text{ mV(rms)ac}$ @ 1 MHz, $V_{GS} = 0\text{ Vdc}$ )	$C_{oss}$	—	34	—	pF
Reverse Transfer Capacitance ( $V_{DS} = 26\text{ Vdc} \pm 30\text{ mV(rms)ac}$ @ 1 MHz, $V_{GS} = 0\text{ Vdc}$ )	$C_{rss}$	—	1.37	—	pF

**Functional Tests** (In Freescale Test Fixture, 50 ohm system)  $V_{DD} = 26\text{ Vdc}$ ,  $I_{DQ} = 600\text{ mA}$ ,  $P_{out} = 14\text{ W Avg.}$ ,  $f = 880\text{ MHz}$ , Single-Carrier N-CDMA, 1.2288 MHz Channel Bandwidth Carrier. ACPR measured in 30 kHz Channel Bandwidth @  $\pm 750\text{ kHz}$  Offset. PAR = 9.8 dB @ 0.01% Probability on CCDF

Power Gain	$G_{ps}$	17	17.8	—	dB
Drain Efficiency	$\eta_D$	29	30	—	%
Adjacent Channel Power Ratio	ACPR	—	-47	-45	dBc
Input Return Loss	IRL	—	-19	-9	dB

**Typical GSM CW Performances** (In Freescale GSM Test Fixture Optimized for 921-960 MHz, 50 ohm system)  $V_{DD} = 26\text{ Vdc}$ ,  $I_{DQ} = 400\text{ mA}$ ,  $P_{out} = 60\text{ W}$ ,  $f = 921-960\text{ MHz}$

Power Gain	$G_{ps}$	—	16.4	—	dB
Drain Efficiency	$\eta_D$	—	62	—	%
Input Return Loss	IRL	—	-12	—	dB
$P_{out}$ @ 1 dB Compression Point ( $f = 940\text{ MHz}$ )	P1dB	—	68	—	W

**Typical GSM EDGE Performances** (In Freescale GSM EDGE Test Fixture Optimized for 921-960 MHz, 50 ohm system)

$V_{DD} = 26\text{ Vdc}$ ,  $I_{DQ} = 400\text{ mA}$ ,  $P_{out} = 25\text{ W Avg.}$ ,  $f = 921-960\text{ MHz}$ , GSM EDGE Signal

Power Gain	$G_{ps}$	—	17	—	dB
Drain Efficiency	$\eta_D$	—	44	—	%
Error Vector Magnitude	EVM	—	1.5	—	%
Spectral Regrowth at 400 kHz Offset	SR1	—	-62	—	dBc
Spectral Regrowth at 600 kHz Offset	SR2	—	-78	—	dBc

(continued)

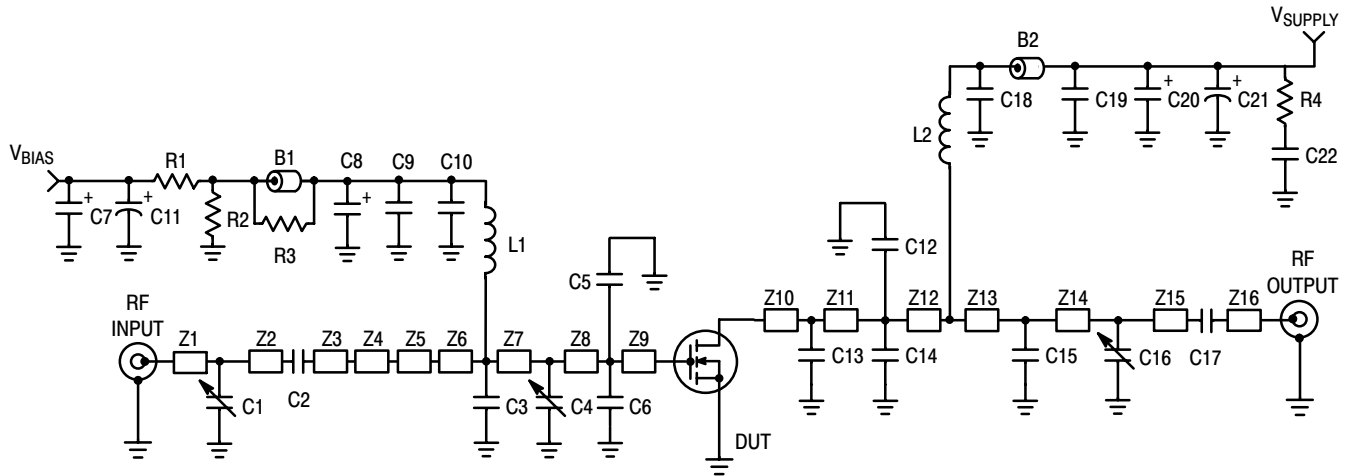
**Table 5. Electrical Characteristics** ( $T_C = 25^\circ\text{C}$  unless otherwise noted) (continued)

Characteristic	Symbol	Min	Typ	Max	Unit
<b>Typical GSM CW Performances</b> (In Freescale GSM Test Fixture Optimized for 865-895 MHz, 50 ohm system) $V_{DD} = 26\text{ Vdc}$ , $I_{DQ} = 400\text{ mA}$ , $P_{out} = 60\text{ W}$ , $f = 865\text{ - }895\text{ MHz}$					
Power Gain	$G_{ps}$	—	16.4	—	dB
Drain Efficiency	$\eta_D$	—	59	—	%
Input Return Loss	IRL	—	-15	—	dB
$P_{out}$ @ 1 dB Compression Point ( $f = 880\text{ MHz}$ )	P1dB	—	71	—	W

**Typical GSM EDGE Performances** (In Freescale GSM EDGE Test Fixture Optimized for 865-895 MHz, 50 ohm system)  $V_{DD} = 26\text{ Vdc}$ ,  $I_{DQ} = 400\text{ mA}$ ,  $P_{out} = 25\text{ W Avg.}$ ,  $f = 865\text{ - }895\text{ MHz}$ , GSM EDGE Signal

Power Gain	$G_{ps}$	—	17	—	dB
Drain Efficiency	$\eta_D$	—	41	—	%
Error Vector Magnitude	EVM	—	1.35	—	%
Spectral Regrowth at 400 kHz Offset	SR1	—	-66	—	dBc
Spectral Regrowth at 600 kHz Offset	SR2	—	-81	—	dBc

www.DataSheet4U.com



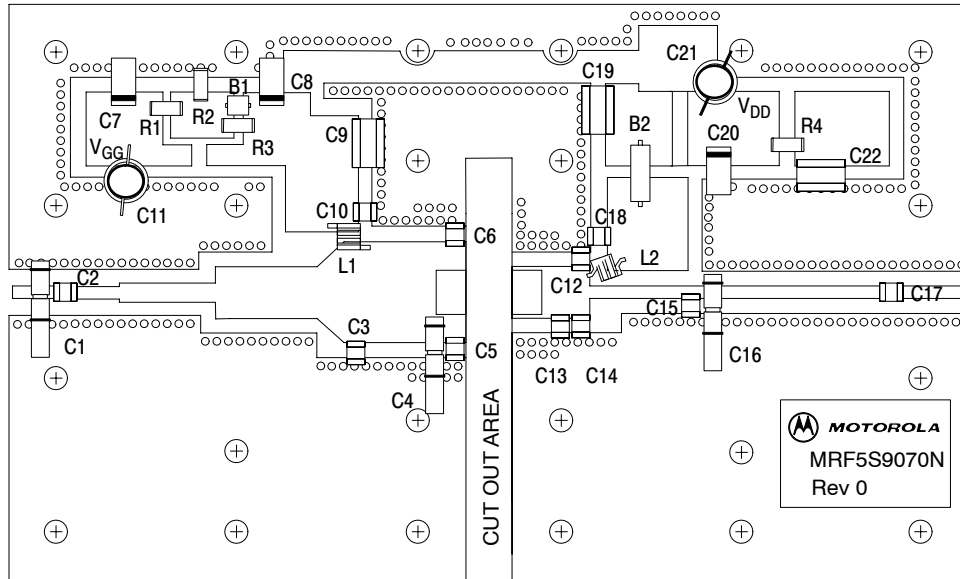
www.DataSheet4U.com

Z1	0.140" x 0.060" Microstrip	Z10	0.245" x 0.270" Microstrip
Z2	0.141" x 0.060" Microstrip	Z11	0.110" x 0.270" Microstrip
Z3	0.280" x 0.060" Microstrip	Z12	0.055" x 0.270" Microstrip
Z4	0.500" x 0.100" Microstrip	Z13	0.512" x 0.060" Microstrip
Z5	0.530" x 0.270" Microstrip	Z14	0.106" x 0.060" Microstrip
Z6	0.155" x 0.270" x 0.530" Taper	Z15	0.930" x 0.060" Microstrip
Z7	0.376" x 0.530" Microstrip	Z16	0.365" x 0.060" Microstrip
Z8	0.116" x 0.530" Microstrip	PCB	Taconic RF-35, 0.030", $\epsilon_r = 3.5$
Z9	0.055" x 0.530" Microstrip		

Figure 1. MRF5S9070NR1 Test Circuit Schematic

Table 6. MRF5S9070NR1 Test Circuit Component Designations and Values

Part	Description	Part Number	Manufacturer
B1	Small Ferrite Bead, Surface Mount	2743019447	Fair-Rite
B2	Large Ferrite Bead, Surface Mount	2743021447	Fair-Rite
C1	0.6 - 6.0 pF Variable Capacitor, Gigatrim	272715L	Johanson
C2	16 pF Chip Capacitor	100B160JP500X	ATC
C3	7.5 pF Chip Capacitor	100B7R5JP500X	ATC
C4, C16	0.8 - 8.0 pF Variable Capacitor, Gigatrim	272915L	Johanson
C5, C6	15 pF Chip Capacitors	100B150JP500X	ATC
C7, C8, C20	10 $\mu$ F, 35 V Tantalum Capacitors	T491D106K035AS	Kemet
C9, C19, C22	0.58 $\mu$ F Chip Capacitors	700A561MP150X	ATC
C10, C18	18 pF Chip Capacitors	100B180JP500X	ATC
C11	100 $\mu$ F, 50 V Electrolytic Capacitor	515D107M050BB6A	Vishay-Dale
C12, C14	13 pF Chip Capacitors	100B130JP500X	ATC
C13	0.7 pF Chip Capacitor	100B0R7BP500X	ATC
C15	3.9 pF Chip Capacitor	100B3R9JP500X	ATC
C17	22 pF Chip Capacitor	100B180JP500X	ATC
C21	470 $\mu$ F, 63 V Electrolytic Capacitor	SME63VB471M12X25LL	United Chemi-Con
L1, L2	12.5 nH Surface Mount Inductors	A04T-5	Coilcraft
R1	1 k $\Omega$ Chip Resistor		
R2	560 k $\Omega$ Chip Resistor		
R3	12 $\Omega$ Chip Resistor		
R4	27 $\Omega$ Chip Resistor		

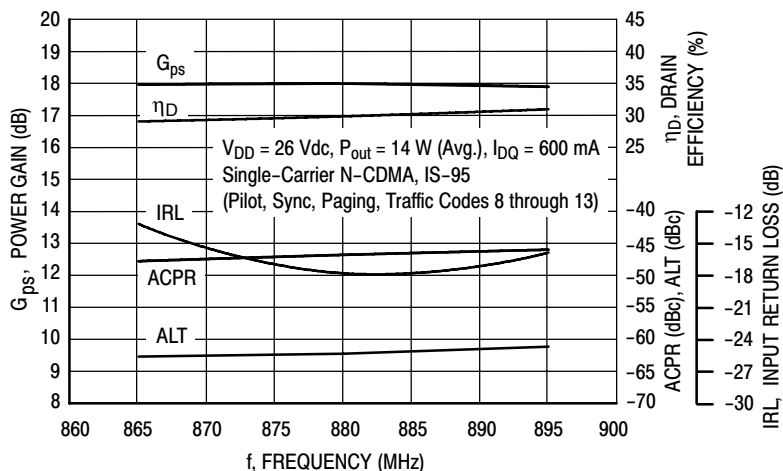


www.DataSheet4U.com

Freescale has begun the transition of marking Printed Circuit Boards (PCBs) with the Freescale Semiconductor signature/logo. PCBs may have either Motorola or Freescale markings during the transition period. These changes will have no impact on form, fit or function of the current product.

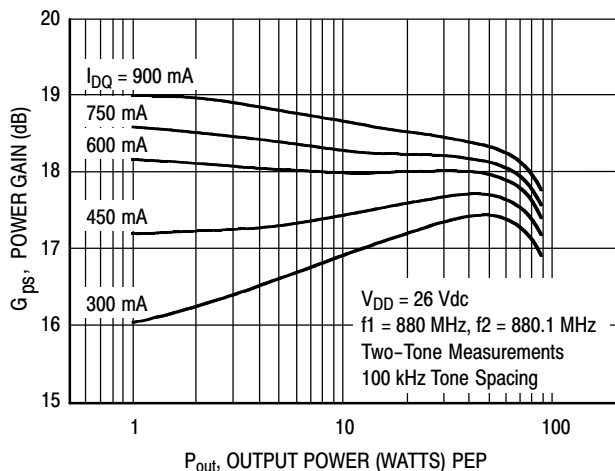
**Figure 2. MRF5S9070NR1 Test Circuit Component Layout**

## TYPICAL CHARACTERISTICS

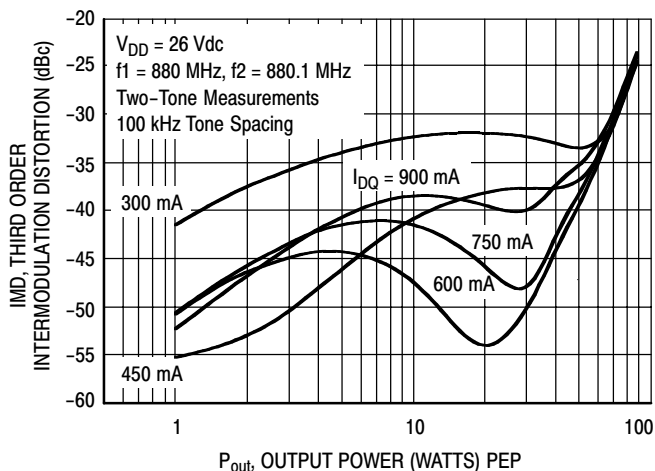


**Figure 3. Class AB Broadband Performance**

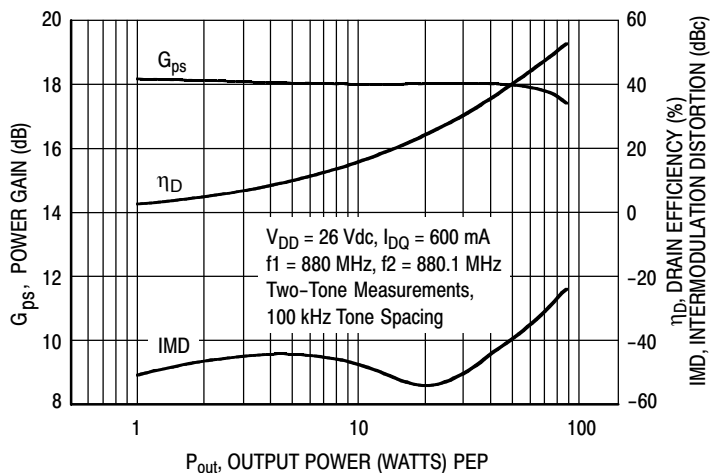
www.DataSheet4U.com



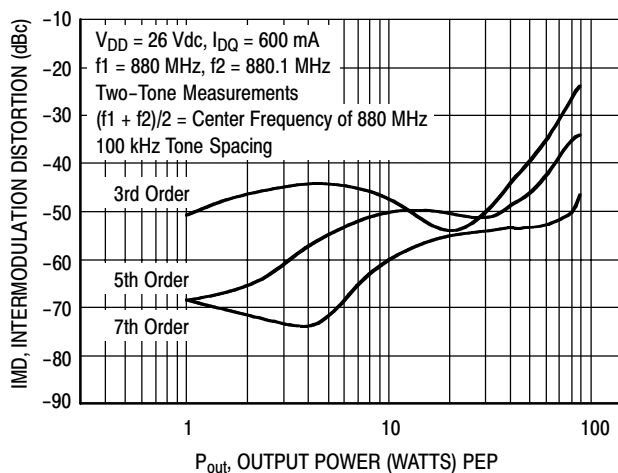
**Figure 4. Two-Tone Power Gain versus Output Power**



**Figure 5. Third Order Intermodulation Distortion versus Output Power**

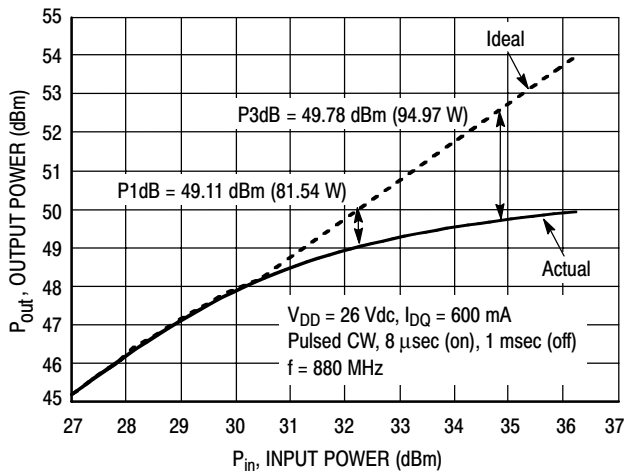


**Figure 6. Power Gain, Drain Efficiency and IMD versus Output Power**

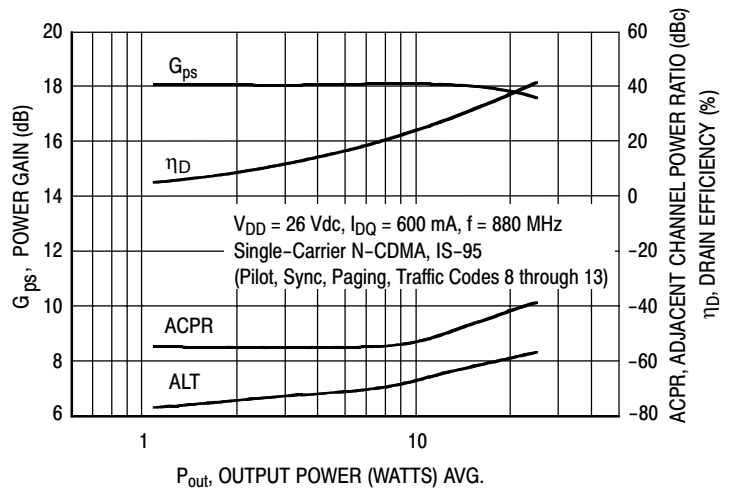


**Figure 7. Intermodulation Distortion Products versus Output Power**

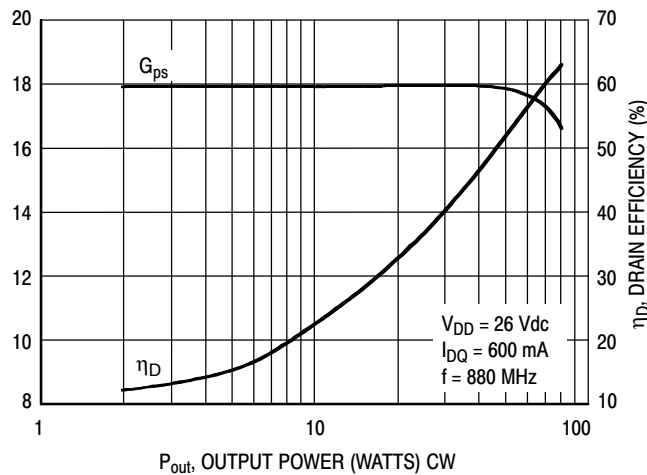
## TYPICAL CHARACTERISTICS



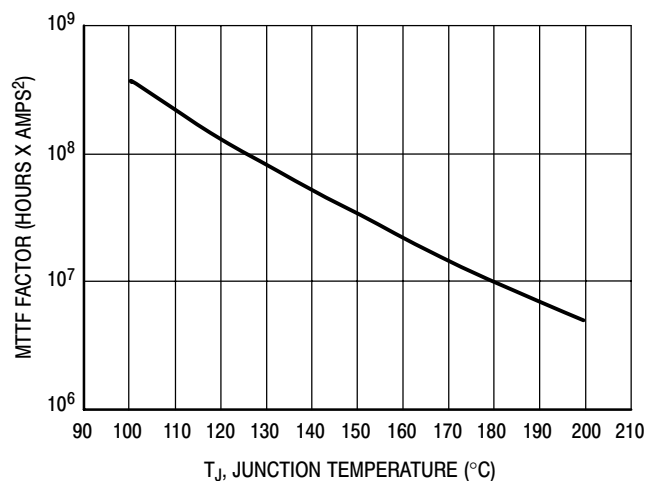
**Figure 8. Pulse CW Output Power versus Input Power**



**Figure 9. N-CDMA ACPR, Power Gain and Drain Efficiency versus Output Power**



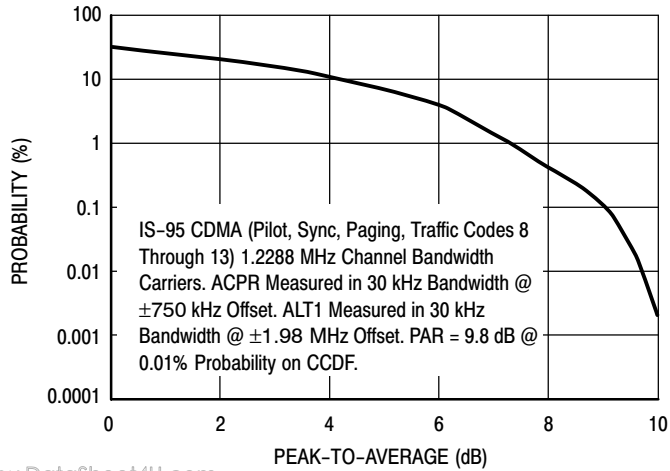
**Figure 10. Power Gain and Drain Efficiency versus CW Output Power**



This above graph displays calculated MTTF in hours  $\times$  ampere<sup>2</sup> drain current. Life tests at elevated temperatures have correlated to better than  $\pm 10\%$  of the theoretical prediction for metal failure. Divide MTTF factor by  $I_D^2$  for MTTF in a particular application.

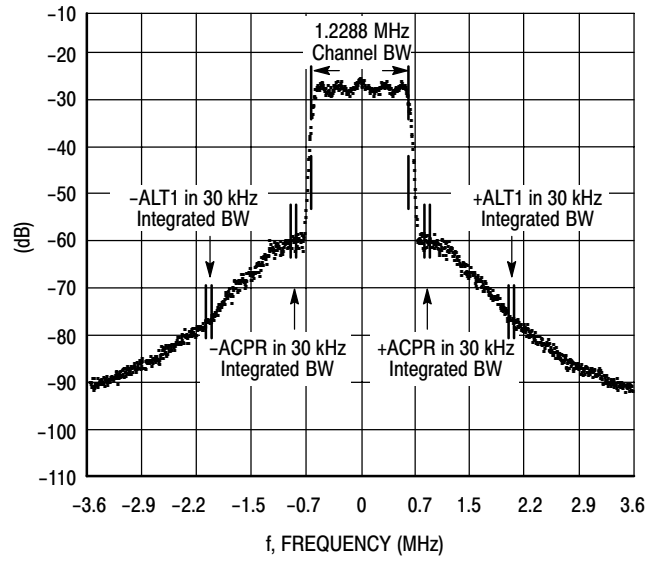
**Figure 11. MTTF Factor versus Junction Temperature**

## N-CDMA TEST SIGNAL



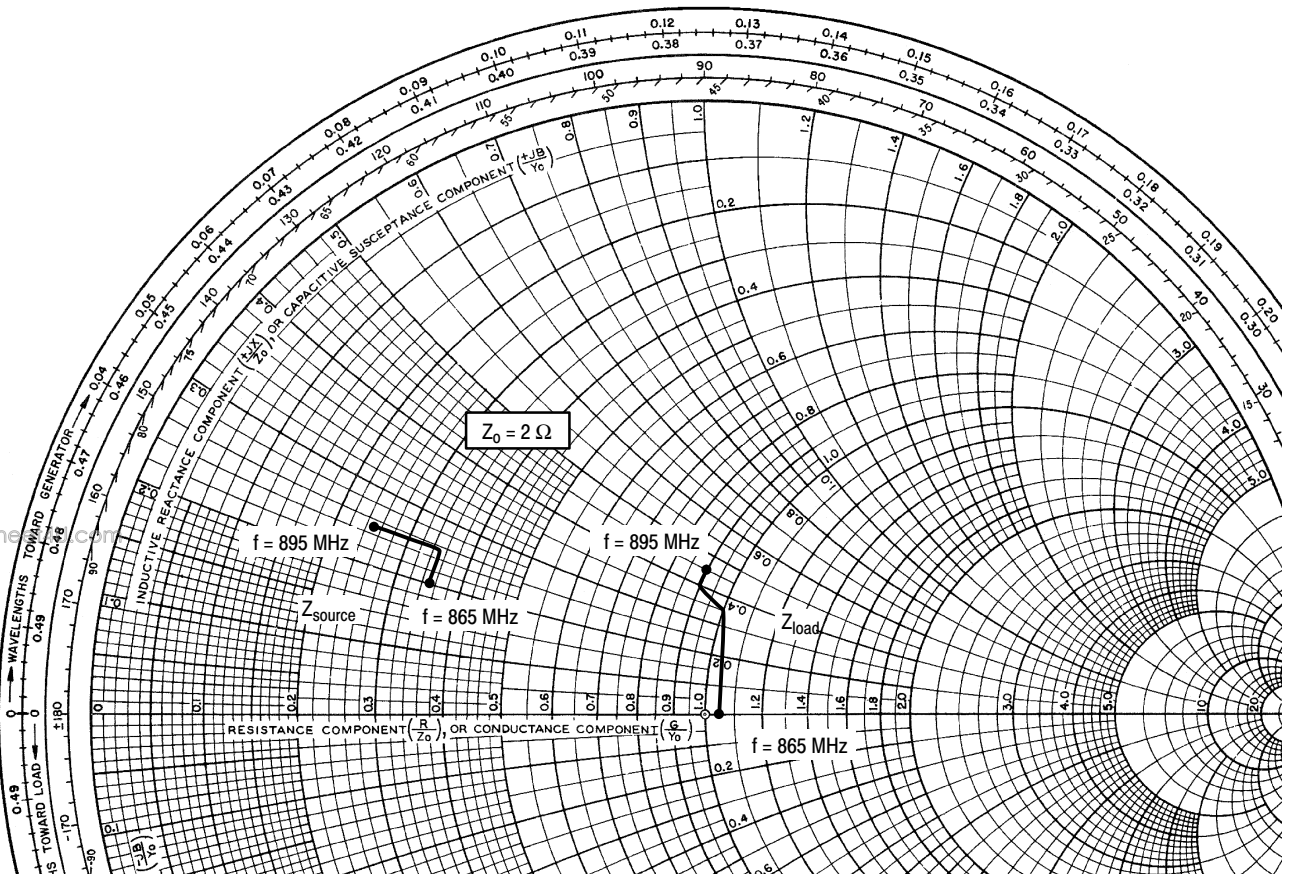
www.DataSheet4U.com

**Figure 12. Single-Carrier CCDF N-CDMA**



**Figure 13. Single-Carrier N-CDMA Spectrum**





$V_{DD} = 26 \text{ Vdc}$ ,  $I_{DQ} = 600 \text{ mA}$ ,  $P_{out} = 14 \text{ W Avg.}$

f MHz	$Z_{source}$ $\Omega$	$Z_{load}$ $\Omega$
865	$0.7 + j0.4$	$2.1 + j0.6$
875	$0.7 + j0.5$	$2.0 + j0.7$
885	$0.6 + j0.5$	$1.8 + j0.8$
895	$0.5 + j0.5$	$1.8 + j0.9$

$Z_{source}$  = Test circuit impedance as measured from gate to ground.

$Z_{load}$  = Test circuit impedance as measured from drain to ground.

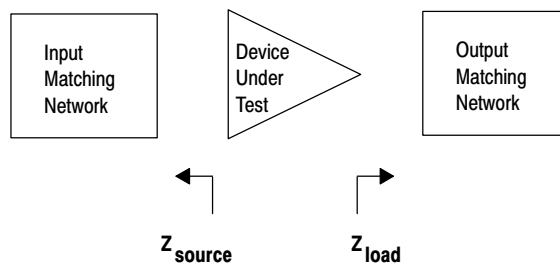


Figure 14. Series Equivalent Source and Load Impedance

# NOTES

[www.DataSheet4U.com](http://www.DataSheet4U.com)

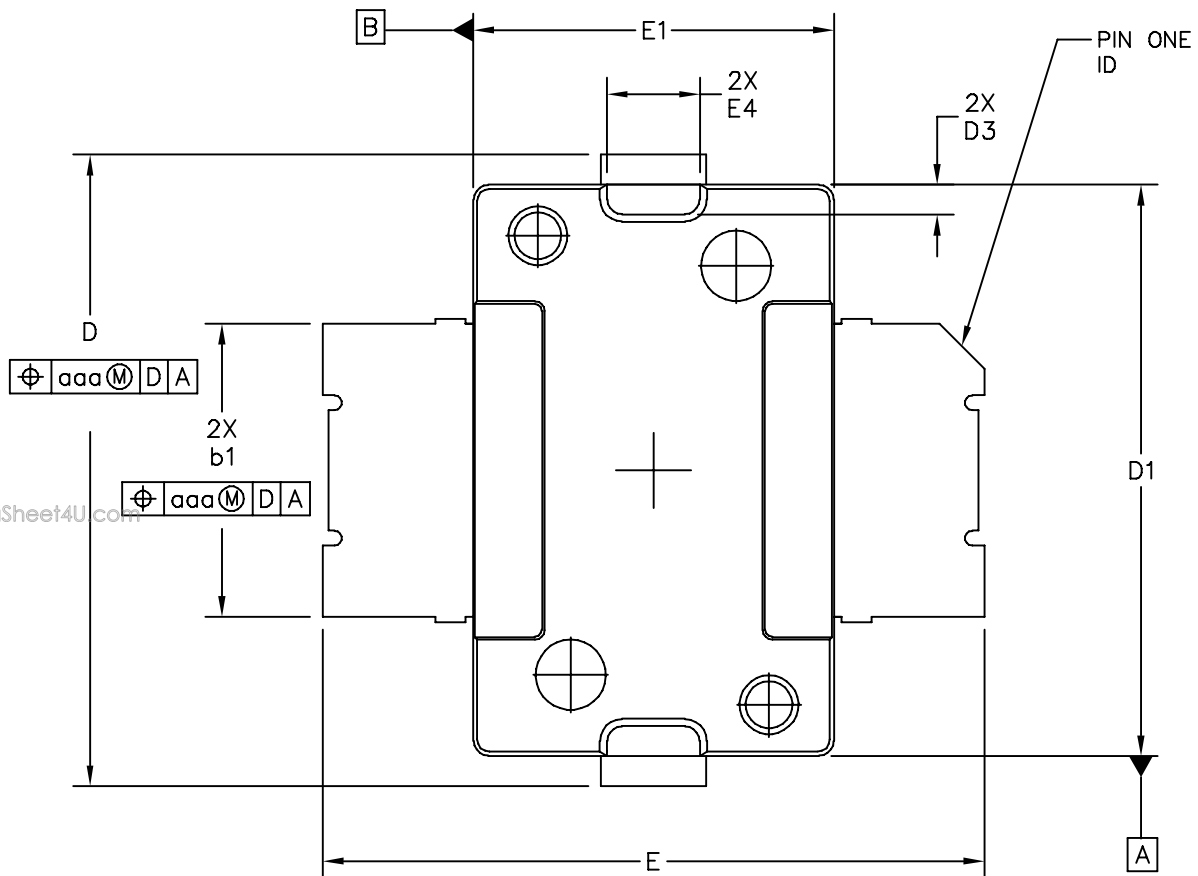
# NOTES

[www.DataSheet4U.com](http://www.DataSheet4U.com)

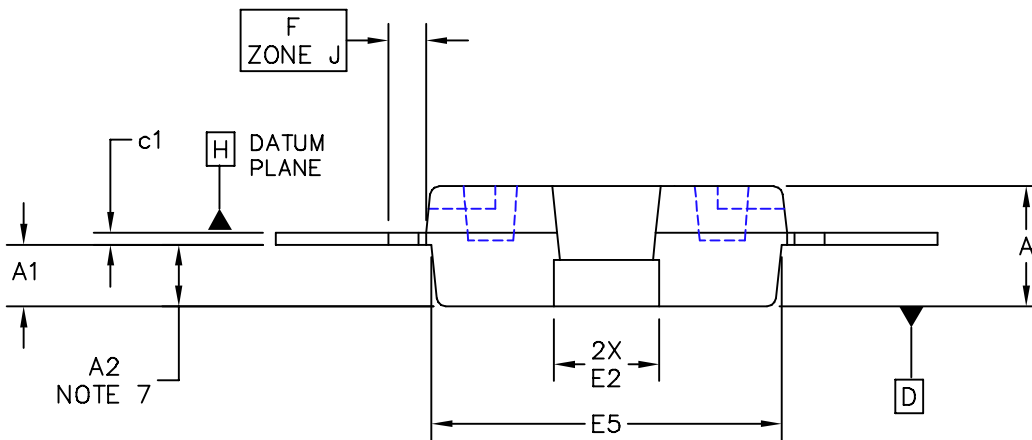
# NOTES

[www.DataSheet4U.com](http://www.DataSheet4U.com)

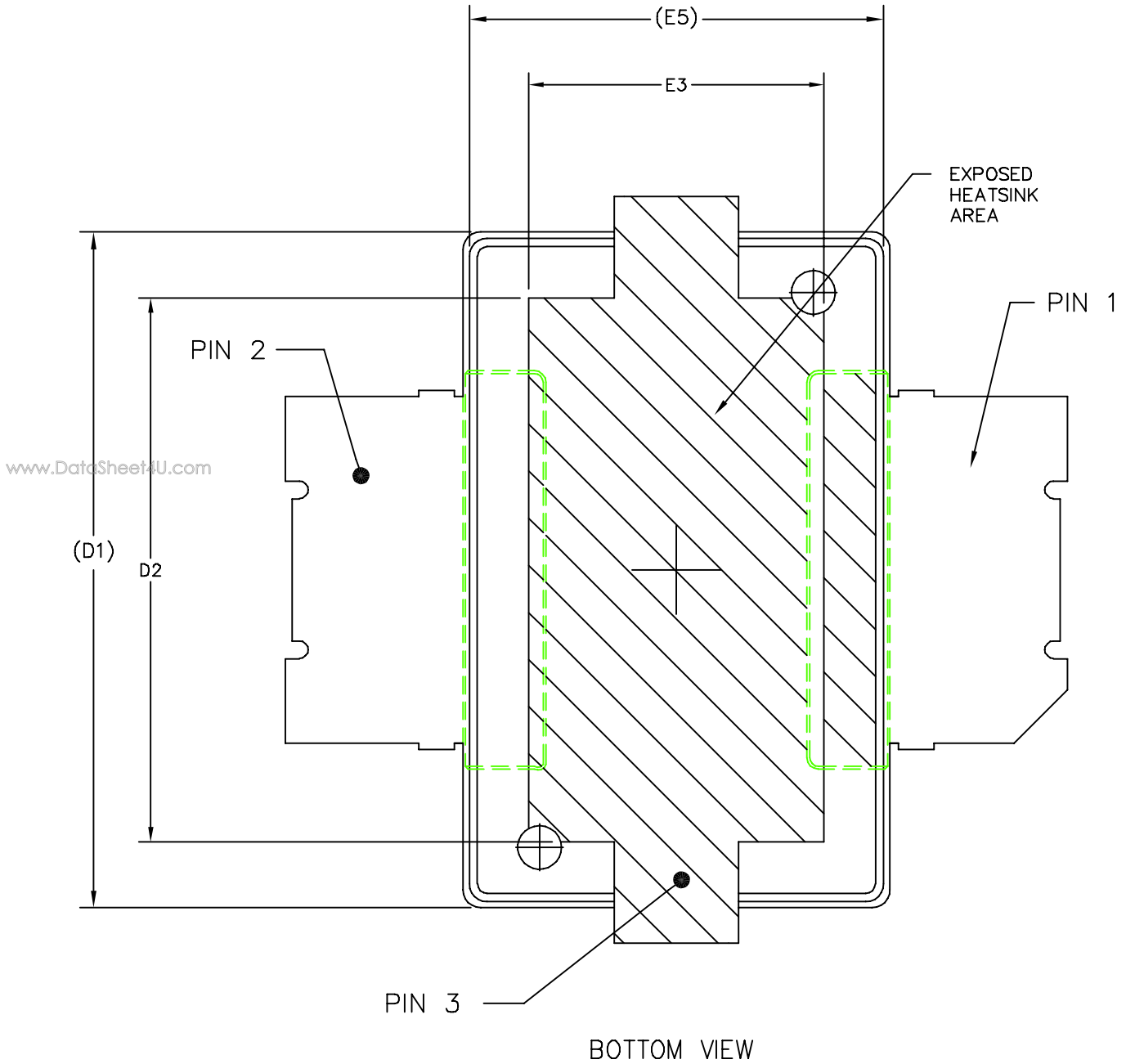
**PACKAGE DIMENSIONS**



www.DataSheet4U.com



© FREESCALE SEMICONDUCTOR, INC. ALL RIGHTS RESERVED.	<b>MECHANICAL OUTLINE</b>	PRINT VERSION NOT TO SCALE	
TITLE: <b>TO-270 SURFACE MOUNT</b>	DOCUMENT NO: 98ASH98117A	REV: J	
	CASE NUMBER: 1265-08	01 APR 2005	
	STANDARD: NON-JEDEC		



© FREESCALE SEMICONDUCTOR, INC. ALL RIGHTS RESERVED.	<b>MECHANICAL OUTLINE</b>	PRINT VERSION NOT TO SCALE	
TITLE: TO-270 SURFACE MOUNT	DOCUMENT NO: 98ASH98117A	REV: J	
	CASE NUMBER: 1265-08	01 APR 2005	
	STANDARD: NON-JEDEC		

NOTES:

1. CONTROLLING DIMENSION: INCH
2. INTERPRET DIMENSIONS AND TOLERANCES PER ASME Y14.5M-1994.
3. DATUM PLANE -H- IS LOCATED AT TOP OF LEAD AND IS COINCIDENT WITH THE LEAD WHERE THE LEAD EXITS THE PLASTIC BODY AT THE TOP OF THE PARTING LINE.
4. DIMENSIONS "D1" AND "E1" DO NOT INCLUDE MOLD PROTRUSION. ALLOWABLE PROTRUSION IS .006 PER SIDE. DIMENSIONS "D1 AND "E1" DO INCLUDE MOLD MISMATCH AND ARE DETERMINED AT DATUM PLANE -H-.
5. DIMENSION "b1" DOES NOT INCLUDE DAMBAR PROTRUSION. ALLOWABLE DAMBAR PROTRUSION SHALL BE .005 TOTAL IN EXCESS OF THE "b1" DIMENSION AT MAXIMUM MATERIAL CONDITION.
6. DATUMS -A- AND -B- TO BE DETERMINED AT DATUM PLANE -H-.
7. DIMENSION "A2" APPLIES WITHIN ZONE "J" ONLY.
8. DIMENSIONS "D" AND "E2" DO NOT INCLUDE MOLD PROTRUSION. OVERALL LENGTH INCLUDING MOLD PROTRUSION SHOULD NOT EXCEED 0.430 INCH FOR DIMENSION "D" AND 0.080 INCH FOR DIMENSION "E2". DIMENSIONS "D" AND "E2" DO INCLUDE MOLD MISMATCH AND ARE DETERMINED AT DATUM PLANE -D-.

STYLE 1:

- PIN 1 - DRAIN
- PIN 2 - GATE
- PIN 3 - SOURCE

DIM	INCH		MILLIMETER		DIM	INCH		MILLIMETER	
	MIN	MAX	MIN	MAX		MIN	MAX	MIN	MAX
A	.078	.082	1.98	2.08	F	.025 BSC		0.64 BSC	
A1	.039	.043	0.99	1.09	b1	.193	.199	4.90	5.06
A2	.040	.042	1.02	1.07	c1	.007	.011	0.18	0.28
D	.416	.424	10.57	10.77	aaa	.004		0.10	
D1	.378	.382	9.60	9.70					
D2	.290	.320	7.37	8.13					
D3	.016	.024	0.41	0.61					
E	.436	.444	11.07	11.28					
E1	.238	.242	6.04	6.15					
E2	.066	.074	1.68	1.88					
E3	.150	.180	3.81	4.57					
E4	.058	.066	1.47	1.68					
E5	.231	.235	5.87	5.97					

© FREESCALE SEMICONDUCTOR, INC. ALL RIGHTS RESERVED.		<b>MECHANICAL OUTLINE</b>		PRINT VERSION NOT TO SCALE	
TITLE:  TO-270 SURFACE MOUNT		DOCUMENT NO: 98ASH98117A		REV: J	
		CASE NUMBER: 1265-08		01 APR 2005	
		STANDARD: NON-JEDEC			

## How to Reach Us:

### Home Page:

[www.freescale.com](http://www.freescale.com)

### E-mail:

[support@freescale.com](mailto:support@freescale.com)

### USA/Europe or Locations Not Listed:

Freescale Semiconductor  
Technical Information Center, CH370  
1300 N. Alma School Road  
Chandler, Arizona 85224  
+1-800-521-6274 or +1-480-768-2130  
[support@freescale.com](mailto:support@freescale.com)

### Europe, Middle East, and Africa:

Freescale Halbleiter Deutschland GmbH  
Technical Information Center  
Schatzbogen 7  
81829 Muenchen, Germany  
+44 1296 380 456 (English)  
+46 8 52200080 (English)  
+49 89 92103 559 (German)  
+33 1 69 35 48 48 (French)  
[support@freescale.com](mailto:support@freescale.com)

### Japan:

Freescale Semiconductor Japan Ltd.  
Headquarters  
ARCO Tower 15F  
1-8-1, Shimo-Meguro, Meguro-ku,  
Tokyo 153-0064  
Japan  
0120 191014 or +81 3 5437 9125  
[support.japan@freescale.com](mailto:support.japan@freescale.com)

### Asia/Pacific:

Freescale Semiconductor Hong Kong Ltd.  
Technical Information Center  
2 Dai King Street  
Tai Po Industrial Estate  
Tai Po, N.T., Hong Kong  
+800 2666 8080  
[support.asia@freescale.com](mailto:support.asia@freescale.com)

### For Literature Requests Only:

Freescale Semiconductor Literature Distribution Center  
P.O. Box 5405  
Denver, Colorado 80217  
1-800-441-2447 or 303-675-2140  
Fax: 303-675-2150  
[LDCForFreescaleSemiconductor@hibbertgroup.com](mailto:LDCForFreescaleSemiconductor@hibbertgroup.com)

Information in this document is provided solely to enable system and software implementers to use Freescale Semiconductor products. There are no express or implied copyright licenses granted hereunder to design or fabricate any integrated circuits or integrated circuits based on the information in this document.

Freescale Semiconductor reserves the right to make changes without further notice to any products herein. Freescale Semiconductor makes no warranty, representation or guarantee regarding the suitability of its products for any particular purpose, nor does Freescale Semiconductor assume any liability arising out of the application or use of any product or circuit, and specifically disclaims any and all liability, including without limitation consequential or incidental damages. "Typical" parameters that may be provided in Freescale Semiconductor data sheets and/or specifications can and do vary in different applications and actual performance may vary over time. All operating parameters, including "Typicals", must be validated for each customer application by customer's technical experts. Freescale Semiconductor does not convey any license under its patent rights nor the rights of others. Freescale Semiconductor products are not designed, intended, or authorized for use as components in systems intended for surgical implant into the body, or other applications intended to support or sustain life, or for any other application in which the failure of the Freescale Semiconductor product could create a situation where personal injury or death may occur. Should Buyer purchase or use Freescale Semiconductor products for any such unintended or unauthorized application, Buyer shall indemnify and hold Freescale Semiconductor and its officers, employees, subsidiaries, affiliates, and distributors harmless against all claims, costs, damages, and expenses, and reasonable attorney fees arising out of, directly or indirectly, any claim of personal injury or death associated with such unintended or unauthorized use, even if such claim alleges that Freescale Semiconductor was negligent regarding the design or manufacture of the part.

Freescale™ and the Freescale logo are trademarks of Freescale Semiconductor, Inc. All other product or service names are the property of their respective owners.  
© Freescale Semiconductor, Inc. 2006. All rights reserved.

RoHS-compliant and/or Pb-free versions of Freescale products have the functionality and electrical characteristics of their non-RoHS-compliant and/or non-Pb-free counterparts. For further information, see <http://www.freescale.com> or contact your Freescale sales representative.

For information on Freescale's Environmental Products program, go to <http://www.freescale.com/epp>.

