

The RF Line

NPN Silicon

RF Power Transistor

... designed for 24 Volt UHF large-signal, common base amplifier applications in industrial and commercial FM equipment operating in the range of 850–960 MHz.

- Motorola Advanced Amplifier Concept Package
- Specified 24 Volt, 900 MHz Characteristics
 - Output Power = 60 Watts
 - Power Gain = 7.0 dB Min
 - Efficiency = 60% Min
- Double Input/Output Matched for Wideband Performance and Simplified External Matching
- Series Equivalent Large-Signal Characterization
- Gold Metallized, Emitter Ballasted for Long Life and Resistance to Metal Migration
- Silicon Nitride Passivated
- Circuit board photomaster available upon request by contacting RF Tactical Marketing in Phoenix, AZ.

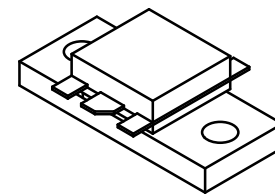
MRF898
60 W, 850–960 MHz
RF POWER
TRANSISTOR
NPN SILICON

CASE 333A-02, STYLE 1

MAXIMUM RATINGS

Rating	Symbol	Value	Unit
Collector–Emitter Voltage	V_{CEO}	30	Vdc
Collector–Base Voltage	V_{CBO}	55	Vdc
Emitter–Base Voltage	V_{EBO}	4.0	Vdc
Collector Current — Continuous	I_C	10	Adc
Total Device Dissipation @ $T_C = 25^\circ\text{C}$ Derate above 25°C	P_D	175 1.0	Watts W/ $^\circ\text{C}$
Storage Temperature Range	T_{stg}	–65 to +150	$^\circ\text{C}$

THERMAL CHARACTERISTICS

Characteristic	Symbol	Max	Unit
Thermal Resistance, Junction to Case	$R_{\theta JC}$	1.0	$^\circ\text{C/W}$

ELECTRICAL CHARACTERISTICS ($T_C = 25^\circ\text{C}$ unless otherwise noted.)

Characteristic	Symbol	Min	Typ	Max	Unit
----------------	--------	-----	-----	-----	------

OFF CHARACTERISTICS

Collector–Emitter Breakdown Voltage ($I_C = 50$ mAdc, $I_B = 0$)	$V_{(BR)CEO}$	30	—	—	Vdc
Collector–Emitter Breakdown Voltage ($I_C = 50$ mAdc, $V_{BE} = 0$)	$V_{(BR)CES}$	55	—	—	Vdc
Emitter–Base Breakdown Voltage ($I_E = 5.0$ mAdc, $I_C = 0$)	$V_{(BR)EBO}$	4.0	—	—	Vdc
Collector Cutoff Current ($V_{CE} = 30$ Vdc, $V_{BE} = 0$, $T_C = 25^\circ\text{C}$)	I_{CES}	—	—	10	mAdc

(continued)

REV 6

© Motorola, Inc. 1994

MOTOROLA

www.DataSheet4U.com

www.DataSheet4U.com

ELECTRICAL CHARACTERISTICS — continued ($T_C = 25^\circ\text{C}$ unless otherwise noted.)

Characteristic	Symbol	Min	Typ	Max	Unit
ON CHARACTERISTICS					
DC Current Gain ($I_C = 2.0 \text{ Adc}$, $V_{CE} = 5.0 \text{ Vdc}$)	h_{FE}	20	50	150	—
DYNAMIC CHARACTERISTICS					
Output Capacitance (1) ($V_{CB} = 24 \text{ Vdc}$, $I_E = 0$, $f = 1.0 \text{ MHz}$)	C_{ob}	—	60	—	pF
FUNCTIONAL TESTS					
Common-Base Amplifier Power Gain ($V_{CC} = 24 \text{ Vdc}$, $P_{out} = 60 \text{ W}$, $f = 900 \text{ MHz}$)	G_{pb}	7.0	7.9	—	dB
Collector Efficiency ($V_{CC} = 24 \text{ Vdc}$, $P_{out} = 60 \text{ W}$, $f = 900 \text{ MHz}$)	η	60	65	—	%
Output Mismatch Stress ($V_{CC} = 24 \text{ Vdc}$, $P_{out} = 60 \text{ W}$, $f = 900 \text{ MHz}$, $VSWR = 5:1$, all phase angles)	ψ	No Degradation in Output Power			

NOTE:

- Value of " C_{ob} " is that of die only. It is not measurable in MRF898 because of internal matching network.

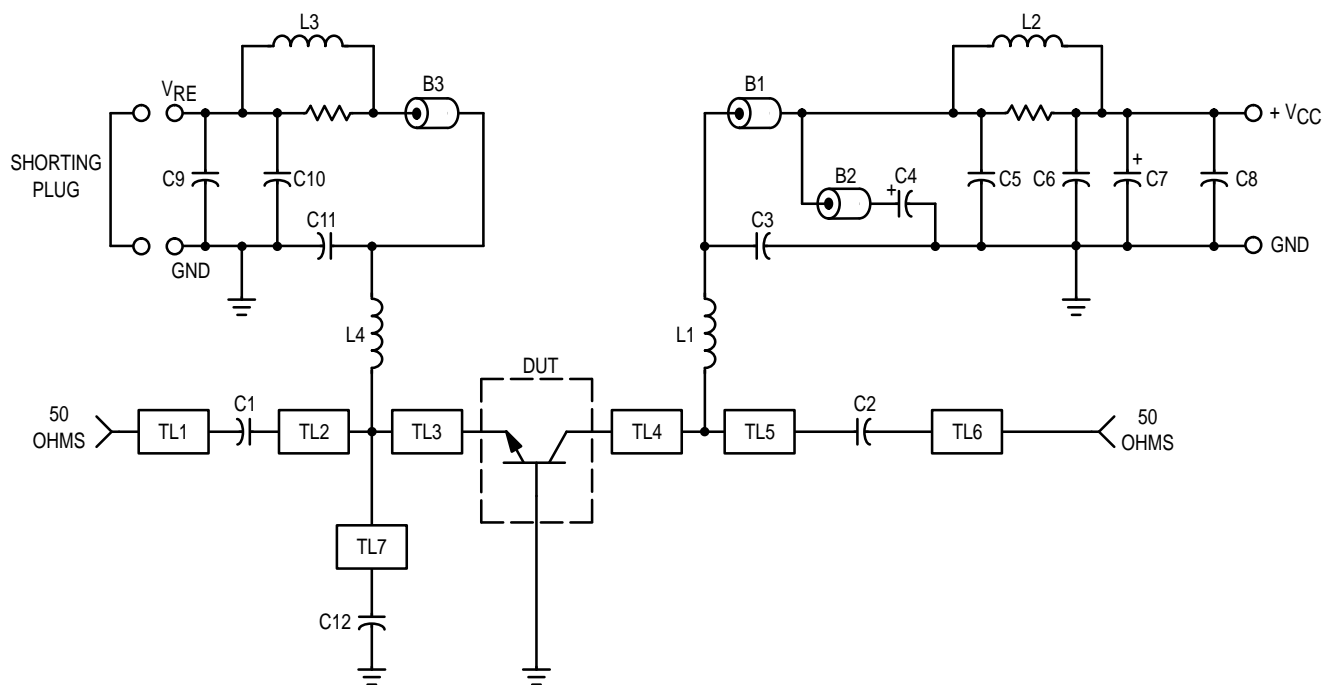

B1, B2, B3 — Bead, Ferroxcube 56-390-65/3B
 C1, C2, C12 — 39 pF, 100 Mil Chip Capacitor
 C3, C11 — 91 pF, Mini Underwood or Equivalent
 C4, C7, C9 — 10 μF , 35 V Electrolytic
 C5 — 4000 pF, 1.0 kV Ceramic
 C6, C10 — 1000 pF, 350 V Unelco or Equivalent
 C8 — 47 pF, 100 Mil Chip Capacitor
 L1, L4 — 4 Turns #18 AWG Choke
 L2 — 11 Turns #20 AWG Choke on 10 Ohm, 1.0 Watt Resistor
 L3 — 3 Turns #18 AWG Choke on 10 Ohm, 1.0 Watt Resistor

TL1, TL6 — 50 Ohm Microstrip
 TL2 — 400 x 950 Mils
 TL3, TL4 — 140 x 200 Mils
 TL5 — 320 x 690 Mils
 TL7 — 260 x 230 Mils
 Board — 3M Epsilam-10, 50 Mil
 Bias Boards — 1/32" G10 or Equivalent

Figure 1. 850-960 MHz Broadband Test Circuit

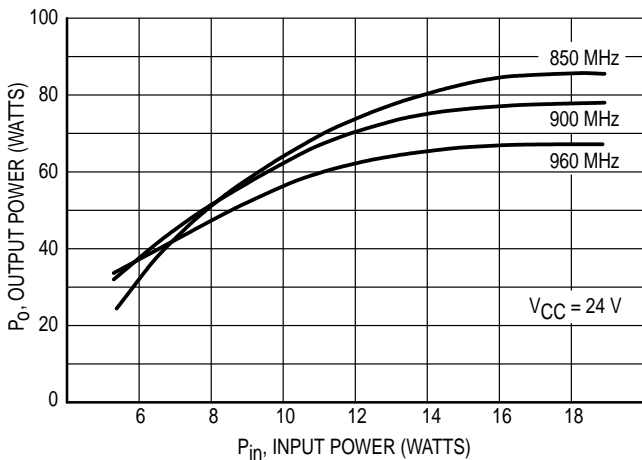

Figure 2. Output Power versus Input Power

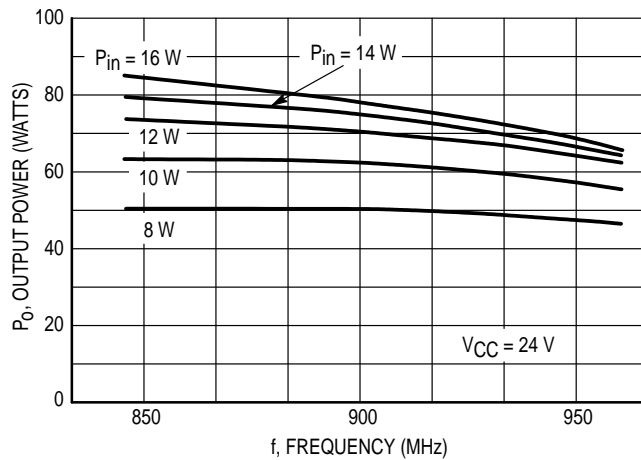

Figure 3. Output Power versus Frequency

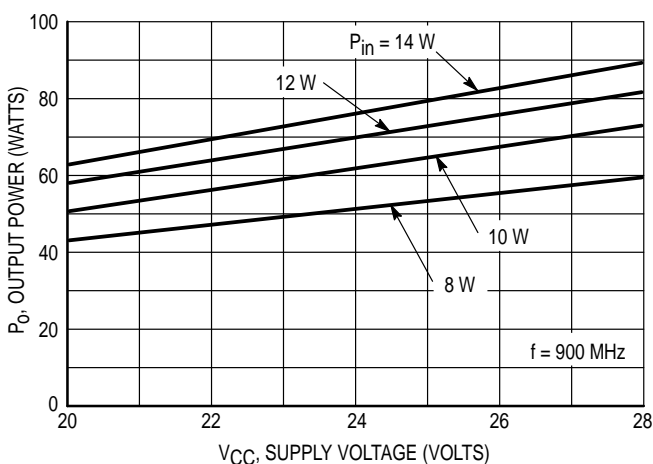

Figure 4. Output Power versus Supply Voltage

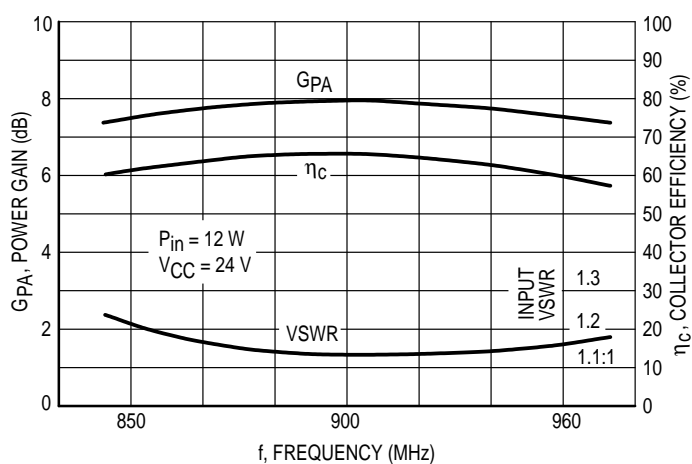

Figure 5. Typical Broadband Circuit Performance

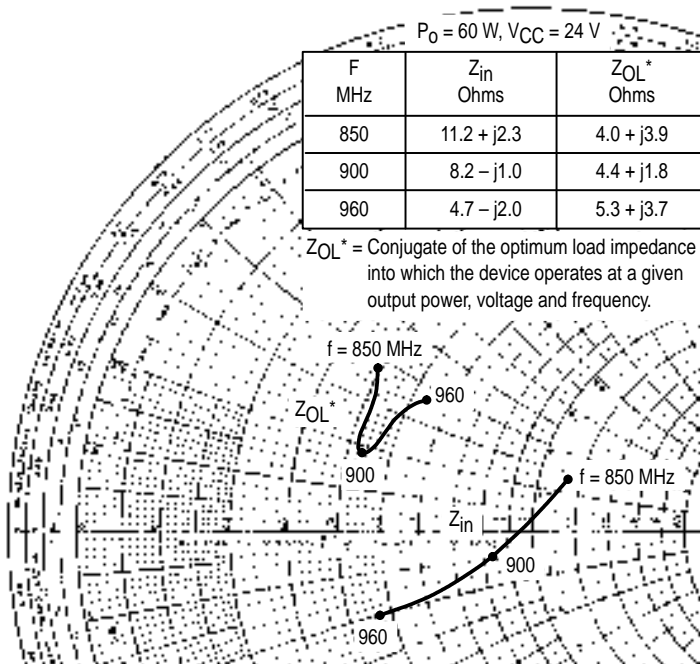
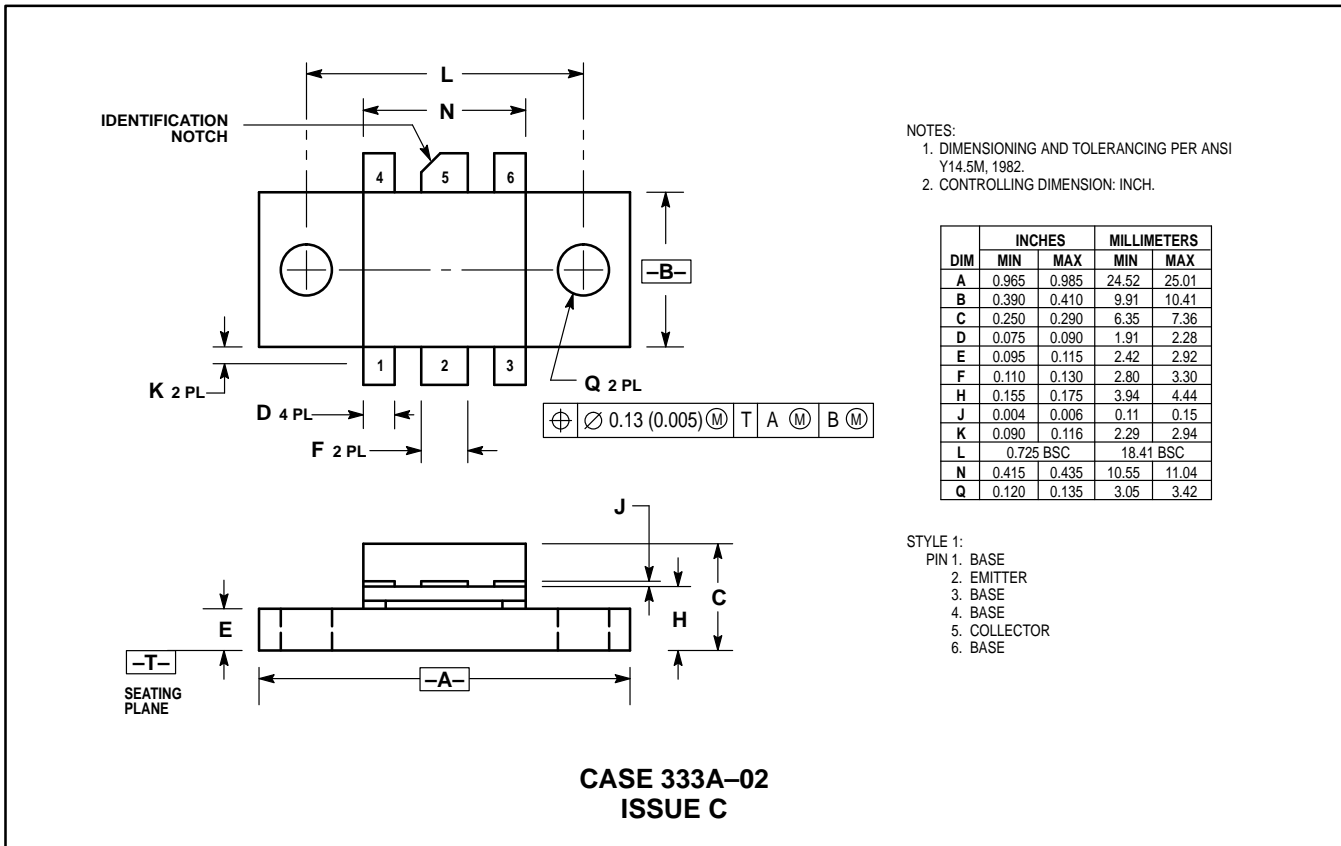

Figure 6. Input/Output Impedance versus Frequency

PACKAGE DIMENSIONS



NOTES:
 1. DIMENSIONING AND TOLERANCING PER ANSI Y14.5M, 1982.
 2. CONTROLLING DIMENSION: INCH.

DIM	INCHES		MILLIMETERS	
	MIN	MAX	MIN	MAX
A	0.965	0.985	24.52	25.01
B	0.390	0.410	9.91	10.41
C	0.250	0.290	6.35	7.36
D	0.075	0.090	1.91	2.28
E	0.095	0.115	2.42	2.92
F	0.110	0.130	2.80	3.30
H	0.155	0.175	3.94	4.44
J	0.004	0.006	0.11	0.15
K	0.090	0.116	2.29	2.94
L	0.725 BSC		18.41 BSC	
N	0.415	0.435	10.55	11.04
Q	0.120	0.135	3.05	3.42

STYLE 1:
 PIN 1. BASE
 2. EMITTER
 3. BASE
 4. BASE
 5. COLLECTOR
 6. BASE

\oplus	$\varnothing 0.13 (0.005) \text{ (M)}$	T	A	(M)	B	(M)
----------	--	---	---	-----	---	-----

Motorola reserves the right to make changes without further notice to any products herein. Motorola makes no warranty, representation or guarantee regarding the suitability of its products for any particular purpose, nor does Motorola assume any liability arising out of the application or use of any product or circuit, and specifically disclaims any and all liability, including without limitation consequential or incidental damages. "Typical" parameters can and do vary in different applications. All operating parameters, including "Typicals" must be validated for each customer application by customer's technical experts. Motorola does not convey any license under its patent rights nor the rights of others. Motorola products are not designed, intended, or authorized for use as components in systems intended for surgical implant into the body, or other applications intended to support or sustain life, or for any other application in which the failure of the Motorola product could create a situation where personal injury or death may occur. Should Buyer purchase or use Motorola products for any such unintended or unauthorized application, Buyer shall indemnify and hold Motorola and its officers, employees, subsidiaries, affiliates, and distributors harmless against all claims, costs, damages, and expenses, and reasonable attorney fees arising out of, directly or indirectly, any claim of personal injury or death associated with such unintended or unauthorized use, even if such claim alleges that Motorola was negligent regarding the design or manufacture of the part. Motorola and are registered trademarks of Motorola, Inc. Motorola, Inc. is an Equal Opportunity/Affirmative Action Employer.

Literature Distribution Centers:

USA: Motorola Literature Distribution; P.O. Box 20912; Phoenix, Arizona 85036.
 EUROPE: Motorola Ltd.; European Literature Centre; 88 Tanners Drive, Blakelands, Milton Keynes, MK14 5BP, England.
 JAPAN: Nippon Motorola Ltd.; 4-32-1, Nishi-Gotanda, Shinagawa-ku, Tokyo 141, Japan.
 ASIA PACIFIC: Motorola Semiconductors H.K. Ltd.; Silicon Harbour Center, No. 2 Dai King Street, Tai Po Industrial Estate, Tai Po, N.T., Hong Kong.

