

# RF Power Field Effect Transistors

## N-Channel Enhancement-Mode Lateral MOSFETs

Designed for W-CDMA and LTE base station applications with frequencies from 2110 to 2170 MHz. Can be used in Class AB and Class C for all typical cellular base station modulation formats.

- Typical Single-Carrier W-CDMA Performance:  $V_{DD} = 28$  Volts,  $I_{DQ} = 970$  mA,  $P_{out} = 34$  Watts Avg., IQ Magnitude Clipping, Channel Bandwidth = 3.84 MHz, Input Signal PAR = 7.5 dB @ 0.01% Probability on CCDF.

Frequency	$G_{ps}$ (dB)	$\eta_D$ (%)	Output PAR (dB)	ACPR (dBc)
2110 MHz	17.7	32.1	6.2	-37.0
2140 MHz	17.9	31.7	6.4	-37.5
2170 MHz	18.1	31.7	6.4	-37.5

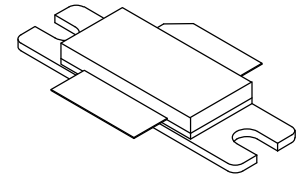
- Capable of Handling 10:1 VSWR, @ 32 Vdc, 2140 MHz, 188 Watts CW (1) Output Power (3 dB Input Overdrive from Rated  $P_{out}$ )
- Typical  $P_{out}$  @ 1 dB Compression Point = 126 Watts CW

### Features

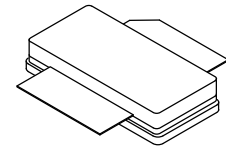
- 100% PAR Tested for Guaranteed Output Power Capability
- Characterized with Series Equivalent Large-Signal Impedance Parameters and Common Source S-Parameters
- Internally Matched for Ease of Use
- Integrated ESD Protection
- Greater Negative Gate-Source Voltage Range for Improved Class C Operation
- Designed for Digital Predistortion Error Correction Systems
- Optimized for Doherty Applications
- RoHS Compliant
- In Tape and Reel. R3 Suffix = 250 Units per 56 mm, 13 inch Reel.

**MRF8S21140HR3**  
**MRF8S21140HSR3**

**2110-2170 MHz, 34 W AVG., 28 V**  
**W-CDMA, LTE**  
**LATERAL N-CHANNEL**  
**RF POWER MOSFETs**



**CASE 465-06, STYLE 1**  
**NI-780**  
**MRF8S21140HR3**



**CASE 465A-06, STYLE 1**  
**NI-780S**  
**MRF8S21140HSR3**

**Table 1. Maximum Ratings**

Rating	Symbol	Value	Unit
Drain-Source Voltage	$V_{DSS}$	-0.5, +65	Vdc
Gate-Source Voltage	$V_{GS}$	-6.0, +10	Vdc
Operating Voltage	$V_{DD}$	32, +0	Vdc
Storage Temperature Range	$T_{stg}$	-65 to +150	°C
Case Operating Temperature	$T_C$	150	°C
Operating Junction Temperature (2,3)	$T_J$	225	°C
CW Operation @ $T_C = 25^\circ\text{C}$ Derate above 25°C	CW	168 0.86	W W/°C

**Table 2. Thermal Characteristics**

Characteristic	Symbol	Value (3,4)	Unit
Thermal Resistance, Junction to Case Case Temperature 75°C, 34 W CW, 28 Vdc, $I_{DQ} = 970$ mA, 2140 MHz	$R_{\theta JC}$	0.47	°C/W
Case Temperature 80°C, 150 W CW(1), 28 Vdc, $I_{DQ} = 970$ mA, 2140 MHz		0.42	

1. Exceeds recommended operating conditions. See CW operation data in Maximum Ratings table.
2. Continuous use at maximum temperature will affect MTTF.
3. MTTF calculator available at <http://www.freescale.com/rf>. Select Software & Tools/Development Tools/Calculators to access MTTF calculators by product.
4. Refer to AN1955, *Thermal Measurement Methodology of RF Power Amplifiers*. Go to <http://www.freescale.com/rf>. Select Documentation/Application Notes - AN1955.

**Table 3. ESD Protection Characteristics**

Test Methodology	Class
Human Body Model (per JESD22-A114)	2 (Minimum)
Machine Model (per EIA/JESD22-A115)	A (Minimum)
Charge Device Model (per JESD22-C101)	IV (Minimum)

**Table 4. Electrical Characteristics** ( $T_A = 25^\circ\text{C}$  unless otherwise noted)

Characteristic	Symbol	Min	Typ	Max	Unit
<b>Off Characteristics</b>					
Zero Gate Voltage Drain Leakage Current ( $V_{DS} = 65\text{ Vdc}$ , $V_{GS} = 0\text{ Vdc}$ )	$I_{DSS}$	—	—	10	$\mu\text{Adc}$
Zero Gate Voltage Drain Leakage Current ( $V_{DS} = 28\text{ Vdc}$ , $V_{GS} = 0\text{ Vdc}$ )	$I_{DSS}$	—	—	1	$\mu\text{Adc}$
Gate-Source Leakage Current ( $V_{GS} = 5\text{ Vdc}$ , $V_{DS} = 0\text{ Vdc}$ )	$I_{GSS}$	—	—	1	$\mu\text{Adc}$

**On Characteristics**

Gate Threshold Voltage ( $V_{DS} = 10\text{ Vdc}$ , $I_D = 200\ \mu\text{Adc}$ )	$V_{GS(th)}$	1.0	1.8	2.5	Vdc
Gate Quiescent Voltage ( $V_{DS} = 28\text{ Vdc}$ , $I_D = 970\ \text{mAdc}$ )	$V_{GS(Q)}$	—	2.6	—	Vdc
Fixture Gate Quiescent Voltage <sup>(1)</sup> ( $V_{DD} = 28\text{ Vdc}$ , $I_D = 970\ \text{mAdc}$ , Measured in Functional Test)	$V_{GG(Q)}$	3.8	5.2	6.8	Vdc
Drain-Source On-Voltage ( $V_{GS} = 10\text{ Vdc}$ , $I_D = 3\text{ Adc}$ )	$V_{DS(on)}$	0.1	0.18	0.3	Vdc

**Functional Tests <sup>(2)</sup>** (In Freescale Test Fixture, 50 ohm system)  $V_{DD} = 28\text{ Vdc}$ ,  $I_{DQ} = 970\ \text{mA}$ ,  $P_{out} = 34\ \text{W Avg.}$ ,  $f = 2140\ \text{MHz}$ , Single-Carrier W-CDMA, IQ Magnitude Clipping, Input Signal PAR = 7.5 dB @ 0.01% Probability on CCDF. ACPR measured in 3.84 MHz Channel Bandwidth @  $\pm 5\ \text{MHz}$  Offset.

Power Gain	$G_{ps}$	16.7	17.9	19.7	dB
Drain Efficiency	$\eta_D$	29.7	31.7	—	%
Output Peak-to-Average Ratio @ 0.01% Probability on CCDF	PAR	5.9	6.4	—	dB
Adjacent Channel Power Ratio	ACPR	—	-37.5	-36	dBc
Input Return Loss	IRL	—	-16	-7	dB

**Typical Broadband Performance** (In Freescale Test Fixture, 50 ohm system)  $V_{DD} = 28\text{ Vdc}$ ,  $I_{DQ} = 970\ \text{mA}$ ,  $P_{out} = 34\ \text{W Avg.}$ , Single-Carrier W-CDMA, IQ Magnitude Clipping, Input Signal PAR = 7.5 dB @ 0.01% Probability on CCDF. ACPR measured in 3.84 MHz Channel Bandwidth @  $\pm 5\ \text{MHz}$  Offset.

Frequency	$G_{ps}$ (dB)	$\eta_D$ (%)	Output PAR (dB)	ACPR (dBc)	IRL (dB)
2110 MHz	17.7	32.1	6.2	-37.0	-17
2140 MHz	17.9	31.7	6.4	-37.5	-16
2170 MHz	18.1	31.7	6.4	-37.5	-16

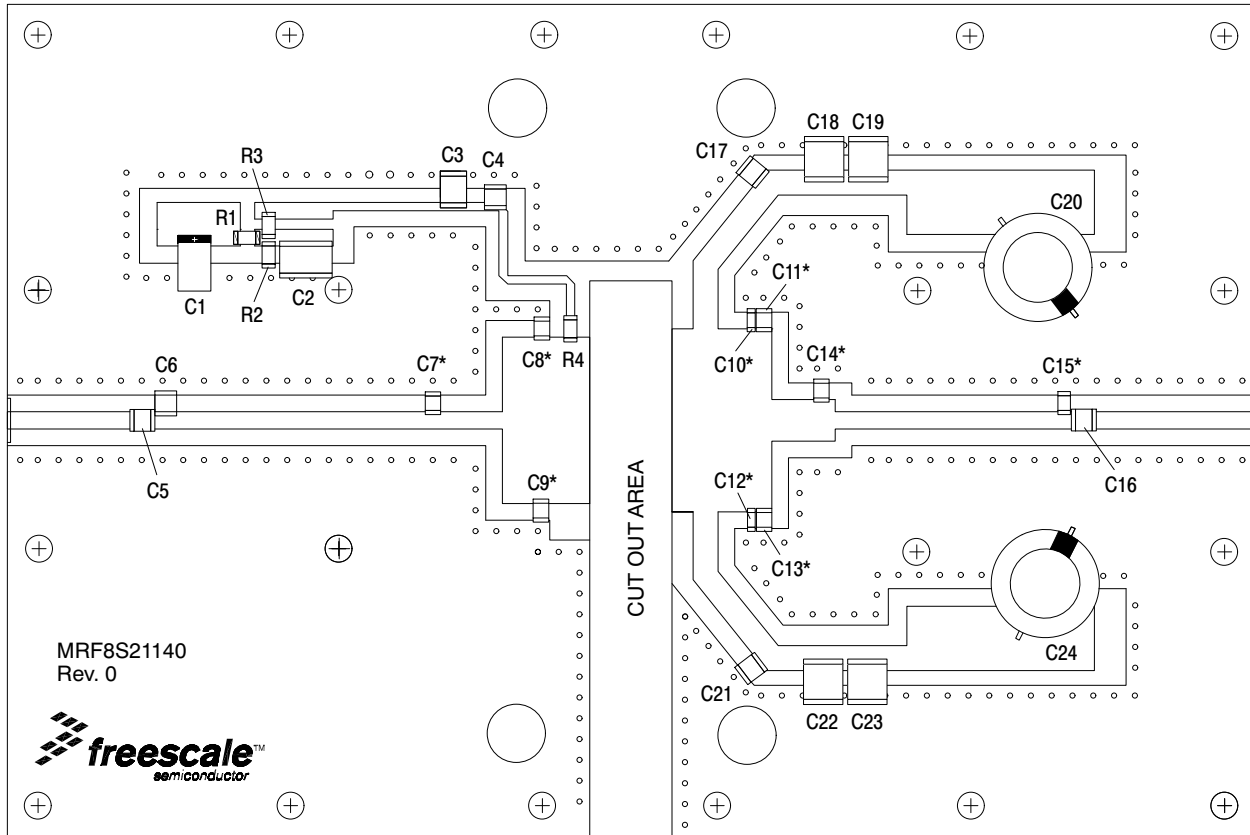
- $V_{GG} = 2 \times V_{GS(Q)}$ . Parameter measured on Freescale Test Fixture, due to resistive divider network on the board. Refer to Test Circuit schematic.
- Part internally matched both on input and output.

(continued)

**Table 4. Electrical Characteristics** ( $T_A = 25^\circ\text{C}$  unless otherwise noted) (continued)

Characteristic	Symbol	Min	Typ	Max	Unit
<b>Typical Performances</b> (In Freescale Test Fixture, 50 ohm system) $V_{DD} = 28\text{ Vdc}$ , $I_{DQ} = 970\text{ mA}$ , 2110-2170 MHz Bandwidth					
$P_{out}$ @ 1 dB Compression Point, CW	P1dB	—	126	—	W
IMD Symmetry @ 55 W PEP, $P_{out}$ where IMD Third Order Intermodulation $\cong 30\text{ dBc}$ (Delta IMD Third Order Intermodulation between Upper and Lower Sidebands $> 2\text{ dB}$ )	IMD <sub>sym</sub>	—	10	—	MHz
VBW Resonance Point (IMD Third Order Intermodulation Inflection Point)	VBW <sub>res</sub>	—	53	—	MHz
Gain Flatness in 60 MHz Bandwidth @ $P_{out} = 34\text{ W Avg.}$	$G_F$	—	0.5	—	dB
Gain Variation over Temperature (-30 °C to +85°C)	$\Delta G$	—	0.016	—	dB/°C
Output Power Variation over Temperature (-30 °C to +85°C)	$\Delta P_{1dB}$	—	0.018 (1)	—	dBm/°C

1. Exceeds recommended operating conditions. See CW operation data in Maximum Ratings table.



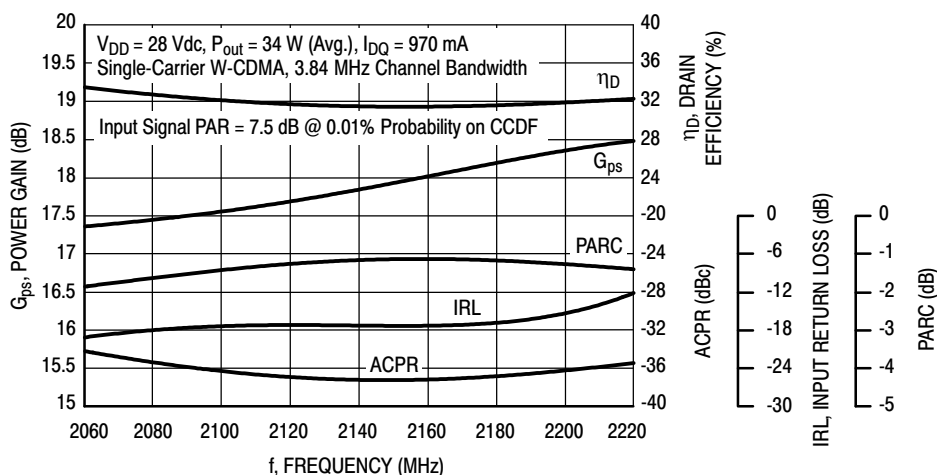
\*C7, C8, C9, C10, C11, C12, C13, C14, and C15 are mounted vertically.

**Figure 1. MRF8S21140HR3(HSR3) Test Circuit Component Layout**

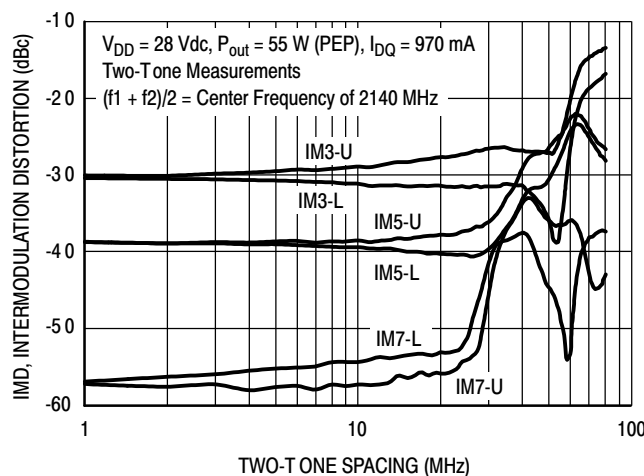
**Table 5. MRF8S21140HR3(HSR3) Test Circuit Component Designations and Values**

Part	Description	Part Number	Manufacturer
C1	10 $\mu$ F Chip Capacitor	T491D106K055AT	Kemet
C2	0.01 $\mu$ F Chip Capacitor	C1825C103K1GAC	Kemet
C3	4.7 $\mu$ F Chip Capacitor	GRM43ER61H475MA88L	Murata
C4, C17, C21	6.8 pF Chip Capacitors	ATC100B6R8CT500XT	ATC
C5, C16	11 pF Chip Capacitors	ATC100B110JT500XT	ATC
C6	0.5 pF Chip Capacitor	ATC100B0R5BT500XT	ATC
C7	1.2 pF Chip Capacitor	ATC100B1R2BT500XT	ATC
C8, C9, C11, C13, C14	0.3 pF Chip Capacitors	ATC100B0R3BT500XT	ATC
C10, C12	0.1 pF Chip Capacitors	ATC100B0R1BT500XT	ATC
C15	0.2 pF Chip Capacitor	ATC100B0R2BT500XT	ATC
C18, C19, C22, C23	10 $\mu$ F Chip Capacitors	GRM55DR61H106KA88L	Murata
C20, C24	470 $\mu$ F, 63 V Electrolytic Capacitors	MCGPR63V477M13X26-RH	Multicomp
R1, R2	2 k $\Omega$ , 1/4 W Chip Resistors	CRCW12062K00FKEA	Vishay
R3	0 $\Omega$ , 3.5 A Chip Resistor	CRCW12060000Z0EA	Vishay
R4	2.37 $\Omega$ , 1/4 W Chip Resistor	CRCW12062R37FNEA	Vishay
PCB	0.030", $\epsilon_r = 2.55$	AD255A	Arlon

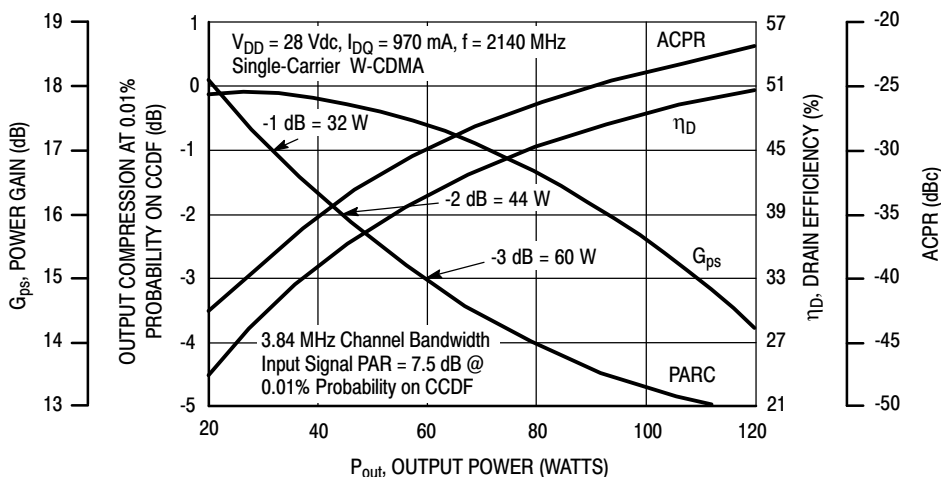
### TYPICAL CHARACTERISTICS



**Figure 2. Output Peak-to-Average Ratio Compression (PARC) Broadband Performance @  $P_{out} = 34$  Watts Avg.**

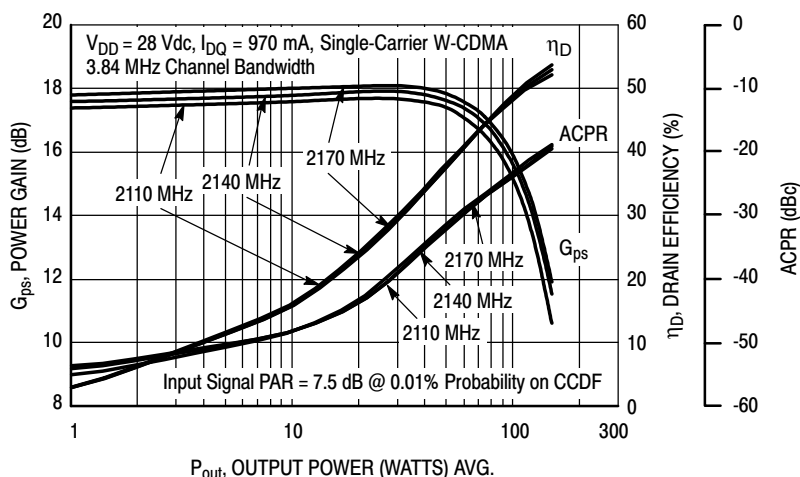


**Figure 3. Intermodulation Distortion Products versus Two-Tone Spacing**

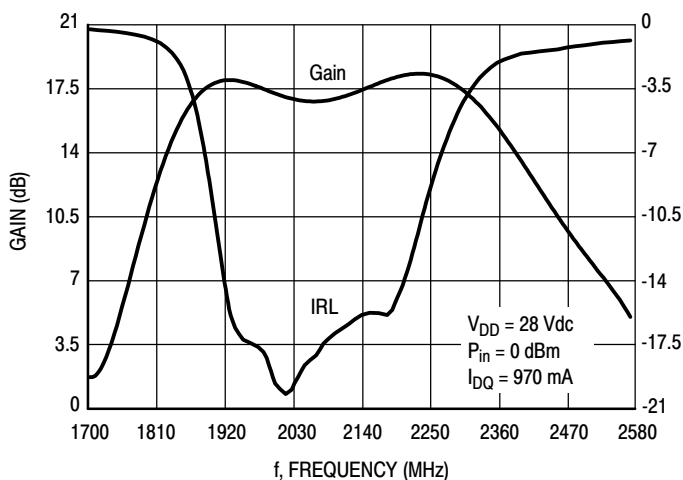


**Figure 4. Output Peak-to-Average Ratio Compression (PARC) versus Output Power**

### TYPICAL CHARACTERISTICS

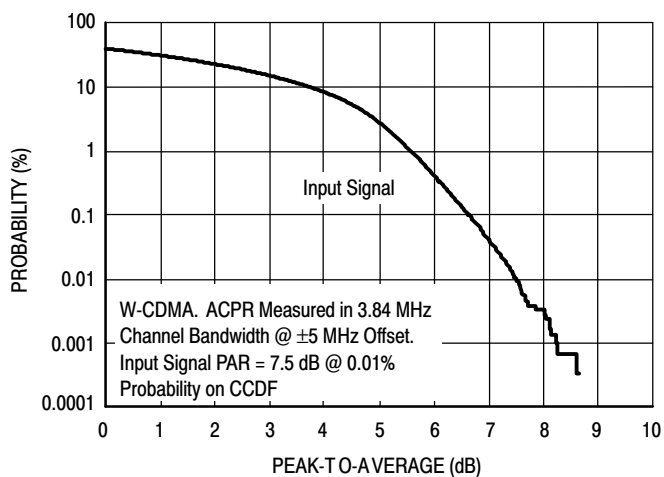


**Figure 5. Single-Carrier W-CDMA Power Gain, Drain Efficiency and ACPR versus Output Power**

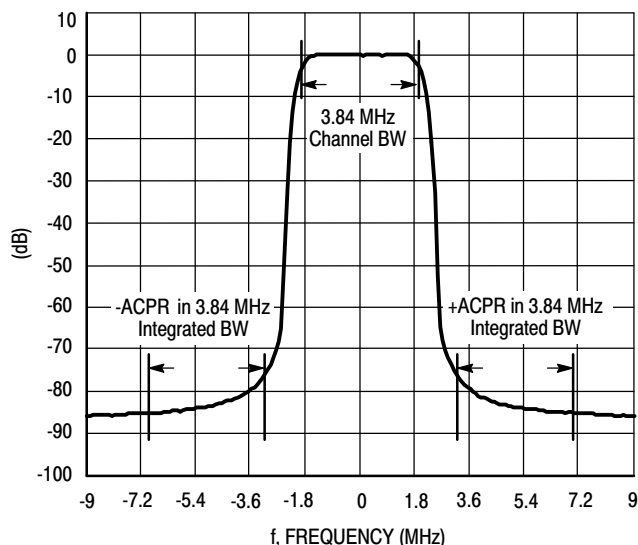


**Figure 6. Broadband Frequency Response**

### W-CDMA TEST SIGNAL



**Figure 7. CCDF W-CDMA IQ Magnitude Clipping, Single-Carrier Test Signal**



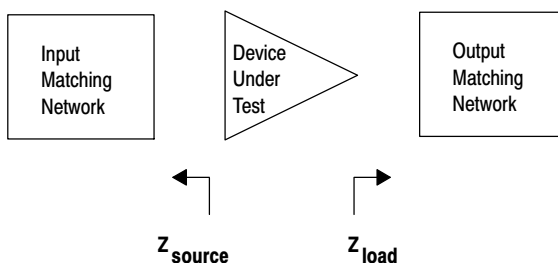
**Figure 8. Single-Carrier W-CDMA Spectrum**

$V_{DD} = 28 \text{ Vdc}$ ,  $I_{DQ} = 970 \text{ mA}$ ,  $P_{out} = 34 \text{ W Avg.}$

f MHz	$Z_{source}$ $\Omega$	$Z_{load}$ $\Omega$
2060	5.09 - j3.45	1.78 - j4.17
2080	5.35 - j3.20	1.75 - j4.06
2100	5.64 - j3.01	1.72 - j3.98
2120	6.01 - j2.86	1.72 - j3.92
2140	6.42 - j2.72	1.73 - j3.83
2160	6.82 - j2.62	1.75 - j3.71
2180	7.25 - j2.62	1.75 - j3.62
2200	7.76 - j2.73	1.76 - j3.54
2220	8.28 - j2.87	1.77 - j3.43

$Z_{source}$  = Test circuit impedance as measured from gate to ground.

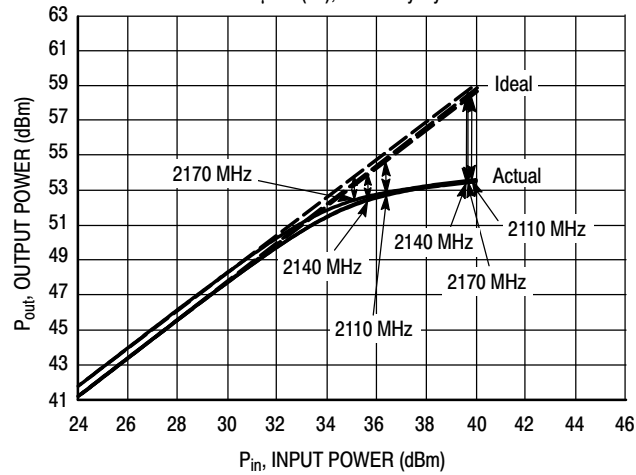
$Z_{load}$  = Test circuit impedance as measured from drain to ground.



**Figure 9. Series Equivalent Source and Load Impedance**

## ALTERNATIVE PEAK TUNE LOAD PULL CHARACTERISTICS

$V_{DD} = 28 \text{ Vdc}$ ,  $I_{DQ} = 970 \text{ mA}$ , Pulsed CW,  
 $10 \mu\text{sec(ON)}$ , 10% Duty Cycle



NOTE: Load Pull Test Fixture Tuned for Peak P1dB Output Power @ 28 V

f (MHz)	P1dB		P3dB	
	Watts	dBm	Watts	dBm
2110	191	52.8	232	53.7
2140	182	52.6	219	53.4
2170	179	52.5	216	53.3

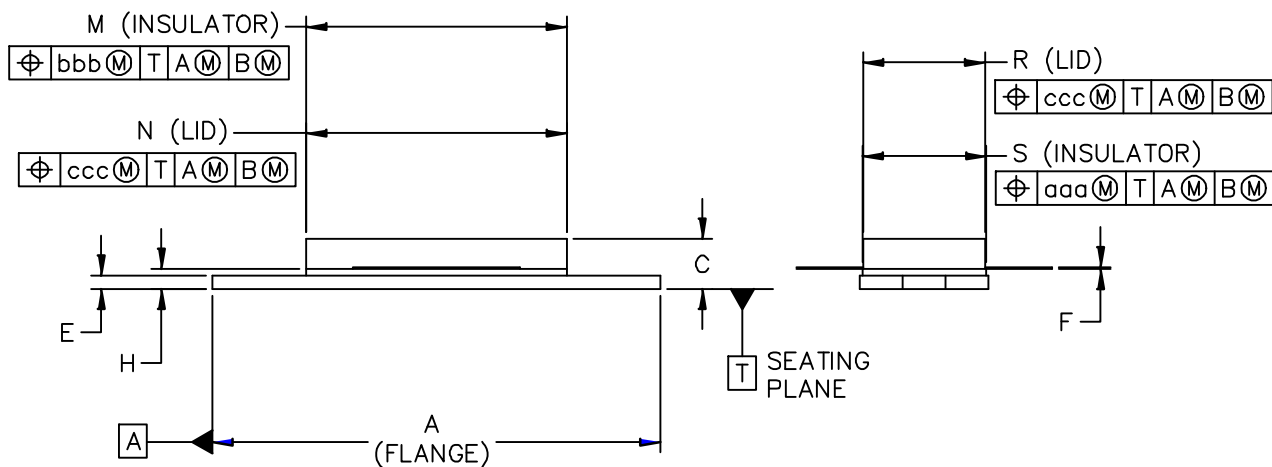
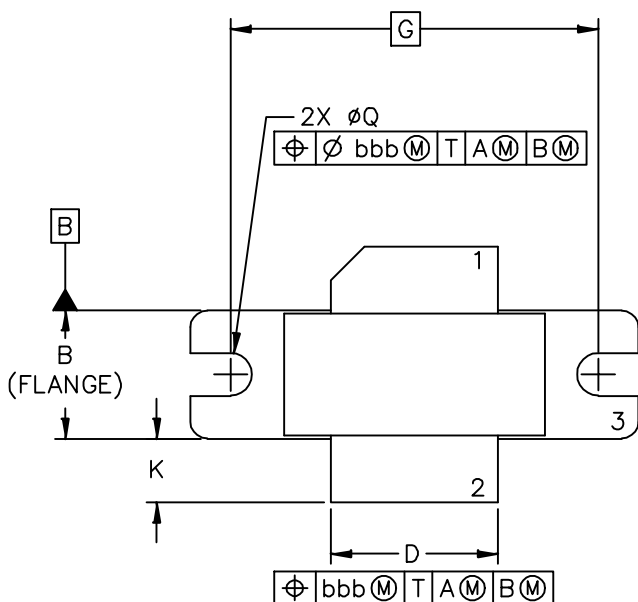
Test Impedances per Compression Level

f (MHz)		$Z_{\text{source}}$ $\Omega$	$Z_{\text{load}}$ $\Omega$
2110	P1dB	$6.74 - j4.91$	$0.95 - j2.96$
2140	P1dB	$8.26 - j6.27$	$0.98 - j3.02$
2170	P1dB	$8.34 - j0.34$	$1.07 - j2.82$

**Figure 10. Pulsed CW Output Power versus Input Power @ 28 V**



### PACKAGE DIMENSIONS



© FREESCALE SEMICONDUCTOR, INC. ALL RIGHTS RESERVED.		<b>MECHANICAL OUTLINE</b>		PRINT VERSION NOT TO SCALE	
TITLE:  NI-780		DOCUMENT NO: 98ASB15607C		REV: G	
		CASE NUMBER: 465-06		31 MAR 2005	
		STANDARD: NON-JEDEC			

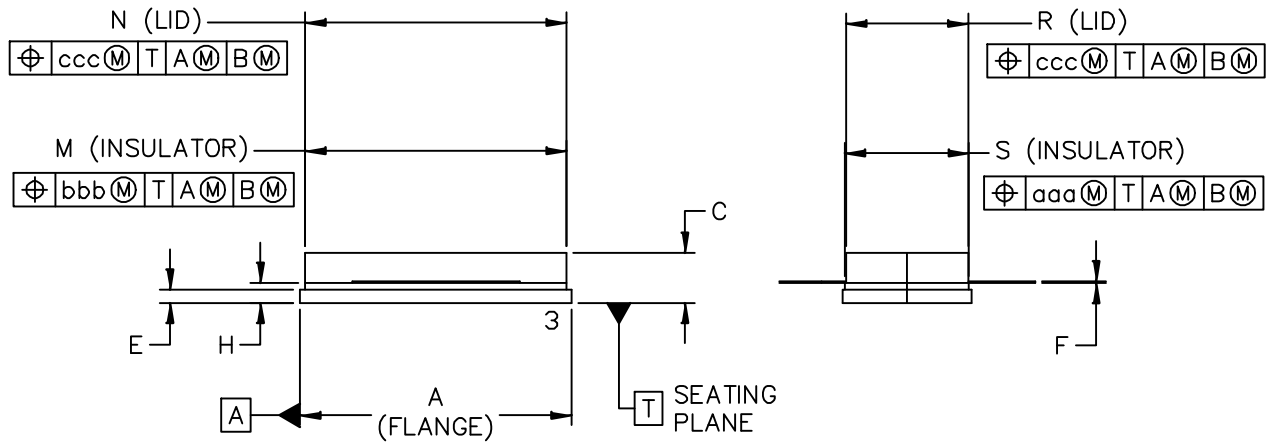
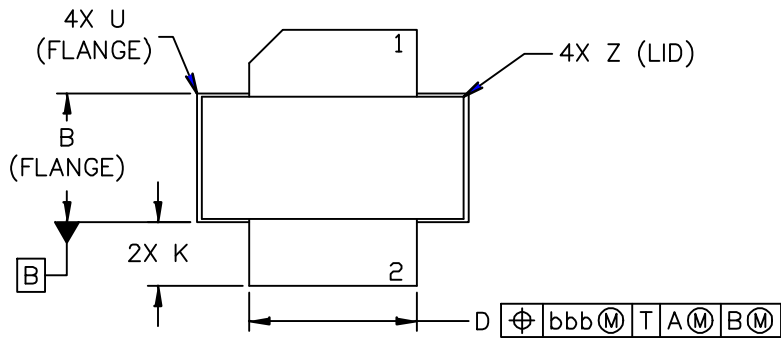
NOTES:

1. DIMENSIONING AND TOLERANCING PER ANSI Y14.5M-1994.
2. CONTROLLING DIMENSION: INCH.
3. DELETED
4. DIMENSION H IS MEASURED .030 (.762) AWAY FROM PACKAGE BODY.

STYLE 1:

- PIN 1. DRAIN  
 2. GATE  
 3. SOURCE

DIM	INCH		MILLIMETER		DIM	INCH		MILLIMETER	
	MIN	MAX	MIN	MAX		MIN	MAX	MIN	MAX
A	1.335	– 1.345	33.91	– 34.16	R	.365	– .375	9.27	– 9.53
B	.380	– .390	9.65	– 9.91	S	.365	– .375	9.27	– 9.52
C	.125	– .170	3.18	– 4.32	aaa	– .005	–	–	0.127 –
D	.495	– .505	12.57	– 12.83	bbb	– .010	–	–	0.254 –
E	.035	– .045	0.89	– 1.14	ccc	– .015	–	–	0.381 –
F	.003	– .006	0.08	– 0.15	–	–	–	–	–
G	1.100 BSC		27.94 BSC		–	–	–	–	–
H	.057	– .067	1.45	– 1.7	–	–	–	–	–
K	.170	– .210	4.32	– 5.33	–	–	–	–	–
M	.774	– .786	19.66	– 19.96	–	–	–	–	–
N	.772	– .788	19.6	– 20	–	–	–	–	–
Q	∅.118	– ∅.138	∅3	– ∅3.51	–	–	–	–	–
© FREESCALE SEMICONDUCTOR, INC. ALL RIGHTS RESERVED.			<b>MECHANICAL OUTLINE</b>			PRINT VERSION NOT TO SCALE			
TITLE:  NI-780					DOCUMENT NO: 98ASB15607C			REV: G	
					CASE NUMBER: 465-06			31 MAR 2005	
					STANDARD: NON-JEDEC				



© FREESCALE SEMICONDUCTOR, INC. ALL RIGHTS RESERVED.	<b>MECHANICAL OUTLINE</b>	PRINT VERSION NOT TO SCALE	
TITLE:  NI-780S	DOCUMENT NO: 98ASB16718C	REV: H	
	CASE NUMBER: 465A-06	31 MAR 2005	
	STANDARD: NON-JEDEC		

NOTES:

1. DIMENSIONING AND TOLERANCING PER ANSI Y14.5M–1994.
2. CONTROLLING DIMENSION: INCH.
3. DELETED
4. DIMENSION H IS MEASURED .030 (0.762) AWAY FROM PACKAGE BODY.

STYLE 1:

- PIN 1. DRAIN
2. GATE
3. SOURCE

DIM	INCH		MILLIMETER		DIM	INCH		MILLIMETER	
	MIN	MAX	MIN	MAX		MIN	MAX	MIN	MAX
A	.805	– .815	20.45	– 20.7	U	–	– .040	–	– 1.02
B	.380	– .390	9.65	– 9.91	Z	–	– .030	–	– 0.76
C	.125	– .170	3.18	– 4.32	aaa	–	.005 –	–	0.127 –
D	.495	– .505	12.57	– 12.83	bbb	–	.010 –	–	0.254 –
E	.035	– .045	0.89	– 1.14	ccc	–	.015 –	–	0.381 –
F	.003	– .006	0.08	– 0.15	–	–	– –	–	– –
H	.057	– .067	1.45	– 1.7	–	–	– –	–	– –
K	.170	– .210	4.32	– 5.33	–	–	– –	–	– –
M	.774	– .786	19.61	– 20.02	–	–	– –	–	– –
N	.772	– .788	19.61	– 20.02	–	–	– –	–	– –
R	.365	– .375	9.27	– 9.53	–	–	– –	–	– –
S	.365	– .375	9.27	– 9.52	–	–	– –	–	– –

© FREESCALE SEMICONDUCTOR, INC. ALL RIGHTS RESERVED.		<b>MECHANICAL OUTLINE</b>		PRINT VERSION NOT TO SCALE	
TITLE:  NI–780S		DOCUMENT NO: 98ASB16718C		REV: H	
		CASE NUMBER: 465A–06		31 MAR 2005	
		STANDARD: NON–JEDEC			

## PRODUCT DOCUMENTATION AND SOFTWARE

Refer to the following documents, tools and software to aid your design process.

### Application Notes

- AN1955: Thermal Measurement Methodology of RF Power Amplifiers

### Engineering Bulletins

- EB212: Using Data Sheet Impedances for RF LDMOS Devices

### Software

- Electromigration MTTF Calculator
- RF High Power Model
- .s2p File

For Software, do a Part Number search at <http://www.freescale.com>, and select the “Part Number” link. Go to the Software & Tools tab on the part’s Product Summary page to download the respective tool.

## REVISION HISTORY

The following table summarizes revisions to this document.

Revision	Date	Description
0	May 2010	<ul style="list-style-type: none"> <li>• Initial Release of Data Sheet</li> </ul>

## **How to Reach Us:**

### **Home Page:**

[www.freescale.com](http://www.freescale.com)

### **Web Support:**

<http://www.freescale.com/support>

### **USA/Europe or Locations Not Listed:**

Freescale Semiconductor, Inc.  
Technical Information Center, EL516  
2100 East Elliot Road  
Tempe, Arizona 85284  
1-800-521-6274 or +1-480-768-2130  
[www.freescale.com/support](http://www.freescale.com/support)

### **Europe, Middle East, and Africa:**

Freescale Halbleiter Deutschland GmbH  
Technical Information Center  
Schatzbogen 7  
81829 Muenchen, Germany  
+44 1296 380 456 (English)  
+46 8 52200080 (English)  
+49 89 92103 559 (German)  
+33 1 69 35 48 48 (French)  
[www.freescale.com/support](http://www.freescale.com/support)

### **Japan:**

Freescale Semiconductor Japan Ltd.  
Headquarters  
ARCO Tower 15F  
1-8-1, Shimo-Meguro, Meguro-ku,  
Tokyo 153-0064  
Japan  
0120 191014 or +81 3 5437 9125  
[support.japan@freescale.com](mailto:support.japan@freescale.com)

### **Asia/Pacific:**

Freescale Semiconductor China Ltd.  
Exchange Building 23F  
No. 118 Jianguo Road  
Chaoyang District  
Beijing 100022  
China  
+86 10 5879 8000  
[support.asia@freescale.com](mailto:support.asia@freescale.com)

### **For Literature Requests Only:**

Freescale Semiconductor Literature Distribution Center  
1-800-441-2447 or +1-303-675-2140  
Fax: +1-303-675-2150  
[LDCForFreescaleSemiconductor@hibbertgroup.com](mailto:LDCForFreescaleSemiconductor@hibbertgroup.com)

Information in this document is provided solely to enable system and software implementers to use Freescale Semiconductor products. There are no express or implied copyright licenses granted hereunder to design or fabricate any integrated circuits or integrated circuits based on the information in this document.

Freescale Semiconductor reserves the right to make changes without further notice to any products herein. Freescale Semiconductor makes no warranty, representation or guarantee regarding the suitability of its products for any particular purpose, nor does Freescale Semiconductor assume any liability arising out of the application or use of any product or circuit, and specifically disclaims any and all liability, including without limitation consequential or incidental damages. "Typical" parameters that may be provided in Freescale Semiconductor data sheets and/or specifications can and do vary in different applications and actual performance may vary over time. All operating parameters, including "Typicals", must be validated for each customer application by customer's technical experts. Freescale Semiconductor does not convey any license under its patent rights nor the rights of others. Freescale Semiconductor products are not designed, intended, or authorized for use as components in systems intended for surgical implant into the body, or other applications intended to support or sustain life, or for any other application in which the failure of the Freescale Semiconductor product could create a situation where personal injury or death may occur. Should Buyer purchase or use Freescale Semiconductor products for any such unintended or unauthorized application, Buyer shall indemnify and hold Freescale Semiconductor and its officers, employees, subsidiaries, affiliates, and distributors harmless against all claims, costs, damages, and expenses, and reasonable attorney fees arising out of, directly or indirectly, any claim of personal injury or death associated with such unintended or unauthorized use, even if such claim alleges that Freescale Semiconductor was negligent regarding the design or manufacture of the part.

Freescale™ and the Freescale logo are trademarks of Freescale Semiconductor, Inc. All other product or service names are the property of their respective owners.

© Freescale Semiconductor, Inc. 2010. All rights reserved.