

The RF Sub-Micron MOSFET Line
RF Power Field Effect Transistors
N-Channel Enhancement-Mode Lateral MOSFETs

MRF9130LR3
MRF9130LSR3

Designed for GSM and GSM EDGE base station applications with frequencies from 921 to 960 MHz, the high gain and broadband performance of these devices make them ideal for large-signal, common-source amplifier applications in 28 volt base station equipment.

- Typical Performance for GSM Frequencies, 921 to 960 MHz, 28 Volts
 Output Power @ P1dB — 135 Watts
 Power Gain — 16.5 dB @ 130 Watts Output Power
 Efficiency — 48% @ 130 Watts Output Power
- Internally Matched, Controlled Q, for Ease of Use
- High Gain, High Efficiency and High Linearity
- Integrated ESD Protection
- Designed for Maximum Gain and Insertion Phase Flatness
- Capable of Handling 5:1 VSWR, @ 28 Vdc, All Frequency Band, 130 Watts CW Output Power
- Excellent Thermal Stability
- Characterized with Series Equivalent Large-Signal Impedance Parameters
- Low Gold Plating Thickness on Leads, 40μ" Nominal.
- In Tape and Reel. R3 Suffix = 250 Units per 56 mm, 13 inch Reel.

GSM/GSM EDGE
921 - 960 MHz, 130 W, 28 V
LATERAL N-CHANNEL
RF POWER MOSFETs

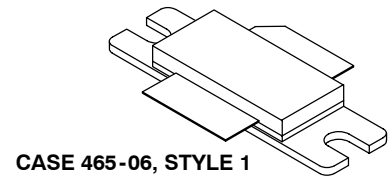

CASE 465-06, STYLE 1
NI-780
MRF9130LR3

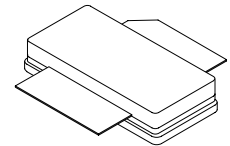

CASE 465A-06, STYLE 1
NI-780S
MRF9130LSR3

MAXIMUM RATINGS

Rating	Symbol	Value	Unit
Drain-Source Voltage	V _{DSS}	65	Vdc
Gate-Source Voltage	V _{GS}	- 0.5, +15	Vdc
Total Device Dissipation @ T _C = 25°C Derate above 25°C	P _D	298 1.7	Watts W/°C
Storage Temperature Range	T _{stg}	- 65 to +200	°C
Operating Junction Temperature	T _J	200	°C

THERMAL CHARACTERISTICS

Characteristic	Symbol	Value	Unit
Thermal Resistance, Junction to Case	R _{θJC}	0.6	°C/W

ESD PROTECTION CHARACTERISTICS

Test Conditions	Class
Human Body Model	1 (Minimum)
Machine Model	M2 (Minimum)
Charge Device Model	C7 (Minimum)

NOTE - CAUTION - MOS devices are susceptible to damage from electrostatic charge. Reasonable precautions in handling and packaging MOS devices should be observed.

Freescale Semiconductor, Inc.

www.DataSheet4U.com

Freescale Semiconductor, Inc.

ELECTRICAL CHARACTERISTICS (T_C = 25°C unless otherwise noted)

Characteristic	Symbol	Min	Typ	Max	Unit
----------------	--------	-----	-----	-----	------

OFF CHARACTERISTICS

Zero Gate Voltage Drain Leakage Current (V _{DS} = 65 Vdc, V _{GS} = 0 Vdc)	I _{DSS}	—	—	10	μAdc
Zero Gate Voltage Drain Leakage Current (V _{DS} = 28 Vdc, V _{GS} = 0 Vdc)	I _{DSS}	—	—	1	μAdc
Gate-Source Leakage Current (V _{GS} = 5 Vdc, V _{DS} = 0 Vdc)	I _{GSS}	—	—	1	μAdc

ON CHARACTERISTICS

Gate Threshold Voltage (V _{DS} = 10 Vdc, I _D = 450 μAdc)	V _{GS(th)}	2	3	4	Vdc
Gate Quiescent Voltage (V _{DS} = 28 Vdc, I _D = 1000 mAdc)	V _{GS(Q)}	—	3.6	—	Vdc
Drain-Source On-Voltage (V _{GS} = 10 Vdc, I _D = 3 Adc)	V _{DS(on)}	—	0.2	0.4	Vdc
Forward Transconductance (V _{DS} = 10 Vdc, I _D = 9 Adc)	g _{fs}	—	12	—	S

DYNAMIC CHARACTERISTICS (1)

Output Capacitance (V _{DS} = 28 Vdc ± 30 mV(rms)ac @ 1 MHz, V _{GS} = 0 Vdc)	C _{oss}	—	110	—	pF
Reverse Transfer Capacitance (V _{DS} = 28 Vdc ± 30 mV(rms)ac @ 1 MHz, V _{GS} = 0 Vdc)	C _{rss}	—	4.4	—	pF

FUNCTIONAL TESTS (In Motorola Test Fixture)

Power Output, 1 dB Compression Point (V _{DD} = 28 Vdc, I _{DQ} = 1000 mA, f = 921 and 960 MHz)	P _{1dB}	120	135	—	W
Common-Source Amplifier Power Gain (V _{DD} = 28 Vdc, P _{out} = 130 W, I _{DQ} = 1000 mA, f = 921 and 960 MHz)	G _{ps}	15.5	16.5	—	dB
Drain Efficiency (V _{DD} = 28 Vdc, P _{out} = 130 W, I _{DQ} = 1000 mA, f = 921 and 960 MHz)	η	43	48	—	%
Input Return Loss (V _{DD} = 28 Vdc, P _{out} = 130 W, I _{DQ} = 1000 mA, f = 921 and 960 MHz)	IRL	—	-12	-9	dB
Output Mismatch Stress (V _{DD} = 28 Vdc, P _{out} = 130 W CW, I _{DQ} = 1000 mA, f = 921 MHz, VSWR = 5:1, All Phase Angles at Frequency of Tests)	Ψ	No Degradation In Output Power Before and After Test			

(1) Part is internally input matched.

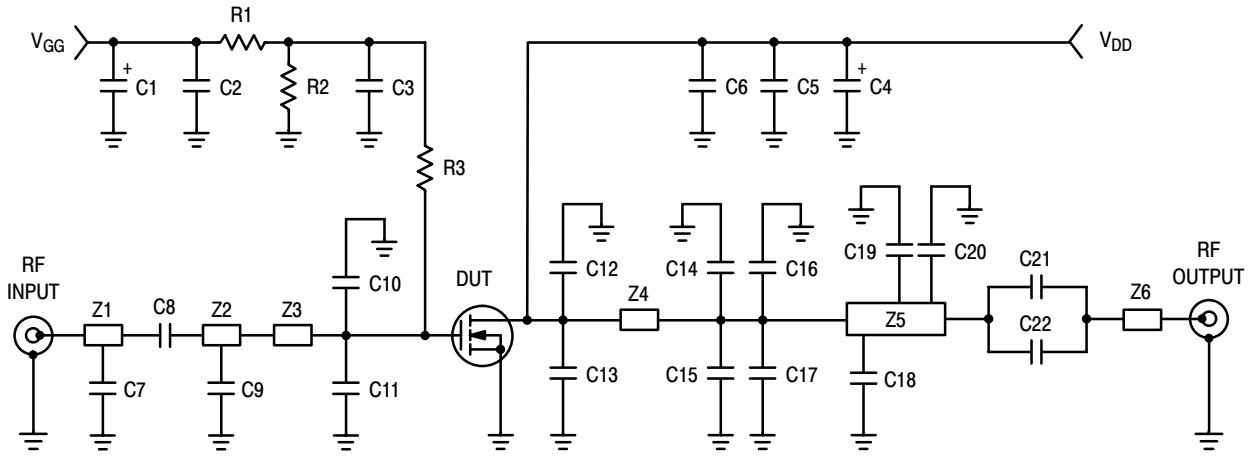

Figure 1. 921-960 MHz Test Circuit Schematic

www.DataSheet4U.com

Table 1. 921-960 MHz Test Circuit Component Designations and Values

Designators	Description
C1, C4	10 μ F, 35 V Tantalum Capacitors, Vishay - Sprague #293D106X9035D
C2, C5	100 nF Chip Capacitors (1206), AVX #1206C104KATDA
C3, C8, C21, C22	22 pF, 100B Chip Capacitors, ATC #100B220C
C6	33 pF, 100B Chip Capacitor, ATC #100B330JW
C7	1.0 pF, 100B Chip Capacitor, ATC #100B1R0BW
C9	4.7 pF, 100B Chip Capacitor, ATC #100B4R7BW
C10	8.2 pF, 100B Chip Capacitor, ATC #100B8R2CW
C11	10 pF, 100B Chip Capacitor, ATC #100B100GW
C12, C13	12 pF, 100B Chip Capacitors, ATC #100B120GW
C14, C15	2.7 pF, 100B Chip Capacitors, ATC #100B2R7BW
C16, C17, C18	3.9 pF, 100B Chip Capacitors, ATC #100B3R9BW
C19	3.3 pF, 100B Chip Capacitor, ATC #100B3R3BW
C20	1.8 pF, 100B Chip Capacitor, ATC #100B1R8BW
R1	18 k Ω , 1/8 W Chip Resistor (1206)
R2	10 k Ω , 1/8 W Chip Resistor (1206)
R3	1.0 k Ω , 1/8 W Chip Resistor (1206)
Z1	0.117" x 0.600" Microstrip
Z2	0.117" x 1.851" Microstrip
Z3	1.074" x 1.068" Microstrip
Z4	1.074" x 0.980" Microstrip
Z5	0.117" x 1.933" Microstrip
Z6	0.117" x 0.605" Microstrip
PCB	Taconic TLX8, 0.030", $\epsilon_r = 2.55$

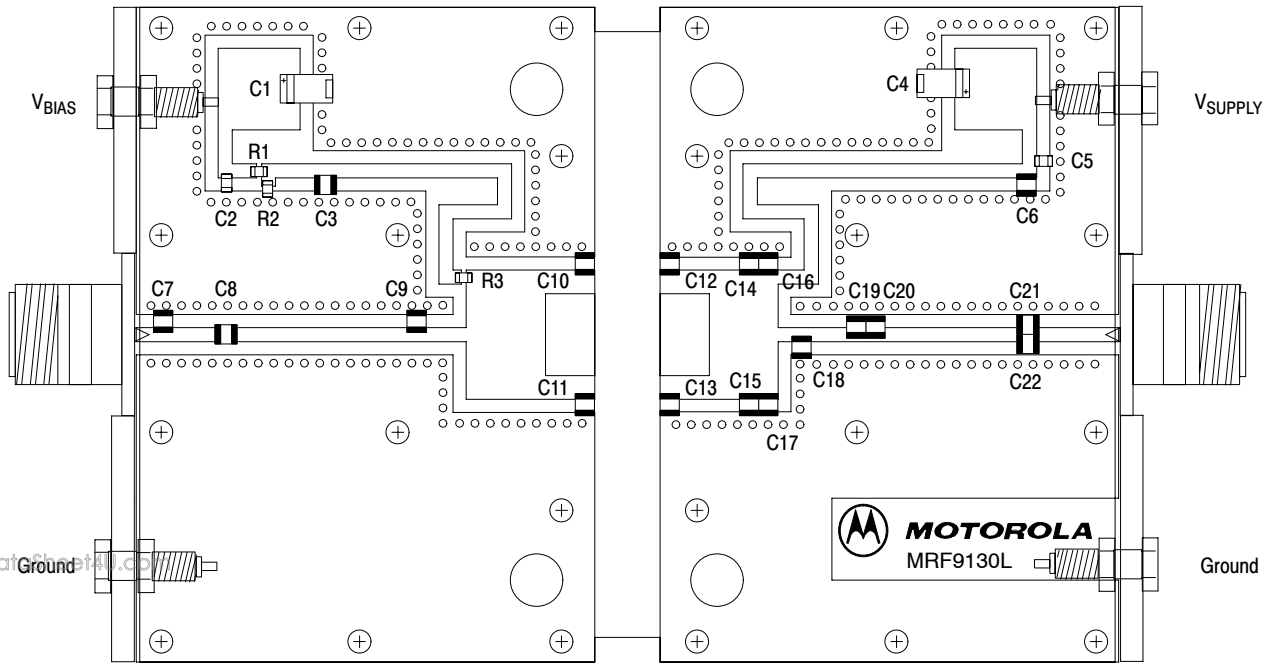

Figure 2. 921-960 MHz Test Circuit Component Layout

Freescale Semiconductor, Inc.

www.DataSheet4U.com

TYPICAL CHARACTERISTICS

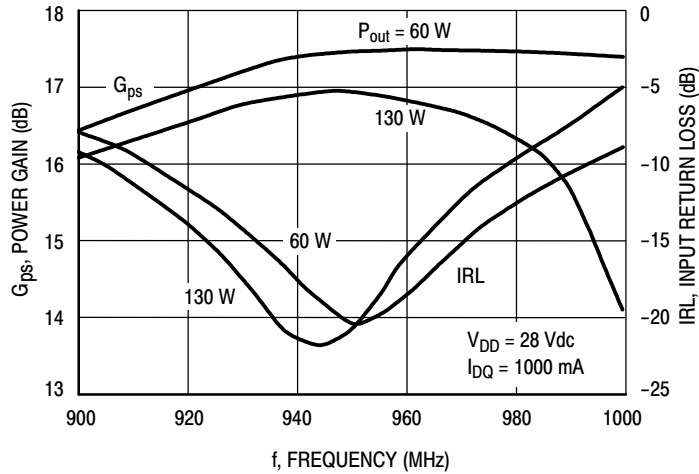

Figure 3. Power Gain and Input Return Loss versus Frequency

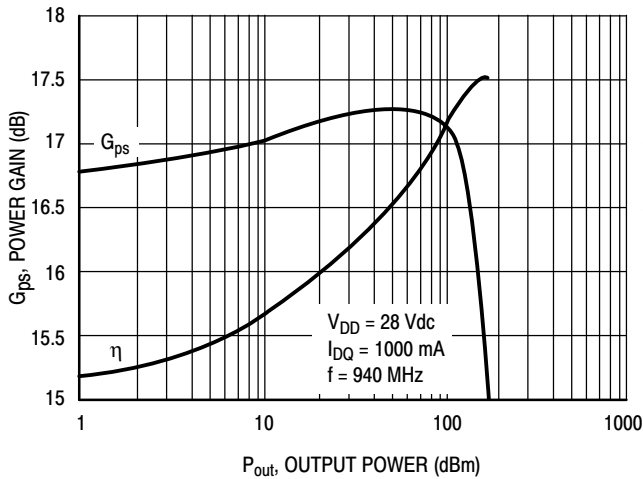

Figure 4. Power Gain and Efficiency versus Output Power

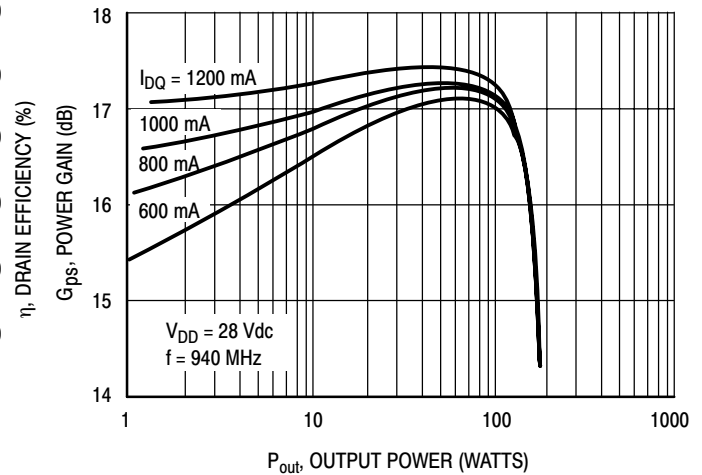

Figure 5. Power Gain versus Output Power

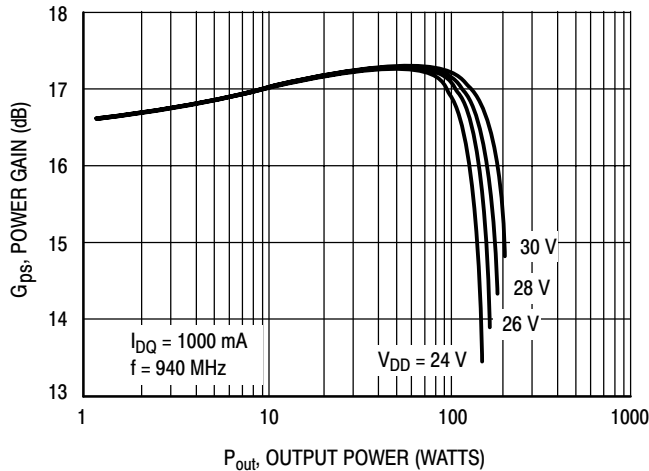

Figure 6. Power Gain versus Output Power

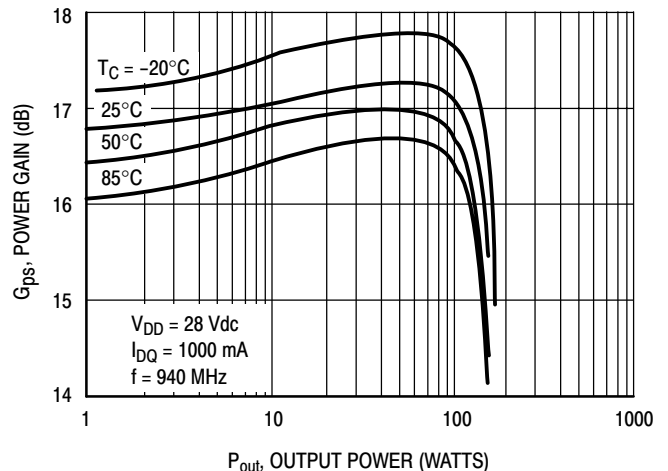

Figure 7. Power Gain versus Output Power

Freescale Semiconductor, Inc.

TYPICAL CHARACTERISTICS

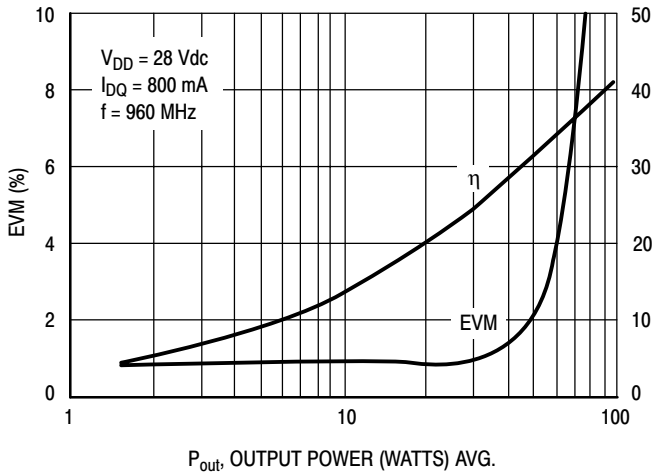

Figure 8. EVM and Efficiency versus Output Power

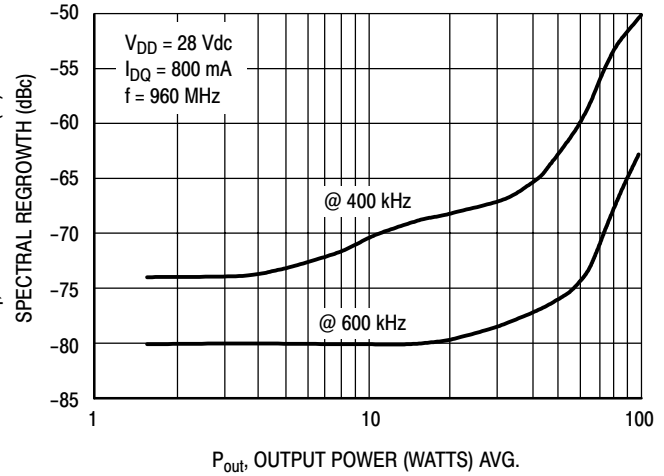
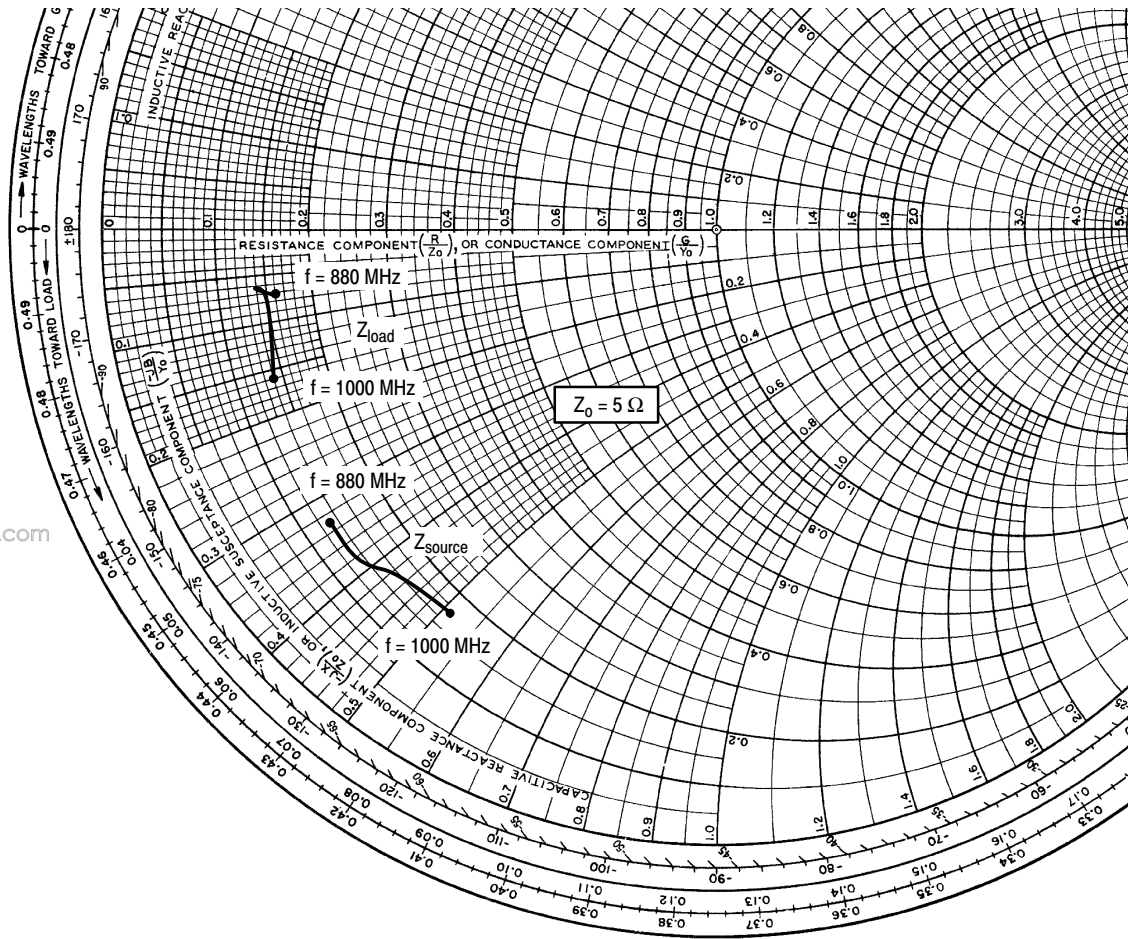

Figure 9. Spectral Regrowth versus Output Power

NOTE: Curves on Figure 8 and 9 gathered on a GSM EDGE optimized text fixture.

Freescale Semiconductor, Inc.

www.DataSheet4U.com



$V_{DD} = 28 \text{ Vdc}$, $I_{DQ} = 1000 \text{ mA}$, $P_{out} = 130 \text{ W CW}$

f MHz	Z_{source} Ω	Z_{load} Ω
880	$0.63 - j1.66$	$0.82 - j0.36$
920	$0.67 - j1.88$	$0.72 - j0.30$
960	$0.82 - j2.18$	$0.74 - j0.37$
1000	$0.86 - j2.56$	$0.69 - j0.79$

Z_{source} = Test circuit impedance as measured from gate to ground.

Z_{load} = Test circuit impedance as measured from drain to ground.

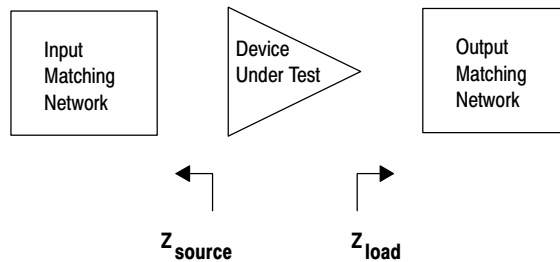

Figure 10. Series Equivalent Input and Output Impedance

NOTES

Freescale Semiconductor, Inc.

www.DataSheet4U.com

NOTES

Freescale Semiconductor, Inc.

www.DataSheet4U.com

NOTES

Freescale Semiconductor, Inc.

www.DataSheet4U.com

Freescale Semiconductor, Inc.

PACKAGE DIMENSIONS

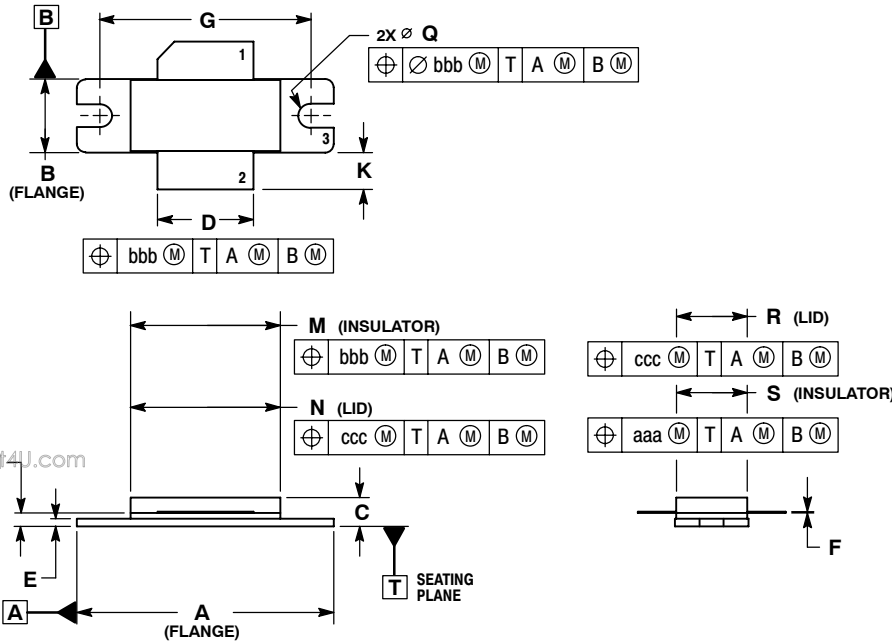

NOTES:

1. DIMENSIONING AND TOLERANCING PER ANSI Y14.5M-1994.
2. CONTROLLING DIMENSION: INCH.
3. DELETED
4. DIMENSION H IS MEASURED 0.030 (0.762) AWAY FROM PACKAGE BODY.

DIM	INCHES		MILLIMETERS	
	MIN	MAX	MIN	MAX
A	1.335	1.345	33.91	34.16
B	0.380	0.390	9.65	9.91
C	0.125	0.170	3.18	4.32
D	0.495	0.505	12.57	12.83
E	0.035	0.045	0.89	1.14
F	0.003	0.006	0.08	0.15
G	1.100 BSC		27.94 BSC	
H	0.057	0.067	1.45	1.70
K	0.170	0.210	4.32	5.33
M	0.774	0.786	19.66	19.96
N	0.772	0.788	19.60	20.00
Q	Ø.118	Ø.138	Ø3.00	Ø3.51
R	0.365	0.375	9.27	9.53
S	0.365	0.375	9.27	9.52
aaa	0.005 REF		0.127 REF	
bbb	0.010 REF		0.254 REF	
ccc	0.015 REF		0.381 REF	

STYLE 1:

- PIN 1. DRAIN
- PIN 2. GATE
- PIN 3. SOURCE

CASE 465-06
ISSUE F
NI-780
MRF9130LR3

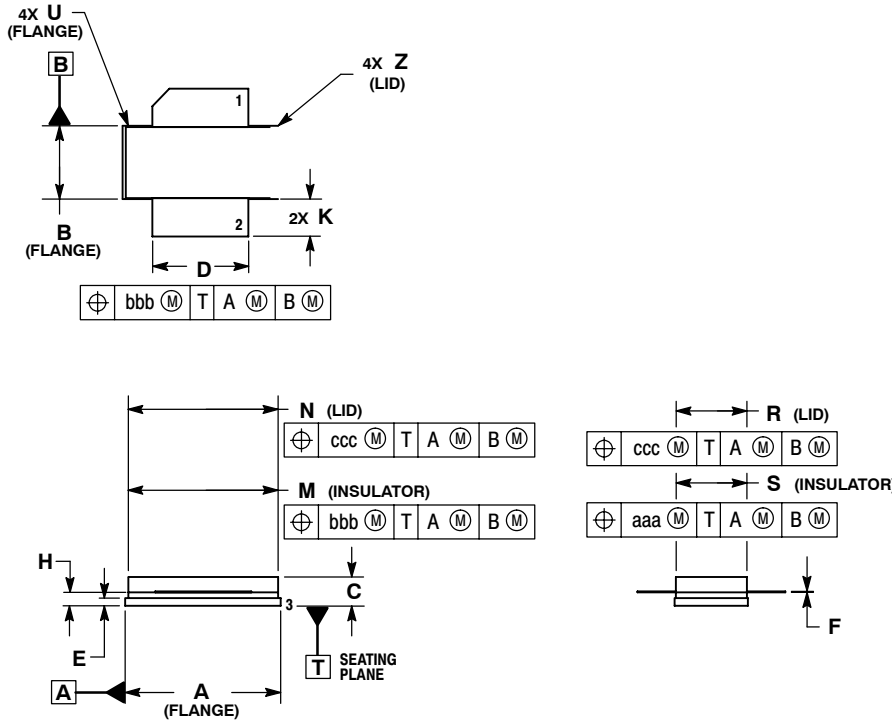

NOTES:

1. DIMENSIONING AND TOLERANCING PER ANSI Y14.5M-1994.
2. CONTROLLING DIMENSION: INCH.
3. DELETED
4. DIMENSION H IS MEASURED 0.030 (0.762) AWAY FROM PACKAGE BODY.

DIM	INCHES		MILLIMETERS	
	MIN	MAX	MIN	MAX
A	0.805	0.815	20.45	20.70
B	0.380	0.390	9.65	9.91
C	0.125	0.170	3.18	4.32
D	0.495	0.505	12.57	12.83
E	0.035	0.045	0.89	1.14
F	0.003	0.006	0.08	0.15
H	0.057	0.067	1.45	1.70
K	0.170	0.210	4.32	5.33
M	0.774	0.786	19.61	20.02
N	0.772	0.788	19.61	20.02
R	0.365	0.375	9.27	9.53
S	0.365	0.375	9.27	9.52
U	---	0.040	---	1.02
Z	---	0.030	---	0.76
aaa	0.005 REF		0.127 REF	
bbb	0.010 REF		0.254 REF	
ccc	0.015 REF		0.381 REF	

STYLE 1:

- PIN 1. DRAIN
- PIN 2. GATE
- PIN 5. SOURCE

CASE 465A-06
ISSUE F
NI-780S
MRF9130LSR3

www.DataSheets4U.com
Freescale Semiconductor, Inc.

Information in this document is provided solely to enable system and software implementers to use Motorola products. There are no express or implied copyright licenses granted hereunder to design or fabricate any integrated circuits or integrated circuits based on the information in this document.

Motorola reserves the right to make changes without further notice to any products herein. Motorola makes no warranty, representation or guarantee regarding the suitability of its products for any particular purpose, nor does Motorola assume any liability arising out of the application or use of any product or circuit, and specifically disclaims any and all liability, including without limitation consequential or incidental damages. "Typical" parameters that may be provided in Motorola data sheets and/or specifications can and do vary in different applications and actual performance may vary over time. All operating parameters, including "Typicals", must be validated for each customer application by customer's technical experts. Motorola does not convey any license under its patent rights nor the rights of others. Motorola products are not designed, intended, or authorized for use as components in systems intended for surgical implant into the body, or other applications intended to support or sustain life, or for any other application in which the failure of the Motorola product could create a situation where personal injury or death may occur. Should Buyer purchase or use Motorola products for any such unintended or unauthorized application, Buyer shall indemnify and hold Motorola and its officers, employees, subsidiaries, affiliates, and distributors harmless against all claims, costs, damages, and expenses, and reasonable attorney fees arising out of, directly or indirectly, any claim of personal injury or death associated with such unintended or unauthorized use, even if such claim alleges that Motorola was negligent regarding the design or manufacture of the part.

MOTOROLA and the Stylized M Logo are registered in the US Patent and Trademark Office. All other product or service names are the property of their respective owners. Motorola, Inc. is an Equal Opportunity/Affirmative Action Employer.

© Motorola Inc. 2004

HOW TO REACH US:

USA/EUROPE/LOCATIONS NOT LISTED:
Motorola Literature Distribution
P.O. Box 5405, Denver, Colorado 80217
1-800-521-6274 or 480-768-2130

JAPAN: Motorola Japan Ltd.; SPS, Technical Information Center,
3-20-1, Minami-Azabu, Minato-ku, Tokyo 106-8573, Japan
81-3-3440-3569

ASIA/PACIFIC: Motorola Semiconductors H.K. Ltd.; Silicon Harbour Centre,
2 Dai King Street, Tai Po Industrial Estate, Tai Po, N.T., Hong Kong
852-26668334

HOME PAGE: <http://motorola.com/semiconductors>



◇ **For More Information On This Product,
Go to: www.freescale.com**