



MS619ST/MX620ST/MW621ST

Digital Projector

User Manual



# Table of contents

<b>Important safety instructions</b> .....	<b>3</b>
<b>Introduction</b> .....	<b>7</b>
Projector features .....	7
Shipping contents .....	8
Projector exterior view .....	9
Controls and functions .....	10
<b>Positioning your projector</b> .....	<b>13</b>
Choosing a location .....	13
Obtaining a preferred projected image size .....	14
<b>Connection</b> .....	<b>16</b>
Connecting video source devices .....	17
<b>Operation</b> .....	<b>18</b>
Starting up the projector .....	18
Adjusting the projected image .....	19
Using the menus .....	21
Securing the projector .....	22
Switching input signal .....	24
Magnifying and searching for details .....	25
Selecting the aspect ratio .....	26
Optimizing the image .....	28
Setting the presentation timer .....	31
Remote paging operations .....	32
Freezing the image .....	32
Hiding the image .....	33
Locking control keys .....	33
Operating in a high altitude environment .....	33
Adjusting the sound .....	34
Using the test pattern .....	34

Using the teaching templates .....	35
Presenting from a USB Reader .....	36
Shutting down the projector .....	37
Direct power off .....	37
Menu operation .....	38
<b>Maintenance</b> .....	<b>48</b>
Care of the projector .....	48
Lamp information .....	49
<b>Troubleshooting</b> .....	<b>55</b>
<b>Specifications</b> .....	<b>56</b>
Projector specifications .....	56
Dimensions .....	57
Ceiling mount installation .....	57
Timing chart .....	58
<b>Warranty and Copyright information</b> .....	<b>62</b>

# Important safety instructions

Your projector is designed and tested to meet the latest standards for safety of information technology equipment. However, to ensure safe use of this product, it is important that you follow the instructions mentioned in this manual and marked on the product.

## Safety Instructions

1. **Please read this manual before you operate your projector.** Save it for future reference.

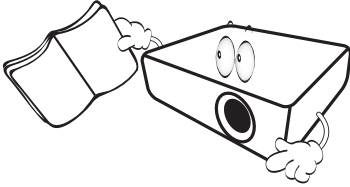

2. **Do not look straight at the projector lens during operation.** The intense light beam may damage your eyes.

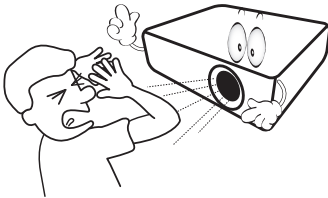

3. **Refer servicing to qualified service personnel.**

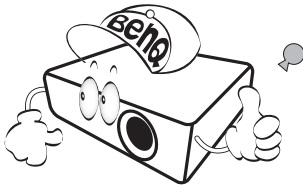

4. **Always open the lens shutter (if any) or remove the lens cap (if any) when the projector lamp is on.**

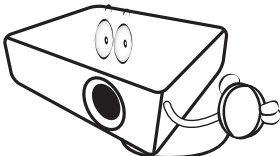

5. In some countries, the line voltage is NOT stable. This projector is designed to operate safely within a mains voltage between 100 to 240 volts AC, but could fail if power cuts or surges of  $\pm 10$  volts occur. **In areas where the mains voltage may fluctuate or cut out, it is recommended that you connect your projector through a power stabilizer, surge protector or uninterruptible power supply (UPS).**

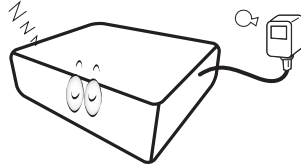

6. Do not block the projection lens with any objects when the projector is under operation as this could cause the objects to become heated and deformed or even cause a fire. To temporarily turn off the lamp, press **ECO BLANK** on the projector or remote control.

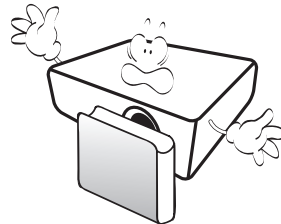

## Safety Instructions (Continued)

7. The lamp becomes extremely hot during operation. Allow the projector to cool for approximately 45 minutes prior to removing the lamp assembly for replacement.

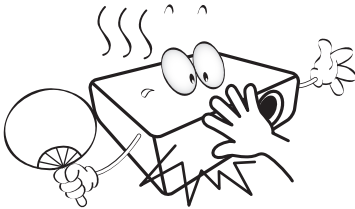

8. Do not operate lamps beyond the rated lamp life. Excessive operation of lamps beyond the rated life could cause them to break on rare occasions.

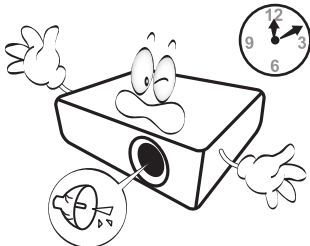

9. Never replace the lamp assembly or any electronic components unless the projector is unplugged.

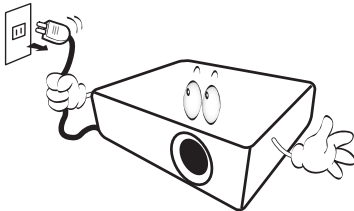

10. Do not place this product on an unstable cart, stand, or table. The product may fall, sustaining serious damage.

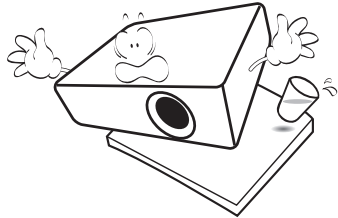

11. Do not attempt to disassemble this projector. There are dangerous high voltages inside which may cause death if you should come into contact with live parts. The only user serviceable part is the lamp which has its own removable cover.

Under no circumstances should you ever undo or remove any other covers. Refer servicing only to suitably qualified professional service personnel.

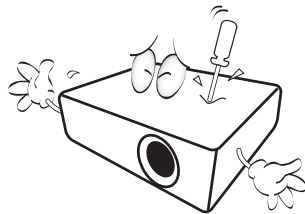

12. When the projector is under operation, you may sense some heated air and odor from its ventilation grill. It is a normal phenomenon and not a product defect.

## Safety Instructions (Continued)

13. Do not place this projector in any of the following environments.
- Space that is poorly ventilated or confined. Allow at least 50 cm clearance from walls and free flow of air around the projector.
  - Locations where temperatures may become excessively high, such as the inside of a car with all windows rolled up.
  - Locations where excessive humidity, dust, or cigarette smoke may contaminate optical components, shorten the projector's life span and darken the image.

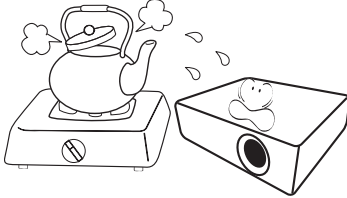

- Locations near fire alarms
- Locations with an ambient temperature above 40°C / 104°F
- Locations where the altitudes are higher than 3000 m (10000 feet).

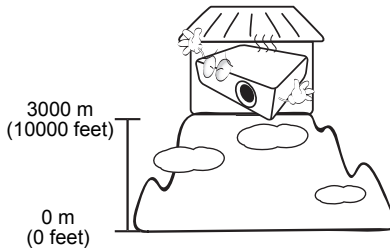

14. Do not block the ventilation holes.
- Do not place this projector on a blanket, bedding or any other soft surface.
  - Do not cover this projector with a cloth or any other item.
  - Do not place inflammables near the projector.

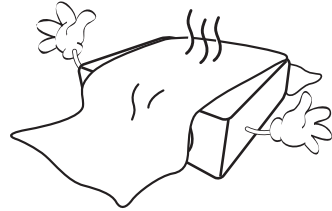

If the ventilation holes are seriously obstructed, overheating inside the projector may result in a fire.

15. Always place the projector on a level, horizontal surface during operation.
- Do not use if tilted at an angle of more than 10 degrees left to right, nor at angle of more than 15 degrees front to back. Using the projector when it is not fully horizontal may cause a malfunction of, or damage to, the lamp.

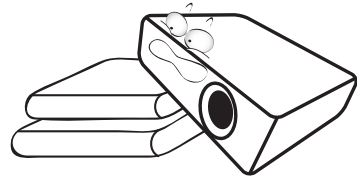

16. Do not stand the projector on end vertically. Doing so may cause the projector to fall over, causing injury or resulting in damage to the projector.

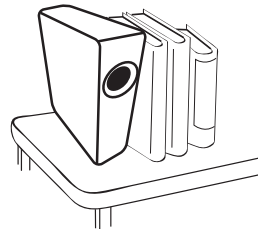

## Safety Instructions (Continued)

17. Do not step on the projector or place any objects upon it. Besides probable physical damage to the projector, doing so may result in accidents and possible injury.

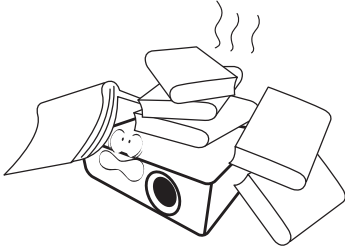

18. Do not place liquids near or on the projector. Liquids spilled into the projector may cause it to fail. If the projector does become wet, disconnect it from the power supply's power outlet and call BenQ to have the projector serviced.

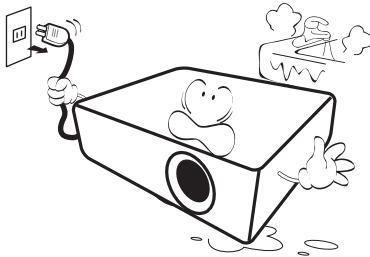

19. This product is capable of displaying inverted images for ceiling mount installation.



Use only BenQ's Ceiling Mount Kit for mounting the projector and ensure it is securely installed.

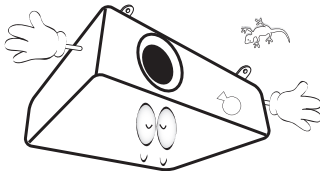

20. This apparatus must be earthed.



### Ceiling mounting the projector

We want you to have a pleasant experience using your BenQ projector, so we need to bring this safety matter to your attention to prevent possible damage to person and property.

If you intend to mount your projector on the ceiling, we strongly recommend that you use a proper fitting BenQ projector ceiling mount kit and that you ensure it is securely and safely installed.

If you use a non-BenQ brand projector ceiling mount kit, there is a safety risk that the projector may fall from the ceiling due to an improper attachment through the use of the wrong gauge or length screws.

You can purchase a BenQ projector ceiling mount kit from the place you purchased your BenQ projector. BenQ recommends that you also purchase a separate Kensington lock compatible security cable and attach it securely to both the Kensington lock slot on the projector and the base of the ceiling mount bracket. This will perform the secondary role of restraining the projector should its attachment to the mounting bracket become loose.



Hg - Lamp contains mercury. Manage in accordance with local disposal laws. See [www.lamprecycle.org](http://www.lamprecycle.org).

# Introduction

## Projector features

### The projector offers the following features

- **SmartEco™ starts your dynamic power saving**  
The SmartEco™ technology offers a new way of operating the projector lamp system and saves lamp power depending on the content brightness level.
  - **Longest lamp life with SmartEco™ technology**  
The SmartEco™ technology lowers the power consumption and increases the lamp life.
  - **ECO BLANK saves the lamp power**  
Pressing the **ECO BLANK** button to hide the image and immediately lower the lamp power at the same time.
  - **Less than 0.5W in standby condition**  
Less than 0.5W power consumption under standby mode.
  - **Filter Free**  
Filter free design to lower maintenance and operating costs.
  - **Network Control**  
Wireless network control allowing management of projector status from a computer using a web browser.
  - **One-key auto-adjustment**  
Pressing **AUTO** on the keypad or remote control to show the best picture quality immediately.
  - **Built-in 10W speaker(s)**  
Built-in 10W speaker(s) providing mixed mono audio when an audio input is connected
  - **Quick Cooling, Auto Power Off, Direct Power On**  
**Quick Cooling** function speeds up the cooling process when turning off the projector. **Auto Power Off** function allows the projector to turn off automatically if no input signal is detected after a set period of time. **Direct Power On** boots up the projector automatically when the power is connected.
  - **3D Function supported**  
Various 3D formats make the 3D function more flexible. By presenting the depth of the images, you can wear BenQ 3D glasses to enjoy the 3D movies, videos and sporting events in a more realistic way.
-  • The apparent brightness of the projected image will vary depending on the ambient lighting conditions, selected input signal contrast/brightness settings, and is directly proportional to projection distance.
- The lamp brightness will decline over time and may vary within the lamp manufacturers specifications. This is normal and expected behavior.

# Shipping contents

Carefully unpack and verify that you have all of the items shown below. If any of these items are missing, please contact your place of purchase.

## Standard accessories

 The supplied accessories will be suitable for your region, and may differ from those illustrated.

\*The warranty card is only supplied in some specific regions. Please consult your dealer for detailed information.

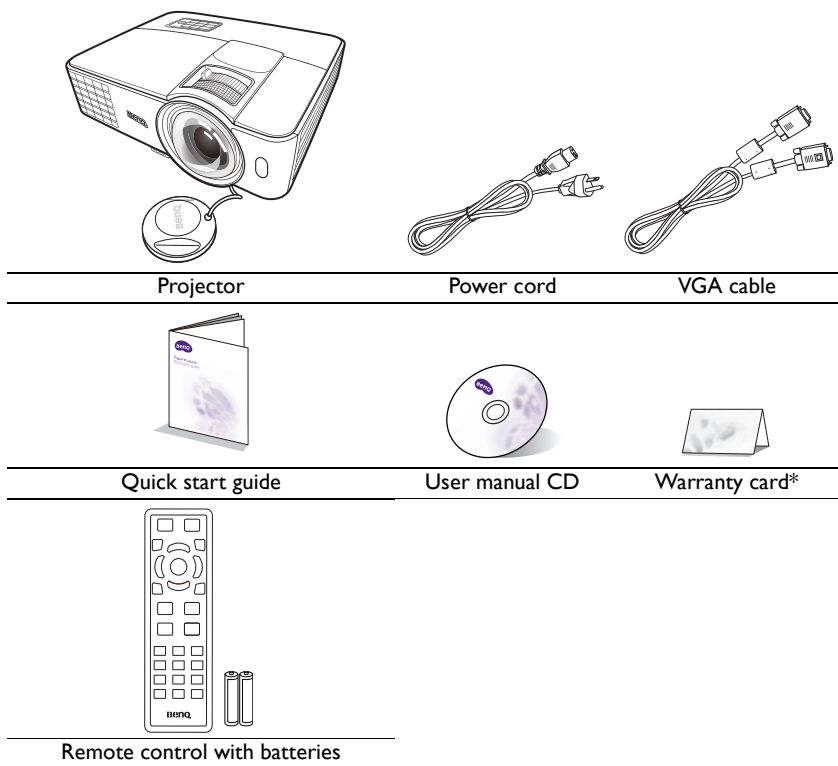

## Optional accessories

1. Spare lamp kit
2. Ceiling mount kit
3. RS232 cable
4. Carry bag



# Projector exterior view

## Front/upper side

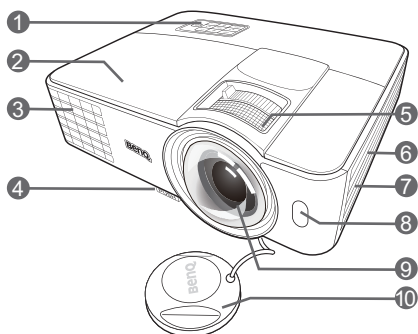

## Rear/lower side

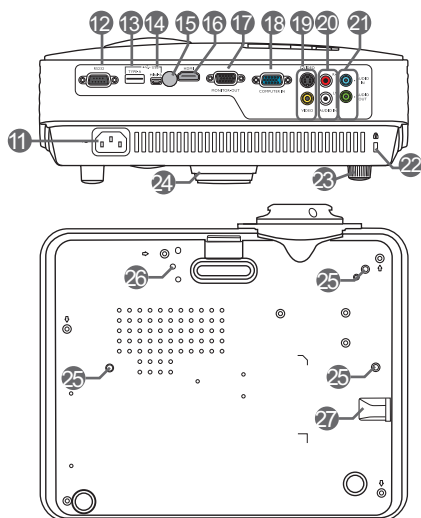

1. External control panel  
(See "[Controls and functions](#)" on page 10 for details.)
2. Lamp cover
3. Vent (heated air exhaust)
4. Quick-release button
5. Focus and Zoom ring
6. Vent (cool air intake)
7. Speaker grill
8. Front IR remote sensor
9. Projection lens
10. Lens cap
11. AC power jack
12. RS232 control port
13. USB Type-A port
14. USB Mini-B port
15. Rear IR remote sensor
16. HDMI-input port
17. RGB signal output jack
18. RGB (PC)/Component Video (YPbPr/ YCbCr) signal input jack
19. S-Video input jack
20. Video input jack
21. Audio (L/R) input jacks
22. Kensington anti-theft lock slot
23. Rear adjuster foot
24. Front adjuster foot
25. Ceiling mount holes
26. PointWrite module mounting hole
27. Security bar

# Controls and functions

## Projector

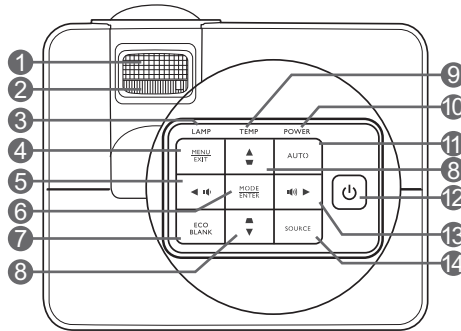

- 1. Focus ring**  
Adjusts the focus of the projected image.
- 2. Zoom ring**  
Adjusts the size of the image.
- 3. LAMP indicator light**  
Indicates the status of the lamp. Lights up or flashes when the lamp has developed a problem.
- 4. MENU/EXIT**  
Turns on the On-Screen Display (OSD) menu. Goes back to previous OSD menu, exits and saves menu settings.
- 5. ◀ Left/ 🔊**  
Decreases the projector volume.
- 6. MODE/ENTER**  
Selects an available picture setup mode. Activates the selected On-Screen Display (OSD) menu item.
- 7. ECO BLANK**  
Used to hide the screen picture.
- 8. Keystone/Arrow keys ( ◻ / ▲ Up, ◻ / ▼ Down)**  
Manually corrects distorted images resulting from an angled projection.
- 9. TEMPerature warning light**  
Lights up red if the projector's temperature becomes too high.
- 10. POWER indicator light**  
Lights up or flashes when the projector is under operation.
- 11. AUTO**  
Automatically determines the best picture timings for the displayed image.
- 12. 🔌 POWER**  
Toggles the projector between standby mode and on.
- 13. ▶ Right/ 🔊**  
Increases the projector volume. When the On-Screen Display (OSD) menu is activated, the #5, #8, and #13 keys are used as directional arrows to select the desired menu items and to make adjustments.
- 14. SOURCE**  
Displays the source selection bar.

# Remote control

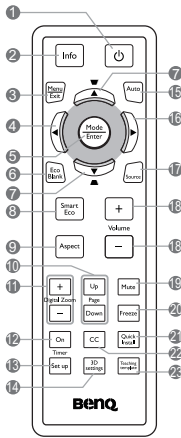

**1. POWER**

Toggles the projector between standby mode and on.

**2. Info**

Shows the status information of the projector.

**3. MENU/EXIT**

Turns on the On-Screen Display (OSD) menu. Goes back to previous OSD menu, exits and saves menu settings.

**4. Left**

**5. MODE/ENTER**

Selects an available picture setup mode. Activates the selected On-Screen Display (OSD) menu item.

**6. ECO BLANK**

Used to hide the screen picture.

**7. Keystone/Arrow keys ( ▽ / ▲ Up, ▢ / ▼ Down)**

Manually corrects distorted images resulting from an angled projection.

**8. SmartEco**

Displays the lamp mode selection bar.

**9. Aspect**

Selects the display aspect ratio.

**10. Page Up/Page Down**

Operate your display software program (on a connected PC) which responds to page up/down commands (like Microsoft PowerPoint).

**11. Digital Zoom (+, -)**

Magnifies or reduces the projected picture size.

**12. Timer On**

Activates or displays an on-screen timer based on your own timer setting.

**13. Timer Set up**

Enters presentation timer setting directly.

**14. 3D settings**

Enters 3D settings directly.

**15. AUTO**

Automatically determines the best picture timings for the displayed image.

**16. Right**

When the On-Screen Display (OSD) menu is activated, the #4, #7, and #16 keys are used as directional arrows to select the desired menu items and to make adjustments.

**17. SOURCE**

Displays the source selection bar.

**18. Volume +/-**

Adjusts the sound level.

**19. Mute**

Toggles projector audio between on and off.

**20. Freeze**

Freezes the projected image.

**21. Quick Install**

Quickly selects several functions to adjust the projected image and displays the test pattern.

**22. CC**

Displays the video term description on screen which is provided for hard-of-hearing viewers.

**23. Teaching template**

Enters **Teaching template** setting directly.

## Remote control effective range

The remote control must be held at an angle within 30 degrees perpendicular to the projector's IR remote control sensor(s) to function correctly. The distance between the remote control and the sensor(s) should not exceed 8 meters (~ 26 feet).

Make sure that there are no obstacles between the remote control and the IR sensor(s) on the projector that might obstruct the infra-red beam.

- Operating the projector from the front
- Operating the projector from the rear

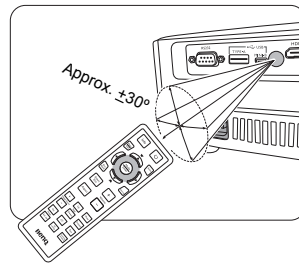
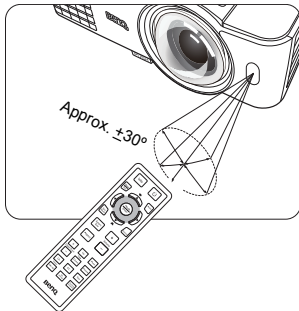

## Replacing the remote control batteries

1. Open the battery cover as illustrated.
2. Remove any existing batteries (if necessary) and install two AAA batteries observing the battery polarities as indicated in the base of the battery compartment. Positive (+) goes to positive and negative (-) goes to negative.
3. Refit the cover by aligning it with the base and snapping it back down into position.

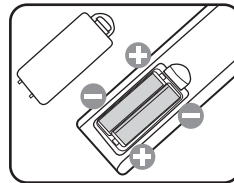
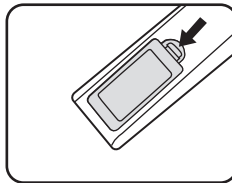

- Avoid leaving the remote control and batteries in an excessive heat or humid environment like the kitchen, bathroom, sauna, sunroom or in a closed car.
- Replace only with the same or equivalent type recommended by the battery manufacturer.
- Dispose of the used batteries according to the manufacturer's instructions and local environment regulations for your region.
- Never throw the batteries into a fire. There may be danger of an explosion.
- If the batteries are dead or if you will not be using the remote control for an extended period of time, remove the batteries to avoid damage to the remote control from possible battery leakage.

# Positioning your projector

## Choosing a location

Your projector is designed to be installed in one of four possible installation locations:

---

### 1. Front Table

Select this location with the projector placed on the table in front of the screen. This is the most common way to position the projector for quick setup and portability.

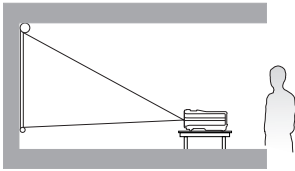

### 2. Front Ceiling

Select this location with the projector suspended upside-down from the ceiling in front of the screen.

Purchase the BenQ Projector Ceiling Mount Kit from your dealer to mount your projector on the ceiling.

Set **Front Ceiling** in the **SYSTEM SETUP: Basic > Projector Installation** menu after you turn the projector on.

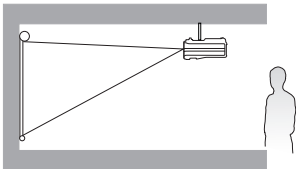

### 3. Rear Ceiling

Select this location with the projector suspended upside-down from the ceiling behind the screen.

Note that a special rear projection screen and the BenQ Projector Ceiling Mount Kit are required for this installation location.

Set **Rear Ceiling** in the **SYSTEM SETUP: Basic > Projector Installation** menu after you turn the projector on.

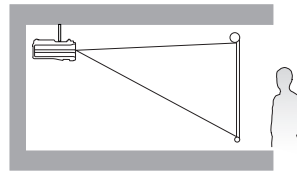

### 4. Rear Table

Select this location with the projector placed on the table behind the screen.

Note that a special rear projection screen is required.

Set **Rear Table** in the **SYSTEM SETUP: Basic > Projector Installation** menu after you turn the projector on.

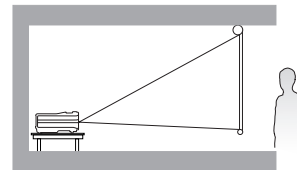

---

Your room layout or personal preference will dictate which installation location you select. Take into consideration the size and position of your screen, the location of a suitable power outlet, as well as the location and distance between the projector and the rest of your equipment.

# Obtaining a preferred projected image size

The distance from the projector lens to the screen, the zoom setting, and the video format each factors in the projected image size.

## Projection dimensions

Refer to ["Dimensions" on page 57](#) for the center of lens dimensions of this projector before calculating the appropriate position.

### MS619ST/MX620ST

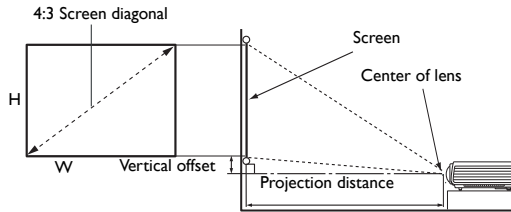

The screen aspect ratio is 4:3 and the projected picture is 4:3

Screen size				Distance from screen (mm)			Vertical offset (mm)
Diagonal		W (mm)	H (mm)	Min length	Average	Max length	
Inch	mm			(max. zoom)		(min. zoom)	
40	1016	813	610	734	807	881	30
50	1270	1016	762	917	1009	1101	38
60	1524	1219	914	1101	1211	1321	46
80	2032	1626	1219	1468	1615	1761	61
100	2540	2032	1524	1835	2018	2202	76
120	3048	2438	1829	2202	2422	2642	91
150	3810	3048	2286	2752	3028	3303	114
200	5080	4064	3048	3670	4037	4404	152
220	5588	4470	3353	4037	4440	4844	168
250	6350	5080	3810	4587	5046	5505	191
300	7620	6096	4572	5505	6055	6606	229

For example, if you are using an 120-inch screen, the recommended projection distance is 2422 mm and the vertical offset is 91 mm.

If your measured projection distance is 3.0 m (3000 mm), the closest match in the ["Distance from screen \(mm\)"](#) column is 3028 mm. Looking across this row shows that a 150" (about 3.8 m) screen is required.

# MW621ST

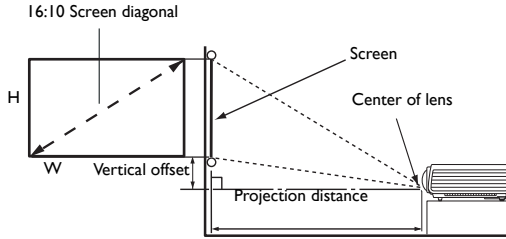

The screen aspect ratio is 16:10 and the projected picture is 16:10

Screen size				Distance from screen (mm)			Vertical offset (mm)
Diagonal		W (mm)	H (mm)	Min length	Average	Max length	
Inch	mm			(max. zoom)		(min. zoom)	
40	1016	862	538	625	688	750	13
60	1524	1292	808	938	1031	1125	20
80	2032	1723	1077	1250	1375	1500	27
100	2540	2154	1346	1563	1719	1875	34
120	3048	2585	1615	1875	2063	2250	40
140	3556	3015	1885	2188	2406	2625	47
160	4064	3446	2154	2500	2750	3000	54
180	4572	3877	2423	2813	3094	3375	61
200	5080	4308	2692	3125	3438	3750	67
250	6350	5385	3365	3906	4297	4688	84
300	7620	6462	4039	4688	5156	5625	101

For example, if you are using an 120-inch screen, the recommended projection distance is 2063 mm and the vertical offset is 40 mm.

If your measured projection distance is 3.0 m (3000 mm), the closest match in the "Distance from screen (mm)" column is 3094 mm. Looking across this row shows that a 180" (about 4.6 m) screen is required.

 All measurements are approximate and may vary from the actual sizes.

BenQ recommends that if you intend to permanently install the projector, you should physically test the projection size and distance using the actual projector in situ before you permanently install it, so as to make allowance for this projector's optical characteristics. This will help you determine the exact mounting position so that it best suits your installation location.

# Connection

When connecting a signal source to the projector, be sure to:

1. Turn all equipment off before making any connections.
2. Use the correct signal cables for each source.
3. Ensure the cables are firmly inserted.

 In the connections shown below, some cables may not be included with the projector (see "Shipping contents" on page 8). They are commercially available from electronics stores.

• The connection illustrations below are for reference only. The rear connecting jacks available on the projector vary with each projector model.

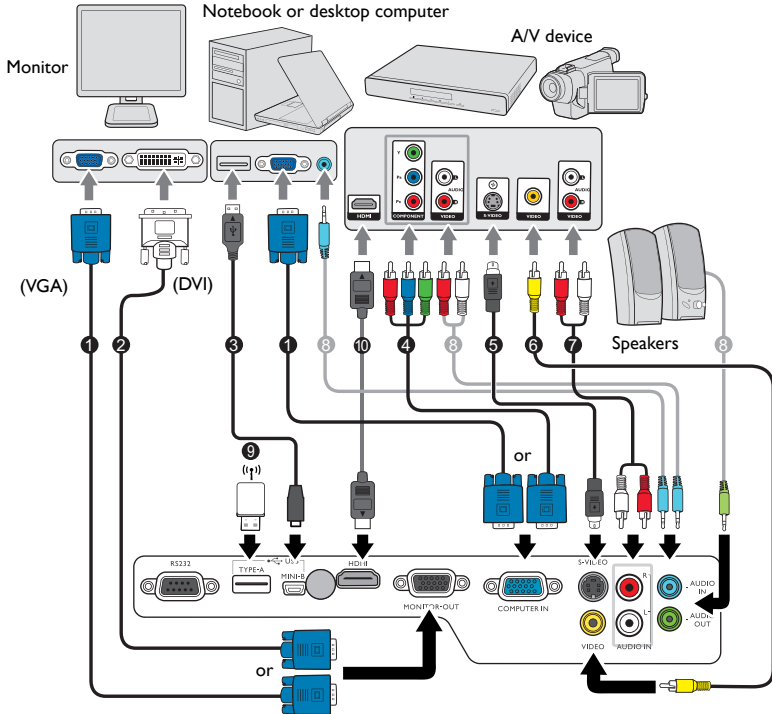

- |  |  |
|--|--|
| <ol style="list-style-type: none"> <li>1. VGA cable</li> <li>2. VGA to DVI-A cable</li> <li>3. USB cable</li> <li>4. Component Video to VGA (D-Sub) adapter cable</li> <li>5. S-Video cable</li> </ol> | <ol style="list-style-type: none"> <li>6. Video cable</li> <li>7. Audio L/R cable</li> <li>8. Audio cable</li> <li>9. USB flash drive/USB wireless dongle</li> <li>10. HDMI cable</li> </ol> |
|--|--|

 Many notebooks do not turn on their external video ports when connected to a projector. Usually a key combo like FN + F3 or CRT/LCD key turns the external display on/off. Locate a function key labeled CRT/LCD or a function key with a monitor symbol on the notebook. Press FN and the labeled function key simultaneously. Refer to your notebook's documentation to find your notebook's key combination.









• The D-Sub output only works when an appropriate D-Sub input is made to the **COMPUTER** jack.



- If you wish to use this connection method when the projector is in standby mode, make sure the **Monitor Out** function is turned on in the **SYSTEM SETUP: Advanced** menu. See "[Standby Settings](#)" on [page 47](#) for details.

## Connecting video source devices

You need only connect the projector to a video source device using just one of the connecting methods, however each provides a different level of video quality. The method you choose will most likely depend upon the availability of matching terminals on both the projector and the video source device as described below:

Terminal name	Terminal appearance	Picture quality
<b>HDMI</b>		 Best
<b>Component Video</b>		 Better
<b>S-Video</b>		 Good
<b>Video</b>		 Normal

### Connecting audio

The projector has built-in mono speaker(s) which are designed to provide basic audio functionality accompanying data presentations for business purposes only. They are not designed for, nor intended for stereo audio reproduction use as might be expected in home theater or home cinema applications. Any stereo audio input (if provided), is mixed into a common mono audio output through the projector speaker(s).

The built-in speaker(s) will be muted when the **AUDIO OUT** jack is connected.

-  • The projector is only capable of playing mixed mono audio, even if a stereo audio input is connected. See "[Connecting audio](#)" on [page 17](#) for details.
- If the selected video image is not displayed after the projector is turned on and the correct video source has been selected, check that the video source device is turned on and operating correctly. Also check that the signal cables have been connected correctly.

# Operation

## Starting up the projector

1. Plug the power cord into the projector and into a power outlet. Turn on the power outlet switch (where fitted). Check that the **POWER indicator light** on the projector lights orange after power has been applied.

 Please use the original accessories (e.g. power cord) only with the device to avoid possible dangers such as electric shock and fire.

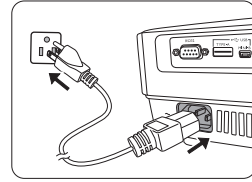

2. Press  **POWER** to start the projector. As soon as the lamp lights up, a "**Power On Ring Tone**" will be heard. The **POWER indicator light** flashes green and stays green when the projector is on.

The start up procedure takes about 30 seconds. In the later stage of start up, a startup logo is projected.

(If necessary) Rotate the focus ring to adjust the image clearness.

To turn off the ring tone, see "[Turning off the Power On/Off Ring Tone](#)" on page 34 for details.

 If the projector is still hot from previous activity, it will run the cooling fan for approximately 90 seconds before energizing the lamp.

3. If the projector is activated for the first time, select your OSD language following the on-screen instructions.
4. If you are prompted for a password, press the arrow keys to enter a six-digit password. See "[Utilizing the password function](#)" on page 22 for details.
5. Switch all of the connected equipment on.
6. The projector will start to search for input signals. The current input signal being scanned appears in the upper left corner of the screen. If the projector doesn't detect a valid signal, the message "No Signal" will continue displaying until an input signal is found.

Please select language			
English	한국어	Hrvatski	हिन्दी
Français	Svenska	Română	
Deutsch	Nederlands	Norsk	
Italiano	Türkçe	Dansk	
Español	Čeština	Български	
Русский	Português	suomi	
繁體中文	ไทย	Indonesian	
简体中文	Polski	Ελληνικά	
日本語	Magyar	العربية	
Press Enter to Confirm, Exit to leave			

You can also press **SOURCE** on the projector or remote control to select your desired input signal. See "[Switching input signal](#)" on page 24 for details.

 If the frequency/resolution of the input signal exceeds the projector's operating range, you will see the message "Out of Range" displayed on the background screen. Please change to an input signal which is compatible with the projector's resolution or set the input signal to a lower setting. See "[Timing chart](#)" on page 58 for details.

- If no signal is detected for 3 minutes, the projector automatically enters ECO BLANK mode.

# Adjusting the projected image

## Adjusting the projection angle

The projector is equipped with 1 quick-release adjuster foot and 1 rear adjuster foot. These adjusters change the image height and projection angle. To adjust the projector:

1. Press the quick-release button and lift the front of the projector. Once the image is positioned where you want it, release the quick-release button to lock the foot in position.
2. Screw the rear adjuster foot to fine-tune the horizontal angle.

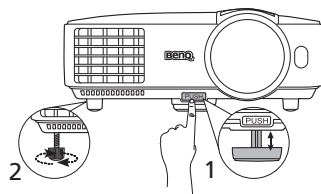

To retract the foot, hold up the projector while pressing the quick-release button, then slowly lower the projector. Screw the rear adjuster foot in a reverse direction.

If the projector is not placed on a flat surface or the screen and the projector are not perpendicular to each other, the projected image becomes trapezoidal. To correct this situation, see ["Correcting keystone" on page 20](#) for details.

 Do not look into the lens while the lamp is on. The strong light from the lamp may cause damage to your eyes.

Be careful when you press the quick-release button as it is close to the exhaust vent where hot air comes from.

## Auto-adjusting the image

In some cases, you may need to optimize the picture quality. To do this, press **AUTO** on the projector or remote control. Within 3 seconds, the built-in Intelligent Auto Adjustment function will re-adjust the values of Frequency and Clock to provide the best picture quality.

The current source information will be displayed in the corner of the screen for 3 seconds.

 This function is only available when PC signal (analog RGB) is selected.

## Fine-tuning the image size and clarity

1. Adjust the projected image to the size that you need using the zoom ring.
2. Sharpen the image by rotating the focus ring.

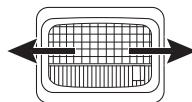
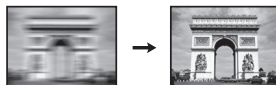
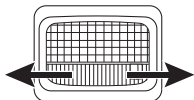

## Correcting keystone

Keystoning refers to the situation where the projected image is noticeably wider at either the top or bottom. It occurs when the projector is not perpendicular to the screen.

To correct this, you will need to manually correct it following **ONE** of these steps.

- Press  $\triangle$  /  $\nabla$  on the projector or remote control to display the Keystone correction page. Press  $\triangle$  to correct keystone at the top of the image. Press  $\nabla$  to correct keystone at the bottom of the image.



- Using the OSD menu
  1. Press **MENU/EXIT** and then press  $\blacktriangleleft$  /  $\blacktriangleright$  until the **DISPLAY** menu is highlighted.
  2. Press  $\blacktriangledown$  to highlight **Keystone** and press **MODE/ENTER**. The **Keystone** correction page appears.
  3. Press  $\triangle$  to correct keystone at the top of the image. Press  $\nabla$  to correct keystone at the bottom of the image.

# Using the menus

The projector is equipped with On-Screen Display (OSD) menus for making various adjustments and settings.

 The OSD screenshots below are for reference only, and may differ from the actual design.

Below is the overview of the OSD menu.



The following example describes how to set the OSD language.

1. Press **MENU/EXIT** on the projector or remote control to turn the OSD menu on.
3. Press **▼** to highlight **Language** and press **MODE/ENTER**.



2. Use **◀/▶** to highlight the **SYSTEM SETUP: Basic** menu.
4. Press **◀/▶/▲/▼** to select a preferred language and press **MODE/ENTER**.
5. Press **MENU/EXIT** on the projector or remote control to leave and save the settings.



# Securing the projector

## Using a security cable lock

The projector has to be installed in a safe place to prevent theft. Otherwise, purchase a lock, such as the Kensington lock, to secure the projector. You can locate a Kensington lock slot on the rear side of the projector. See item 22 on page 9 for details.

A Kensington security cable lock is usually a combination of key(s) and the lock. Refer to the lock's documentation for finding out how to use it.

## Utilizing the password function

For security purposes and to help prevent unauthorized use, the projector includes an option for setting up password security. The password can be set through the On-Screen Display (OSD) menu.

 **WARNING:** You will be inconvenienced if you activate the password functionality and subsequently forget the password. Print out this manual (if necessary) and write the password you used in this manual, and keep the manual in a safe place for later recall.

### Setting a password

 Once a password has been set and the power on lock is activated, the projector cannot be used unless the correct password is entered every time the projector is started.

1. Open the OSD menu and go to the **SYSTEM SETUP: Advanced > Security Settings** menu. Press **MODE/ENTER**. The **Security Settings** page appears.
2. Highlight **Change Security Settings** and press **MODE/ENTER**.
3. As pictured to the right, the four arrow keys (▲, ►, ▼, ◀) respectively represent 4 digits (1, 2, 3, 4). According to the password you desire to set, press the arrow keys to enter six digits for the password.

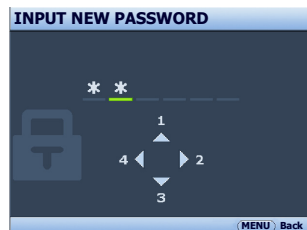

4. Confirm the new password by re-entering the new password.  
Once the password is set, the OSD menu returns to the **Security Settings** page.
5. To activate the **Power On Lock** function, press ▲/▼ to highlight **Power On Lock** and press ◀/▶ to select **On**.
6. To activate the **Web Control Lock** function, press ▲/▼ to highlight **Web Control Lock** and press ◀/▶ to select **On**. When the **Web Control Lock** function is activated, you have to enter the correct password to change projector settings via the Projector Network Display System.

 **IMPORTANT:** The digits being input will display as asterisks on-screen. Write your selected password down here in this manual in advance or right after the password is entered so that it is available to you should you ever forget it.

Password: \_\_\_\_\_

Keep this manual in a safe place.

7. To leave the OSD menu, press **MENU/EXIT**.

## If you forget the password

If the password function is activated, you will be asked to enter the six-digit password every time you turn on the projector. If you enter the wrong password, the password error message as pictured to the right displays lasting for 3 seconds, and the **INPUT PASSWORD** message follows. You can retry by entering another six-digit password, or if you did not record the password in this manual, and you absolutely do not remember it, you can use the password recall procedure. See ["Entering the password recall procedure" on page 23](#) for details.

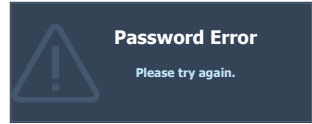

If you enter an incorrect password 5 times in succession, the projector will automatically shut down in a short time.

## Entering the password recall procedure

1. Press and hold **AUTO** on the projector or remote control for 3 seconds. The projector will display a coded number on the screen.
2. Write down the number and turn off your projector.
3. Seek help from the local BenQ service center to decode the number. You may be required to provide proof of purchase documentation to verify that you are an authorized user of the projector.

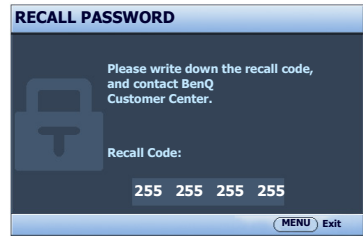

## Changing the password

1. Open the OSD menu and go to the **SYSTEM SETUP: Advanced > Security Settings > Change Password** menu.
2. Press **MODE/ENTER**. The message **"INPUT CURRENT PASSWORD"** appears.
3. Enter the old password.
  - i. If the password is correct, another message **"INPUT NEW PASSWORD"** appears.
  - ii. If the password is incorrect, the password error message appears lasting for three seconds, and the message **"INPUT CURRENT PASSWORD"** appears for your retry. You can press **MENU/EXIT** to cancel the change or try another password.
4. Enter a new password.



**IMPORTANT:** The digits being input will display as asterisks on-screen. Write your selected password down here in this manual in advance or right after the password is entered so that it is available to you should you ever forget it.

Password: \_\_\_\_\_

Keep this manual in a safe place.

5. Confirm the new password by re-entering the new password.
6. You have successfully assigned a new password to the projector. Remember to enter the new password next time the projector is started.
7. To leave the OSD menu, press **MENU/EXIT**.

## Disabling the password function

To disable password protection, go back to the **SYSTEM SETUP: Advanced > Security Settings > Change Security Settings** menu after opening the OSD menu system. Press **MODE/ENTER**. The message **"INPUT PASSWORD"** appears. Enter the current password.

- i. If the password is correct, the OSD menu returns to the **Security Settings** page.  
Press **▼** to highlight **Power On Lock** and press **◀/▶** to select **Off**. You will not have to enter the password next time when turning on the projector.  
Press **▼** to highlight **Web Control Lock** and press **◀/▶** to select **Off**. Now the **Web Control Lock** is released and projector settings can be changed via the Projector Network Display System.
- ii. If the password is incorrect, the password error message appears lasting for three seconds, and the message **"INPUT PASSWORD"** appears for your retry. You can press **MENU/EXIT** to cancel the change or try another password.

 Though the password function is disabled, you need to keep the old password in hand should you ever need to re-activate the password function by entering the old password.

## Switching input signal

The projector can be connected to multiple devices at the same time. However, it can only display one full screen at a time. When starting up, the projector automatically searches for the available signals.

Be sure the **Quick Auto Search** function in the **SOURCE** menu is **On** if you want the projector to automatically search for the signals.

To select the source:

1. Press **SOURCE** on the projector or remote control. A source selection bar appears.
2. Press **▲/▼** until your desired signal is selected and press **MODE/ENTER**.

Once detected, the selected source information will display at the corner of the screen for seconds. If there is multiple equipment connected to the projector, repeat steps 1-2 to search for another signal.

-  • The brightness level of the projected image will change accordingly when you switch between different input signals. Data (graphic) "PC" presentations using mostly static images are generally brighter than "Video" using mostly moving images (movies).
- The native display resolution of this projector is in a 4:3 (MS619ST/MX620ST)/16:10 (MV621ST) aspect ratio. For best display picture results, you should select and use an input signal which outputs at this resolution. Any other resolutions will be scaled by the projector depending upon the "aspect ratio" setting, which may cause some image distortion or loss of picture clarity. See ["Selecting the aspect ratio" on page 26](#) for details.
  - Firewall in the PC must be switched off to allow USB Display to work.

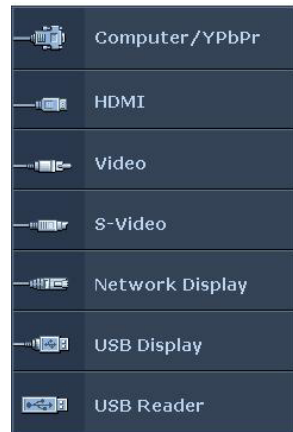



## Changing Color Space

In the unlikely event that you connect the projector to a DVD player via the projector's **HDMI** input and the projected picture displays wrong colors, please change the color space to **YUV**.

To do this:

1. Press **MENU/EXIT** and then press ◀/▶ until the **SOURCE** menu is highlighted.
2. Press ▼ to highlight **Color Space Conversion** and press ◀/▶ to select a suitable color space.

 This function is only available when the HDMI-input port is in use.

## Magnifying and searching for details

If you need to find the details on the projected picture, magnify the picture. Use the direction arrow keys for navigating the picture.

- Using the remote control
  1. Press **Digital Zoom+/-** to display the Zoom bar. Press **Digital Zoom+** to magnify the center of the picture. Press the key repeatedly until the picture size is suitable for your need.
  2. Use the directional arrows (▲, ▼, ◀, ▶) on the projector or remote control to navigate the picture.
  3. To restore the picture to its original size, press **AUTO**. You can also press **Digital Zoom-**. When the key is pressed again, the picture is further reduced until it is restored to the original size.
- Using the OSD menu
  1. Press **MENU/EXIT** and then press ◀/▶ until the **DISPLAY** menu is highlighted.
  2. Press ▼ to highlight **Digital Zoom** and press **MODE/ENTER**. The Zoom bar appears.
  3. Press ▲ repeatedly to magnify the picture to a desired size.
  4. To navigate the picture, press **MODE/ENTER** to switch to the panning mode and press the directional arrows (▲, ▼, ◀, ▶) on the projector or remote control to navigate the picture.
  5. To reduce size of the picture, press **MODE/ENTER** to switch back to the zoom in/out function, and press **AUTO** to restore the picture to its original size. You can also press ▼ repeatedly until it is restored to the original size.

 The picture can only be navigated after it is magnified. You can further magnify the picture while searching for details.

# Selecting the aspect ratio

The “aspect ratio” is the ratio of the image width to the image height. Most analog TV and some computers are in 4:3 ratio, and digital TV and DVDs are usually in 16:9 ratio.

With the advent of digital signal processing, digital display devices like this projector can dynamically stretch and scale the image output to a different aspect than that of the image input signal.

To change the projected picture ratio (no matter what aspect the source is):

- Using the remote control
  1. Press **Aspect** to show the current setting.
  2. Press **Aspect** repeatedly to select an aspect ratio to suit the format of the video signal and your display requirements.
- Using the OSD menu
  1. Press **MENU/EXIT** and then press ◀/▶ until the **DISPLAY** menu is highlighted.
  2. Press ▼ to highlight **Aspect Ratio**.
  3. Press ◀/▶ to select an aspect ratio to suit the format of the video signal and your display requirements.

## About the aspect ratio

-  In the pictures below, the black portions are inactive areas and the white portions are active areas.
- OSD menus can be displayed on those unused black areas.

- 
- 1. Auto:** Scales an image proportionally to fit the projector's native resolution in its horizontal or vertical width. This is suitable for the incoming image which is neither in 4:3 nor 16:9 and you want to make most use of the screen without altering the image's aspect ratio.

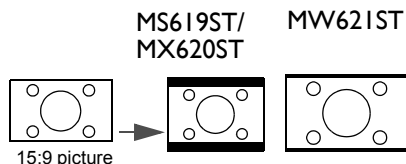

- 2. Real:** The image is projected as its original resolution, and resized to fit within the display area. For input signals with lower resolutions, the projected image will display smaller than if resized to full screen. You could adjust the zoom setting or move the projector towards the screen to increase the image size if necessary. You may also need to refocus the projector after making these adjustments.

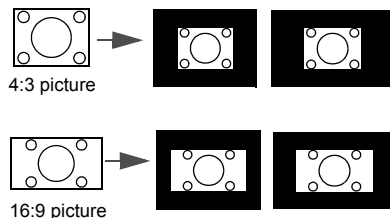

- 3. 4:3:** Scales an image so that it is displayed in the center of the screen with a 4:3 aspect ratio. This is most suitable for 4:3 images like some computer monitors, standard definition TV and 4:3 aspect DVD movies, as it displays them without aspect alteration.

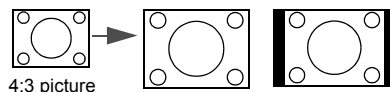

- 4. 16:9:** Scales an image so that it is displayed in the center of the screen with a 16:9 aspect ratio. This is most suitable for images which are already in a 16:9 aspect, like high definition TV, as it displays them without aspect alteration.

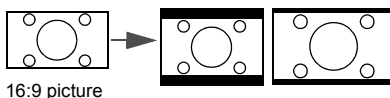

- 5. 16:10:** Scales an image so that it is displayed in the center of the screen with a 16:10 aspect ratio. This is most suitable for images which are already in a 16:10 aspect, as it displays them without aspect alteration.

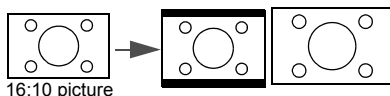

# Optimizing the image

## Using Wall Color

In the situation where you are projecting onto a colored surface such as a painted wall which may not be white, the Wall Color feature can help correct the projected picture's colors to prevent possible color difference between the source and projected pictures.

To use this function, go to the **DISPLAY > Wall Color** menu and press **◀/▶** to select a color which is closest to the color of the projection surface. There are several precalibrated colors to choose from: **Light Yellow, Pink, Light Green, Blue,** and **Blackboard**.

## Selecting a picture mode

The projector is preset with several predefined picture modes so that you can choose one to suit your operating environment and input signal picture type.

To select an operation mode that suits your need, you can follow one of the following steps.

- Press **MODE/ENTER** on the projector or remote control repeatedly until your desired mode is selected.
- Go to the **PICTURE > Picture Mode** menu and press **◀/▶** to select a desired mode.
  1. **Dynamic mode:** Maximizes the brightness of the projected image. This mode is suitable for environments where extra-high brightness is required, such as using the projector in well lit rooms.
  2. **Presentation mode:** Is designed for presentations. The brightness is emphasized in this mode to match PC and notebook coloring.
  3. **sRGB mode:** Maximizes the purity of RGB colors to provide true-to-life images regardless of brightness setting. It is most suitable for viewing photos taken with an sRGB compatible and properly calibrated camera, and for viewing PC graphic and drawing applications such as AutoCAD.
  4. **Cinema mode:** Is appropriate for playing colorful movies, video clips from digital cameras or DVs through the PC input for best viewing in a blackened (little light) environment.
  5. **3D mode:** Is appropriate for playing 3D content and 3D video clips.
  6. **User 1/User 2 mode:** Recalls the settings customized based on the current available picture modes. See "[Setting the User 1/User 2 mode](#)" on page 28 for details.

## Setting the User 1/User 2 mode

There are two user-definable modes if the current available picture modes are not suitable for your need. You can use one of the picture modes (except the **User 1/2**) as a starting point and customize the settings.

1. Press **MENU/EXIT** to open the On-Screen Display (OSD) menu.
2. Go to the **PICTURE > Picture Mode** menu.
3. Press **◀/▶** to select **User 1** or **User 2**.
4. Press **▼** to highlight **Reference Mode**.



This function is only available when **User 1** or **User 2** mode is selected up in the **Picture Mode** sub-menu item.

5. Press **◀/▶** to select a picture mode that is closest to your need.

6. Press ▼ to select a menu item to be changed and adjust the value with ◀/▶ . See "Fine-tuning the image quality in user modes" below for details.

## Fine-tuning the image quality in user modes

According to the detected signal type and selected picture mode, some of the below functions may not be available. Based on your needs, you can make adjustments to these functions by highlighting them and pressing ◀/▶ on the projector or remote control.

### Adjusting **Brightness**

The higher the value, the brighter the image. And the lower the setting, the darker the image. Adjust this control so the black areas of the image appear just as black and that detail in the dark areas is visible.



### Adjusting **Contrast**

The higher the value, the greater the contrast. Use this to set the peak white level after you have previously adjusted the Brightness setting to suit your selected input and viewing environment.



### Adjusting **Color**

Lower setting produces less saturated colors. If the setting is too high, colors on the image will be overpowering, which makes the image unrealistic.

### Adjusting **Tint**

The higher the value, the more reddish the picture becomes. The lower the value, the more greenish the picture becomes.

### Adjusting **Sharpness**

The higher the value, the sharper the picture becomes. The lower the value, the softer the picture becomes.

### Adjusting **Brilliant Color**

This feature utilizes a new color-processing algorithm and system level enhancements to enable higher brightness while providing truer, more vibrant colors in picture. It enables a greater than 50% brightness increase in mid-tone images, which are common in video and natural scenes, so the projector reproduces images in realistic and true colors. If you prefer images with that quality, select **On**. If you don't need it, select **Off**.

When **Off** is selected, the **Color Temperature** function is not available.

### Selecting a **Color Temperature**

The options available for color temperature\* settings vary according to the signal type selected.

1. **Cool:** Makes images appear bluish white.
2. **Normal:** Maintains normal colorings for white.
3. **Warm:** Makes images appear reddish white.

#### \*About color temperatures:

There are many different shades that are considered to be "white" for various purposes. One of the common methods of representing white color is known as the "color temperature". A white color with a low color temperature appears to be reddish white. A white color with a high color temperature appears to have more blue in it.

## Setting a preferred color temperature

To set a preferred color temperature:

1. Highlight **Color Temperature** and select **Warm**, **Normal** or **Cool** by pressing ◀/▶ on the projector or remote control.
2. Press ▼ to highlight **Color Temperature Fine Tuning** and press **MODE/ENTER**. The **Color Temperature Fine Tuning** page displays.
3. Press ▲/▼ to highlight the item you want to change and adjust the values by pressing ◀/▶ .
  - **R Gain/G Gain/B Gain**: Adjusts the contrast levels of Red, Green, and Blue.
  - **R Offset/G Offset/B Offset**: Adjusts the brightness levels of Red, Green, and Blue.

Press **MENU/EXIT** to exit and save the settings.

## 3D Color Management

In most installation situations, color management will not be necessary, such as in classroom, meeting room, or lounge room situations where lights remain on, or where building external windows allow daylight into the room.

Only in permanent installations with controlled lighting levels such as boardrooms, lecture theaters, or home theaters, should color management be considered. Color management provides fine color control adjustment to allow for more accurate color reproduction, should you require it.

Proper color management can only be achieved under controlled and reproducible viewing conditions. You will need to use a colorimeter (color light meter), and provide a set of suitable source images to measure color reproduction. These tools are not provided with the projector; however, your projector supplier should be able to provide you with suitable guidance, or even an experienced professional installer.

The Color Management provides six sets (RGBCMY) of colors to be adjusted. When you select each color, you can independently adjust its range and saturation according to your preference.

If you have purchased a test disc which contains various color test patterns and can be used to test the color presentation on monitors, TVs, projectors, etc, you can project any image from the disc on the screen and enter the **3D Color Management** menu to make adjustments.

To adjust the settings:

1. Go to the **PICTURE** menu and highlight **3D Color Management**.
2. Press **MODE/ENTER** on the projector or remote control and the **3D Color Management** page appears.
3. Highlight **Primary Color** and press ◀/▶ to select a color from among Red, Yellow, Green, Cyan, Blue, or Magenta.
4. Press ▼ to highlight **Hue** and press ◀/▶ to select its range. Increase in the range will include colors consisted of more proportions of its two adjacent colors.

Please refer to the illustration to the right for how the colors relate to each other.

For example, if you select Red and set its range at 0, only pure red in the projected picture will be selected. Increasing its range will include red close to yellow and red close to magenta.

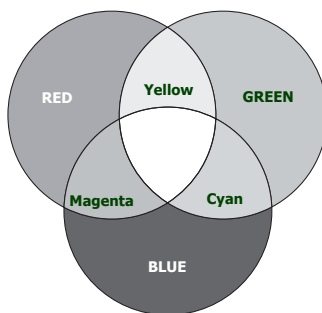

5. Press **▼** to highlight **Saturation** and adjust its values to your preference by pressing **◀/▶**. Every adjustment made will reflect to the image immediately.

For example, if you select Red and set its value at 0, only the saturation of pure red will be affected.

**Saturation** is the amount of that color in a video picture. Lower settings produce less saturated colors; a setting of "0" removes that color from the image entirely. If the saturation is too high, that color will be overpowering and unrealistic.

6. Press **▼** to highlight **Gain** and adjust its values to your preference by pressing **◀/▶**. The contrast level of the primary color you select will be affected. Every adjustment made will reflect to the image immediately.
7. Repeat steps 3 to 6 for other color adjustments.
8. Make sure you have made all of the desired adjustments.
9. Press **MENU/EXIT** to exit and save the settings.

### Resetting current or all picture modes

1. Go to the **PICTURE** menu and highlight **Reset Picture Settings**.
2. Press **MODE/ENTER** and press **▲/▼** to select **Current** or **All**.
  - **Current**: returns current picture mode to the factory preset settings.
  - **All**: returns all settings, except **User 1/User 2** in the **PICTURE** menu to the factory preset settings.

## Setting the presentation timer

Presentation timer can indicate the presentation time on the screen to help you achieve better time management when giving presentations. Follow these steps to utilize this function:

1. Go to the **SYSTEM SETUP: Basic > Presentation Timer** menu and press **MODE/ENTER** to display the **Presentation Timer** page.
2. Highlight **Timer Period** and decide the time period by pressing **◀/▶**. The length of time can be set from 1 to 5 minutes in 1-minute increments and 5 to 240 minutes in 5-minute increments.

If the timer is already on, the timer will restart whenever the Timer Period is reset.

3. Press **▼** to highlight **Timer Display** and choose if you want the timer to show up on the screen by pressing **◀/▶**.

Selection	Description
Always	Displays the timer on screen throughout the presentation time.
3 min/2 min/1 min	Displays the timer on screen in the last 3/2/1 minute(s).
Never	Hides the timer throughout the presentation time.

- Press ▼ to highlight **Timer Position** and set the timer position by pressing ◀/▶.

Top-Left → Bottom-Left → Top-Right → Bottom-Right

- Press ▼ to highlight **Timer Counting Direction** and select your desired counting direction by pressing ◀/▶.

Selection	Description
Count Up	Increases from 0 to the preset time.
Count Down	Decreases from the preset time to 0.

- Press ▼ to highlight **Sound Reminder** and decide if you want to activate sound reminder by pressing ◀/▶. If you select **On**, a double beep sound will be heard at the last 30 seconds of counting down/up, and a triple beep sound will be produced when the timer is up.
- To activate the presentation timer, press ▼ and press ◀/▶ to highlight **On** and press **MODE/ENTER**.
- A confirmation message appears. Highlight **Yes** and press **MODE/ENTER** on the projector or remote control to confirm. You will see the message “**Timer is On**” displaying on the screen. The timer starts counting when the timer is on.

To cancel the timer, perform the following steps:

- Go to the **SYSTEM SETUP: Basic > Presentation Timer** menu and highlight **Off**. Press **MODE/ENTER**. A confirmation message appears.
- Highlight **Yes** and press **MODE/ENTER** to confirm. You will see the message “**Timer is Off**” displaying on the screen.

## Remote paging operations

Connect the projector to your PC or notebook with a USB cable prior to using the paging function. See “[Connection](#)” on page 16 for details.

You can operate your display software program (on a connected PC) which responds to page up/down commands (like Microsoft PowerPoint) by pressing **Page Up/Page Down** on the remote control.

If remote paging function doesn't work, check if the USB connection is correctly made and the mouse driver on your computer is updated to the latest version.

 The remote paging function cannot work with Microsoft® Windows®98 operating system. Windows®XP or higher operating systems are recommended.

## Freezing the image

Press **Freeze** on the remote control to freeze the image. The word “**FREEZE**” will appear in the upper left corner of the screen. To release the function, press any key on the projector or remote control.

 If your remote control has the following keys, please note that they cannot be pressed to release the function: **LASER**, #1, #4, **Page Up/Page Down**.

Even if an image is frozen on the screen, the pictures are running on the video or other device. If the connected devices have active audio output, you will still hear the audio even though the image is frozen onscreen.



## Hiding the image

In order to draw the audience's full attention to the presenter, you can use **ECO BLANK** on the projector or remote control to hide the screen image. When this function is activated with an audio input connected, the audio can still be heard.

You can set the blank time in the **SYSTEM SETUP: Basic > Operation Settings > Blank Timer** menu to let the projector return the image automatically after a period of time when there is no action taken on the blank screen.

If the preset time spans are not suitable for your presentation, select **Disable**.

No matter **Blank Timer** is activated or not, you can press most of the keys on the projector or remote control to restore the picture.

To provide you a quick and friendly way to temporarily hide the screen image, the projector is equipped with a sensor to detect any object approaching the projection lens and enters blank status automatically in a short time once the object is within 30 degrees perpendicular to the sensor and 10 cm from the sensor. Moving the object away from the effective range will also return the projector to normal projection status within a few seconds.

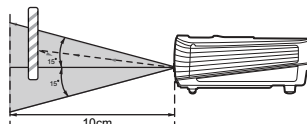





Be sure the **SYSTEM SETUP: Basic > Operation Settings > Auto Blank** menu is **On**.

 The effective range of the sensor may vary according to the material and color of the blocking object.

## Locking control keys

With the control keys on the projector locked, you can prevent your projector settings from being changed accidentally (by children, for example). When the **Panel Key Lock** is on, no control keys on the projector will operate except  **POWER**.

1. Go to the **SYSTEM SETUP: Basic > Panel Key Lock** menu, and select **On** by pressing   on the projector or remote control. A confirmation message appears.
2. Highlight **Yes** and press **MODE/ENTER** to confirm.

To release panel key lock, use the remote control to enter the **SYSTEM SETUP: Basic > Panel Key Lock** menu and press   to select **Off**.



-  • Keys on the remote control are still active when panel key lock is enabled.
- If you turn off the projector without disabling panel key lock, the projector will still be in locked status the next time it is turned on.

## Operating in a high altitude environment

We recommend you use the **High Altitude Mode** when your environment is between 1500 m –3000 m above sea level, and ambient temperature is between 0°C–35°C.

 Do not use the **High Altitude Mode** if your altitude is between 0 m and 1500 m and ambient temperature is between 0°C and 35°C. The projector will be over cooled, if you turn the mode on under such a condition.

To activate the **High Altitude Mode**:

1. Press **MENU/EXIT** and then press   until the **SYSTEM SETUP: Advanced** menu is highlighted.

2. Press ▼ to highlight **High Altitude Mode** and press ◀/▶ select **On**. A confirmation message appears.
3. Highlight **Yes** and press **MODE/ENTER**.

Operation under "**High Altitude Mode**" may cause a higher decibel operating noise level because of increased fan speed necessary to improve overall system cooling and performance.

If you use this projector under other extreme conditions excluding the above, it may display auto shut-down symptoms, which is designed to protect your projector from overheating. In cases like this, you should switch to High Altitude mode to solve these symptoms. However, this is not to state that this projector can operate under any and all harsh or extreme conditions.

## Adjusting the sound

The sound adjustments made as below will have an effect on the projector speaker(s). Be sure you have made a correct connection to the projector audio input. See "[Connection](#)" on page 16 for how the audio input is connected.

### Muting the sound

To temporarily turn off the sound:

1. Press **MENU/EXIT** and then press ◀/▶ until the **SYSTEM SETUP: Advanced** menu is highlighted.
2. Press ▼ to highlight **Audio Settings** and press **MODE/ENTER**. The **Audio Settings** page appears.
3. Highlight **Mute** and press ◀/▶ to select **On**.

☞ If available, you can also press **Mute** on the remote control to toggle projector audio between on and off.

### Adjusting the sound level

To adjust the sound level, press **Volume +/-** or , or:

1. Repeat steps 1-2 above.
2. Press ▼ to highlight **Volume** and press ◀/▶ to select a desired sound level.

### Turning off the Power On/Off Ring Tone

To turn off the ring tone:

1. Repeat steps 1-2 above.
2. Press ▼ to highlight **Power On/Off Ring Tone** and press ◀/▶ to select **Off**.

☞ The only way to change **Power On/Off Ring Tone** is setting On or Off here. Setting the sound mute or changing the sound level will not affect the **Power On/Off Ring Tone**.

## Using the test pattern

The projector is able to display the grid test pattern. It helps you adjust the image size and focus and check that the projected image is free from distortion.



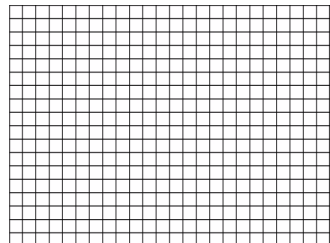

To display the test pattern, open the OSD menu and go to the **SYSTEM SETUP: Advanced > Test Pattern** and press ◀/▶ to select **On**.



# Using the teaching templates

The projector provides several preset patterns for various teaching purposes. To activate the pattern:

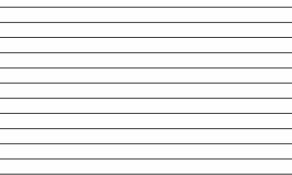
1. Open the OSD menu and go to the **DISPLAY > Teaching Template** and press **▲/ ▼** to select **Blackboard** or **Whiteboard**.
2. Press **◀/▶** to choose the pattern you need.
3. Press **MODE/ENTER** to activate the pattern.

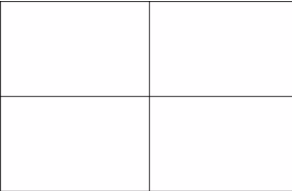
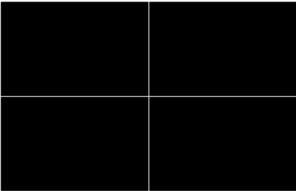
Teaching Template	Whiteboard	Blackboard
<p><b>Letter Formation</b></p>		
<p><b>Worksheet</b></p>		
<p><b>Coordinate Chart</b></p>		

# Presenting from a USB Reader

This feature displays a slide show of images stored on a USB flash drive connected to the projector. It can eliminate the need for a computer source.

Supported image formats:

- JPEG(JPG)
- PNG
- TIFF
- BMP
- GIF



- A square box will display on the filename for unidentified characters.
- Thai filename is not supported.
- Files in GIF, TIFF, PNG and BMP formats can be displayed for the file size smaller than WXGA (1280 x 800) only.
- If a folder consists of more than 200 photos, only the first 200 photos can be displayed.

To view your pictures as a slide show, follow these steps:

1. Plug the USB flash drive into the USB TYPE-A jack of the projector.
2. The projector automatically displays the thumbnails. Or you can manually select **USB Reader** from the source selection bar.

When viewing thumbnails

To	Press
open the folder	Enter
scroll through thumbnails	four arrow keys
return to a previous page	Auto
exit USB Reader	Exit
change to a different page	◀/▶
go back to the first page of that folder	Back
start a slide show	Slideshow when an image is highlighted.
adjust USB Reader settings	Setting

During a slide show

To	Press
go to the previous or next image	◀/▶
rotate the image by 90 degree clockwise/ counterclockwise	▲/▼ (Rotation is temporary; the image returns to its original orientation when you go back to thumbnails)
return to a previous page	Auto
start/stop a slide show	Enter

Setting page

You can adjust the file order and Slideshow settings. When you are done, press OK to save the settings or press Cancel to ignore the change.

# Shutting down the projector

1. Press **POWER** and a confirmation message will appear prompting you.  
If you don't respond in a few seconds, the message will disappear.
2. Press **POWER** a second time. The **POWER indicator light** flashes orange, the projection lamp shuts down, and the fans will continue to run for approximately 90 seconds to cool down the projector.



To protect the lamp, the projector will not respond to any commands during the cooling process.

To shorten the cooling time, you can also activate the Quick cooling function. See "[Quick Cooling](#)" on page 45 for details.

3. Once the cooling process finishes, a "**Power Off Ring Tone**" will be heard. The **POWER indicator light** is a steady orange and fans stop. Disconnect the power cord from the power outlet.



- To turn off the power ring tone, see "[Turning off the Power On/Off Ring Tone](#)" on page 34 for details.
- If the projector is not properly shut down, to protect the lamp, when you attempt to re-start the projector, the fans will run for a few minutes to cool down. Press **POWER** again to start the projector after the fans stop and the **POWER indicator light** turns orange.
- Lamp life results will vary depending on environmental conditions and usage.

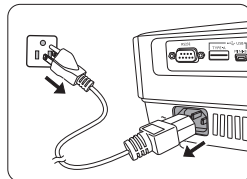

## Direct power off

The AC power cord can be pulled out right after the projector is turned off. To protect the lamp, wait about 10 minutes before re-starting the projector. (When you attempt to re-start the projector, the fans may run for a few minutes to cool down. In such cases, press **POWER** again to start the projector after the fans stop and the **POWER indicator light** turns orange.

# Menu operation

## Menu system

Please note that the on-screen display (OSD) menus vary according to the signal type selected and the projector model you are using.

Main menu	Sub-menu	Options	
<b>1. DISPLAY</b>	Wall Color	Off/Light Yellow/Pink/Light Green/Blue/Blackboard	
	Aspect Ratio	Auto/Real/4:3/16:9/16:10	
	Keystone		
	Position		
	Phase		
	H. Size		
	Digital Zoom		
	3D	3D Mode	Auto/Top Bottom/Frame Sequential/Frame Packing/Side by Side/Off
		3D Sync Invert	Disable/Invert
		Apply 3D Settings	3D Settings 1/3D Settings 2/3D Settings 3/Off
		Save 3D Settings	3D Settings 1/3D Settings 2/3D Settings 3
	Teaching Template	Blackboard	Off/Letter Formation/Worksheet/Coordinate Chart
		Whiteboard	Off/Letter Formation/Worksheet/Coordinate Chart
	<b>2. PICTURE</b>	Picture Mode	Dynamic/Presentation/sRGB/Cinema/(3D)/User 1/ User 2
Reference Mode		Dynamic/Presentation/sRGB/Cinema/(3D)	
Brightness			
Contrast			
Color			
Tint			
Sharpness			
Brilliant Color		On/Off	
Color Temperature		Cool/Normal/Warm	
Color Temperature Fine Tuning		R Gain/G Gain/B Gain/R Offset/G Offset/B Offset	
3D Color Management		Primary Color	R/G/B/C/M/Y
		Hue	
		Saturation	
		Gain	
Reset Picture Settings	Current/All/Cancel		
<b>3. SOURCE</b>	Quick Auto Search	On/Off	
	Color Space Conversion	Auto/RGB/YUV	





Main menu	Sub-menu	Options	
<b>4. SYSTEM SETUP: Basic</b>	<b>Presentation Timer</b>	<b>Timer Period</b>	1~240 minutes
		<b>Timer Display</b>	Always/3 min/2 min/1 min/ Never
		<b>Timer Position</b>	Top-Left/Bottom-Left/Top- Right/Bottom-Right
		<b>Timer Counting Direction</b>	Count Down/Count Up
		<b>Sound Reminder</b>	On/Off
	<b>Language</b>		English/Français/Deutsch Italiano/Español/Русский 繁體中文/简体中文/日本語/한국어/ Svenska/Nederlands/Türkçe/ Čeština/Português/ไทย/Polski Magyar/Hrvatski/Română/ Norsk/Dansk/Български/Suomi/ Indonesian/Ελληνικά/العربية/हिन्दी
	<b>Projector Installation</b>		Front Table/Rear Table/Rear Ceiling/Front Ceiling
	<b>Menu Settings</b>	<b>Menu Display Time</b>	5 sec/10 sec/20 sec/30 sec/ Always
		<b>Menu Position</b>	Center/Top-Left/Top-Right/ Bottom-Right/Bottom-Left
		<b>Reminder Message</b>	On/Off
	<b>Operation Settings</b>	<b>Direct Power On</b>	On/Off
		<b>Signal Power On</b>	On/Off
		<b>Auto Power Off</b>	Disable/3 min/10 min/15 min/20 min/25 min/30 min
		<b>Quick Cooling</b>	On/Off
		<b>Auto Blank</b>	On/Off
		<b>Instant Restart</b>	On/Off
		<b>Blank Timer</b>	Disable/5 min/10 min/15 min/20 min/25 min/30 min
		<b>Sleep Timer</b>	Disable/30 min/1 hr/2 hr/3 hr/4 hr/8 hr/12 hr
	<b>Remote Receiver</b>		Front+Rear/Front/Rear
	<b>Panel Key Lock</b>		On/Off
	<b>Background Color</b>		Black/Blue/Purple/BenQ
<b>Splash Screen</b>		Black/Blue/BenQ	



<b>Main menu</b>	<b>Sub-menu</b>	<b>Options</b>	
<b>5. SYSTEM SETUP: Advanced</b>	<b>High Altitude Mode</b>	<b>On/Off</b>	
	<b>Audio Settings</b>	<b>Mute</b>	<b>On/Off</b>
		<b>Volume</b>	
		<b>Power On/Off</b>	<b>On/Off</b>
		<b>Ring Tone</b>	
	<b>Lamp Settings</b>	<b>Lamp Mode</b>	<b>Normal/Economic/SmartEco/ LampSave</b>
		<b>Reset Lamp Timer</b>	
		<b>Equivalent Lamp Hour</b>	
	<b>Security Settings</b>	<b>Change Password</b>	
		<b>Change Security Settings</b>	<b>Power On Lock Web Control Lock</b>
	<b>Baud Rate</b>		<b>2400/4800/9600/14400/19200/ 38400/57600/115200</b>
	<b>Test Pattern</b>		<b>On/Off</b>
	<b>Closed Caption</b>	<b>Closed Caption Enable</b>	<b>On/Off</b>
		<b>Caption Version</b>	<b>CC1/CC2/CC3/CC4</b>
	<b>Standby Settings</b>	<b>Network</b>	<b>On/Off</b>
		<b>Monitor Out</b>	<b>On/Off</b>
		<b>Audio Pass Through</b>	<b>Off/Audio in/Audio L/R/HDMI</b>
<b>Network Settings</b>	<b>Wireless LAN</b>	<b>Status</b>	
		<b>SSID</b>	
		<b>IP Address</b>	
		<b>Connection Mode</b>	
		<b>Apply</b>	
	<b>Projection Log In Code</b>	<b>On/Off</b>	
	<b>Reset All Settings</b>		
<b>6. INFORMATION</b>	<b>Current System Status</b>	<ul style="list-style-type: none"> <li>• <b>Source</b></li> <li>• <b>Picture Mode</b></li> <li>• <b>Lamp Mode</b></li> <li>• <b>Resolution</b></li> <li>• <b>3D Format</b></li> <li>• <b>Color System</b></li> <li>• <b>Equivalent Lamp Hour</b></li> <li>• <b>Firmware Version</b></li> </ul>	



Note that the menu items are available when the projector detects at least one valid signal. If there is no equipment connected to the projector or no signal detected, limited menu items are accessible.





## Description of each menu

Function	Description
<b>I. DISPLAY menu</b>	<p><b>Wall Color</b></p> <p>Corrects the projected picture's color when the projection surface is not white. See <a href="#">"Using Wall Color" on page 28</a> for details.</p>
	<p><b>Aspect Ratio</b></p> <p>There are several options to set the image's aspect ratio depending on your input signal source. See <a href="#">"Selecting the aspect ratio" on page 26</a> for details.</p>
	<p><b>Keystone</b></p> <p>Corrects any keystone of the image. See <a href="#">"Correcting keystone" on page 20</a> for details.</p>
	<p><b>Position</b></p> <p>Displays the position adjustment page. To move the projected image, use the directional arrow keys. The values shown on the lower position of the page change with every key press you made until they reach their maximum or minimum.</p> <p> This function is only available when a PC signal (analog RGB) is selected.</p>
	<p><b>Phase</b></p> <p>Adjusts the clock phase to reduce image distortion.</p> <div style="text-align: right;">  </div> <p> This function is only available when a PC signal (analog RGB) is selected.</p>
	<p><b>H. Size</b></p> <p>Adjusts the horizontal width of the image.</p> <p> This function is only available when a PC signal (analog RGB) is selected.</p>
	<p><b>Digital Zoom</b></p> <p>Magnifies or reduces the projected image. See <a href="#">"Magnifying and searching for details" on page 25</a> for details.</p>



Function	Description
<p style="writing-mode: vertical-rl; transform: rotate(180deg);">I. DISPLAY menu</p> <p style="text-align: center; font-weight: bold; font-size: 1.2em;">3D</p>	<p>This projector features a 3D function which enables you to enjoy the 3D movies, videos, and sporting events in a more realistic way by presenting the depth of the images. You need to wear a pair of 3D glasses to view the 3D content.</p> <p><b>3D Mode</b></p> <p>The default setting is <b>Auto</b> and the projector automatically chooses an appropriate 3D format when detecting 3D content. If the projector cannot recognize the 3D format, press ◀/▶ to choose a 3D mode.</p> <p> When the <b>3D</b> function is on:</p> <ul style="list-style-type: none"> <li>• The brightness level of the projected image will decrease.</li> <li>• The <b>Picture Mode</b> cannot be adjusted.</li> </ul> <p><b>3D Sync Invert</b></p> <p>When you discover the inversion of the image depth, enable this function to correct the problem.</p> <p><b>Apply 3D Settings</b></p> <p>After the 3D settings are saved, you can decide if you would like to apply them by choosing a set of 3D settings that you have saved. Once applied, the projector will automatically play the incoming 3D content if it matches the 3D settings saved.</p> <p> Only the set(s) of 3D settings with memorized data is available.</p> <p><b>Save 3D Settings</b></p> <p>When you have successfully displayed the 3D content after making the appropriate adjustments, you can enable this function and choose a set of 3D settings to memorize current 3D settings.</p>
<p><b>Teaching Template</b></p>	<p>See <a href="#">"Using the teaching templates"</a> on page 35 for details.</p>

Function	Description
<b>2. PICTURE menu</b>	<b>Picture Mode</b> Pre-defined picture modes are provided so you can optimize your projector image set-up to suit your program type. See " <a href="#">Selecting a picture mode</a> " on page 28 for details.
	<b>Reference Mode</b> Selects a picture mode that best suits your need for the image quality and further fine-tune the image based on the selections listed on the same page below. See " <a href="#">Setting the User 1/User 2 mode</a> " on page 28 for details.
	<b>Brightness</b> Adjusts the brightness of the image. See " <a href="#">Adjusting Brightness</a> " on page 29 for details.
	<b>Contrast</b> Adjusts the degree of difference between dark and light in the image. See " <a href="#">Adjusting Contrast</a> " on page 29 for details.
	<b>Color</b> Adjusts the color saturation level -- the amount of each color in a video image. See " <a href="#">Adjusting Color</a> " on page 29 for details.  This function is only available when a Video, S-Video or Component Video signal is selected.
	<b>Tint</b> Adjusts the red and green color tones of the image. See " <a href="#">Adjusting Tint</a> " on page 29 for details.  This function is only available when a Video or S-Video signal is selected and the system format is NTSC.
	<b>Sharpness</b> Adjusts the image to make it look sharper or softer. See " <a href="#">Adjusting Sharpness</a> " on page 29 for details.  This function is only available when a Video, S-Video or Component Video signal is selected.
	<b>Brilliant Color</b> See " <a href="#">Adjusting Brilliant Color</a> " on page 29 for details.
	<b>Color Temperature</b> See " <a href="#">Selecting a Color Temperature</a> " on page 29 for details.

	Function	Description
2. PICTURE menu	<b>Color Temperature Fine Tuning</b>	See <a href="#">"Setting a preferred color temperature" on page 30</a> for details.
	<b>3D Color Management</b>	See <a href="#">"3D Color Management" on page 30</a> for details.
	<b>Reset Picture Settings</b>	See <a href="#">"Resetting current or all picture modes" on page 31</a> for details.
3. SOURCE	<b>Quick Auto Search</b>	See <a href="#">"Switching input signal" on page 24</a> for details.
	<b>Color Space Conversion</b>	See <a href="#">"Changing Color Space" on page 25</a> for details.
4. SYSTEM SETUP: Basic menu	<b>Presentation Timer</b>	Reminds the presenter to finish the presentation within a certain time frame. See <a href="#">"Setting the presentation timer" on page 31</a> for details.
	<b>Language</b>	Sets the language for the On-Screen Display (OSD) menus. See <a href="#">"Using the menus" on page 21</a> for details.
	<b>Projector Installation</b>	The projector can be installed on a ceiling or behind a screen, or with one or more mirrors. See <a href="#">"Choosing a location" on page 13</a> for details.
	<b>Menu Settings</b>	<p><b>Menu Display Time</b> Sets the length of time the OSD will remain active after your last key press.</p> <p><b>Menu Position</b> Sets the On-Screen Display (OSD) menu position.</p> <p><b>Reminder Message</b> Sets the reminder messages on or off.</p>

Function	Description
<b>4. SYSTEM SETUP: Basic menu</b>  <b>Operation Settings</b>	<p><b>Direct Power On</b> Allows the projector to turn on automatically once the power is fed through the power cord.</p> <p><b>Signal Power On</b> Sets whether to turn the projector directly on without pressing  <b>POWER</b> when the projector is in standby mode and the signal is fed through the VGA cable.</p> <p><b>Auto Power Off</b> Allows the projector to turn off automatically if no input signal is detected after a set period of time. See "<a href="#">Setting Auto Power Off</a>" on <a href="#">page 49</a> for details.</p> <p><b>Quick Cooling</b> Enables or disables the Quick Cooling function. Selecting <b>On</b> enables the function and projector cooling time will be shortened from a normal 90-second duration to approximately 15 seconds.</p> <p> This function is only available when <b>Instant Restart</b> is off.</p> <p><b>Auto Blank</b> See "<a href="#">Hiding the image</a>" on <a href="#">page 33</a> for details.</p> <p><b>Instant Restart</b> Selecting <b>On</b> enables you to restart the projector immediately within 90 seconds after turning it off.</p> <p><b>Blank Timer</b> Sets the image blank time when the Blank feature is activated, once elapsed the image will return to the screen. See "<a href="#">Hiding the image</a>" on <a href="#">page 33</a> for details.</p> <p><b>Sleep Timer</b> Sets the auto-shutdown timer.</p>
	<p><b>Remote Receiver</b> Allows you to enable all the remote receivers or one specific remote receiver on the projector.</p>
	<p><b>Panel Key Lock</b> Disables or enables all panel key functions except  <b>POWER</b> on the projector and keys on the remote control. See "<a href="#">Locking control keys</a>" on <a href="#">page 33</a> for details.</p>
	<p><b>Background Color</b> Sets the background color for the projector.</p>
	<p><b>Splash Screen</b> Allows you to select which logo screen will display during projector start-up.</p>

Function	Description
<b>5. SYSTEM SETUP: Advanced menu</b>	<p><b>High Altitude Mode</b></p> <p>A mode for operation in high altitude areas. See <a href="#">"Operating in a high altitude environment"</a> on page 33 for details.</p>
	<p><b>Audio Settings</b></p> <p>See <a href="#">"Adjusting the sound"</a> on page 34 for details.</p>
	<p><b>Lamp Settings</b></p> <p><b>Lamp Mode</b> See <a href="#">"Setting the Lamp Mode"</a> on page 49 for details.</p> <p><b>Reset Lamp Timer</b> See <a href="#">"Resetting the lamp timer"</a> on page 53 for details.</p> <p><b>Equivalent Lamp Hour</b> See <a href="#">"Getting to know the lamp hour"</a> on page 49 for details on how the total lamp hour is calculated.</p>
	<p><b>Security Settings</b></p> <p><b>Change Password</b> <b>Change Security Settings</b> <b>Power On Lock</b> See <a href="#">"Utilizing the password function"</a> on page 22 for details.</p> <p><b>Web Control Lock</b> See <a href="#">BenQ Network Projector Operation Guide</a> for details.</p>
	<p><b>Baud Rate</b></p> <p>Selects a baud rate that is identical with your computer's so that you can connect the projector using a suitable RS-232 cable and update or download the projector's firmware. This function is intended for qualified service personnel.</p>
	<p><b>Test Pattern</b></p> <p>See <a href="#">"Using the test pattern"</a> on page 34 for details.</p>
	<p><b>Closed Caption</b></p> <p><b>Closed Caption Enable</b> Activates the function by selecting <b>On</b> when the selected input signal carries closed captions.</p> <ul style="list-style-type: none"> <li>• Captions: An on-screen display of the dialogue, narration, and sound effects of TV programs and videos that are closed captioned (usually marked as "CC" in TV listings).</li> </ul> <p><b>Caption Version</b> Selects a preferred closed captioning mode. To view captions, select CC1, CC2, CC3, or CC4 (CC1 displays captions in the primary language in your area).</p>

Function	Description
<b>5. SYSTEM SETUP: Advanced menu</b>	<p><b>Standby Settings</b></p> <p><b>Network</b> Selecting <b>On</b> enables the function. The projector is able to provide the network function when it is in standby mode.</p> <p><b>Monitor Out</b> Selecting <b>On</b> enables the function. The projector can output a VGA signal when it is in standby mode and the <b>COMPUTER</b> jack is correctly connected to devices. See "<a href="#">Connection</a>" on page 16 for how to make the connection.</p> <p><b>Audio Pass Through</b> The projector can play sound when it is in standby mode and the corresponding jacks are correctly connected to devices. Press ◀/▶ to choose the source that you wish to use. See "<a href="#">Connection</a>" on page 16 for how to make the connection.</p> <p> Enabling this function slightly increases the standby power consumption.</p>
	<p><b>Network Settings</b></p> <p>See <a href="#">BenQ Network Projector Operation Guide</a> for details.</p>
	<p><b>Reset All Settings</b></p> <p>Returns all settings to the factory preset values.</p> <p> The following settings will still remain: <b>Keystone, User 1, User 2, Color Space Conversion, Language, Projector Installation, High Altitude Mode, Security Settings, Baud Rate and Network Settings.</b></p>
<b>6. INFORMATION menu</b>	<p><b>Current System Status</b></p> <p><b>Source</b> Shows the current signal source.</p> <p><b>Picture Mode</b> Shows the selected mode in the <b>PICTURE</b> menu.</p> <p><b>Lamp Mode</b> Shows the current lamp mode.</p> <p><b>Resolution</b> Shows the native resolution of the input signal.</p> <p><b>3D Format</b> Shows the current 3D mode.</p> <p><b>Color System</b> Shows the input system format.</p> <p><b>Equivalent Lamp Hour</b> Displays the number of hours the lamp has been used.</p> <p><b>Firmware Version</b> Shows the firmware version of your projector.</p>

# Maintenance

## Care of the projector

Your projector needs little maintenance. The only thing you need to do on a regular basis is to keep the lens and case clean.

Never remove any parts of the projector except the lamp. Contact your dealer if other parts need replacing.

### Cleaning the lens

Clean the lens whenever you notice dirt or dust on the surface. Please be sure to turn off the projector and let it cool down completely before cleaning the lens.

- Use a canister of compressed air to remove dust.
- If there is dirt or smears, use lens-cleaning paper or moisten a soft cloth with lens cleaner and gently wipe the lens surface.
- Never use any type of abrasive pad, alkaline/acid cleaner, scouring powder, or volatile solvent, such as alcohol, benzene, thinner or insecticide. Using such materials or maintaining prolonged contact with rubber or vinyl materials may result in damage to the projector surface and cabinet material.

### Cleaning the projector case

Before you clean the case, turn the projector off using the proper shutdown procedure as described in "[Shutting down the projector](#)" on [page 37](#) and unplug the power cord.

- To remove dirt or dust, wipe the case with a soft, lint-free cloth.
- To remove stubborn dirt or stains, moisten a soft cloth with water and a neutral pH detergent. Then wipe the case.

 Never use wax, alcohol, benzene, thinner or other chemical detergents. These can damage the case.

### Storing the projector

If you need to store the projector for an extended time, please follow the instructions below:

- Make sure the temperature and humidity of the storage area are within the recommended range for the projector. Please refer to "[Specifications](#)" on [page 56](#) or consult your dealer about the range.
- Retract the adjuster feet.
- Remove the battery from the remote control.
- Pack the projector in its original packing or equivalent.

### Transporting the projector

It is recommended that you ship the projector with its original packing or equivalent.



# Lamp information

## Getting to know the lamp hour

When the projector is in operation, the duration (in hours) of lamp usage is automatically calculated by the built-in timer.

To obtain the lamp hour information:

1. Press **MENU/EXIT** and then press ◀/▶ to highlight the **SYSTEM SETUP: Advanced** menu.
2. Press ▼ to highlight **Lamp Settings** and press **MODE/ENTER**. The **Lamp Settings** page appears.
3. You will see the **Equivalent Lamp Hour** information appearing on the menu.
4. To leave the menu, press **MENU/EXIT**.

You can also get the lamp hour information on the **INFORMATION** menu.

## Extending lamp life

The projection lamp is a consumable item that normally can last up to 3000-4000 hours with proper usage. To keep the lamp life as long as possible, you can do the following settings via the OSD menu.

- **Setting the Lamp Mode**

Setting the projector in **Economic**, **SmartEco** or **LampSave** mode extends the lamp operation life. To set **Economic**, **SmartEco** or **LampSave** mode, go into the **SYSTEM SETUP: Advanced > Lamp Settings > Lamp Mode** menu and press ◀/▶.

Lamp mode	Description
<b>Normal</b>	Provides full lamp brightness
<b>Economic</b>	Lowers brightness to extend the lamp life and decreases the fan noise
<b>SmartEco</b>	Adjusts the lamp power automatically depending on the content brightness level
<b>LampSave</b>	Adjusts the lamp power automatically and lowers the brightness to extend the lamp life

- **Setting Auto Power Off**

This function allows the projector to turn off automatically if no input signal is detected after a set period of time to prevent unnecessary waste of lamp life.

To set **Auto Power Off**, go into the **SYSTEM SETUP: Basic > Operation Settings > Auto Power Off** menu and press ◀/▶. If the preset time lengths are not suitable for your presentation, select **Disable**. The projector will not automatically shut down in a certain time period.

## Timing of replacing the lamp

When the **Lamp indicator** lights up red or a message appears suggesting it is time to replace the lamp, please install a new lamp or consult your dealer. An old lamp may cause a malfunction in the projector and in some instances the lamp may explode.

Go to <http://lamp.benq.com> for a replacement lamp.



The **LAMP indicator light** and **TEMPerature warning light** will light up if the lamp becomes too hot. Turn the power off and let the projector cool for 45 minutes. If the Lamp or Temp indicator still lights up after turning the power back on, please contact your dealer. See "**Indicators**" on page 54 for details.

The following Lamp warning displays will remind you to change the lamp.

Status	Message
<p>Install a new lamp for optimal performance. If the projector is normally run with <b>Economic</b> selected (See "<b>Getting to know the lamp hour</b>" on page 49), you may continue to operate the projector until the next hour lamp warning appears.</p> <p>Press <b>MODE/ENTER</b> to dismiss the message.</p>	
<p>It is strongly recommended that you replace the lamp at this age. The lamp is a consumable item. The lamp brightness diminishes with use. This is normal lamp behavior. You can replace the lamp whenever you notice that the brightness level has significantly diminished.</p> <p>Press <b>MODE/ENTER</b> to dismiss the message.</p>	
<p>The lamp <b>MUST</b> be replaced before the projector will operate normally.</p> <p>Press <b>MODE/ENTER</b> to dismiss the message.</p>	



"XXXX" shown in the above messages are numbers that vary depending on different models.

# Replacing the lamp



- To reduce the risk of electrical shock, always turn the projector off and disconnect the power cord before changing the lamp.
  - To reduce the risk of severe burns, allow the projector to cool for at least 45 minutes before replacing the lamp.
  - To reduce the risk of injuries to fingers and damage to internal components, use caution when removing lamp glass that has shattered into sharp pieces.
  - To reduce the risk of injuries to fingers and/or compromising image quality by touching the lens, do not touch the empty lamp compartment when the lamp is removed.
  - This lamp contains mercury. Consult your local hazardous waste regulations to dispose of this lamp in a proper manner.
  - To assure optimal performance from the projector, it is recommended that you purchase a qualified projector lamp for lamp replacement.
  - If lamp replacement is performed while the projector is suspended upside-down from the ceiling, make sure that no one is underneath the lamp socket to avoid any possible injury or damage to the human eyes caused by fractured lamp.
  - Ensure good ventilation when handling broken lamps. We recommend that you use respirators, safety glasses, goggles or face shield and wear protective clothing such as gloves.
1. Turn the power off and disconnect the projector from the power outlet. If the lamp is hot, avoid burns by waiting for approximately 45 minutes until the lamp has cooled.

- 
2. Loosen the screw(s) that secures the lamp cover on the side of the projector until the lamp cover loosens.

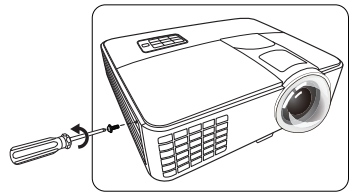

- 
3. Remove the lamp cover from the projector.



- Do not turn the power on with the lamp cover removed.
- Do not insert your fingers between the lamp and the projector. The sharp edges inside the projector may cause injuries.

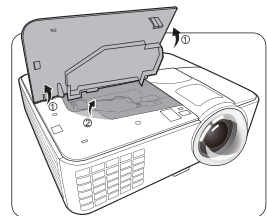

- 
4. Disconnect the lamp connector from the projector as illustrated.
  5. Loosen the screw that secures the lamp.
  6. Lift the handle so that it stands up.

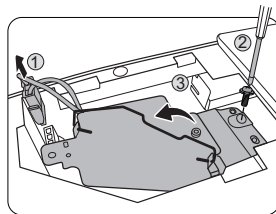

- 
7. Use the handle to slowly pull the lamp out of the projector.



- Pulling it too quickly may cause the lamp to break and scatter broken glass in the projector.
- Do not place the lamp in locations where water might splash on it, children can reach it, or near flammable materials.
- Do not insert your hands into the projector after the lamp is removed. If you touch the optical components inside, it could cause color unevenness and distortion of the projected images.

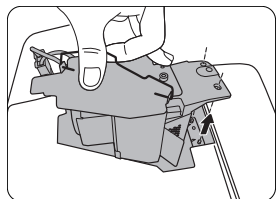

- 
8. As shown in the figure, lower the new lamp.

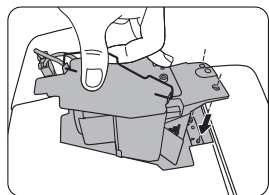

- 
9. Tighten the screw that secures the lamp.
  10. Ensure the handle is fully laid flat and locked in place.
  11. Reconnect the lamp connector.



- Loose screw may cause a bad connection, which could result in malfunction.
- Do not over tighten the screw.

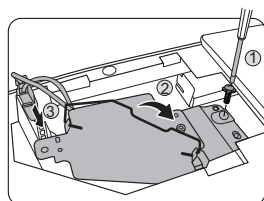

---

12. Replace the lamp cover on the projector.

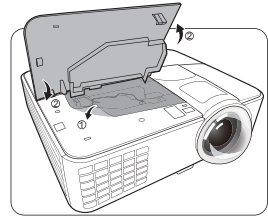

---

13. Tighten the screw(s) that secures the lamp cover.



- Loose screw may cause a bad connection, which could result in malfunction.
- Do not over tighten the screw.

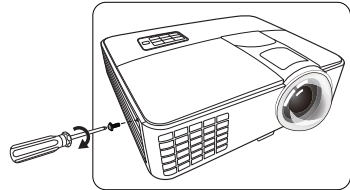

14. Connect the power and restart the projector.



Do not turn the power on with the lamp cover removed.



#### Resetting the lamp timer

15. After the startup logo, open the On-Screen Display (OSD) menu. Go to the **SYSTEM SETUP: Advanced > Lamp Settings** menu. Press **MODE/ENTER**. The **Lamp Settings** page appears. Highlight **Reset Lamp Timer**. A warning message appears asking if you want to reset the lamp timer. Highlight **Reset** and press **MODE/ENTER**. The lamp time will be reset to "0".



Do not reset if the lamp is not new or replaced as this could cause damage.

## Indicators

Light			Status & Description
POWER 	TEMP 	LAMP 	
<b>Power events</b>			
<b>Orange</b>	<b>Off</b>	<b>Off</b>	Stand-by mode
<b>Green Flashing</b>	<b>Off</b>	<b>Off</b>	Powering up
<b>Green</b>	<b>Off</b>	<b>Off</b>	Normal operation
<b>Orange Flashing</b>	<b>Off</b>	<b>Off</b>	Normal power-down cooling
<b>Red</b>	<b>Off</b>	<b>Off</b>	Download
<b>Green</b>	<b>Off</b>	<b>Red</b>	CW start fail
<b>Red Flashing</b>	<b>Off</b>	<b>Off</b>	Scaler shutdown fail (data abort)
<b>Red</b>	<b>Off</b>	<b>Red</b>	Scaler reset fail (video projector only)
<b>Green</b>	<b>Off</b>	<b>Off</b>	Burn-in ON
<b>Green</b>	<b>Green</b>	<b>Green</b>	Burn-in OFF
<b>Lamp events</b>			
<b>Off</b>	<b>Off</b>	<b>Red</b>	Lamp 1 error in normal operation
<b>Off</b>	<b>Off</b>	<b>Orange Flashing</b>	Lamp is not lit up
<b>Thermal events</b>			
<b>Red</b>	<b>Red</b>	<b>Off</b>	Fan 1 error (the actual fan speed is $\pm 25\%$ outside the desired speed)
<b>Red</b>	<b>Red Flashing</b>	<b>Off</b>	Fan 2 error (the actual fan speed is $\pm 25\%$ outside the desired speed)
<b>Green</b>	<b>Red</b>	<b>Off</b>	Temperature 1 error (over limited temperature)
<b>Green</b>	<b>Red Flashing</b>	<b>Off</b>	Thermal Sensor 1 open error
<b>Green</b>	<b>Green</b>	<b>Off</b>	Thermal Sensor 1 short error
<b>Green</b>	<b>Green Flashing</b>	<b>Off</b>	Thermal IC #1 I2C Connection error
<b>Green Flashing</b>	<b>Red</b>	<b>Off</b>	Temperature 2 error (over limited temperature)
<b>Green Flashing</b>	<b>Red Flashing</b>	<b>Off</b>	Thermal Sensor 2 open error
<b>Green Flashing</b>	<b>Green</b>	<b>Off</b>	Thermal Sensor 2 short error
<b>Green Flashing</b>	<b>Green Flashing</b>	<b>Off</b>	Thermal IC #2 I2C Connection error

# Troubleshooting

## ? The projector does not turn on.

Cause	Remedy
There is no power from the power cord.	Plug the power cord into the AC power jack on the projector, and plug the power cord into the power outlet. If the power outlet has a switch, make sure that it is switched on.
Attempting to turn the projector on again during the cooling process.	Wait until the cooling down process has completed.

## ? No picture

Cause	Remedy
The video source is not turned on or connected correctly.	Turn the video source on and check that the signal cable is connected correctly.
The projector is not correctly connected to the input signal device.	Check the connection.
The input signal has not been correctly selected.	Select the correct input signal with the <b>SOURCE</b> key on the projector or remote control.
The lens cover is still closed.	Open the lens cover.

## ? Blurred image

Cause	Remedy
The projection lens is not correctly focused.	Adjust the focus of the lens using the focus ring.
The projector and the screen are not aligned properly.	Adjust the projection angle and direction as well as the height of the projector if necessary.
The lens cover is still closed.	Open the lens cover.

## ? Remote control does not work

Cause	Remedy
The battery is out of power.	Replace the battery with new ones.
There is an obstacle between the remote control and the projector.	Remove the obstacle.
You are too far away from the projector.	Stand within 8 meters (26 feet) of the projector.

## ? The password is incorrect

Cause	Remedy
You do not remember the password.	Please see <a href="#">"Entering the password recall procedure" on page 23</a> for details.

# Specifications

## Projector specifications

 All specifications are subject to change without notice.

### Optical

#### Resolution

800 x 600 SVGA (MS619ST)  
1024 x 768 XGA (MX620ST)  
1280 x 800 WXGA (MW621ST)

#### Display system

1-CHIP DMD

#### Lens F/Number

F = 2.6 ~ 2.78, f = 10.2 ~ 12.24 mm

#### Lamp

190 W lamp

### Electrical

#### Power supply

AC100–240V, 2.8 A, 50-60 Hz (Automatic)

#### Power consumption

280 W (Max); < 0.5 W (Standby)

### Mechanical

#### Weight

2.6 Kg (5.73 lbs)

### Output terminals

#### RGB output

D-Sub 15-pin (female) x 1

#### Speaker

(Stereo) 10 watt x 1

#### Audio signal output

PC audio jack x 1

### Control

#### RS-232 serial control

9 pin x 1

#### IR receiver x 2

### Input terminals

#### Computer input

##### RGB input

D-Sub 15-pin (female) x 1

#### Video signal input

##### S-VIDEO

Mini DIN 4-pin port x 1

##### VIDEO

RCA jack x 1

#### SD/HDTV signal input

Analog - Component RCA jack x 3  
(through RGB input)

Digital - HDMI x 1

#### Audio signal input

##### Audio in

RCA audio jack (L/R) x 2

PC audio jack x 1

#### USB port

Mini-B x 1

Type A x 1

### Environmental Requirements

#### Operating temperature

0°C–40°C at sea level

#### Operating relative humidity

10%–90% (without condensation)

#### Operating altitude

0–1499 m at 0°C–35°C

1500–3000 m at 0°C–30°C (with

High Altitude Mode on)



# Dimensions

287.3 mm (W) x 114.4 mm (H) x 232.6 mm (D)

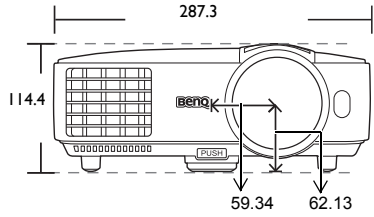
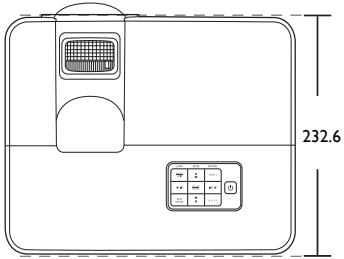

Unit: mm

# Ceiling mount installation

Ceiling Mount screw: M4  
(Max L = 25 mm; Min L = 20 mm)

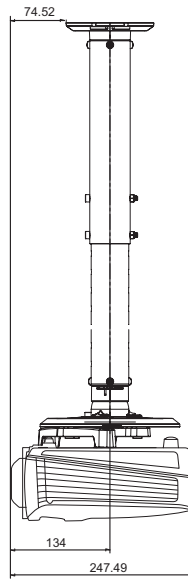
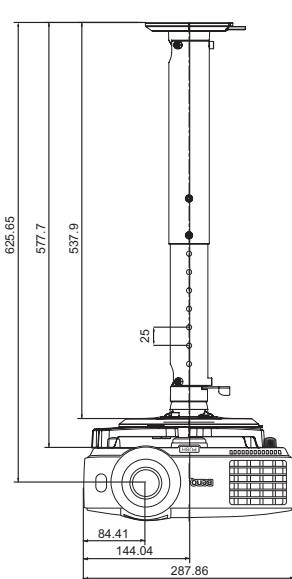
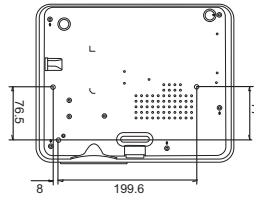
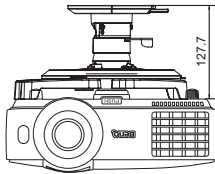

Unit: mm

# Timing chart

## Supported timing for PC input

Resolution	Mode	Vertical Frequency (Hz)	Horizontal Frequency (kHz)	Pixel Frequency (MHz)
640 x 480	VGA_60*	59.940	31.469	25.175
	VGA_72	72.809	37.861	31.500
	VGA_75	75.000	37.500	31.500
	VGA_85	85.008	43.269	36.000
720 x 400	720 x 400_70	70.087	31.469	28.3221
800 x 600	SVGA_56	56.250	35.156	36.000
	SVGA_60*	60.317	37.879	40.000
	SVGA_72	72.188	48.077	50.000
	SVGA_75	75.000	46.875	49.500
	SVGA_85	85.061	53.674	56.250
	SVGA_120** (Reduce Blanking)	119.854	77.425	83.000
1024 x 768	XGA_60*	60.004	48.363	65.000
	XGA_70	70.069	56.476	75.000
	XGA_75	75.029	60.023	78.750
	XGA_85	84.997	68.667	94.500
	XGA_120** (Reduce Blanking)	119.989	97.551	115.5
1152 x 864	1152 x 864_75	75	67.5	108
1024 x 576	BenQ Notebook_timing	60.0	35.820	46.966
1024 x 600	BenQ Notebook_timing	64.995	41.467	51.419
1280 x 720	1280 x 720_60*	60	45.000	74.250
1280 x 768	1280 x 768_60*	59.870	47.776	79.5
1280 x 800	WXGA_60*	59.810	49.702	83.500
	WXGA_75	74.934	62.795	106.500
	WXGA_85	84.880	71.554	122.500
	WXGA_120** (Reduce Blanking)	119.909	101.563	146.25
1280 x 1024	SXGA_60***	60.020	63.981	108.000
	SXGA_75	75.025	79.976	135.000
	SXGA_85	85.024	91.146	157.500
1280 x 960	1280 x 960_60***	60.000	60.000	108.000
	1280 x 960_85	85.002	85.938	148.500
1360 x 768	1360 x 768_60***	60.015	47.712	85.5
1440 x 900	WXGA+_60***	59.887	55.935	106.500
1400 x 1050	SXGA+_60***	59.978	65.317	121.750
1600 x 1200	UXGA***	60.000	75.000	162.000
1680 x 1050	1680x1050_60***	59.954	65.290	146.25
640 x 480@67Hz	MAC13	66.667	35.000	30.240
832 x 624@75Hz	MAC16	74.546	49.722	57.280
1024 x 768@75Hz	MAC19	75.020	60.241	80.000
1152 x 870@75Hz	MAC21	75.060	68.680	100.000

 \*Supported timing for 3D signal in **Frame Sequential, Top Bottom** and **Side by Side** formats.

\*\*Supported timing for 3D signal in **Frame Sequential** format.

\*\*\*Supported timing for 3D signal in **Top Bottom** and **Side by Side** formats.

- The timings showing above may not be supported due to EDID file and VGA graphic card limitations. It is possible that some timings cannot be chosen.

## Supported timing for HDMI (HDCP) input

Resolution	Mode	Vertical Frequency (Hz)	Horizontal Frequency (kHz)	Pixel Frequency (MHz)
640 x 480	VGA_60*	59.940	31.469	25.175
	VGA_72	72.809	37.861	31.500
	VGA_75	75.000	37.500	31.500
	VGA_85	85.008	43.269	36.000
720 x 400	720 x 400_70	70.087	31.469	28.3221
800 x 600	SVGA_60*	60.317	37.879	40.000
	SVGA_72	72.188	48.077	50.000
	SVGA_75	75.000	46.875	49.500
	SVGA_85	85.061	53.674	56.250
	SVGA_120** (Reduce Blanking)	119.854	77.425	83.000
1024 x 768	XGA_60*	60.004	48.363	65.000
	XGA_70	70.069	56.476	75.000
	XGA_75	75.029	60.023	78.750
	XGA_85	84.997	68.667	94.500
	XGA_120** (Reduce Blanking)	119.989	97.551	115.5
1152 x 864	1152 x 864_75	75	67.5	108
1024 x 576@60Hz	BenQ Notebook Timing	60.00	35.820	46.996
1024 x 600@65Hz	BenQ Notebook Timing	64.995	41.467	51.419
1280 x 720	1280 x 720_60*	60	45.000	74.250
1280 x 768	1280 x 768_60*	59.870	47.776	79.5
1280 x 800	WXGA_60*	59.810	49.702	83.500
	WXGA_75	74.934	62.795	106.500
	WXGA_85	84.880	71.554	122.500
	WXGA_120** (Reduce Blanking)	119.909	101.563	146.25
1280 x 1024	SXGA_60***	60.020	63.981	108.000
	SXGA_75	75.025	79.976	135.000
	SXGA_85	85.024	91.146	157.500
1280 x 960	1280 x 960_60***	60.000	60.000	108
	1280 x 960_85	85.002	85.938	148.500
1360 x 768	1360 x 768_60***	60.015	47.712	85.500
1440 x 900	WXGA+ 60***	59.887	55.935	106.500
1400 x 1050	SXGA+ 60***	59.978	65.317	121.750
1600 x 1200	UXGA***	60.000	75.000	162.000
1680 x 1050	1680 x 1050_60***	59.954	65.290	146.250
640 x 480@67Hz	MAC13	66.667	35.000	30.240
832 x 624@75Hz	MAC16	74.546	49.722	57.280
1024 x 768@75Hz	MAC19	75.020	60.241	80.000
1152 x 870@75Hz	MAC21	75.06	68.68	100.00



\*Supported timing for 3D signal in **Frame Sequential**, **Top Bottom** and **Side by Side** formats.

\*\*Supported timing for 3D signal in **Frame Sequential** format.

\*\*\*Supported timing for 3D signal in **Top Bottom** and **Side by Side** formats.

- The timings showing above may not be supported due to EDID file and VGA graphic card limitations. It is possible that some timings cannot be chosen.

Timing	Resolution	Vertical Frequency (Hz)	Horizontal Frequency (kHz)	Pixel Frequency (MHz)	Remark
480i*	720 x 480	59.94	15.73	27	HDMI only
480p*	720 x 480	59.94	31.47	27	HDMI only
576i	720 x 576	50	15.63	27	HDMI/DVI
576p	720 x 576	50	31.25	27	HDMI/DVI
720/50p**	1280 x 720	50	37.5	74.25	HDMI/DVI
720/60p***	1280 x 720	60	45.00	74.25	HDMI/DVI
1080/50i****	1920 x 1080	50	28.13	74.25	HDMI/DVI
1080/60i****	1920 x 1080	60	33.75	74.25	HDMI/DVI
1080/24P**	1920 x 1080	24	27	74.25	HDMI/DVI
1080/25P	1920 x 1080	25	28.13	74.25	HDMI/DVI
1080/30P	1920 x 1080	30	33.75	74.25	HDMI/DVI
1080/50P*****	1920 x 1080	50	56.25	148.5	HDMI/DVI
1080/60P*****	1920 x 1080	60	67.5	148.5	HDMI/DVI

\*Supported timing for 3D signal in **Frame Sequential** format.

\*\*Supported timing for 3D signal in **Frame Packing, Top Bottom** and **Side by Side** formats.

\*\*\*Supported timing for 3D signal in **Frame Sequential, Frame Packing, Top Bottom** and **Side by Side** formats.

\*\*\*\*Supported timing for 3D signal in **Side by Side** format.

\*\*\*\*\*Supported timing for 3D signal in **Top Bottom** format.

## Supported timing for Component-YPbPr input

Timing	Resolution	Vertical Frequency (Hz)	Horizontal Frequency (kHz)	Pixel Frequency (MHz)
480i*	720 x 480	59.94	15.73	13.5
480p*	720 x 480	59.94	31.47	27
576i	720 x 576	50	15.63	13.5
576p	720 x 576	50	31.25	27
720/50p	1280 x 720	50	37.5	74.25
720/60p*	1280 x 720	60	45.00	74.25
1080/50i	1920 x 1080	50	28.13	74.25
1080/60i	1920 x 1080	60	33.75	74.25
1080/24P	1920 x 1080	24	27	74.25
1080/25P	1920 x 1080	25	28.13	74.25
1080/30P	1920 x 1080	30	33.75	74.25
1080/50P	1920 x 1080	50	56.25	148.5
1080/60P	1920 x 1080	60	67.5	148.5

\*Supported timing for 3D signal in **Frame Sequential** format.

• Displaying a 1080i(1125i)@60Hz or 1080i(1125i)@50Hz signal may result in slight image vibration.

## Supported timing for Video and S-Video inputs

Video mode	Horizontal Frequency (kHz)	Vertical Frequency (Hz)	Color sub-carrier Frequency (MHz)
NTSC*	15.73	60	3.58
PAL	15.63	50	4.43
SECAM	15.63	50	4.25 or 4.41
PAL-M	15.73	60	3.58
PAL-N	15.63	50	3.58
PAL-60	15.73	60	4.43
NTSC4.43	15.73	60	4.43

 \*Supported timing for 3D signal in **Frame Sequential** format.

# Warranty and Copyright information

## Limited warranty

BenQ warrants this product against any defects in material and workmanship, under normal usage and storage.

Proof of purchase date will be required with any warranty claim. In the event this product is found to be defective within the warranty period, BenQ's only obligation and your exclusive remedy shall be replacement of any defective parts (labor included). To obtain warranty service, immediately notify the dealer from which you purchased the product of any defects.

Important: The above warranty shall be void if the customer fails to operate the product in accordance with BenQ's written instructions, especially the ambient humidity must be in-between 10% and 90%, temperature in-between 0°C and 35°C, altitude lower than 4920 feet, and avoiding to operate the projector in a dusty environment. This warranty gives you specific legal rights, and you may have other rights which vary from country to country.

For other information, please visit [www.BenQ.com](http://www.BenQ.com).

## Copyright

Copyright 2013 by BenQ Corporation. All rights reserved. No part of this publication may be reproduced, transmitted, transcribed, stored in a retrieval system or translated into any language or computer language, in any form or by any means, electronic, mechanical, magnetic, optical, chemical, manual or otherwise, without the prior written permission of BenQ Corporation.

## Disclaimer

BenQ Corporation makes no representations or warranties, either expressed or implied, with respect to the contents hereof and specifically disclaims any warranties, merchantability or fitness for any particular purpose. Further, BenQ Corporation reserves the right to revise this publication and to make changes from time to time in the contents hereof without obligation to notify any person of such revision or changes.

\*DLP, Digital Micromirror Device and DMD are trademarks of Texas Instruments. Others are copyrights of their respective companies or organizations.

## Patents

This BenQ projector is covered by the following patents:

U.S. patents 6,837,608; 7,275,834; 7,181,318. TW patents 202690; 205470; I228635; I259932.

China patents ( 亏坟吴晰轧剩 ) ZL01143168.7; ZL03119907.0; ZL200510051609.2