

Gain and Attenuation Volume Controller IC

One Set of Stereo Input, Low voltage

Gain and Attenuation 15~-79dB, Good PSRR

FEATURES

- Operation range: 2.7V~6.5V
- Low power consumption
- Gain/Attenuation: 15dB to -79dB at 1dB/step
- Good PSRR and low pop noise
- Housed in 10 pin MSOP package
- I²C interface

APPLICATIONS

- Multimedia system
- Hi-Fi audio system
- MP3, PDA

DESCRIPTION

The MS6260 is the stereo audio volume controller IC. It uses CMOS technology specially for the low voltage application with low noise, rail-to-rail output. The MS6260 provide an I²C control interface with gain / attenuation range of 15dB to -79dB, 1dB/step. The excellent power supply ripple reject is a good for audio system. The initial condition is set to be maximum attenuation -79dB and mute on mode when power on.

BLOCK DIAGRAM

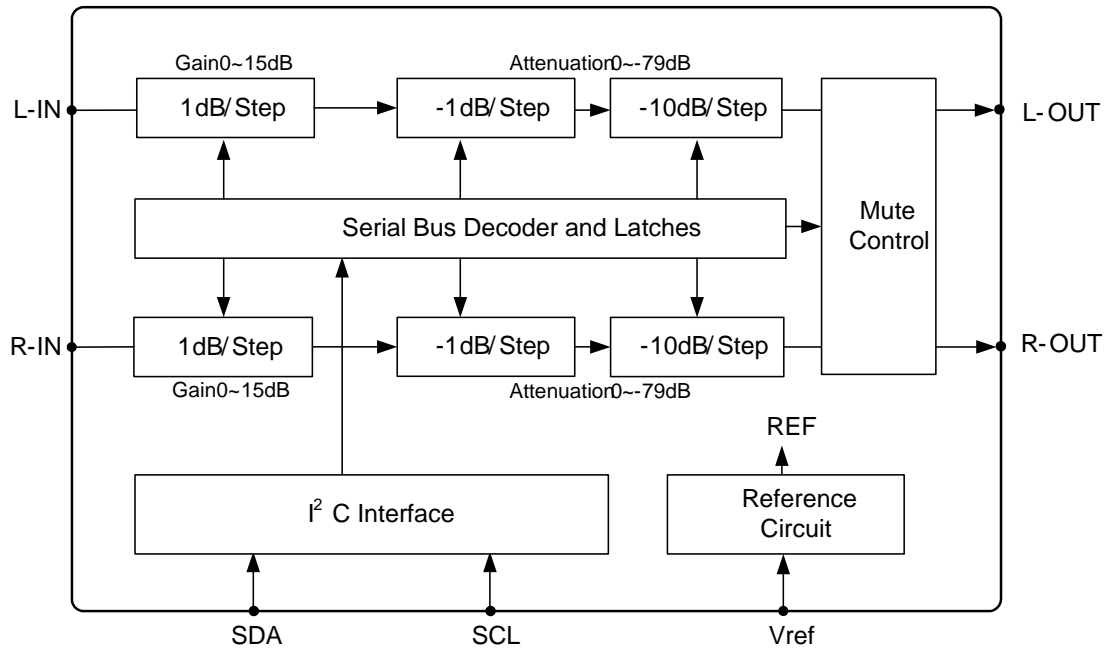

PIN CONFIGURATION

Symbol	Pin	Description
A.O.	1	Address option *
L-IN	2	Left channel input
L-OUT	3	Left channel output
V _{SS}	4	Ground
SDA	5	I ² C data input
SCL	6	I ² C clock input
V _{DD}	7	Positive supply voltage
R-OUT	8	Right channel output
R-IN	9	Right channel input
V _{REF}	10	Reference voltage = 1/2V _{DD}

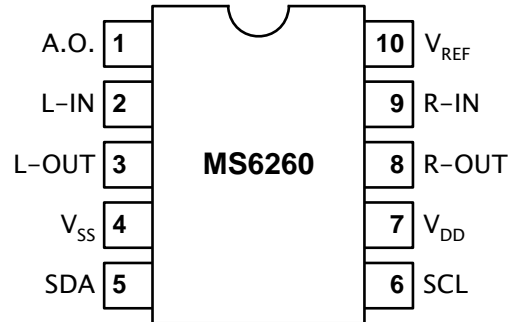

- Note:
1. Pin 1 is set to Lo or open , the address code is 88H (10001000B).
 2. Pin 1 is set to Hi , the address code is 8CH (10001100B).
 3. The V_{REF} connects a capacitor to V_{SS}.

ORDERING INFORMATION

Package	Part number	Packaging Marking	Transport Media
10-Pin MSOP (lead free)	MS6260MGTR	6260G	3.5k Units Tape and Reel
10-Pin MSOP (lead free)	MS6260MGU	6260G	80 Units Tube

ABSOLUTE MAXIMUM RATINGS

Symbol	Parameter	Rating	Unit
V _{DD}	Supply Voltage	6.5	V
V _{ESD}	Electrostatic Handling	-3000 to 3000	V
T _{STG}	Storage Temperature Range	-65 to 150	°C
T _A	Operating Ambient Temperature Range	-40 to 85	°C
T _J	Maximum Junction Temperature	150	°C
T _S	Soldering Temperature, 10 seconds	260	°C
R _{THJA}	Thermal Resistance from Junction to Ambient in Free Air MSOP10	235	°C/W

OPERATING RATINGS

Symbol	Parameter	Min	Typ	Max	Unit
V _{DD}	Supply Voltage	2.7	-	6.5	V

5V ELECTRICAL CHARACTERISTICS

($V_{DD}=5.0V$, $V_{SS}=0V$, Attenuation=0dB, Gain=0dB, $f=1kHz$, $V_O=0dBV$, V_{REF} Cap=10uF; unless otherwise specified)

Symbol	Parameter	Conditions	Min	Typ	Max	Unit
DC Characteristics						
I_Q	Quiescent current		-	3.8	4.2	mA
A_{GA}	Gain/Attenuation	Max gain	-	15	-	dB
		Max attenuation	-	-79	-	dB
A_{STEP}	Gain/Attenuation step		-	1	-	dB
E_{GA}	Gain/Attenuation step error		-	0.3	-	dB
E_{IGA}	Interchannel gin/attenuation error		-	0.3	-	dB
CS	Channel separation		95	105	-	dB
PSRR	Power supply rejection ratio	Vripple = -20dBV, 100Hz	-	53	-	dB
MUTE	Mute Attenuation	$V_{in}=0dBV$	-	85	-	dB
R_{in}	Input Impedance		18	20	-	k Ω
R_{out}	Output Impedance		-	50	100	Ω
AC Characteristics						
V_o	Maximum output voltage swing	(THD+N)/S < 0.1%	-	4.8	-	V _{pp}
THD+N	Total harmonic distortion plus noise		-	-69	-64	dB
S/N	Signal-to-noise ratio	$V_O=4.5V_{pp}$	95	100	-	dB
Bus Characteristics						
V_{IH}	Bus high input level		-	-	$0.7V_{DD}$	V
V_{IL}	Bus low input level		$0.3V_{DD}$	-	-	V

3.3V ELECTRICAL CHARACTERISTICS

($V_{DD}=3.3V$, $V_{SS}=0V$, Attenuation=0dB, Gain=0dB, $f=1kHz$, $V_O=-3dBV$, V_{REF} Cap=10uF; unless otherwise specified)

Symbol	Parameter	Conditions	Min	Typ	Max	Unit
DC Characteristics						
I_Q	Quiescent current		-	3.7	4.1	mA
CS	Channel separation		90	100	-	dB
PSRR	Power supply rejection ratio	Vripple = -20dBV, 100Hz	-	52	-	dB
MUTE	Mute Attenuation	$V_{in}=-3dBV$	-	80	-	dB
AC Characteristics						
V_o	Maximum output voltage swing	(THD+N)/S < 0.1%	-	3	-	V _{pp}
THD+N	Total harmonic distortion plus noise		-	-69	-64	dB
S/N	Signal-to-noise ratio		85	90	-	dB

2.7V ELECTRICAL CHARACTERISTICS

($V_{DD}=2.7V$, $V_{SS}=0V$, Attenuation=0dB, Gain=0dB, $f=1kHz$, $V_O=-3dBV$, V_{REF} Cap=10uF; unless otherwise specified)

Symbol	Parameter	Conditions	Min	Typ	Max	Unit
DC Characteristics						
I_Q	Quiescent current		-	3.2	3.6	mA
CS	Channel separation		90	100	-	dB
PSRR	Power supply rejection ratio	Vripple = -20dBV, 100Hz	-	50	-	dB
MUTE	Mute Attenuation	Vin=-3dBV	-	80	-	dB
AC Characteristics						
V_o	Maximum output voltage swing	(THD+N)/S < 0.3%	-	2	-	Vpp
THD+N	Total harmonic distortion plus noise		-	-69	-64	dB
S/N	Signal-to-noise ratio		85	90	-	dB

TYPICAL PERFORMANCE CHARACTERISTICS

($T_a=25^\circ C$, $R_L=10k\Omega$, V_{REF} Cap=10uF; unless otherwise specified)

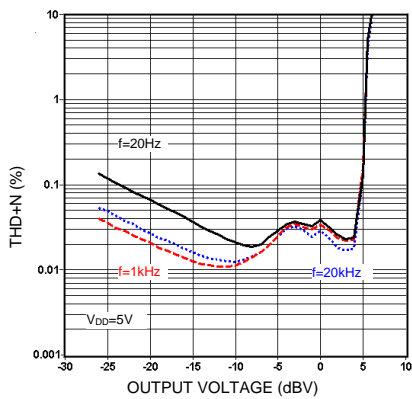

THD+N vs. output voltage

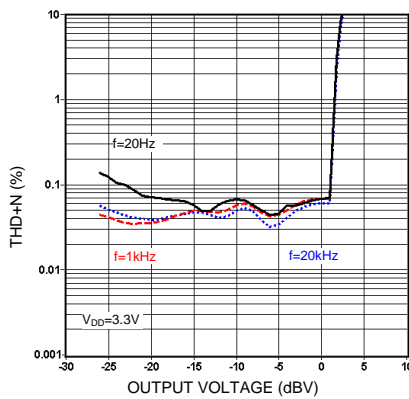

THD+N vs. output voltage

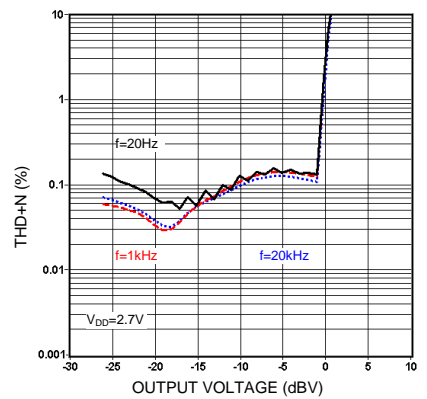

THD+N vs. output voltage

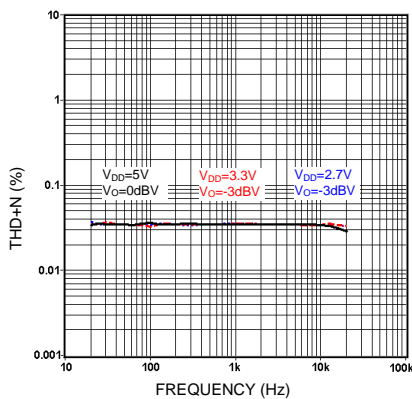

THD+N vs. frequency

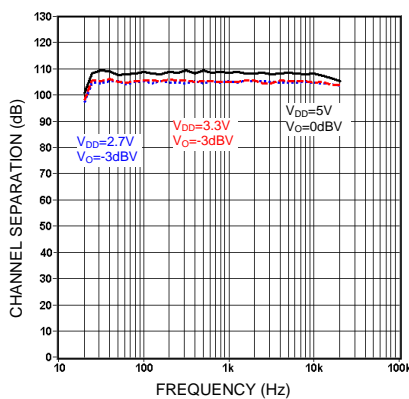

Channel separation vs. frequency

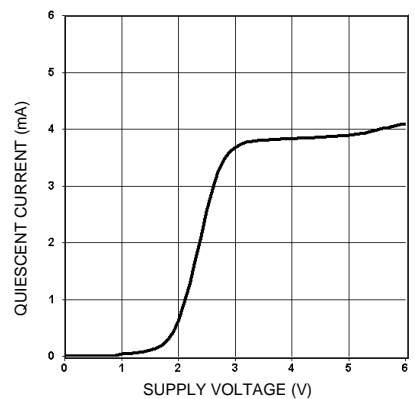

Quiescent current vs. supply voltage

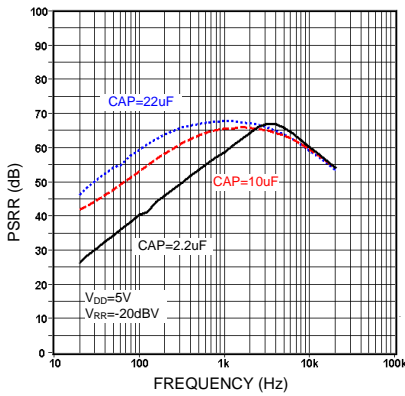

PSRR vs. frequency

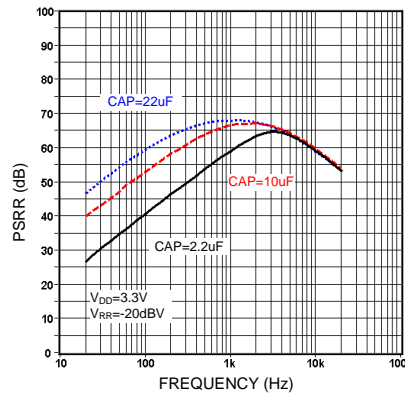

PSRR vs. frequency

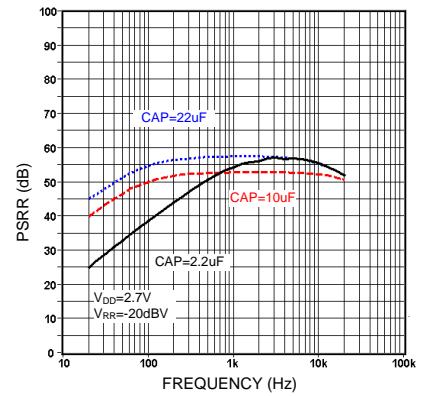

PSRR vs. frequency

I²C BUS DESCRIPTION

Start and stop conditions

A start condition is activated when the SCL is set to HIGH and SDA shifts from HIGH to LOW state. The stop condition is activated when SCL is set to HIGH and SDA shifts from LOW to HIGH state. Please refer to the timing diagram below.

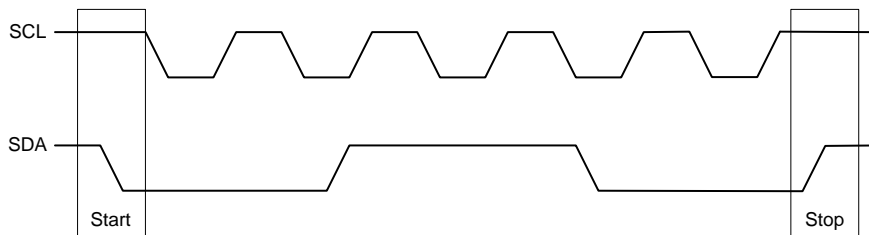

SCL : Serial Clock Line, SDA : Serial Data Line

Data validity

A data on the SDA line is considered valid and stable only when the SCL signal is in HIGH state. The HIGH and LOW states of the SDA line can only change when the SCL signal is LOW. Please refer to the figure below.

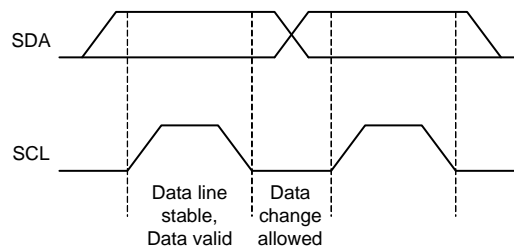

Byte format

Every byte transmitted to the SDA line consists of 8 bits. Each byte must be followed by an acknowledge bit. The MSB is transmitted first.

Acknowledge

During the Acknowledge clock pulse, the master (up) put a resistive HIGH level on the SDA line. The peripheral (audio processor) that acknowledges has to pull-down (LOW) the SDA line during the Acknowledge clock pulse so that the SDA line is in a stable LOW state during this clock pulse. Please refer to the diagram below.

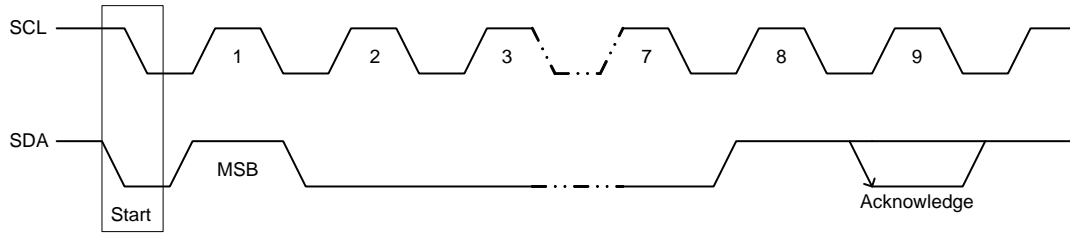

The audio processor that has been addressed has to generate an Acknowledge after receiving each byte, otherwise, the SDA line will remain at the HIGH level during the ninth (9th) clock pulse. In this case, the master transmitter can generate the STOP information in order to abort the transfer.

Timing of SDA and SCL bus lines

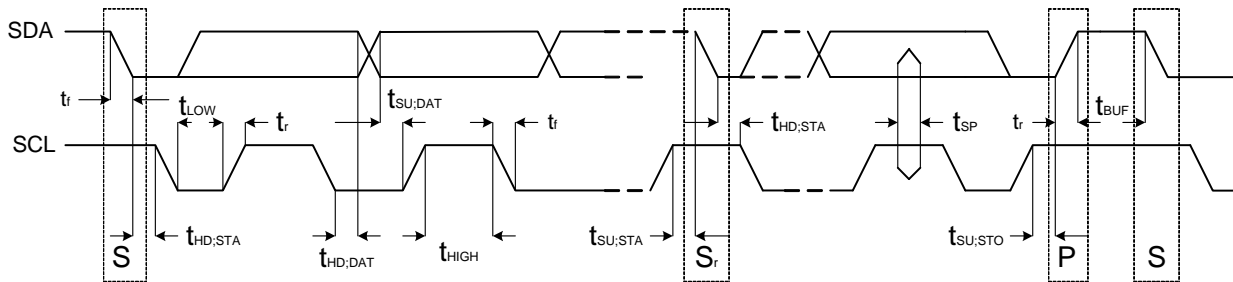

Standard mode

Symbol	Parameter	Min	Max	Unit
f_{SCL}	SCL clock frequency	0	100	kHz
$t_{HD:STA}$	Hold time (repeated) START condition. After this period, the first clock pulse is generated	4.0	-	us
t_{LOW}	LOW period of the SCL clock	4.7	-	us
t_{HIGH}	HIGH period of the SCL clock	4.0	-	us
$t_{SU:STA}$	Set-up time for a repeated START condition	4.7	-	us
$t_{HD:DAT}$	Data hold time: For I ² C-bus devices	0	3.45	us
$t_{SU:DAT}$	Data-set-up time	250	-	ns
t_r	Rise time of both SDA and SCL signals	-	1000	ns
t_f	Fall time of both SDA and SCL signals	-	300	ns
$t_{SU:STO}$	Set-up time for STOP condition	4.0	-	us
t_{BUF}	Bus free time between a STOP and START condition	4.7	-	us
C_b	Capacitive load for each bus line	-	400	pF
V_{nL}	Noise margin at the LOW level for each connected device (including hysteresis)	$0.1V_{DD}$	-	V
V_{nH}	Noise margin at the HIGH level for each connected device (including hysteresis)	$0.2V_{DD}$	-	V

BUS INTERFACE

Data are transmitted to and from the MCU to the MS6260 via the SDA and SCL. The SDA and SCL make up the BUS interface. It should be noted that pull-up resistors must be connected to the positive supply voltage.

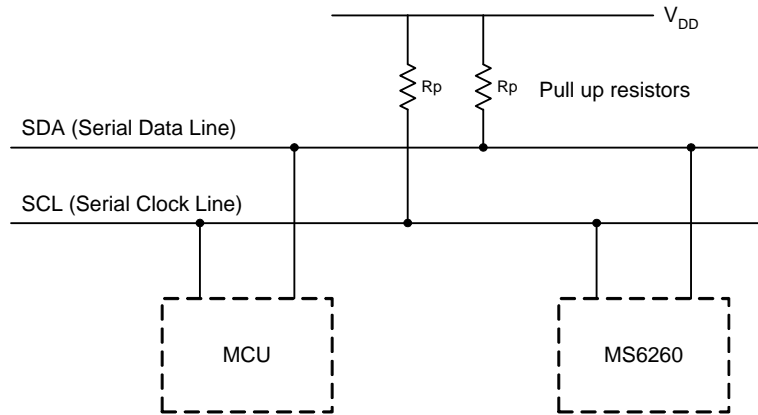

Interface protocol

The format consists of the following

- A START condition
- A chip address byte including the MS6260 address. (7bits)
- The 8th bit of the byte must be “0”.(write=0, read=1)
- The MS6260 must always acknowledge the end of each transmitted byte.
- A data sequence (N-bytes + Acknowledge)
- A STOP condition

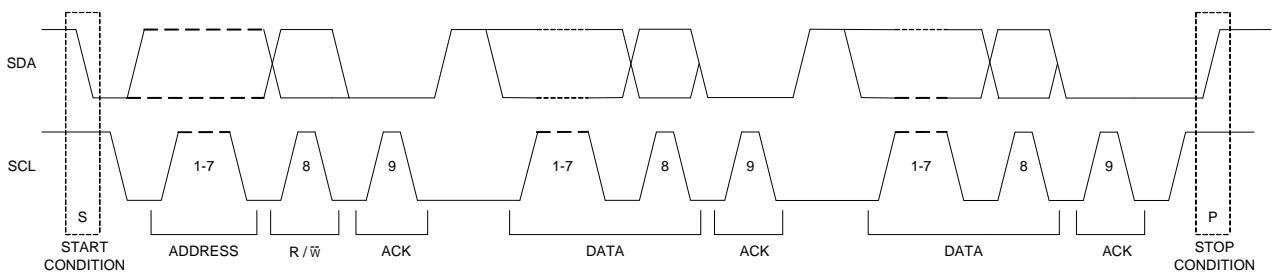

Protocol Address

Pin1(A.O.) = Low or Open

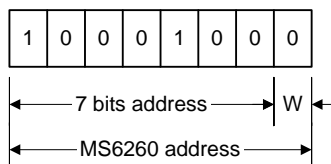

Pin1(A.O.) = High

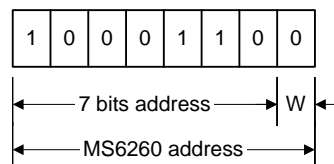

Data bytes description

Function bits								
MSB							LSB	Function
1	1	1	1	1	1	1	1	Function off (-79dB)
1	1	0	1	A3	A2	A1	A0	2-channel, -1dB/step
1	1	1	0	0	B2	B1	B0	2-channel, -10dB/step
1	0	1	0	A3	A2	A1	A0	Left channel, -1dB/step
1	0	1	1	0	B2	B1	B0	Left channel, -10dB/step
0	0	1	0	A3	A2	A1	A0	Right channel, -1dB/step
0	0	1	1	0	B2	B1	B0	Right channel, -10dB/step
1	1	0	0	C3	C2	C1	C0	2-channel, +1dB/step
0	1	1	0	C3	C2	C1	C0	Left channel, +1dB/step
0	1	0	1	C3	C2	C1	C0	Right channel, +1dB/step
0	1	1	1	0	0	0	1	Power off preparation (pop noise free)
				1	0	0	1	2-channel, mute On
				1	0	0	0	2-channel, mute Off

Gain / Attenuation bits						
A3	A2	A1	A0	Gain / Attenuation value (dB)		
-	B2	B1	B0	A	B	C
C3	C2	C1	C0			
0	0	0	0	0	0	0
0	0	0	1	-1	-10	+1
0	0	1	0	-2	-20	+2
0	0	1	1	-3	-30	+3
0	1	0	0	-4	-40	+4
0	1	0	1	-5	-50	+5
0	1	1	0	-6	-60	+6
0	1	1	1	-7	-70	+7
1	0	0	0	-8	-	+8
1	0	0	1	-9	-	+9
1	0	1	0	-	-	+10
1	0	1	1	-	-	+11
1	1	0	0	-	-	+12
1	1	0	1	-	-	+13
1	1	1	0	-	-	+14
1	1	1	1	-	-	+15

1. Where Ax=-1dB/step, Bx=-10dB/step, Cx=+1dB/step
2. The function of power off preparation is to prevent pop noise when power off.
3. The initial condition is set to be maximum attenuation -79dB and mute on mode when power on.

Example

Mute off

The initial condition is -79dB and mute on when power on. The first command must disable the mute function.

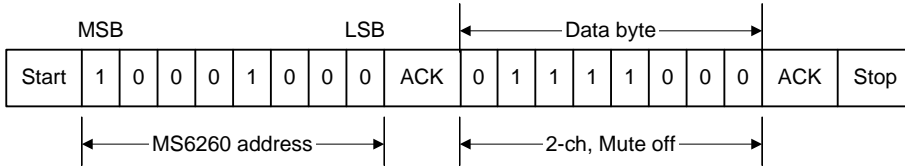

Set gain of 2 channel at 0dB

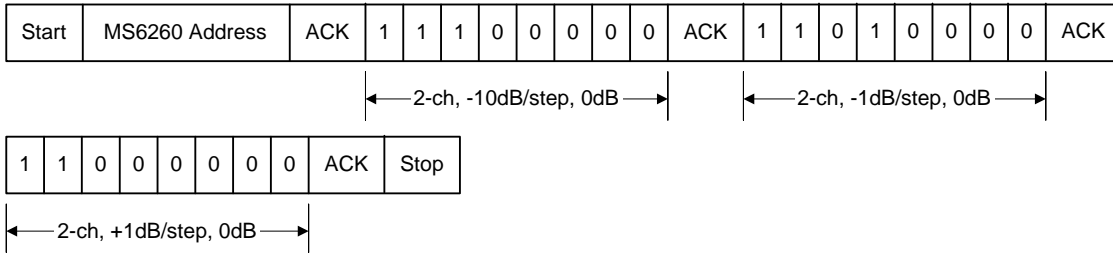

Set gain of 2 channel at 6dB

The value of attenuation must be set zero when the volume from attenuation to gain.

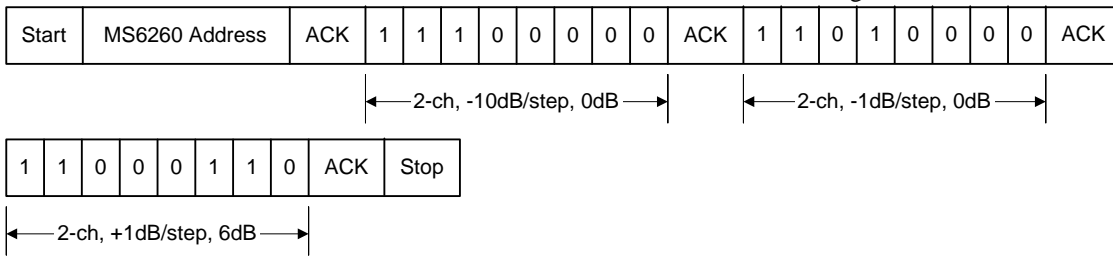

Set gain of 2 channel at -3dB

The value of gain must be set zero when the volume from gain to attenuation.

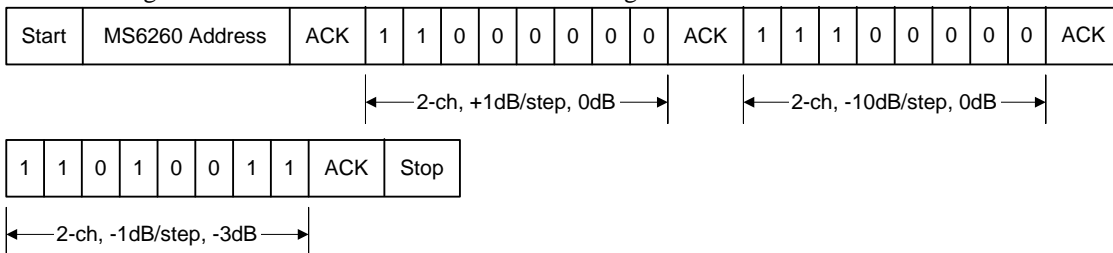

Set attenuation of left channel at -33dB

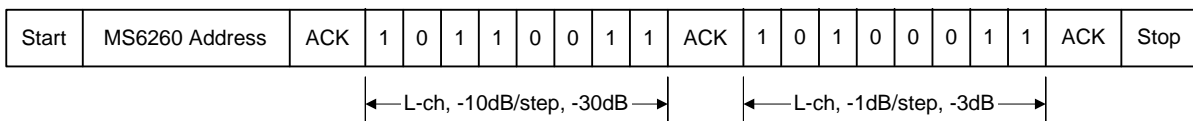

APPLICATION INFORMATION

Basic application example

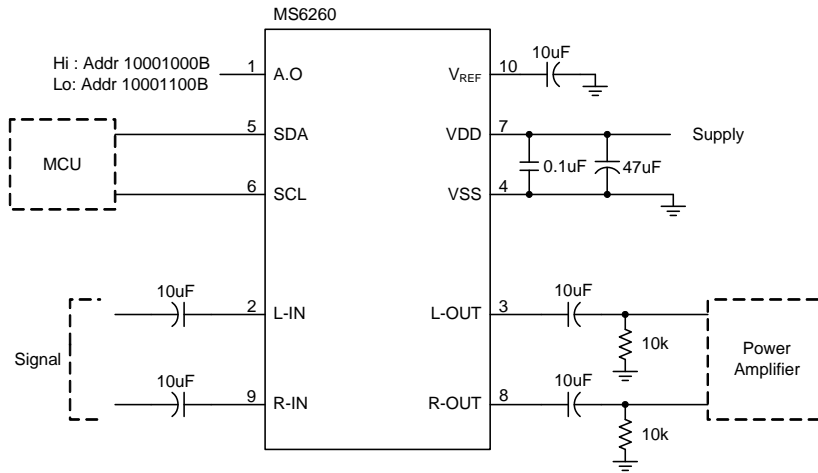

Basic application flow chart

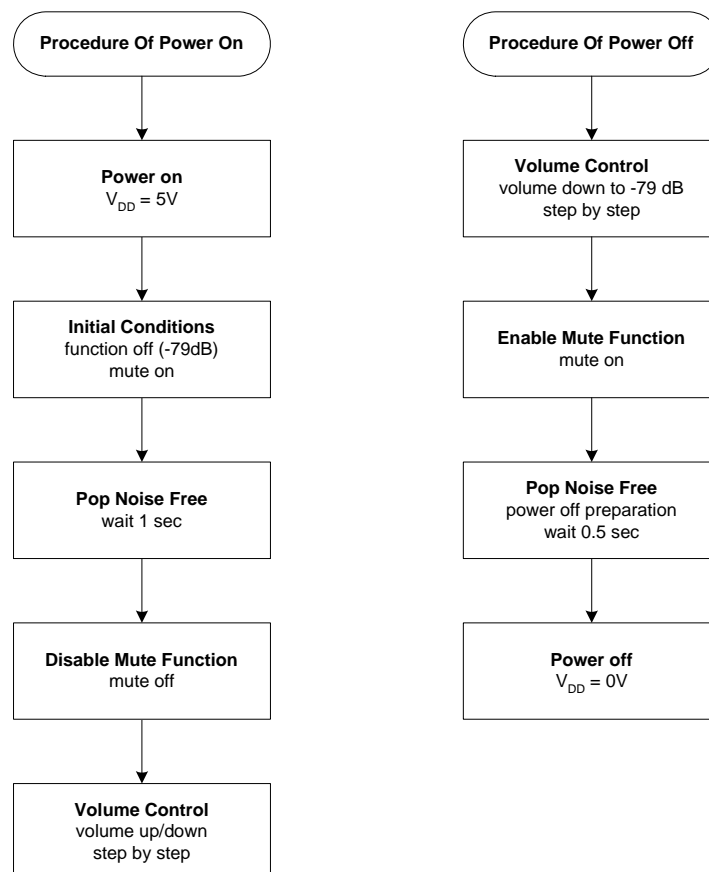

1. The initial condition is -79dB and mute on when power up.
2. In order to prevent pop noise when power on, please wait 1 sec to transmit I²C command.

EXTERNAL DIMENSIONS

MSOP10 package

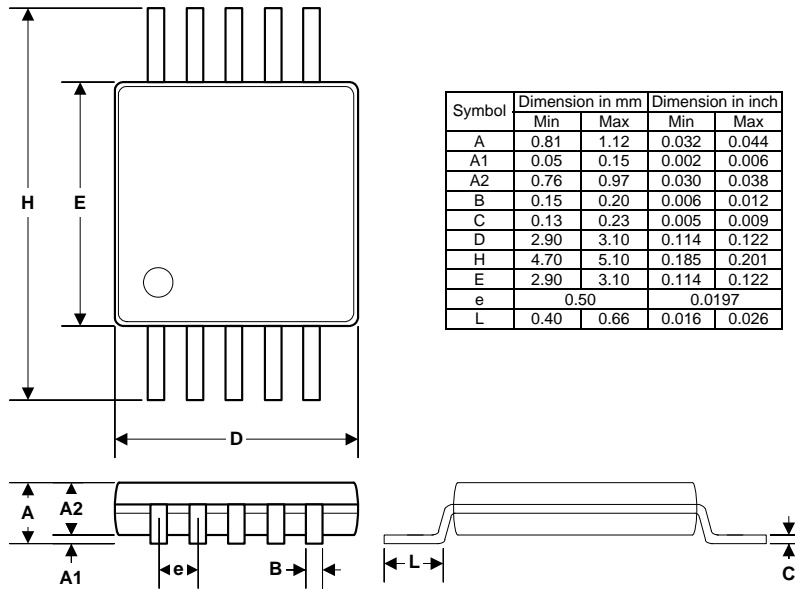

TAPE AND REEL (Unit : mm)

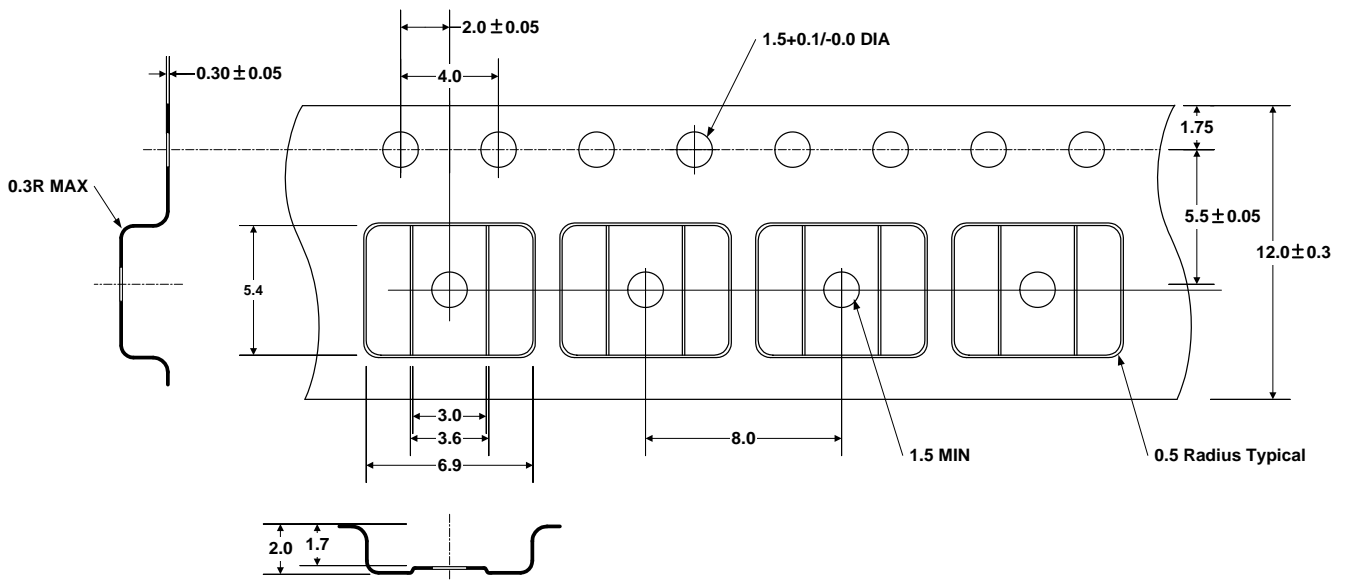

DEMO BOARD

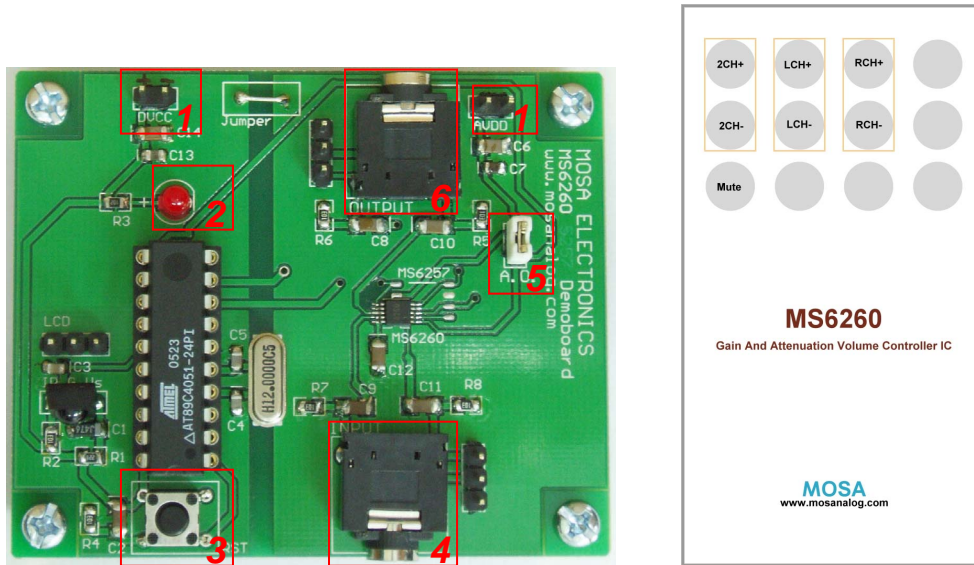

Label 1: Supply Voltage

The AVDD and DVDD should be the same supply voltage, the supply range is 2.7~6.5 VDC.

Label 2: LED Indicator

The LED indicates IR received status and power status. It is red-dark blink once when the MCU has received the function code correctly.

Label 3: MCU Reset

Reset MCU controller. The MS6260 will be loaded the default values by MCU. The default states are Volume 0dB and Mute-Off.

Label 4: Input section

Please input stereo audio signal, as music or sine wave.

Label 5: Address option

As the jump is closed, the address code is 88H.
As the jump is open, the address code is 8CH.

Label 6: Output section

Please connected to a post-power-amplifier, as stereo speaker.

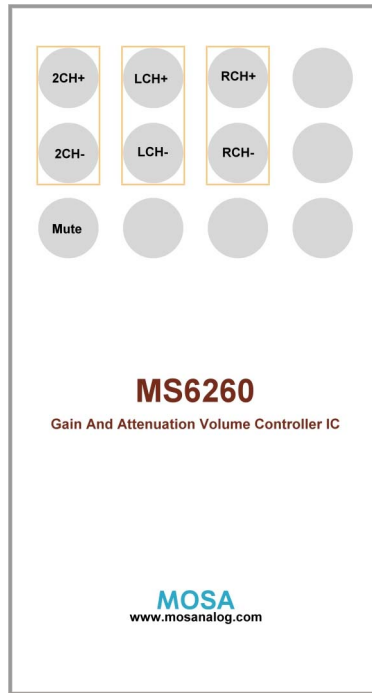

IR Controller

- 2CH+** : The volume-up switch for stereo channel
The volume increase by +1dB as the switch is pressed once, the maximum value is up to +15dB.
The default value is 0dB on initial status.
L-channel and R-channel are active synchronic.
- 2CH-** : The volume-down switch for stereo channel
The volume decrease by -1dB as the switch is pressed once, the minimum value is up to -79dB.
L-channel and R-channel are active synchronic.
- LCH+** : The volume-up switch for left channel
The volume increase by +1dB as the switch is pressed once, the maximum value is up to +15dB.
- LCH-** : The volume-down switch for left channel
The volume decrease by -1dB as the switch is pressed once, the minimum value is up to -79dB.
- RCH+** : The volume-up switch for right channel
The volume increase by +1dB as the switch is pressed once, the maximum value is up to +15dB.
- RCH-** : The volume-down switch for right channel
The volume decrease by -1dB as the switch is pressed once, the minimum value is up to -79dB.
- MUTE** : Press the switch once to enter mute-on or mute-off.
The default status is mute-off on initial status.

Circuit

