

Mono 1.1W, Fully Differential Input Excellent PSRR, Low Voltage Operation

FEATURES

- PSRR at 217Hz, 80dB at 5V
- Operation range: 2.5V~5.5V
- Shutdown Current 0.1uA at 5V
- Output power, THD+N=1%
R_L=8Ω, 1.1W at 5V, 0.4W at 3.3V, 200mW at 2.5V
- Unity-gain stable
- Space-saving SOP8, enhance thermal pad

APPLICATIONS

- Portable electronic devices
- PDAs
- Communication headsets

DESCRIPTION

The MS6895 is a fully differential power amplifier that can drive 1.1W of continuous average power into a mono 8Ω bridged-tied load (BTL). Operation with 2.5V supply, it can drive 200mw into a mono 8Ω. The BTL configuration eliminates the need for external coupling capacitors on the output in most applications. The MS6895 is unity-gain stable and can be configured by external gain-setting resistors.

The MS6895 has good feature for portable equipment, these features include the fully differential input, low voltage operation, micropower consumption shutdown mode, enhance thermal pad and small package SOP8, make the MS6895 ideally suited for use in portable electronic equipments.

BLOCK DIAGRAM

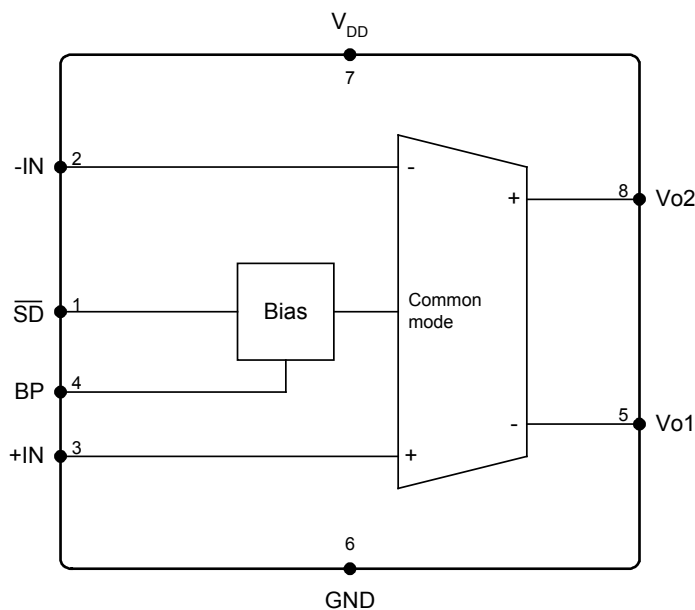

www.DataSheet4U.com

PIN CONFIGURATION

Symbol	Pin	Description
/SD	1	Shutdown places the entire device in shutdown mode when held low. TTL compatible input.
-IN	2	Negative differential input
+IN	3	Positive differential input
BP	4	Bypass is the cap to the voltage divider for internal mid-supply bias. This terminal should be connected to a 0.1- μ F to 10- μ F capacitor C_{BP} .
Vo1	5	Negative BTL output
GND	6	Ground
V _{DD}	7	Supply voltage
Vo2	8	Positive BTL output

SOP8

ORDERING INFORMATION

Package	Part number	Packaging Marking	Transport Media
8-Pin SOP (lead free)	MS6895GTR	6895G	2.5k Units Tape and Reel
8-Pin SOP (lead free)	MS6895GU	6895G	100 Units Tube

RoHS Compliance

ABSOLUTE MAXIMUM RATINGS

Symbol	Parameter	Rating	Unit
V _{DD}	Supply voltage	6	V
V _{ESD}	Electrostatic handling	3500	V
T _{STG}	Storage temperature range	-65 to 150	°C
T _A	Operating ambient temperature range	-40 to 85	°C
T _J	Maximum junction temperature	150	°C
T _S	Soldering temperature, 10 seconds	260	°C
R _{THJA}	Thermal resistance from junction to ambient in free air SOP8 (enhance thermal pad)	50	°C/W

OPERATING RATINGS

Symbol	Parameter	Min	Typ	Max	Unit
V _{DD}	Supply voltage	2.5	5	5.5	V

5V ELECTRICAL CHARACTERISTICS

T_a = 25°C, V_{DD}=5V, f=1kHz, BW<30kHz, unless otherwise specified.

Symbol	Parameter	Conditions	Min	Typ	Max	Unit
I _Q	Quiescent current	V _{IN} =0V, I _O =0A	-	2.7	-	mA
I _{SHDN}	Shutdown current	V _{SHDN} =0V	-	0.1	-	uA
V _{SDH}	Shutdown input voltage high		2.0	-	-	V
V _{SDL}	Shutdown input voltage low		-	-	0.8	V
PSRR	Power supply rejection ratio	R _L =8Ω, C _{BP} =1uF, f=217Hz	-	80	-	dB
THD+N	Total harmonic distortion plus noise	R _L =8Ω, 1.1W	-	-60	-55	dB
			-	0.1	0.178	%
S/N	Signal-to-noise ratio	R _L =8Ω, 1.1W	90	103	-	dB
P _o	Output power	R _L =8Ω, THD+N = 1%	1.1	1.3	-	W

3.3V ELECTRICAL CHARACTERISTICS

T_a = 25°C, V_{DD}=3.3V, f=1kHz, BW<30kHz, unless otherwise specified.

Symbol	Parameter	Conditions	Min	Typ	Max	Unit
I _Q	Quiescent current	V _{IN} =0V, I _O =0A	-	2.4	-	mA
I _{SD}	Shutdown current	V _{SHDN} =0V	-	0.1	-	uA
PSRR	Power supply rejection ratio	R _L =8Ω, C _{BP} =1uF, f=217Hz	-	70	-	dB
THD+N	Total harmonic distortion plus noise	R _L =8, 0.4W	-	-60	-55	dB
			-	0.1	0.178	%
S/N	Signal-to-noise ratio	R _L =8Ω, 0.4W	90	100	-	dB
P _o	Output power	R _L =8Ω, THD+N = 1%	0.4	0.5	-	W

2.5V ELECTRICAL CHARACTERISTICS

T_a = 25°C, V_{DD}=2.5V, f=1kHz, BW<30kHz, unless otherwise specified.

Symbol	Parameter	Conditions	Min	Typ	Max	Unit
I _Q	Quiescent current	V _{IN} =0V, I _O =0A	-	2.2	-	mA
I _{SD}	Shutdown current	V _{SHDN} =0V	-	0.1	-	uA
PSRR	Power supply rejection ratio	R _L =8Ω, C _{BP} =1uF, f=217Hz	-	60	-	dB
THD+N	Total harmonic distortion plus noise	R _L =8Ω, 0.2W	-	-60	-55	dB
			-	0.1	0.178	%
S/N	Signal-to-noise ratio	R _L =8Ω, 0.2W	90	98	-	dB
P _o	Output power	R _L =8Ω, THD+N = 1%	0.2	0.28	-	W

TYPICAL PERFORMANCE CHARACTERISTICS

Ta = 25°C, BW < 30kHz, unless otherwise specified.

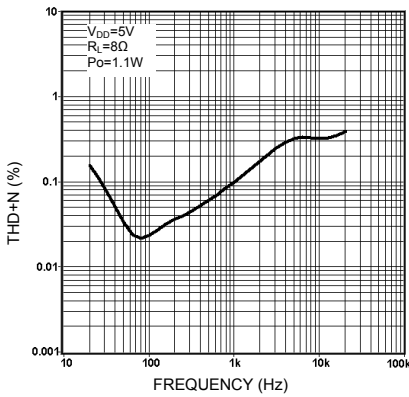

THD+N vs. frequency

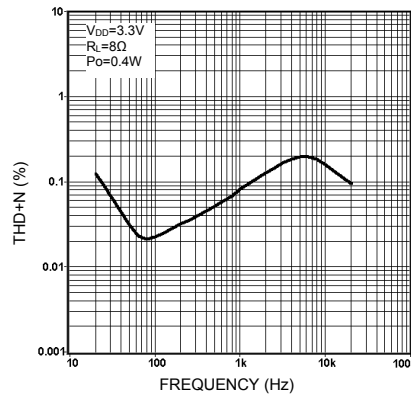

THD+N vs. frequency

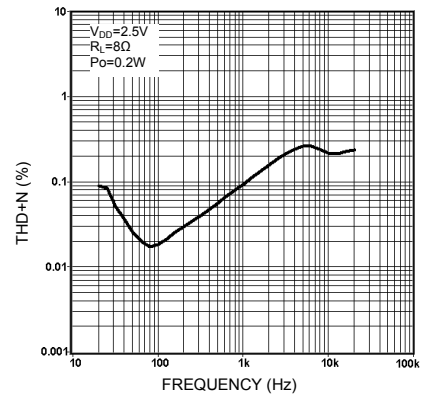

THD+N vs. frequency

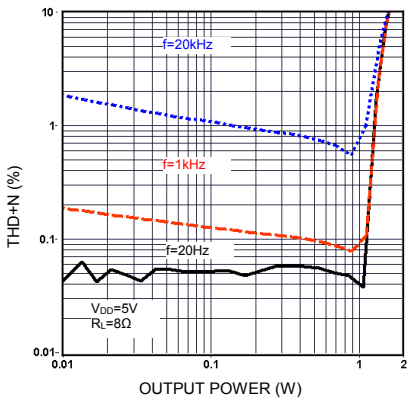

THD+N vs. output power

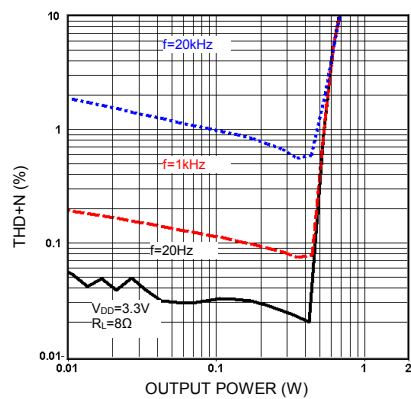

THD+N vs. output power

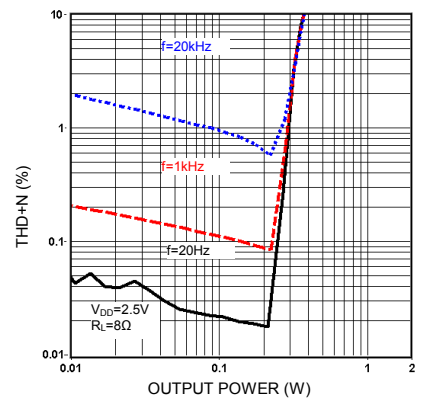

THD+N vs. output power

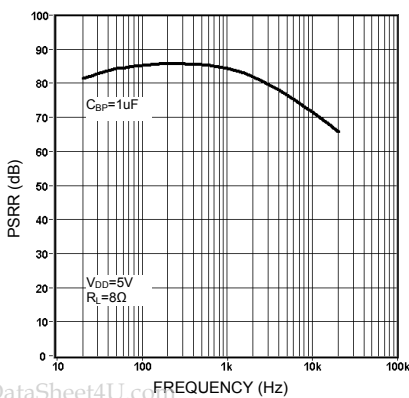

PSRR vs. frequency

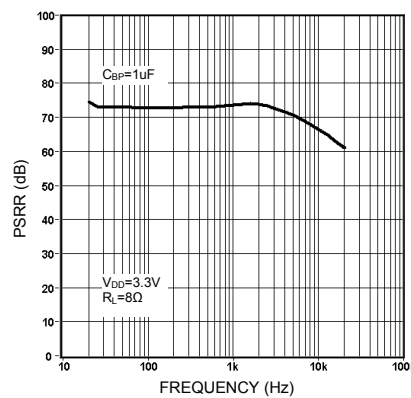

PSRR vs. frequency

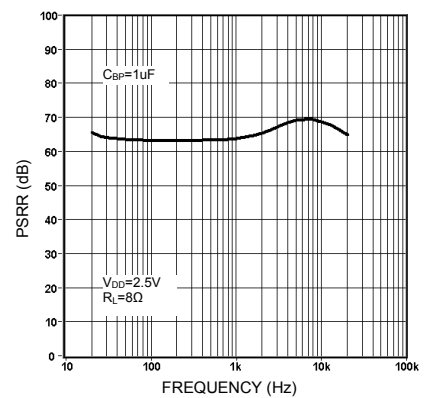

PSRR vs. frequency

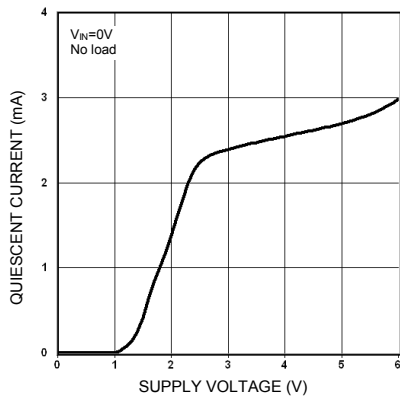

APPLICATION INFORMATION

Basic application example

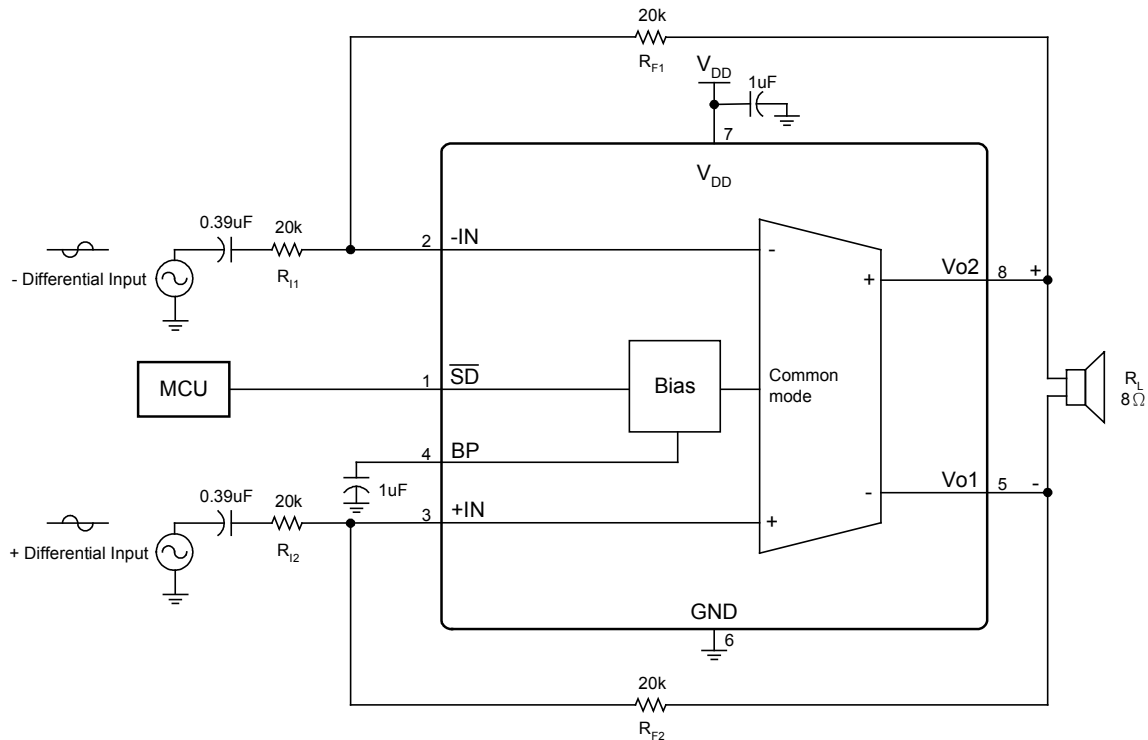

Fig.1 A audio amplifier application circuit.

External gain-setting

As shown in Fig.1, $R_{I1} = R_{I2}$ and $R_{F1} = R_{F2}$, the respective closed-loop gain is set at $-R_F/R_I$. It is important to match input resistors and feedback resistors to each other. The outputs are used to drive the mono bridged-tied load (BTL).

High Pass Filter

The input capacitor C_{IN} and resistor R_{IN} are decided the cut-off frequency of the HPF. The equation is as follows:

$$f_{\text{cut-off}} = 1 / (2 \pi * R_{IN} * C_{IN})$$

Thermal pad considerations

The thermal pad must be connected to ground. The package with thermal pad of the MS6895 requires special attention on thermal design. The thermal pad on the bottom of the MS6895 should be soldered down to a copper pad on the circuit board. Heat can be conducted away from the thermal pad through the copper plane to ambient. If the copper plane is not on the top surface of the circuit board, 9 vias of 13 mil or smaller in diameter should be used to thermally couple the thermal pad to the bottom plane. For good thermal conduction, the vias must be plated through and solder filled.

EXTERNAL DIMENSIONS

SOP8 (Thermal Pad)

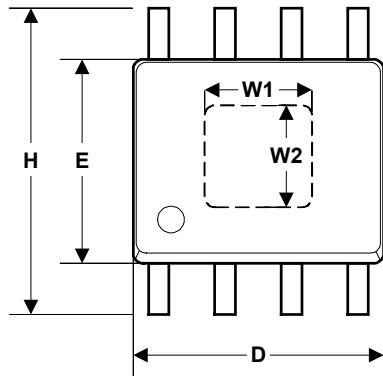

Symbol	Dimension in mm		Dimension in inch	
	Min	Max	Min	Max
A	1.35	1.75	0.0532	0.0688
A1	0.10	0.25	0.0040	0.0098
B	0.33	0.51	0.013	0.020
C	0.19	0.25	0.0075	0.0098
D	4.80	5.00	0.1890	0.1968
H	5.80	6.20	0.2284	0.2440
E	3.80	4.00	0.1497	0.1574
e	1.27 BSC		0.050 BSC	
L	0.40	1.27	0.016	0.050
W1	2.159	2.413	0.085	0.095
W2	2.159	2.413	0.085	0.095

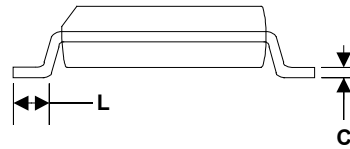
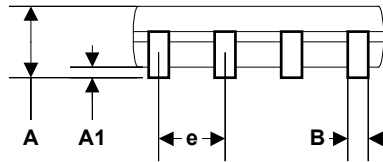

TAPE AND REEL (Unit : mm)

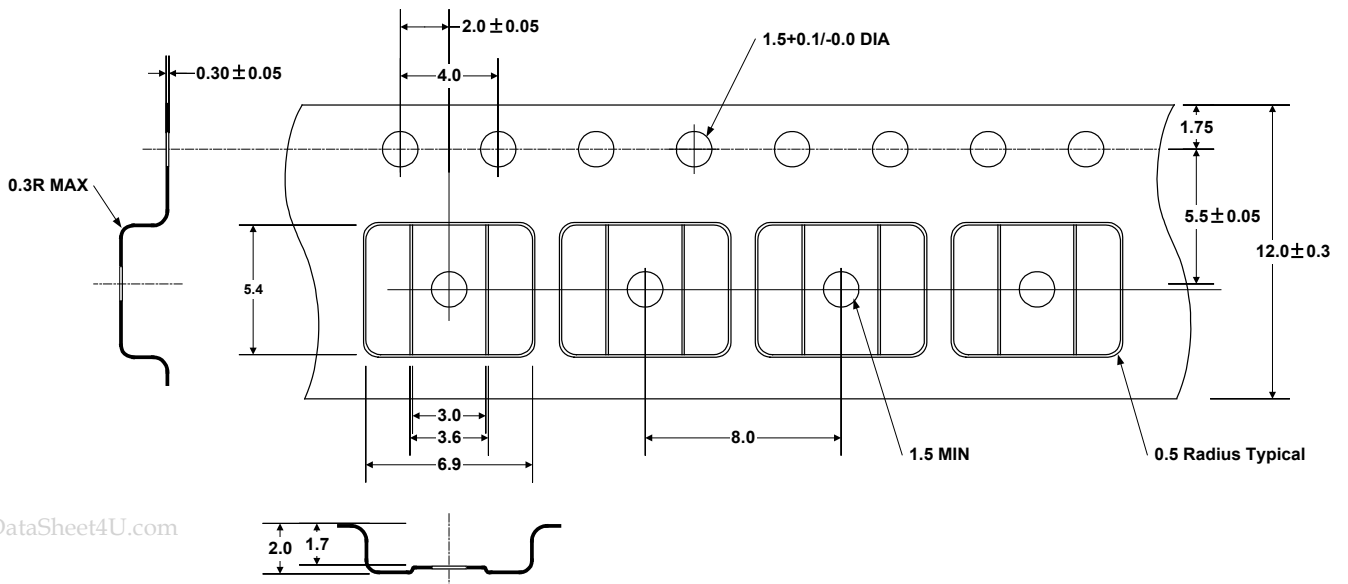

SOP8