



Cascadable Silicon Bipolar MMIC Amplifier

Technical Data

MSA-0311

Features

- **Cascadable 50 Ω Gain Block**
- **3 dB Bandwidth:**
DC to 2.3 GHz
- **11.0 dB Typical Gain at 1.0 GHz**
- **9.0 dBm Typical $P_{1\text{ dB}}$ at --1.0 GHz**
- **Unconditionally Stable ($k > 1$)**
- **Low Cost Surface Mount Plastic Package**
- **Tape-and-Reel Packaging Option Available^[1]**

Note:

1. Refer to PACKAGING section "Tape-and-Reel Packaging for Semiconductor Devices".

Description

The MSA-0311 is a low cost silicon bipolar Monolithic Microwave Integrated Circuit (MMIC) housed in the surface mount plastic SOT-143 package. This MMIC is designed for use as a general purpose 50 Ω gain block. Typical applications include narrow and broad band IF and RF amplifiers in commercial and industrial applications.

The MSA-series is fabricated using Agilent's 10 GHz f_T , 25 GHz f_{MAX} , silicon bipolar MMIC process which uses nitride self-alignment, ion implantation, and gold metalli-

SOT-143 Package

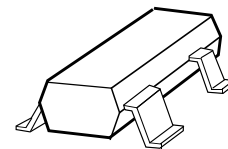

zation to achieve excellent performance, uniformity and reliability. The use of an external bias resistor for temperature and current stability also allows bias flexibility.

Typical Biasing Configuration

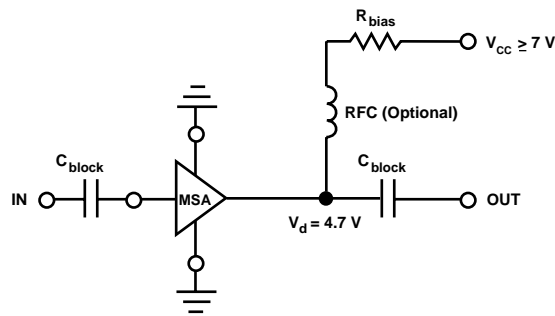

MSA-0311 Absolute Maximum Ratings

Parameter	Absolute Maximum ^[1]
Device Current	60 mA
Power Dissipation ^[2,3]	240 mW
RF Input Power	+13 dBm
Junction Temperature	150°C
Storage Temperature	-65 to 150°C

Thermal Resistance^{[2,4]:}

$$\theta_{jc} = 500^{\circ}\text{C}/\text{W}$$

Notes:

1. Permanent damage may occur if any of these limits are exceeded.
2. $T_{\text{CASE}} = 25^{\circ}\text{C}$.
3. Derate at 2.0 mW/°C for $T_{\text{C}} > 30^{\circ}\text{C}$.
4. See MEASUREMENTS section "Thermal Resistance" for more information.

Electrical Specifications^[1], $T_{\text{A}} = 25^{\circ}\text{C}$

Symbol	Parameters and Test Conditions: $I_{\text{d}} = 35 \text{ mA}$, $Z_{\text{o}} = 50 \Omega$	Units	Min.	Typ.	Max.
G _P	Power Gain ($ S_{21} ^2$) f = 0.1 GHz f = 1.0 GHz	dB	9.0	11.5 11.0	
ΔG_{P}	Gain Flatness f = 0.1 to 1.6 GHz	dB		± 0.7	
f _{3 dB}	3 dB Bandwidth	GHz		2.3	
VSWR	Input VSWR f = 0.1 to 3.0 GHz			1.5:1	
	Output VSWR f = 0.1 to 3.0 GHz			1.7:1	
NF	50 Ω Noise Figure f = 1.0 GHz	dB		6.0	
P _{1 dB}	Output Power at 1 dB Gain Compression f = 1.0 GHz	dBm		9.0	
IP ₃	Third Order Intercept Point f = 1.0 GHz	dBm		22.0	
t _D	Group Delay f = 1.0 GHz	psec		140	
V _d	Device Voltage T _C = 25°C	V	3.8	4.7	5.6
dV/dT	Device Voltage Temperature Coefficient	mV/°C		-8.0	

Notes:

1. The recommended operating current range for this device is 20 to 40 mA. Typical gain performance as a function of current is on the following page.

Part Number Ordering Information

Part Number	No. of Devices	Container
MSA-0311-TR1	3000	7" Reel
MSA-0311-BLK	100	Antistatic Bag

For more information, see "Tape and Reel Packaging for Semiconductor Devices".

MSA-0311 Typical Scattering Parameters ($Z_0 = 50 \Omega$, $T_A = 25^\circ\text{C}$, $I_d = 35 \text{ mA}$)

Freq. GHz	S ₁₁		S ₂₁			S ₁₂			S ₂₂	
	Mag	Ang	dB	Mag	Ang	dB	Mag	Ang	Mag	Ang
0.1	.06	25	11.7	3.84	175	-17.9	.127	2	.24	-7
0.2	.07	31	11.7	3.83	170	-17.9	.128	3	.23	-13
0.4	.07	38	11.6	3.78	159	-17.8	.129	6	.24	-28
0.6	.07	30	11.4	3.72	149	-17.6	.132	18	.24	-40
0.8	.08	21	11.2	3.65	140	-17.3	.136	11	.24	-53
1.0	.08	10	11.0	3.56	130	-17.0	.141	13	.24	-65
1.5	.09	-32	10.4	3.31	106	-15.9	.160	17	.24	-91
2.0	.09	-105	9.5	2.99	84	-14.9	.179	16	.23	-115
2.5	.13	-151	8.5	2.66	70	-14.1	.197	19	.23	-133
3.0	.19	-176	7.4	2.35	51	-13.5	.212	15	.22	-145
3.5	.24	166	6.2	2.04	35	-13.0	.224	11	.23	-151
4.0	.27	152	5.1	1.80	20	-12.7	.232	6	.24	-151
5.0	.36	114	2.9	1.39	-6	-12.1	.250	-1	.25	-152
6.0	.50	88	0.8	1.10	-28	-11.8	.258	-8	.25	-166

A model for this device is available in the DEVICE MODELS section.

Typical Performance, $T_A = 25^\circ\text{C}$

(unless otherwise noted)

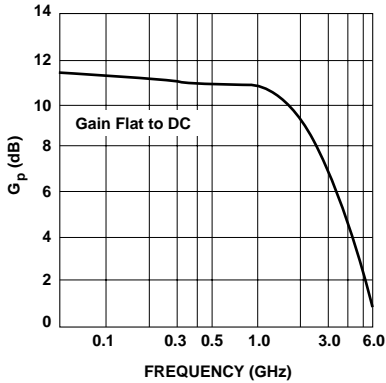

Figure 1. Typical Power Gain vs. Frequency, $I_d = 35 \text{ mA}$.

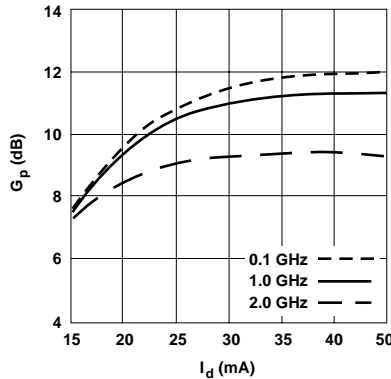

Figure 2. Power Gain vs. Current.

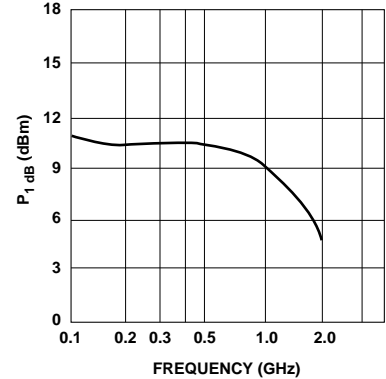

Figure 3. Output Power at 1 dB Gain Compression vs. Frequency, $I_d = 35 \text{ mA}$.

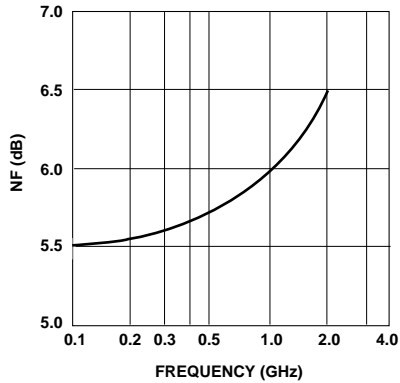
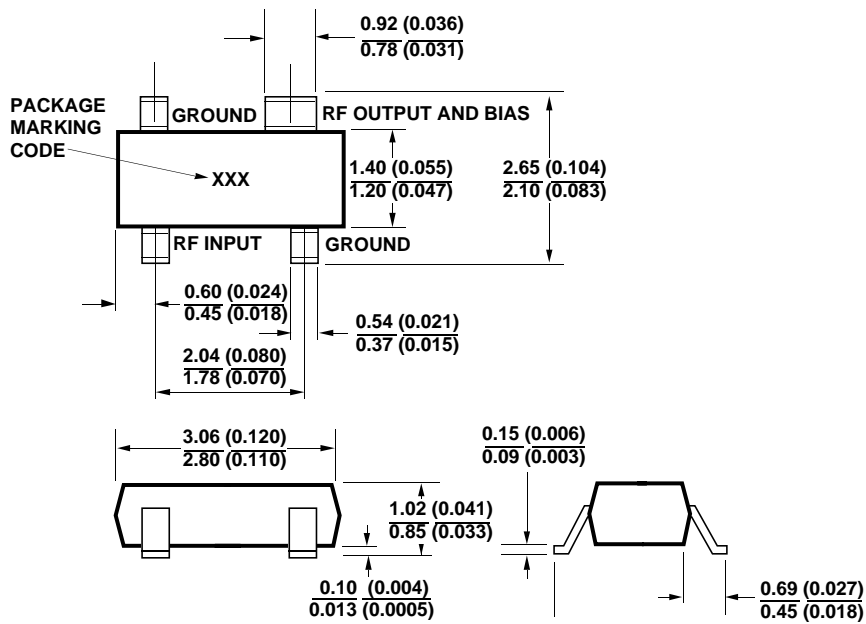

Figure 4. Noise Figure vs. Frequency, $I_d = 35 \text{ mA}$.



SOT-143 Package Dimensions



DIMENSIONS ARE IN MILLIMETERS (INCHES)

Package marking code is "A03"