

# Cascadable Silicon Bipolar MMIC Amplifier

## Technical Data

**MSA-0504**

### Features

- **Cascadable 50 Ω Gain Block**
- **High Output Power:**  
18.0 dBm Typical  $P_{1\text{ dB}}$  at 1.0 GHz
- **Low Distortion:**  
29.0 dBm Typical  $IP_3$  at 1.0 GHz
- **7.0 dB Typical Gain at 1.0 GHz**
- **Low Cost Plastic Package**

### Description

The MSA-0504 is a high performance medium power silicon bipolar Monolithic Microwave Integrated Circuit (MMIC) housed

in a low cost plastic package. This MMIC is designed for use as a general purpose 50 Ω gain block. Typical applications include narrow and broad band IF and RF amplifiers in commercial systems.

The MSA-series is fabricated using HP's 10 GHz  $f_T$ , 25 GHz  $f_{MAX}$ , silicon bipolar MMIC process which uses nitride self-alignment, ion implantation, and gold metallization to achieve excellent performance, uniformity and reliability. The use of an external bias resistor for temperature and current stability also allows bias flexibility.

### 04A Plastic Package

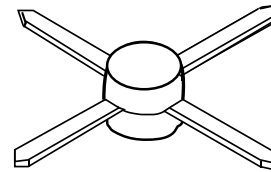

### Typical Biasing Configuration

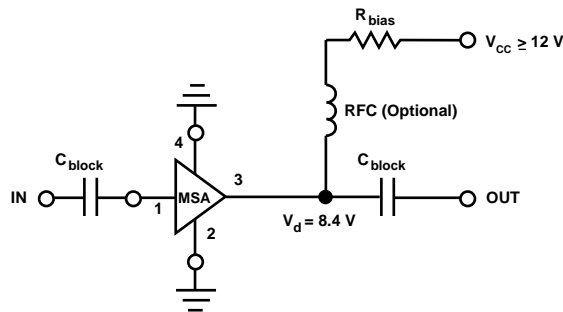

## MSA-0504 Absolute Maximum Ratings

Parameter	Absolute Maximum <sup>[1]</sup>
Device Current	135 mA
Power Dissipation <sup>[2,3]</sup>	1.5 W
RF Input Power	+25 dBm
Junction Temperature	200°C
Storage Temperature	-65 to 150°C

### Thermal Resistance<sup>[2,4]</sup>:

$$\theta_{jc} = 75^{\circ}\text{C/W}$$

#### Notes:

1. Permanent damage may occur if any of these limits are exceeded.
2.  $T_{\text{CASE}} = 25^{\circ}\text{C}$ .
3. Derate at 13.3 mW/°C for  $T_{\text{C}} > 88^{\circ}\text{C}$ .
4. See MEASUREMENTS section "Thermal Resistance" for more information.

## Electrical Specifications<sup>[1]</sup>, $T_{\text{A}} = 25^{\circ}\text{C}$

Symbol	Parameters and Test Conditions: $I_{\text{d}} = 80 \text{ mA}$ , $Z_{\text{o}} = 50 \Omega$	Units	Min.	Typ.	Max.
$P_{1 \text{ dB}}$	Output Power at 1 dB Gain Compression	f = 0.5 GHz		19.0	
		f = 1.0 GHz	dBm	16.0	18.0
$G_{\text{P}}$	Power Gain ( $ S_{21} ^2$ )	f = 0.5 GHz	dB	7.5	
		f = 1.0 GHz		6.0	7.0
$\Delta G_{\text{P}}$	Gain Flatness	f = 0.1 to 1.5 GHz	dB	$\pm 0.75$	
$f_{3 \text{ dB}}$	3 dB Bandwidth <sup>[2]</sup>		GHz	2.3	
VSWR	Input VSWR	f = 0.1 to 1.5 GHz		1.6:1	
	Output VSWR	f = 0.1 to 1.5 GHz		2.0:1	
$\text{IP}_3$	Third Order Intercept Point	f = 1.0 GHz	dBm	29.0	
NF	50 $\Omega$ Noise Figure	f = 1.0 GHz	dB	6.5	
$t_{\text{D}}$	Group Delay	f = 1.0 GHz	psec	180	
$V_{\text{d}}$	Device Voltage		V	6.7	10.1
$\text{dV/dT}$	Device Voltage Temperature Coefficient		mV/°C	-16.0	

#### Notes:

1. The recommended operating current range for this device is 60 to 100 mA. Typical performance as a function of current is on the following page.
2. Referenced from 0.1 GHz Gain ( $G_{\text{P}}$ ).

### MSA-0504 Typical Scattering Parameters ( $T_A = 25^\circ\text{C}$ , $I_d = 80\text{ mA}$ )

Freq. MHz	$S_{11}$		$S_{21}$			$S_{12}$			$S_{22}$		k
	Mag	Ang	dB	Mag	Ang	dB	Mag	Ang	Mag	Ang	
5	.54	-43	14.7	5.43	160	-18.4	.120	37	.63	-39	0.60
25	.24	-112	9.3	2.92	155	-13.8	.204	12	.24	-101	0.99
50	.18	-142	8.1	2.54	161	-13.7	.206	3	.16	-125	1.17
100	.14	-156	7.8	2.45	166	-13.7	.207	3	.13	-137	1.18
200	.14	-168	7.6	2.40	163	-13.7	.206	1	.13	-146	1.20
400	.14	-174	7.5	2.37	150	-13.7	.206	1	.16	-143	1.19
600	.14	-175	7.4	2.34	137	-13.6	.208	-1	.20	-144	1.18
800	.15	-174	7.2	2.29	124	-13.5	.211	-1	.25	-148	1.15
1000	.17	-174	7.0	2.24	111	-13.6	.209	-3	.29	-154	1.14
1500	.23	-179	6.4	2.09	80	-13.3	.216	-4	.37	-168	1.06
2000	.33	171	5.5	1.88	51	-12.8	.230	-10	.48	178	0.91
2500	.42	156	4.3	1.64	27	-13.0	.224	-12	.51	165	0.90
3000	.49	146	3.2	1.44	6	-12.8	.230	-11	.55	157	0.92

A model for this device is available in the DEVICE MODELS section.

### Typical Performance, $T_A = 25^\circ\text{C}$

(unless otherwise noted)

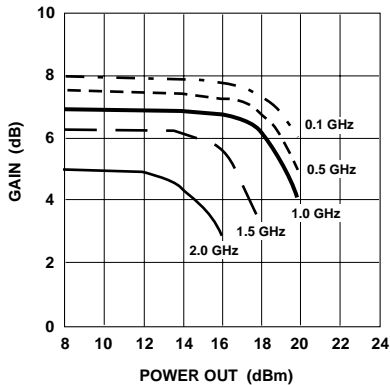

Figure 1. Typical Gain vs. Power Out,  $T_A = 25^\circ\text{C}$ ,  $I_d = 80\text{ mA}$ .

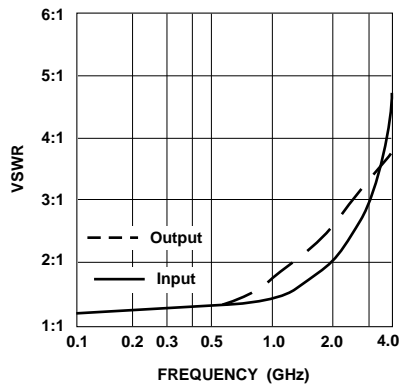

Figure 2. VSWR vs. Frequency,  $I_d = 80\text{ mA}$ .

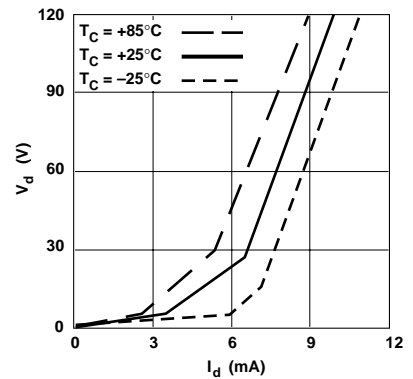

Figure 3. Device Current vs. Voltage.

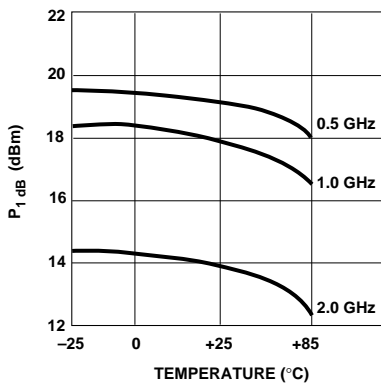

Figure 4. Output Power at 1 dB Gain Compression, vs. Case Temperature,  $I_d = 80\text{ mA}$ .

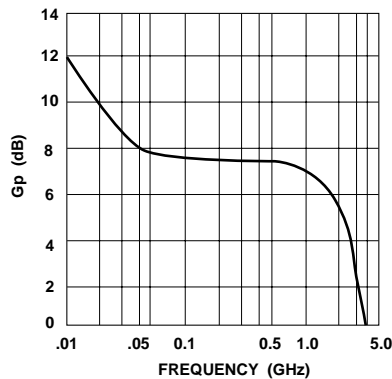

Figure 5. Gain vs. Frequency,  $I_d = 80\text{ to }100\text{ mA}$ .

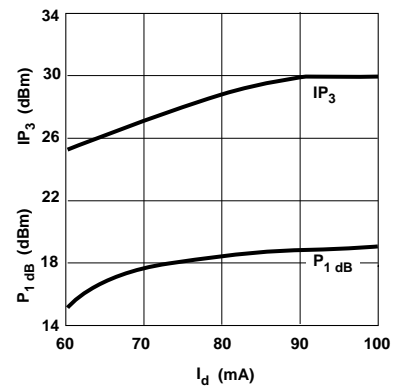

Figure 6. Output Power at 1 dB Gain Compression, Third Order Intercept vs. Current,  $f = 1.0\text{ GHz}$ .

# 04A Plastic Package Dimensions

