

Cascadable Silicon Bipolar MMIC Amplifier

Technical Data

MSA-0910

Features

- **Broadband, Minimum Ripple Cascadable 50 Ω Gain Block**
- **8.0 ± 0.2 dB Typical Gain Flatness from 0.1 to 4.0 GHz**
- **3 dB Bandwidth:** 0.1 to 6.0 GHz
- **Low VSWR:** ≤ 1.5:1 from 0.1 to 4.0 GHz
- **11.5 dBm Typical P_{1dB} at 1.0 GHz**
- **Hermetic Gold-ceramic Microstrip Package**

Description

The MSA-0910 is a high performance silicon bipolar Monolithic Microwave Integrated Circuit (MMIC) housed in a hermetic, high reliability package. This MMIC is designed for very wide bandwidth industrial and military applications that require flat gain and low VSWR.

The MSA-series is fabricated using HP's 10 GHz f_T , 25 GHz f_{MAX} , silicon bipolar MMIC process which uses nitride self-alignment, ion implantation, and gold metallization to achieve excellent performance, uniformity and reliability. The use of an external bias resistor for temperature and current stability also allows bias flexibility.

100 mil Package

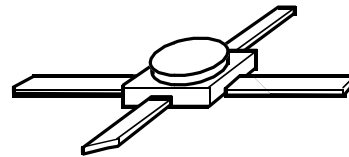

Typical Biasing Configuration

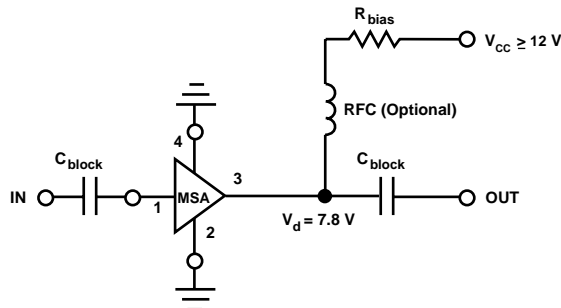

MSA-0910 Absolute Maximum Ratings

Parameter	Absolute Maximum ^[1]
Device Current	80 mA
Power Dissipation ^[2,3]	750 mW
RF Input Power	+13 dBm
Junction Temperature	200°C
Storage Temperature	-65 to 200°C

Thermal Resistance^[2,4]:

$$\theta_{jc} = 145^{\circ}\text{C/W}$$

Notes:

1. Permanent damage may occur if any of these limits are exceeded.
2. $T_{\text{CASE}} = 25^{\circ}\text{C}$.
3. Derate at $6.9 \text{ mW}/^{\circ}\text{C}$ for $T_{\text{C}} > 91^{\circ}\text{C}$.
4. The small spot size of this technique results in a higher, though more accurate determination of θ_{jc} than do alternate methods. See MEASUREMENTS section "Thermal Resistance" for more information.

Electrical Specifications^[1], $T_{\text{A}} = 25^{\circ}\text{C}$

Symbol	Parameters and Test Conditions: $I_{\text{d}} = 35 \text{ mA}$, $Z_{\text{o}} = 50 \Omega$	Units	Min.	Typ.	Max.
G_{P}	PowerGain ($ S_{21} ^2$) $f = 0.1 \text{ GHz}$	dB	7.0	8.0	9.0
ΔG_{P}	Gain Flatness $f = 0.1 \text{ to } 4.0 \text{ GHz}$	dB		± 0.2	± 0.5
$f_{3 \text{ dB}}$	3 dB Bandwidth ^[2]	GHz		6.0	
VSWR	Input VSWR $f = 1.0 \text{ to } 4.0 \text{ GHz}$			1.3:1	
	Output VSWR $f = 1.0 \text{ to } 4.0 \text{ GHz}$			1.5:1	
NF	50 Ω Noise Figure $f = 1.0 \text{ GHz}$ $f = 4.0 \text{ GHz}$	dB		6.0 6.5	
$P_{1 \text{ dB}}$	Output Power at 1 dB Gain Compression $f = 1.0 \text{ GHz}$ $f = 4.0 \text{ GHz}$	dBm		11.5 6.5	
IP_3	Third Order Intercept Point $f = 1.0 \text{ GHz}$	dBm		23.0	
t_{D}	Group Delay $f = 1.0 \text{ GHz}$	psec		100	
V_{d}	Device Voltage	V	7.0	7.8	8.6
dV/dT	Device Voltage Temperature Coefficient	mV/ $^{\circ}\text{C}$		-16.0	

Notes:

1. The recommended operating current range for this device is 25 to 45 mA. Typical performance as a function of current is on the following page.
2. Referenced from 0.1 GHz gain (G_{P}).

MSA-0910 Typical Scattering Parameters ($Z_0 = 50 \Omega$, $T_A = 25^\circ\text{C}$, $I_d = 35 \text{ mA}$)

Freq. GHz	S ₁₁		S ₂₁			S ₁₂			S ₂₂		k
	Mag	Ang	dB	Mag	Ang	dB	Mag	Ang	Mag	Ang	
0.02	.31	-108	10.6	3.38	150	-13.8	.202	16	.31	-107	0.85
0.05	.18	-114	8.8	2.75	160	-13.5	.212	8	.20	-117	1.06
0.1	.12	-141	8.1	2.53	166	-13.4	.214	3	.14	-139	1.16
0.2	.10	-166	7.9	2.47	167	-13.4	.215	1	.13	-157	1.19
0.4	.10	170	7.8	2.46	163	-13.3	.215	-1	.12	-165	1.20
0.6	.10	156	7.8	2.45	157	-13.3	.216	-3	.13	-167	1.20
0.8	.10	145	7.8	2.46	151	-13.3	.216	-4	.13	-168	1.19
1.0	.10	133	7.8	2.46	144	-13.3	.217	-6	.14	-169	1.19
1.5	.10	111	7.9	2.49	127	-13.2	.220	-10	.16	-173	1.17
2.0	.09	88	8.0	2.51	110	-13.0	.224	-13	.18	177	1.15
2.5	.07	89	8.2	2.58	96	-12.8	.230	-16	.21	167	1.11
3.0	.04	90	8.2	2.58	78	-12.8	.230	-21	.20	151	1.11
3.5	.06	145	8.2	2.57	59	-12.7	.233	-27	.19	137	1.11
4.0	.12	152	8.0	2.50	40	-12.7	.230	-33	.16	125	1.12
4.5	.19	142	7.5	2.38	22	-13.0	.223	-40	.13	116	1.16
5.0	.26	131	6.9	2.21	4	-13.5	.211	-47	.09	118	1.22
5.5	.32	120	6.2	2.04	-12	-14.1	.198	-52	.07	160	1.28
6.0	.38	109	5.3	1.84	-27	-14.8	.181	-56	.13	-173	1.38
6.5	.43	99	4.4	1.65	-42	-15.6	.167	-59	.21	-172	1.46

A model for this device is available in the DEVICE MODELS section.

Typical Performance, $T_A = 25^\circ\text{C}$

(unless otherwise noted)

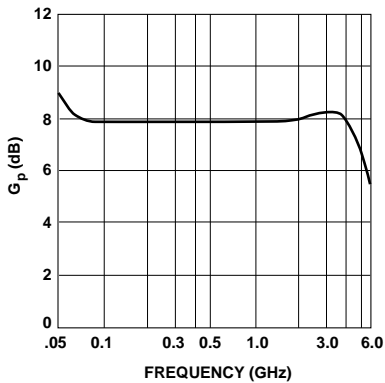

Figure 1. Typical Power Gain vs. Frequency, $I_d = 35 \text{ mA}$.

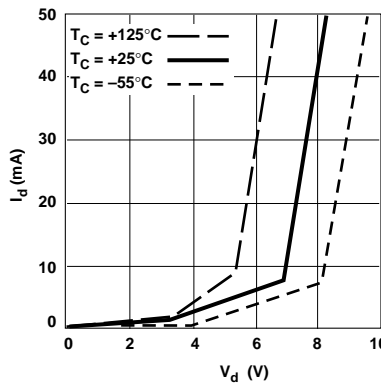

Figure 2. Device Current vs. Voltage.

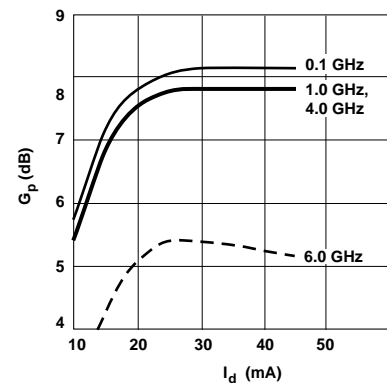

Figure 3. Power Gain vs. Current.

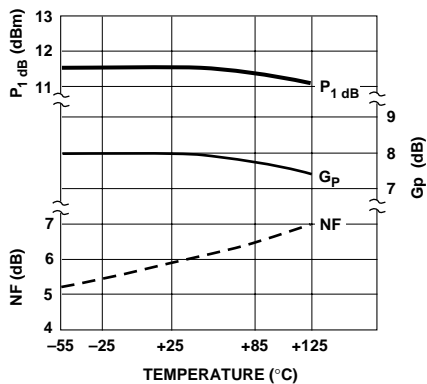

Figure 4. Output Power at 1 dB Gain Compression, Noise Figure and Power Gain vs. Case Temperature, $f = 1.0 \text{ GHz}$, $I_d = 35 \text{ mA}$.

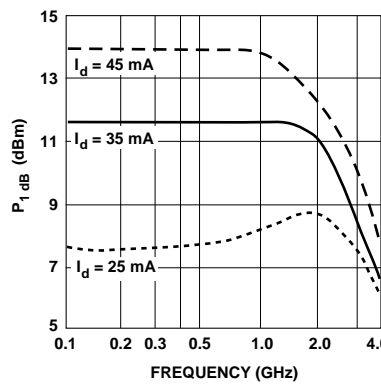

Figure 5. Output Power at 1 dB Gain Compression vs. Frequency.

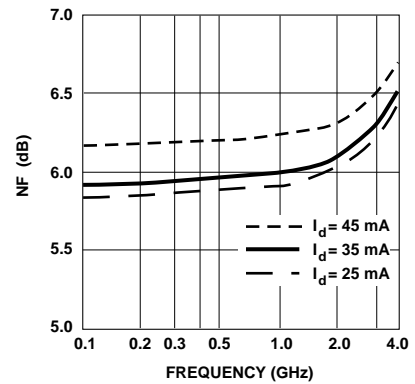

Figure 6. Noise Figure vs. Frequency.

100 mil Package Dimensions

Outline 10A

