

Cascadable Silicon Bipolar MMIC Amplifier

Technical Data

MSA-0886

Features

- **Usable Gain to 5.5 GHz**
- **High Gain:**
32.5 dB Typical at 0.1 GHz
22.5 dB Typical at 1.0 GHz
- **Low Noise Figure:**
3.3 dB Typical at 1.0 GHz
- **Surface Mount Plastic Package**
- **Tape-and-Reel Packaging Option Available⁽¹⁾**

Note:

1. Refer to PACKAGING section "Tape-and-Reel Packaging for Semiconductor Devices."

Description

The MSA-0886 is a high performance silicon bipolar Monolithic Microwave Integrated Circuit (MMIC) housed in a low cost, surface mount plastic package. This MMIC is designed for use as a general purpose 50 Ω gain block above 0.5 GHz and can be used as a high gain transistor below this frequency. Typical applications include narrow and moderate band IF and RF amplifiers in commercial and industrial applications.

The MSA-series is fabricated using HP's 10 GHz f_T , 25 GHz f_{MAX} , silicon bipolar MMIC process which uses nitride self-alignment,

86 Plastic Package

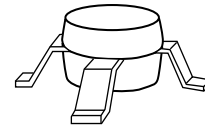

ion implantation, and gold metallization to achieve excellent performance, uniformity and reliability. The use of an external bias resistor for temperature and current stability also allows bias flexibility.

Typical Biasing Configuration

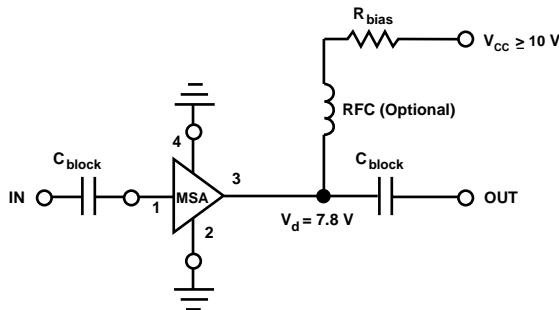

MSA-0886 Absolute Maximum Ratings

Parameter	Absolute Maximum ^[1]
Device Current	65 mA
Power Dissipation ^[2,3]	500 mW
RF Input Power	+13 dBm
Junction Temperature	150°C
Storage Temperature	-65°C to 150°C

Thermal Resistance^{[2,4]:}

$$\theta_{jc} = 140^{\circ}\text{C/W}$$

Notes:

1. Permanent damage may occur if any of these limits are exceeded.
2. $T_{\text{CASE}} = 25^{\circ}\text{C}$.
3. Derate at 7.1 mW/°C for $T_{\text{C}} > 80^{\circ}\text{C}$.
4. See MEASUREMENTS section “Thermal Resistance” for more information.

Electrical Specifications^[1], $T_{\text{A}} = 25^{\circ}\text{C}$

Symbol	Parameters and Test Conditions: $I_{\text{d}} = 36 \text{ mA}$, $Z_0 = 50 \Omega$	Units	Min.	Typ.	Max.
GP	Power Gain ($ S_{21} ^2$) f = 0.1 GHz f = 1.0 GHz	dB	20.5	32.5 22.5	
VSWR	Input VSWR f = 0.1 to 3.0 GHz			2.1:1	
	Output VSWR f = 0.1 to 3.0 GHz			1.9:1	
NF	50 Ω Noise Figure f = 1.0 GHz	dB		3.3	
P ₁ dB	Output Power at 1 dB Gain Compression f = 1.0 GHz	dBm		12.5	
IP ₃	Third Order Intercept Point f = 1.0 GHz	dBm		27.0	
t _D	Group Delay f = 1.0 GHz	psec		140	
V _d	Device Voltage	V	6.2	7.8	9.4
dV/dT	Device Voltage Temperature Coefficient	mV/°C		-17.0	

Note:

1. The recommended operating current range for this device is 20 to 40 mA. Typical performance as a function of current is on the following page.

Part Number Ordering Information

Part Number	No. of Devices	Container
MSA-0886-TR1	1000	7" Reel
MSA-0886-BLK	100	Antistatic Bag

For more information, see “Tape and Reel Packaging for Semiconductor Devices”.

MSA-0886 Typical Scattering Parameters^[1] ($Z_0 = 50 \Omega$, $T_A = 25^\circ\text{C}$, $I_d = 36 \text{ mA}$)

Freq. GHz	S_{11}		S_{21}			S_{12}			S_{22}		k
	Mag	Ang	dB	Mag	Ang	dB	Mag	Ang	Mag	Ang	
0.1	.63	-22	32.5	42.12	160	-36.7	.015	54	.62	-24	0.68
0.2	.56	-41	31.3	36.68	143	-33.9	.020	50	.55	-46	0.64
0.4	.43	-69	28.6	26.94	119	-29.1	.035	52	.43	-79	0.69
0.6	.35	-88	26.4	20.89	104	-27.0	.045	49	.34	-103	0.77
0.8	.30	-104	24.2	16.21	93	-25.3	.054	50	.29	-124	0.83
1.0	.27	-116	22.4	13.20	83	-24.2	.062	49	.26	-139	0.87
1.5	.27	-144	19.2	9.15	65	-21.6	.083	46	.23	-172	0.93
2.0	.31	-166	16.7	6.84	49	-19.5	.105	41	.22	163	0.96
2.5	.35	178	14.8	5.50	38	-17.9	.128	36	.21	149	0.96
3.0	.40	162	12.9	4.41	25	-17.4	.135	30	.20	132	1.01
3.5	.45	149	11.4	3.72	13	-16.8	.145	25	.19	124	1.02
4.0	.51	137	9.9	3.14	1	-16.1	.157	19	.18	121	1.01
5.0	.61	116	7.3	2.31	-22	-15.7	.164	10	.17	130	1.00
6.0	.68	100	4.6	1.69	-42	-15.2	.173	4	.23	143	0.95

Note:

1. A model for this device is available in the DEVICE MODELS section.

Typical Performance, $T_A = 25^\circ\text{C}$

(unless otherwise noted)

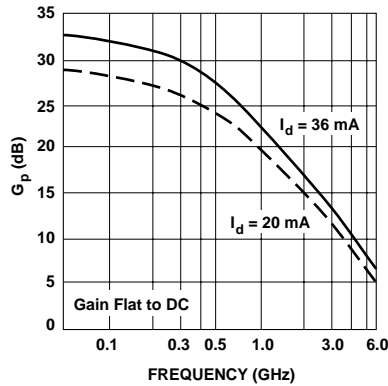

Figure 1. Typical Power Gain vs. Frequency, $I_d = 36 \text{ mA}$.

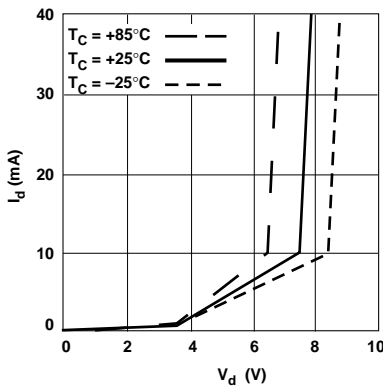

Figure 2. Device Current vs. Voltage.

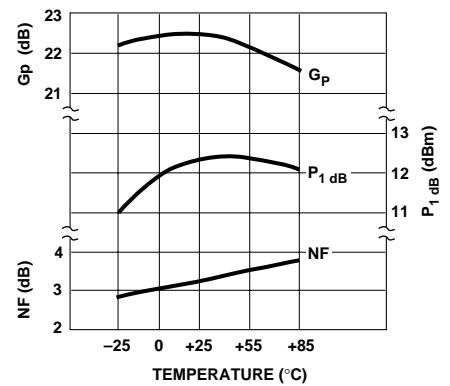

Figure 3. Output Power at 1 dB Gain Compression, NF and Power Gain vs. Case Temperature, $f = 1.0 \text{ GHz}$, $I_d = 36 \text{ mA}$.

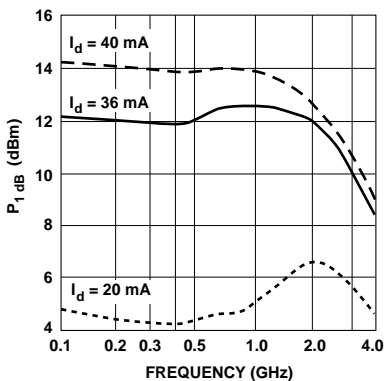

Figure 4. Output Power at 1 dB Gain Compression vs. Frequency.

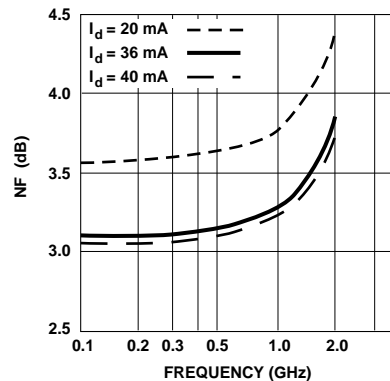
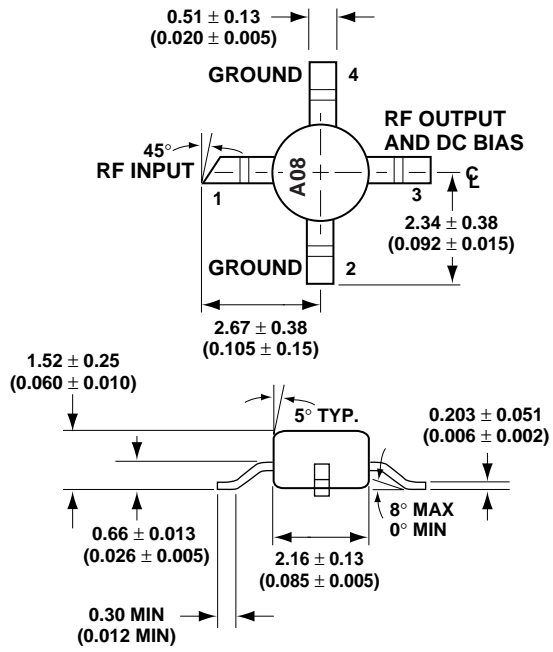

Figure 5. Noise Figure vs. Frequency.

86 Plastic Package Dimensions



DIMENSIONS ARE IN MILLIMETERS (INCHES)