

**20V(D-S) Dual N-Channel Enhancement Mode Power MOS FET**

**General Features**

- $V_{DS} = 20V, I_D = 7A$   
 $R_{DS(ON)} < 27m\Omega @ V_{GS} = 2.5V$   
 $R_{DS(ON)} < 21m\Omega @ V_{GS} = 4.5V$   
 ESD Rating: 2000V HBM
- High Power and current handling capability
- Lead free product is acquired
- Surface Mount Package
- ESD protected



**Lead Free**

**Application**

- PWM application
- Load switch

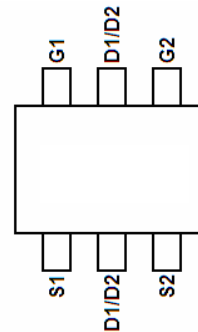

**Marking and pin assignment**

**PIN Configuration**

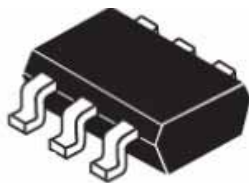

**SOT-23-6L top view**

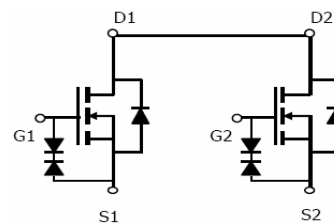

**Schematic diagram**

**Package Marking and Ordering Information**

Device Marking	Device	Device Package	Reel Size	Tape width	Quantity
MSC0207SE	MSC0207SE	SOT-23-6L	Ø330mm	12mm	3000 units

**Absolute Maximum Ratings ( $T_A = 25^\circ C$  unless otherwise noted)**

Parameter	Symbol	Limit	Unit
Drain-Source Voltage	$V_{DS}$	20	V
Gate-Source Voltage	$V_{GS}$	$\pm 12$	V
Drain Current-Continuous	$I_D$	7	A
Drain Current-Pulsed <sup>(Note 1)</sup>	$I_{DM}$	30	A
Maximum Power Dissipation	$P_D$	1.25	W
Operating Junction and Storage Temperature Range	$T_J, T_{STG}$	-55 To 150	$^\circ C$

**Thermal Characteristic**

Thermal Resistance, Junction-to-Ambient <sup>(Note 2)</sup>	$R_{\theta JA}$	100	$^\circ C/W$
---	-----------------	-----	--------------

**Electrical Characteristics (T<sub>A</sub>=25°C unless otherwise noted)**

Parameter	Symbol	Condition	Min	Typ	Max	Unit
<b>Off Characteristics</b>						
Drain-Source Breakdown Voltage	BV <sub>DSS</sub>	V <sub>GS</sub> =0V I <sub>D</sub> =250μA	20		-	V
Zero Gate Voltage Drain Current	I <sub>DSS</sub>	V <sub>DS</sub> =20V, V <sub>GS</sub> =0V	-	-	1	μA
Gate-Body Leakage Current	I <sub>GSS</sub>	V <sub>GS</sub> =±10V, V <sub>DS</sub> =0V	-	-	±10	μA
<b>On Characteristics</b> (Note 3)						
Gate Threshold Voltage	V <sub>GS(th)</sub>	V <sub>DS</sub> =V <sub>GS</sub> , I <sub>D</sub> =250μA	0.55	0.7	0.95	V
Drain-Source On-State Resistance	R <sub>DS(ON)</sub>	V <sub>GS</sub> =4.5V, I <sub>D</sub> =6.5A	-	15	21	mΩ
		V <sub>GS</sub> =2.5V, I <sub>D</sub> =5.5A	-	20	27	mΩ
Forward Transconductance	g <sub>FS</sub>	V <sub>DS</sub> =5V, I <sub>D</sub> =7A	-	20	-	S
<b>Dynamic Characteristics</b> (Note 4)						
Input Capacitance	C <sub>ISS</sub>	V <sub>DS</sub> =10V, V <sub>GS</sub> =0V, F=1.0MHz	-	1150	-	PF
Output Capacitance	C <sub>OSS</sub>		-	185	-	PF
Reverse Transfer Capacitance	C <sub>rss</sub>		-	145	-	PF
<b>Switching Characteristics</b> (Note 4)						
Turn-on Delay Time	t <sub>d(on)</sub>	V <sub>DD</sub> =10V, R <sub>L</sub> =1.35Ω V <sub>GS</sub> =5V, R <sub>GEN</sub> =3Ω	-	6		nS
Turn-on Rise Time	t <sub>r</sub>		-	13		nS
Turn-Off Delay Time	t <sub>d(off)</sub>		-	52		nS
Turn-Off Fall Time	t <sub>f</sub>		-	16		nS
Total Gate Charge	Q <sub>g</sub>	V <sub>DS</sub> =10V, I <sub>D</sub> =7A, V <sub>GS</sub> =4.5V	-	15		nC
Gate-Source Charge	Q <sub>gs</sub>		-	0.8	-	nC
Gate-Drain Charge	Q <sub>gd</sub>		-	3.2	-	nC
<b>Drain-Source Diode Characteristics</b>						
Diode Forward Voltage (Note 3)	V <sub>SD</sub>	V <sub>GS</sub> =0V, I <sub>S</sub> =1A	-	-	1.2	V
Diode Forward Current (Note 2)	I <sub>S</sub>		-	-	7	A

**Notes:**

1. Repetitive Rating: Pulse width limited by maximum junction temperature.
2. Surface Mounted on FR4 Board, t ≤ 10 sec.
3. Pulse Test: Pulse Width ≤ 300μs, Duty Cycle ≤ 2%.
4. Guaranteed by design, not subject to production

Typical Electrical and Thermal Characteristics

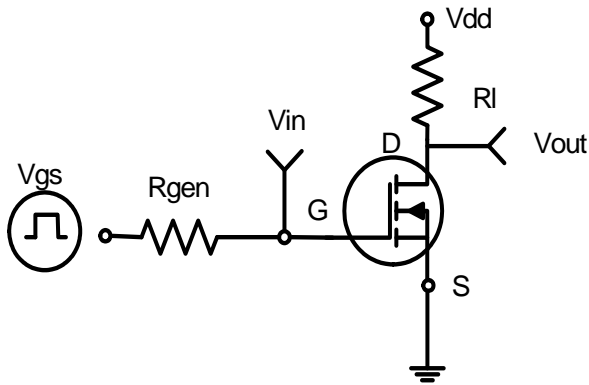

Figure 1: Switching Test Circuit

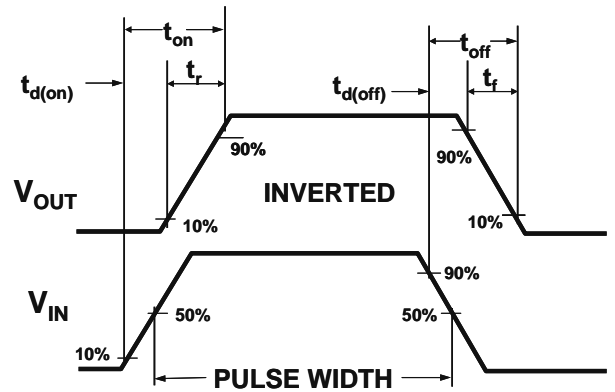

Figure 2: Switching Waveforms

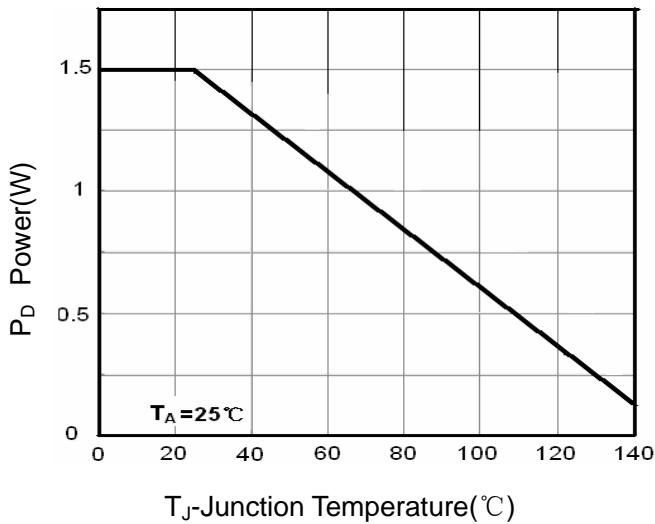

Figure 3 Power Dissipation

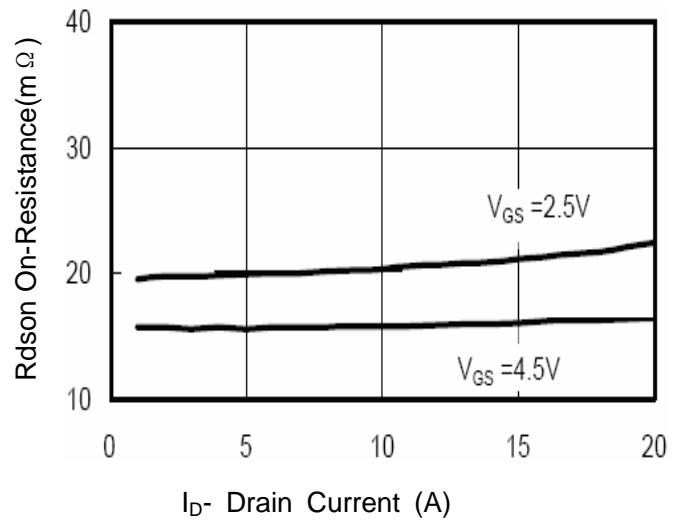

Figure 6 Drain-Source On-Resistance

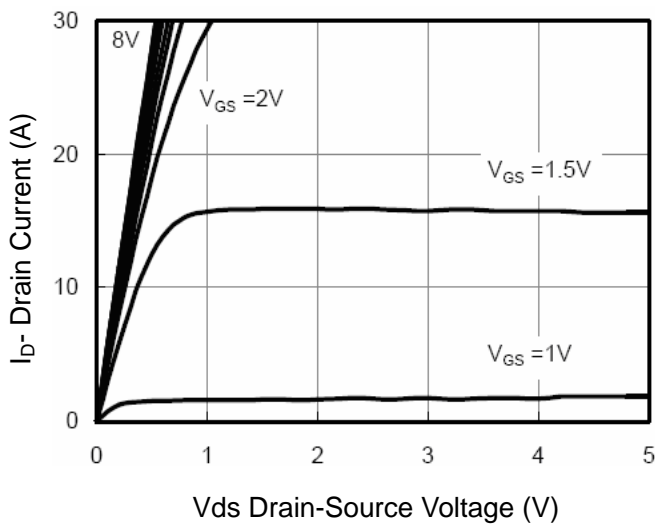

Figure 5 Output Characteristics

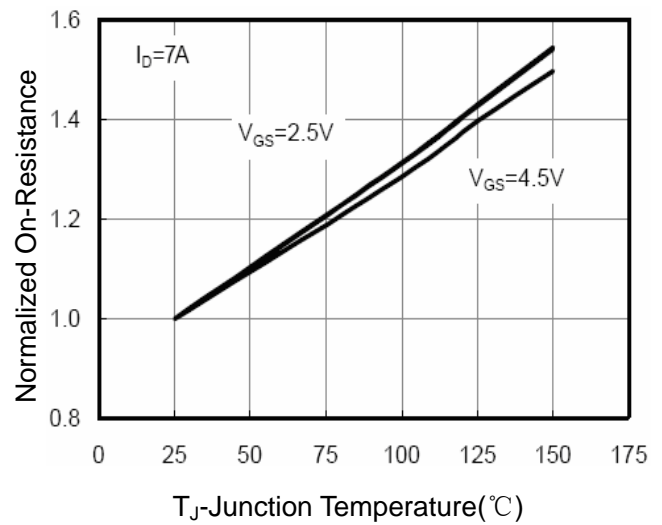
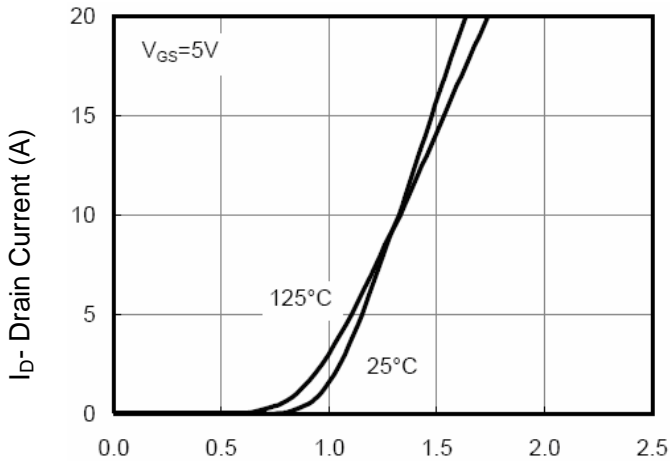
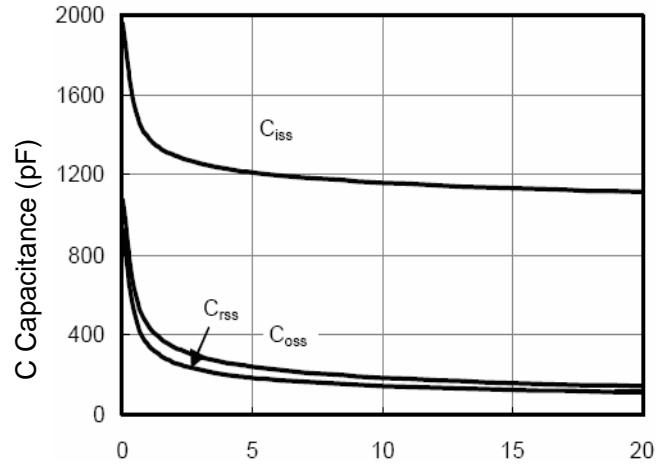

Figure 8 Drain-Source On-Resistance



Vgs Gate-Source Voltage (V)  
**Figure 7 Transfer Characteristics**



Vds Drain-Source Voltage (V)  
**Figure 8 Capacitance vs Vds**

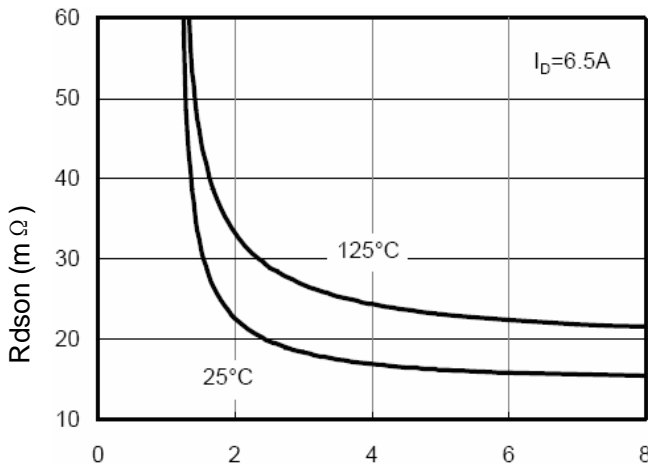

Vgs Gate-Source Voltage (V)  
**Figure 9 Rdson vs Vgs**

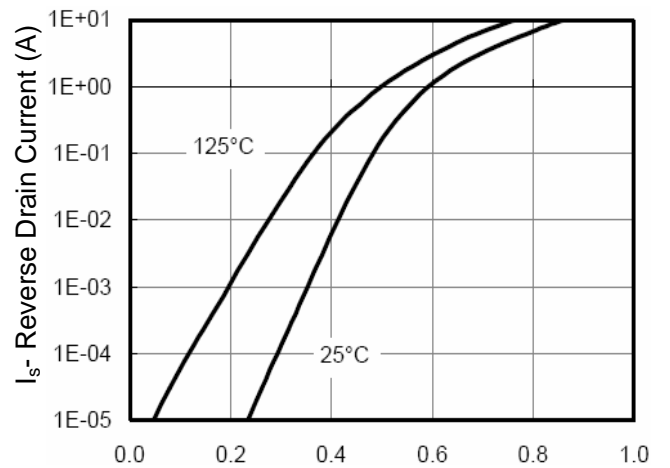

Vds Drain-Source Voltage (V)  
**Figure 10 Capacitance vs Vds**

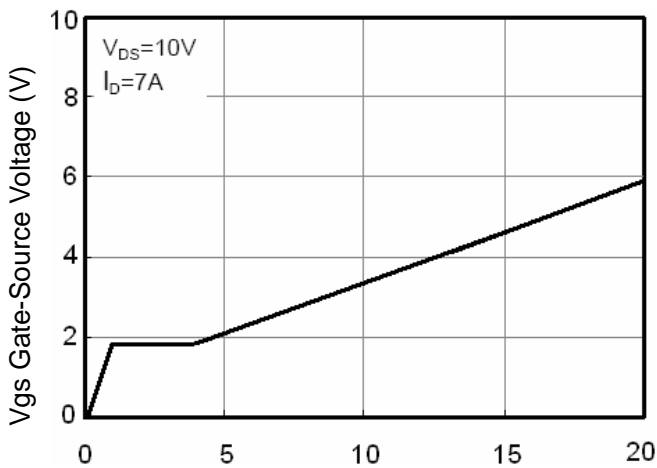

Qg Gate Charge (nC)  
**Figure 11 Gate Charge**

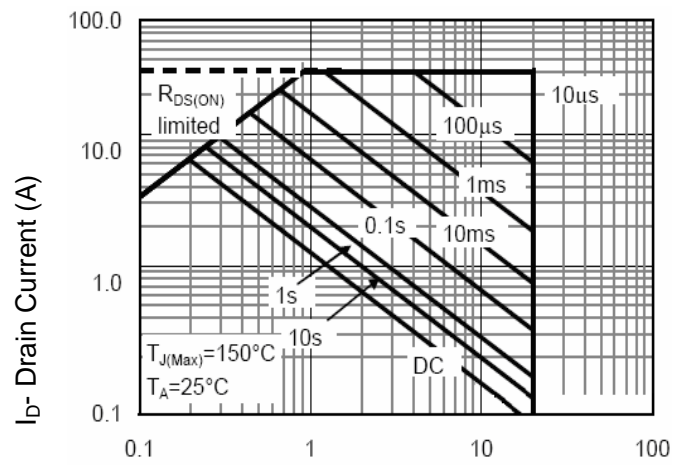

Vds Drain-Source Voltage (V)  
**Figure 13 Safe Operation Area**

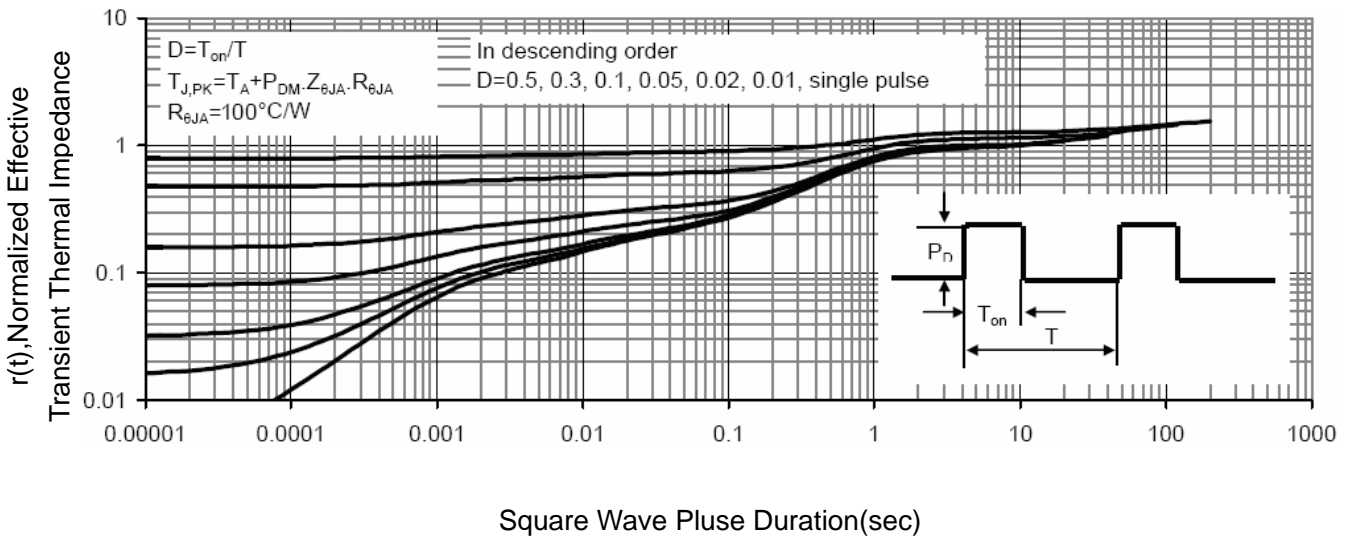

**Figure 14 Normalized Maximum Transient Thermal Impedance**

**SOT-23-6L Package Information**

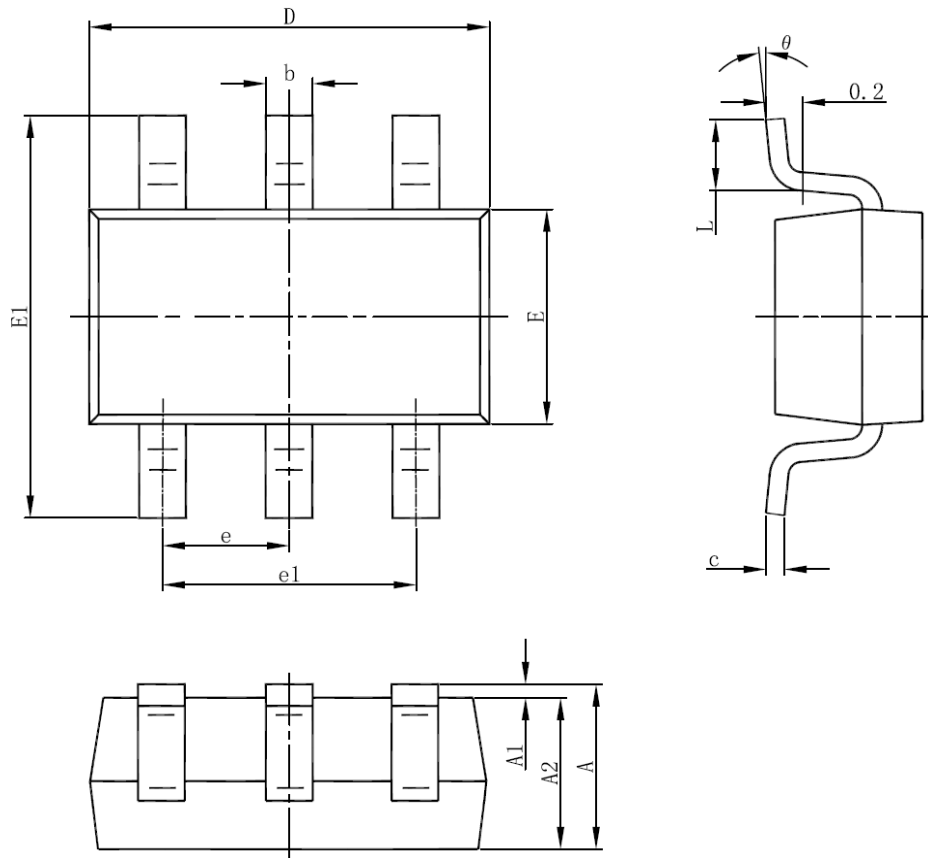

Symbol	Dimensions In Millimeters		Dimensions In Inches	
	Min	Max	Min	Max
A	1.050	1.250	0.041	0.049
A1	0.000	0.100	0.000	0.004
A2	1.050	1.150	0.041	0.045
b	0.300	0.500	0.012	0.020
c	0.100	0.200	0.004	0.008
D	2.820	3.020	0.111	0.119
E	1.500	1.700	0.059	0.067
E1	2.650	2.950	0.104	0.116
e	0.950(BSC)		0.037(BSC)	
e1	1.800	2.000	0.071	0.079
L	0.300	0.600	0.012	0.024
$\theta$	0°	8°	0°	8°