

---

## Zero Recovery Silicon Carbide Schottky Diode

---

### Product Overview

---

The silicon carbide (SiC) power Schottky barrier diode (SBD) product line from Microchip increases the performance over silicon diode solutions while lowering the total cost of ownership for high-voltage applications. The MSC030SDA330B device is a 3300 V, 30 A SiC SBD in a two-lead TO-247 package.

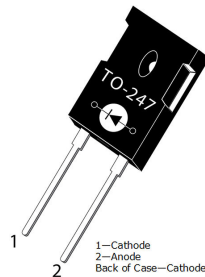

### Features

The following are key features of the MSC030SDA330B device:

- No reverse recovery
- Low forward voltage
- Low leakage current
- RoHS compliant

### Benefits

The following are benefits of the MSC030SDA330B device:

- High switching frequency
- Low switching losses
- Low noise (EMI) switching
- Higher reliability systems
- Increased system power density

### Applications

The MSC030SDA330B device is designed for the following applications:

- Power factor correction (PFC)
- Anti-parallel diode
  - Switch-mode power supply
  - Inverters/converters
  - Motor controllers
- Freewheeling diode
  - Switch-mode power supply
  - Inverters/converters
- Snubber/clamp diode

## 1. Device Specifications

This section shows the specifications of the MSC030SDA330B device.

### 1.1 Absolute Maximum Ratings

The following table shows the absolute maximum ratings of the MSC030SDA330B device.  $T_C = 25\text{ }^\circ\text{C}$  unless otherwise specified.

**Table 1-1. Absolute Maximum Ratings**

Symbol	Parameter	Ratings	Unit	
$V_R$	Maximum DC reverse voltage	3300	V	
$V_{RRM}$	Maximum peak repetitive reverse voltage			
$V_{RWM}$	Maximum working peak reverse voltage			
$I_F$	Maximum DC forward current	$T_C = 25\text{ }^\circ\text{C}$	62	A
		$T_C = 135\text{ }^\circ\text{C}$	30	
		$T_C = 145\text{ }^\circ\text{C}$	25	
$I_{FRM}$	Repetitive peak forward surge current ( $T_C = 25\text{ }^\circ\text{C}$ , $t_p = 8.3\text{ ms}$ , half sine wave)	93		
$I_{FSM}$	Non-repetitive forward surge current ( $T_C = 25\text{ }^\circ\text{C}$ , $t_p = 8.3\text{ ms}$ , half sine wave)	205		
$P_{TOT}$	Total power dissipation	$T_C = 25\text{ }^\circ\text{C}$	556	W
		$T_C = 110\text{ }^\circ\text{C}$	241	

The following table shows the thermal and mechanical characteristics of the MSC030SDA330B device.

**Table 1-2. Thermal and Mechanical Characteristics**

Symbol	Characteristic/Test Conditions	Min	Typ	Max	Unit
$R_{\theta JC}$	Junction-to-case thermal resistance		0.19	0.27	$^\circ\text{C}/\text{W}$
$T_J, T_{STG}$	Operating junction and storage temperature range	-55		175	$^\circ\text{C}$
$T_L$	Lead temperature for 10 seconds			300	
Wt	Package weight		0.22		oz
			6.2		g
	Mounting torque, 6-32 or M3 screw			10	lbf-in
				1.1	N-m

### 1.2 Electrical Performance

The following table shows the static characteristics of the MSC030SDA330B device.  $T_J = 25\text{ }^\circ\text{C}$  unless otherwise specified.

**Table 1-3. Static Characteristics**

Symbol	Characteristic	Test Conditions	Min	Typ	Max	Unit
$V_F$	Forward voltage	$I_F = 30\text{ A}$ , $T_J = 25\text{ }^\circ\text{C}$		2.1	2.4	V
		$I_F = 30\text{ A}$ , $T_J = 175\text{ }^\circ\text{C}$		4.6		
$I_{RM}$	Reverse leakage current	$V_R = 3300\text{ V}$ , $T_J = 25\text{ }^\circ\text{C}$		5	200	$\mu\text{A}$
		$V_R = 3300\text{ V}$ , $T_J = 175\text{ }^\circ\text{C}$		50		
$Q_C$	Total capacitive charge	$V_R = 1650\text{ V}$		274		nC
$C_J$	Junction capacitance	$V_R = 1\text{ V}$ , $f = 1\text{ MHz}$		1850		pF
		$V_R = 1100\text{ V}$ , $f = 1\text{ MHz}$		107		
		$V_R = 2200\text{ V}$ , $f = 1\text{ MHz}$		78		

### 1.3 Typical Performance Curves

This section shows the typical performance curves of the MSC030SDA330B device.

**Figure 1-1. Maximum Transient Thermal Impedance**

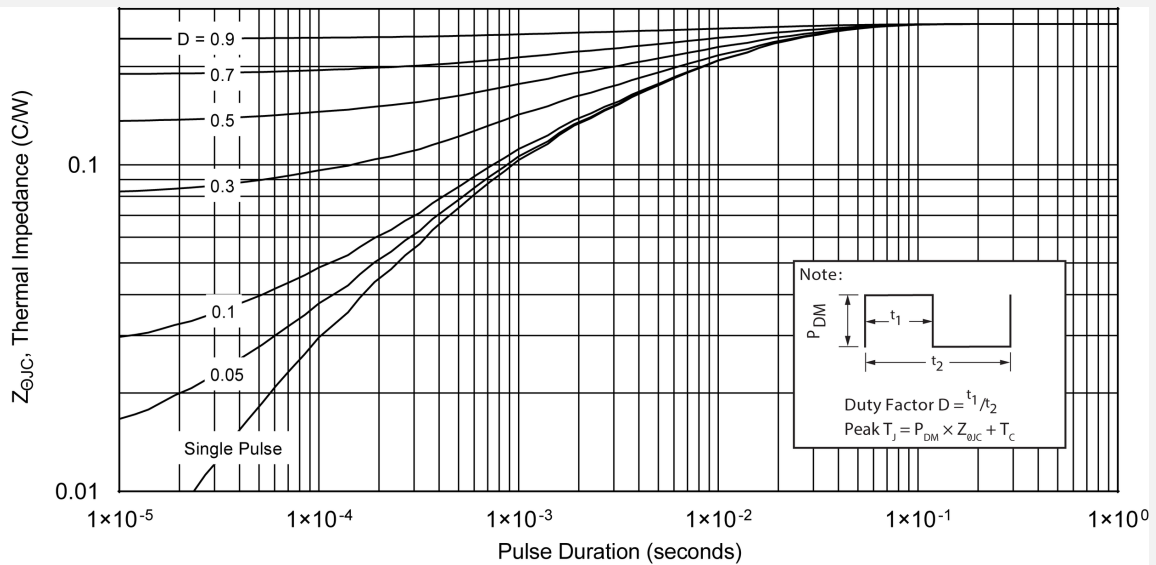

**Figure 1-2. Forward Current vs. Forward Voltage**

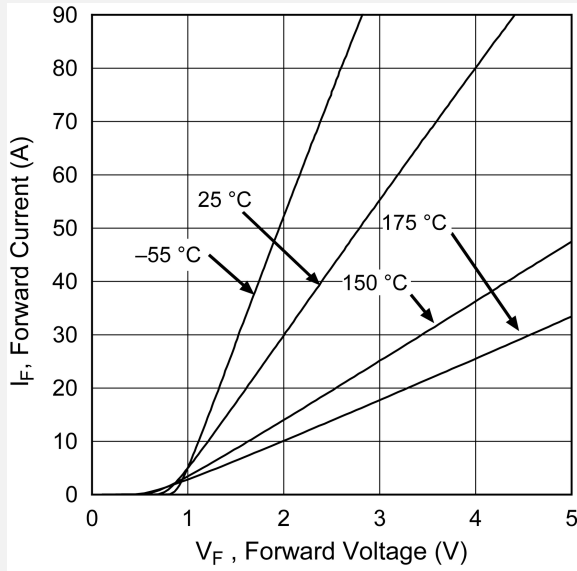

**Figure 1-3. Max. Forward Current vs. Case Temp.**

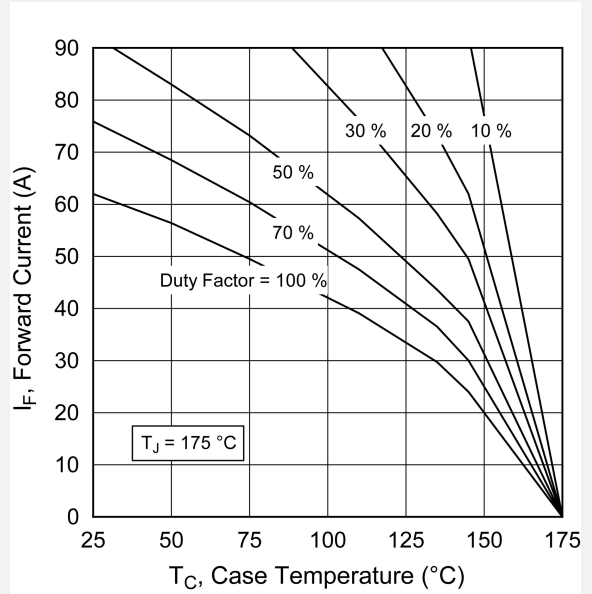

**Figure 1-4. Max. Power Dissipation vs. Case Temp.**

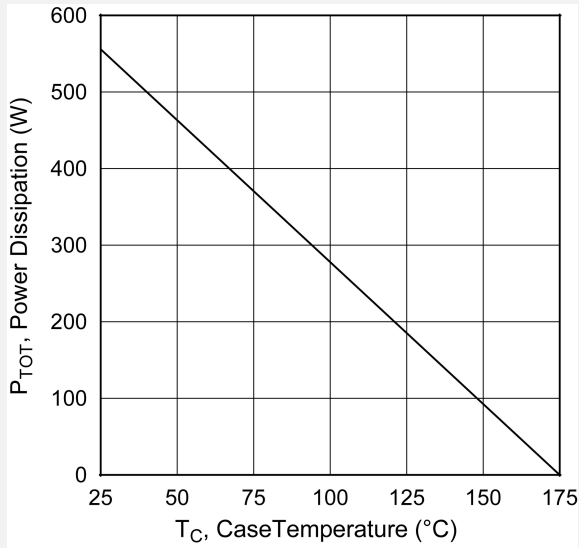

**Figure 1-5. Reverse Current vs. Reverse Voltage**

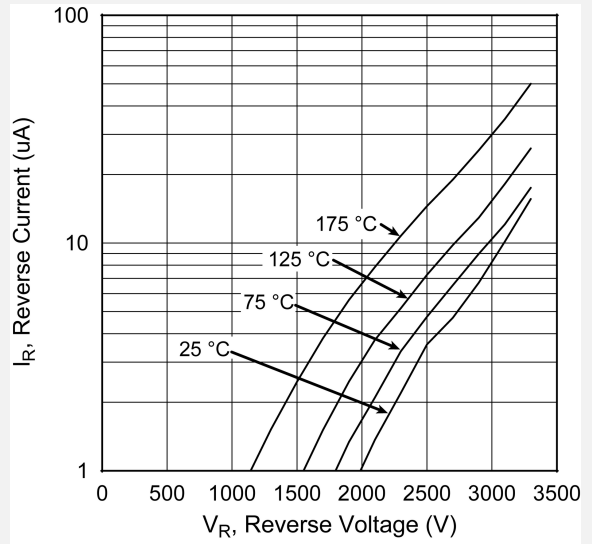

Figure 1-6. Total Charge vs. Reverse Voltage

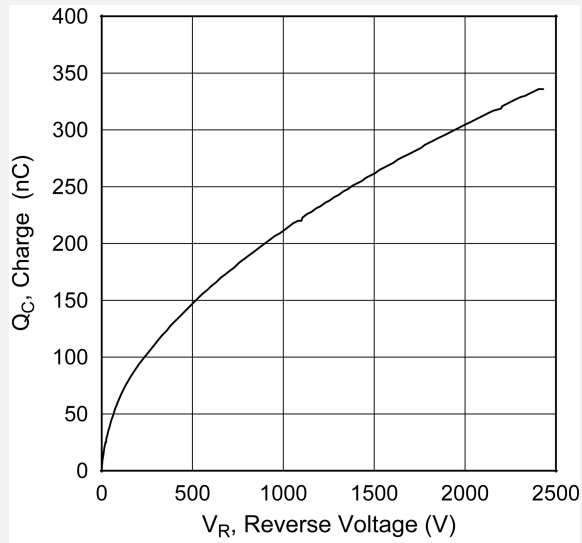
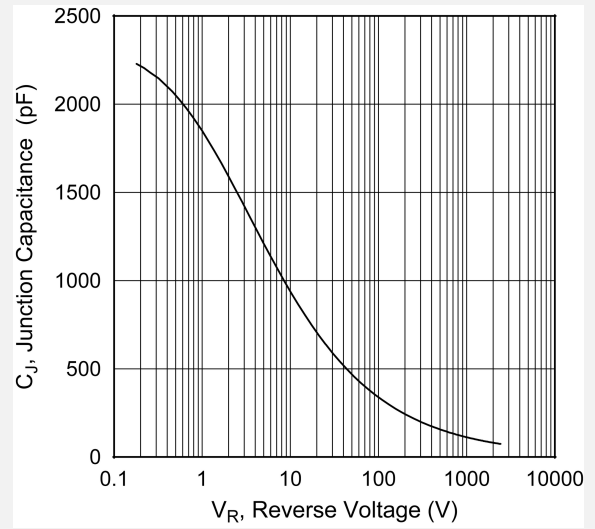

Figure 1-7. Capacitance vs. Reverse Voltage



## 2. Package Specification

This section shows the package specification of the MSC030SDA330B device.

### 2.1 Package Outline Drawing

The following figure illustrates the TO-247 package outline of the MSC030SDA330B device.

**Figure 2-1. Package Outline Drawing**

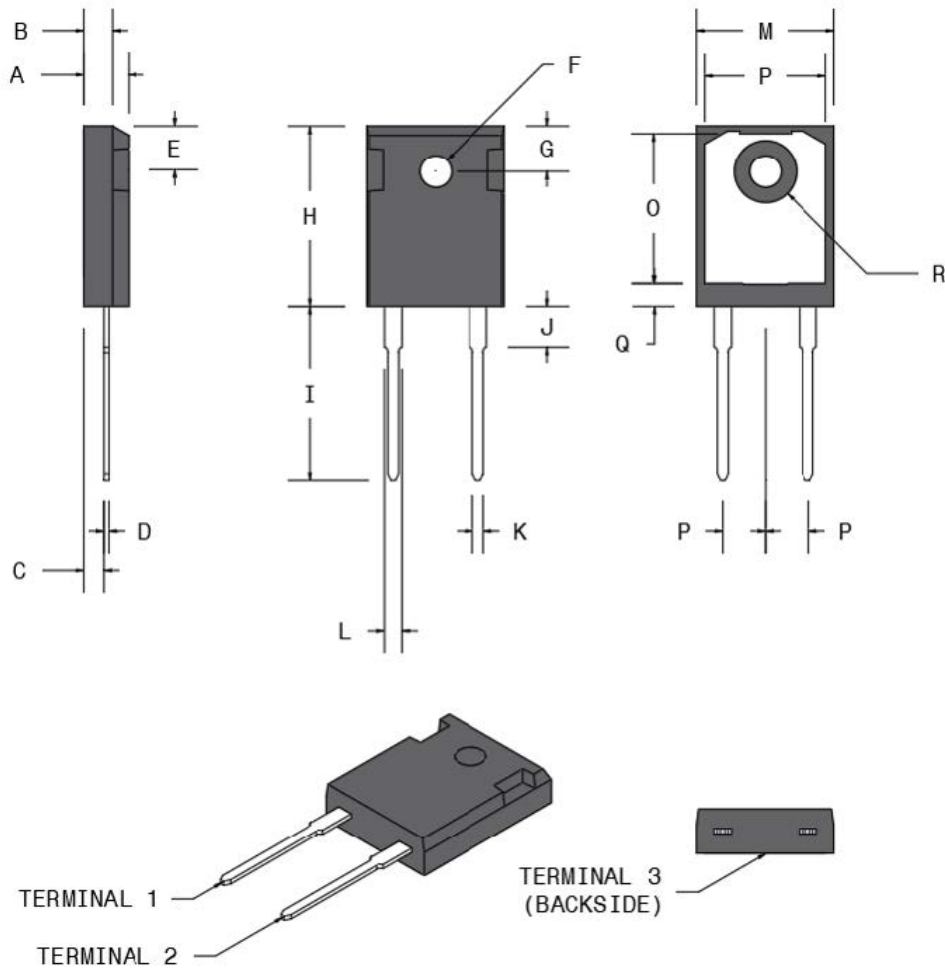

The following table shows the TO-247 dimensions and should be used in conjunction with the package outline drawing.

**Table 2-1. TO-247 Dimensions**

Symbol	Min (mm)	Max (mm)	Min (in.)	Max (in.)
A	4.69	5.31	0.185	0.209
B	1.49	2.49	0.059	0.098
C	2.21	2.59	0.087	0.102
D	0.40	0.79	0.016	0.031

# MSC030SDA330B

## Package Specification

.....continued				
Symbol	Min (mm)	Max (mm)	Min (in.)	Max (in.)
E	5.38	6.20	0.212	0.244
F	3.50	3.81	0.138	0.150
G	6.15 BSC		0.242 BSC	
H	20.80	21.46	0.819	0.845
I	19.81	20.32	0.780	0.800
J	4.00	4.50	0.157	0.177
K	1.01	1.40	0.040	0.055
L	1.65	2.13	0.065	0.084
M	15.49	16.26	0.610	0.640
N	13.50	14.50	0.531	0.571
O	16.50	17.50	0.650	0.689
P	5.45 BSC		0.215 BSC	
Q	2.00	2.75	0.079	0.108
R	7.10	7.50	0.280	0.295
Terminal 1	Cathode			
Terminal 2	Anode			
Terminal 3	Cathode			

### 3. **Revision History**

**Table 3-1. Revision History**

<b>Revision</b>	<b>Date</b>	<b>Description</b>
A	11/2021	Document created.



---

## The Microchip Website

---

Microchip provides online support via our website at [www.microchip.com/](http://www.microchip.com/). This website is used to make files and information easily available to customers. Some of the content available includes:

- **Product Support** – Data sheets and errata, application notes and sample programs, design resources, user's guides and hardware support documents, latest software releases and archived software
- **General Technical Support** – Frequently Asked Questions (FAQs), technical support requests, online discussion groups, Microchip design partner program member listing
- **Business of Microchip** – Product selector and ordering guides, latest Microchip press releases, listing of seminars and events, listings of Microchip sales offices, distributors and factory representatives

---

## Product Change Notification Service

---

Microchip's product change notification service helps keep customers current on Microchip products. Subscribers will receive email notification whenever there are changes, updates, revisions or errata related to a specified product family or development tool of interest.

To register, go to [www.microchip.com/pcn](http://www.microchip.com/pcn) and follow the registration instructions.

---

## Customer Support

---

Users of Microchip products can receive assistance through several channels:

- Distributor or Representative
- Local Sales Office
- Embedded Solutions Engineer (ESE)
- Technical Support

Customers should contact their distributor, representative or ESE for support. Local sales offices are also available to help customers. A listing of sales offices and locations is included in this document.

Technical support is available through the website at: [www.microchip.com/support](http://www.microchip.com/support)

---

## Microchip Devices Code Protection Feature

---

Note the following details of the code protection feature on Microchip devices:

- Microchip products meet the specifications contained in their particular Microchip Data Sheet.
- Microchip believes that its family of products is secure when used in the intended manner and under normal conditions.
- There are dishonest and possibly illegal methods being used in attempts to breach the code protection features of the Microchip devices. We believe that these methods require using the Microchip products in a manner outside the operating specifications contained in Microchip's Data Sheets. Attempts to breach these code protection features, most likely, cannot be accomplished without violating Microchip's intellectual property rights.
- Microchip is willing to work with any customer who is concerned about the integrity of its code.
- Neither Microchip nor any other semiconductor manufacturer can guarantee the security of its code. Code protection does not mean that we are guaranteeing the product is "unbreakable." Code protection is constantly evolving. We at Microchip are committed to continuously improving the code protection features of our products. Attempts to break Microchip's code protection feature may be a violation of the Digital Millennium Copyright Act. If such acts allow unauthorized access to your software or other copyrighted work, you may have a right to sue for relief under that Act.

---

## Legal Notice

---

Information contained in this publication is provided for the sole purpose of designing with and using Microchip products. Information regarding device applications and the like is provided only for your convenience and may be superseded by updates. It is your responsibility to ensure that your application meets with your specifications.

THIS INFORMATION IS PROVIDED BY MICROCHIP "AS IS". MICROCHIP MAKES NO REPRESENTATIONS OR WARRANTIES OF ANY KIND WHETHER EXPRESS OR IMPLIED, WRITTEN OR ORAL, STATUTORY OR OTHERWISE, RELATED TO THE INFORMATION INCLUDING BUT NOT LIMITED TO ANY IMPLIED WARRANTIES OF NON-INFRINGEMENT, MERCHANTABILITY, AND FITNESS FOR A PARTICULAR PURPOSE OR WARRANTIES RELATED TO ITS CONDITION, QUALITY, OR PERFORMANCE.

IN NO EVENT WILL MICROCHIP BE LIABLE FOR ANY INDIRECT, SPECIAL, PUNITIVE, INCIDENTAL OR CONSEQUENTIAL LOSS, DAMAGE, COST OR EXPENSE OF ANY KIND WHATSOEVER RELATED TO THE INFORMATION OR ITS USE, HOWEVER CAUSED, EVEN IF MICROCHIP HAS BEEN ADVISED OF THE POSSIBILITY OR THE DAMAGES ARE FORESEEABLE. TO THE FULLEST EXTENT ALLOWED BY LAW, MICROCHIP'S TOTAL LIABILITY ON ALL CLAIMS IN ANY WAY RELATED TO THE INFORMATION OR ITS USE WILL NOT EXCEED THE AMOUNT OF FEES, IF ANY, THAT YOU HAVE PAID DIRECTLY TO MICROCHIP FOR THE INFORMATION. Use of Microchip devices in life support and/or safety applications is entirely at the buyer's risk, and the buyer agrees to defend, indemnify and hold harmless Microchip from any and all damages, claims, suits, or expenses resulting from such use. No licenses are conveyed, implicitly or otherwise, under any Microchip intellectual property rights unless otherwise stated.

---

## Trademarks

---

The Microchip name and logo, the Microchip logo, Adaptec, AnyRate, AVR, AVR logo, AVR Freaks, BesTime, BitCloud, chipKIT, chipKIT logo, CryptoMemory, CryptoRF, dsPIC, FlashFlex, flexPWR, HELDO, IGLOO, JukeBlox, KeeLoq, Klear, LANCheck, LinkMD, maXStylus, maXTouch, MediaLB, megaAVR, Microsemi, Microsemi logo, MOST, MOST logo, MPLAB, OptoLyzer, PackeTime, PIC, picoPower, PICSTART, PIC32 logo, PolarFire, Prochip Designer, QTouch, SAM-BA, SenGenuity, SpyNIC, SST, SST Logo, SuperFlash, Symmetricom, SyncServer, Tachyon, TimeSource, tinyAVR, UNI/O, Vectron, and XMEGA are registered trademarks of Microchip Technology Incorporated in the U.S.A. and other countries.

AgileSwitch, APT, ClockWorks, The Embedded Control Solutions Company, EtherSynch, FlashTec, Hyper Speed Control, HyperLight Load, IntelliMOS, Libero, motorBench, mTouch, Powermite 3, Precision Edge, ProASIC, ProASIC Plus, ProASIC Plus logo, Quiet-Wire, SmartFusion, SyncWorld, Temux, TimeCesium, TimeHub, TimePictra, TimeProvider, WinPath, and ZL are registered trademarks of Microchip Technology Incorporated in the U.S.A.

Adjacent Key Suppression, AKS, Analog-for-the-Digital Age, Any Capacitor, AnyIn, AnyOut, Augmented Switching, BlueSky, BodyCom, CodeGuard, CryptoAuthentication, CryptoAutomotive, CryptoCompanion, CryptoController, dsPICDEM, dsPICDEM.net, Dynamic Average Matching, DAM, ECAN, Espresso T1S, EtherGREEN, IdealBridge, In-Circuit Serial Programming, ICSP, INICnet, Intelligent Paralleling, Inter-Chip Connectivity, JitterBlocker, maxCrypto, maxView, memBrain, Mindi, MiWi, MPASM, MPF, MPLAB Certified logo, MPLIB, MPLINK, MultiTRAK, NetDetach, Omniscient Code Generation, PICDEM, PICDEM.net, PICKit, PICtail, PowerSmart, PureSilicon, QMatrix, REAL ICE, Ripple Blocker, RTAX, RTG4, SAM-ICE, Serial Quad I/O, simpleMAP, SimpliPHY, SmartBuffer, SMART-I.S., storClad, SQL, SuperSwitcher, SuperSwitcher II, Switchtec, SynchroPHY, Total Endurance, TSHARC, USBCheck, VariSense, VectorBlox, VeriPHY, ViewSpan, WiperLock, XpressConnect, and ZENA are trademarks of Microchip Technology Incorporated in the U.S.A. and other countries.

SQTP is a service mark of Microchip Technology Incorporated in the U.S.A.

The Adaptec logo, Frequency on Demand, Silicon Storage Technology, and Symmcom are registered trademarks of Microchip Technology Inc. in other countries.

GestIC is a registered trademark of Microchip Technology Germany II GmbH & Co. KG, a subsidiary of Microchip Technology Inc., in other countries.

All other trademarks mentioned herein are property of their respective companies.

© 2021, Microchip Technology Incorporated, Printed in the U.S.A., All Rights Reserved.

ISBN: 978-1-5224-9152-1

## **Quality Management System**

---

For information regarding Microchip's Quality Management Systems, please visit [www.microchip.com/quality](http://www.microchip.com/quality).

## Worldwide Sales and Service

AMERICAS	ASIA/PACIFIC	ASIA/PACIFIC	EUROPE
<p><b>Corporate Office</b> 2355 West Chandler Blvd. Chandler, AZ 85224-6199 Tel: 480-792-7200 Tel: 480-792-7277 Technical Support: <a href="http://www.microchip.com/support">www.microchip.com/support</a> Web Address: <a href="http://www.microchip.com">www.microchip.com</a></p> <p><b>Atlanta</b> Duluth, GA Tel: 678-957-9614 Fax: 678-957-1455</p> <p><b>Austin, TX</b> Tel: 512-257-3370</p> <p><b>Boston</b> Westborough, MA Tel: 774-760-0087 Fax: 774-760-0088</p> <p><b>Chicago</b> Itasca, IL Tel: 630-285-0071 Fax: 630-285-0075</p> <p><b>Dallas</b> Addison, TX Tel: 972-818-7423 Fax: 972-818-2924</p> <p><b>Detroit</b> Novi, MI Tel: 248-848-4000</p> <p><b>Houston, TX</b> Tel: 281-894-5983</p> <p><b>Indianapolis</b> Noblesville, IN Tel: 317-773-8323 Fax: 317-773-5453 Tel: 317-536-2380</p> <p><b>Los Angeles</b> Mission Viejo, CA Tel: 949-462-9523 Fax: 949-462-9608 Tel: 951-273-7800</p> <p><b>Raleigh, NC</b> Tel: 919-844-7510</p> <p><b>New York, NY</b> Tel: 631-435-6000</p> <p><b>San Jose, CA</b> Tel: 408-735-9110 Tel: 408-436-4270</p> <p><b>Canada - Toronto</b> Tel: 905-695-1980 Fax: 905-695-2078</p>	<p><b>Australia - Sydney</b> Tel: 61-2-9868-6733</p> <p><b>China - Beijing</b> Tel: 86-10-8569-7000</p> <p><b>China - Chengdu</b> Tel: 86-28-8665-5511</p> <p><b>China - Chongqing</b> Tel: 86-23-8980-9588</p> <p><b>China - Dongguan</b> Tel: 86-769-8702-9880</p> <p><b>China - Guangzhou</b> Tel: 86-20-8755-8029</p> <p><b>China - Hangzhou</b> Tel: 86-571-8792-8115</p> <p><b>China - Hong Kong SAR</b> Tel: 852-2943-5100</p> <p><b>China - Nanjing</b> Tel: 86-25-8473-2460</p> <p><b>China - Qingdao</b> Tel: 86-532-8502-7355</p> <p><b>China - Shanghai</b> Tel: 86-21-3326-8000</p> <p><b>China - Shenyang</b> Tel: 86-24-2334-2829</p> <p><b>China - Shenzhen</b> Tel: 86-755-8864-2200</p> <p><b>China - Suzhou</b> Tel: 86-186-6233-1526</p> <p><b>China - Wuhan</b> Tel: 86-27-5980-5300</p> <p><b>China - Xian</b> Tel: 86-29-8833-7252</p> <p><b>China - Xiamen</b> Tel: 86-592-2388138</p> <p><b>China - Zhuhai</b> Tel: 86-756-3210040</p>	<p><b>India - Bangalore</b> Tel: 91-80-3090-4444</p> <p><b>India - New Delhi</b> Tel: 91-11-4160-8631</p> <p><b>India - Pune</b> Tel: 91-20-4121-0141</p> <p><b>Japan - Osaka</b> Tel: 81-6-6152-7160</p> <p><b>Japan - Tokyo</b> Tel: 81-3-6880-3770</p> <p><b>Korea - Daegu</b> Tel: 82-53-744-4301</p> <p><b>Korea - Seoul</b> Tel: 82-2-554-7200</p> <p><b>Malaysia - Kuala Lumpur</b> Tel: 60-3-7651-7906</p> <p><b>Malaysia - Penang</b> Tel: 60-4-227-8870</p> <p><b>Philippines - Manila</b> Tel: 63-2-634-9065</p> <p><b>Singapore</b> Tel: 65-6334-8870</p> <p><b>Taiwan - Hsin Chu</b> Tel: 886-3-577-8366</p> <p><b>Taiwan - Kaohsiung</b> Tel: 886-7-213-7830</p> <p><b>Taiwan - Taipei</b> Tel: 886-2-2508-8600</p> <p><b>Thailand - Bangkok</b> Tel: 66-2-694-1351</p> <p><b>Vietnam - Ho Chi Minh</b> Tel: 84-28-5448-2100</p>	<p><b>Austria - Wels</b> Tel: 43-7242-2244-39 Fax: 43-7242-2244-393</p> <p><b>Denmark - Copenhagen</b> Tel: 45-4485-5910 Fax: 45-4485-2829</p> <p><b>Finland - Espoo</b> Tel: 358-9-4520-820</p> <p><b>France - Paris</b> Tel: 33-1-69-53-63-20 Fax: 33-1-69-30-90-79</p> <p><b>Germany - Garching</b> Tel: 49-8931-9700</p> <p><b>Germany - Haan</b> Tel: 49-2129-3766400</p> <p><b>Germany - Heilbronn</b> Tel: 49-7131-72400</p> <p><b>Germany - Karlsruhe</b> Tel: 49-721-625370</p> <p><b>Germany - Munich</b> Tel: 49-89-627-144-0 Fax: 49-89-627-144-44</p> <p><b>Germany - Rosenheim</b> Tel: 49-8031-354-560</p> <p><b>Israel - Ra'anana</b> Tel: 972-9-744-7705</p> <p><b>Italy - Milan</b> Tel: 39-0331-742611 Fax: 39-0331-466781</p> <p><b>Italy - Padova</b> Tel: 39-049-7625286</p> <p><b>Netherlands - Drunen</b> Tel: 31-416-690399 Fax: 31-416-690340</p> <p><b>Norway - Trondheim</b> Tel: 47-72884388</p> <p><b>Poland - Warsaw</b> Tel: 48-22-3325737</p> <p><b>Romania - Bucharest</b> Tel: 40-21-407-87-50</p> <p><b>Spain - Madrid</b> Tel: 34-91-708-08-90 Fax: 34-91-708-08-91</p> <p><b>Sweden - Gothenberg</b> Tel: 46-31-704-60-40</p> <p><b>Sweden - Stockholm</b> Tel: 46-8-5090-4654</p> <p><b>UK - Wokingham</b> Tel: 44-118-921-5800 Fax: 44-118-921-5820</p>