

T-Type SiC MOSFET Power Module

Product Overview

The MSCSM120HRM163AG device is a T-type Silicon Carbide (SiC) MOSFET power module with a phase leg 1200V, 173A and a dual common source 700V, 124A.

The following figures show the electrical and pinout location diagrams of the device.

Figure 1. Electrical Diagram

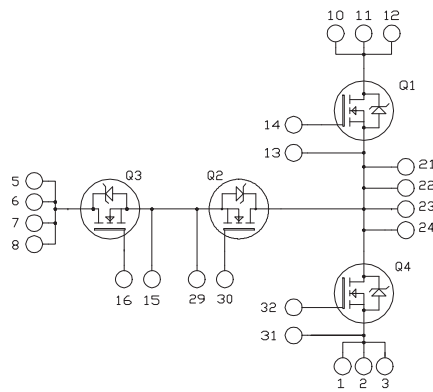
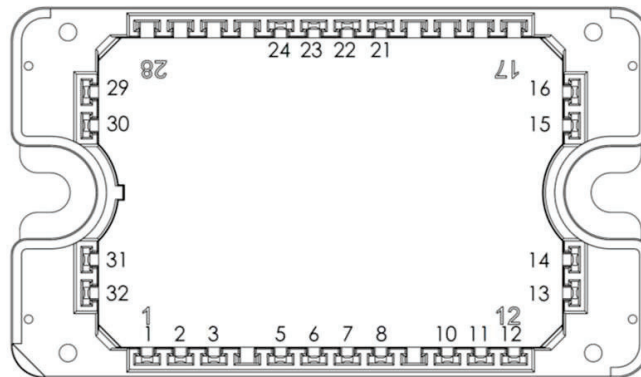

Figure 2. Pinout Location Diagram



Notes:

- Pins 1/2/3; 10/11/12; 5/6/7/8; 21/22/23/24 must be shorted together.
- All ratings at $T_J = 25\text{ }^\circ\text{C}$, unless otherwise specified.



These devices are sensitive to electrostatic discharge. Proper handling procedures must be followed.

Features

The MSCSM120HRM163AG device has the following features:

- SiC Power MOSFET
 - High speed switching
 - Low $R_{DS(on)}$
 - Ultra low loss
- Very low stray inductance
- Kelvin source for easy drive
- AlN substrate for improved thermal performance

Benefits

The MSCSM120HRM163AG device has the following benefits:

- Outstanding performance at high-frequency operation
- High-power and high-efficiency rectifiers and converters
- Direct mounting to heatsink (isolated package)
- Low junction-to-case thermal resistance
- Solderable terminals both for power and signal for easy PCB mounting
- Low profile
- RoHS compliant

Applications

The MSCSM120HRM163AG device has the following applications:

- Solar inverter
- Three level inverter
- Uninterruptible power supplies

1. Electrical Specifications

The following sections describe the electrical specifications of the MSCSM120HRM163AG device.

1.1 Q1 and Q4 1200V Phase Leg SiC MOSFETs Characteristics (Per SiC MOSFET)

The following table lists the absolute maximum ratings (per SiC MOSFET) of the Q1 and Q4 1200V phase leg SiC MOSFETs.

Table 1-1. Absolute Maximum Ratings: Q1 and Q4 1200V Phase Leg SiC MOSFETs

Symbol	Parameter	Maximum Ratings	Unit
V_{DSS}	Drain-source voltage	1200	V
I_D	Continuous drain current	$T_C = 25\text{ }^\circ\text{C}$	173
		$T_C = 80\text{ }^\circ\text{C}$	138
I_{DM}	Pulsed drain current	350	
V_{GS}	Gate-source voltage	-10/23	V
$R_{DS(on)}$	Drain-source ON resistance	16	m Ω
P_D	Power dissipation	$T_C = 25\text{ }^\circ\text{C}$	745

The following table lists the electrical characteristics (per SiC MOSFET) of the Q1 and Q4 1200V phase leg SiC MOSFETs.

Table 1-2. Electrical Characteristics: Q1 and Q4 1200V Phase Leg SiC MOSFETs

Symbol	Characteristic	Test Conditions	Min.	Typ.	Max.	Unit	
I_{DSS}	Zero gate voltage drain current	$V_{GS} = 0V; V_{DS} = 1200V$	—	20	200	μA	
$R_{DS(on)}$	Drain-source ON resistance	$V_{GS} = 20V$ $I_D = 80A$	$T_J = 25\text{ }^\circ\text{C}$	—	12.5	16	m Ω
			$T_J = 175\text{ }^\circ\text{C}$	—	20	—	
$V_{GS(th)}$	Gate threshold voltage	$V_{GS} = V_{DS}; I_D = 6\text{ mA}$	1.8	2.8	—	V	
I_{GSS}	Gate-source leakage current	$V_{GS} = 20V; V_{DS} = 0V$	—	—	200	nA	

The following table lists the dynamic characteristics (per SiC MOSFET) of the Q1 and Q4 1200V phase leg SiC MOSFETs.

Table 1-3. Dynamic Characteristics: Q1 and Q4 1200V Phase Leg SiC MOSFETs

Symbol	Characteristic	Test Conditions	Min.	Typ.	Max.	Unit
C_{iss}	Input capacitance	$V_{GS} = 0V$	—	6040	—	pF
C_{oss}	Output capacitance	$V_{DS} = 1000V$	—	540	—	
C_{rss}	Reverse transfer capacitance	$f = 1\text{ MHz}$	—	50	—	
Q_g	Total gate charge	$V_{GS} = -5V/20V$	—	464	—	nC
Q_{gs}	Gate-source charge	$V_{Bus} = 800V$	—	82	—	
Q_{gd}	Gate-drain charge	$I_D = 80A$	—	100	—	
$T_{d(on)}$	Turn-on delay time	$V_{GS} = -5V/20V$	—	30	—	ns
T_r	Rise time	$V_{Bus} = 600V$				
$T_{d(off)}$	Turn-off delay time	$I_D = 100A$				
T_f	Fall time	$R_{GON} = 4\Omega$ $R_{GOFF} = 2.4\Omega$				
E_{on}	Turn-on energy	$V_{GS} = -5V/20V$	—	2.4	—	mJ
E_{off}	Turn-off energy	$V_{Bus} = 600V$ $I_D = 100A$ $R_{GON} = 4\Omega$ $R_{GOFF} = 2.4\Omega$				
R_{Gint}	Internal gate resistance		—	2.94	—	Ω
R_{thJC}	Junction-to-case thermal resistance		—	—	0.2	$^{\circ}C/W$

The following table lists the body diode ratings and characteristics (per SiC MOSFET) of the Q1 and Q4 1200V phase leg SiC MOSFETs.

Table 1-4. Body Diode Ratings and Characteristics: Q1 and Q4 1200V Phase Leg SiC MOSFETs

Symbol	Characteristic	Test Conditions	Min.	Typ.	Max.	Unit
V_{SD}	Diode forward voltage	$V_{GS} = 0V; I_{SD} = 80A$	—	4	—	V
		$V_{GS} = -5V; I_{SD} = 80A$	—	4.2	—	
t_{rr}	Reverse recovery time	$I_{SD} = 80A$	—	90	—	ns
Q_{rr}	Reverse recovery charge	$V_{GS} = -5V$	—	1100	—	nC
I_{rr}	Reverse recovery current	$V_R = 800V$ $di_F/dt = 2000\text{ A}/\mu\text{s}$	—	27	—	A

1.2 Q2 and Q3 700V Dual Common Source SiC MOSFETs Characteristics (Per SiC MOSFET)

The following table lists the absolute maximum ratings (per SiC MOSFET) of the Q2 and Q3 700V dual common source SiC MOSFETs.

Table 1-5. Absolute Maximum Ratings: Q2 and Q3 700V Dual Common Source SiC MOSFETs

Symbol	Parameter	Maximum Ratings	Unit
V_{DSS}	Drain-source voltage	700	V
I_D	Continuous drain current	$T_C = 25\text{ }^\circ\text{C}$	124
		$T_C = 80\text{ }^\circ\text{C}$	98
I_{DM}	Pulsed drain current	250	
V_{GS}	Gate-source voltage	-10/23	V
$R_{DS(on)}$	Drain-source ON resistance	19	m Ω
P_D	Power dissipation	$T_C = 25\text{ }^\circ\text{C}$	365
			W

The following table lists the electrical characteristics (per SiC MOSFET) of the Q2 and Q3 700V dual common source SiC MOSFETs.

Table 1-6. Electrical Characteristics: Q2 and Q3 700V Dual Common Source SiC MOSFETs

Symbol	Characteristic	Test Conditions	Min.	Typ.	Max.	Unit
I_{DSS}	Zero gate voltage drain current	$V_{GS} = 0V; V_{DS} = 700V$	—	—	100	μA
$R_{DS(on)}$	Drain-source ON resistance	$V_{GS} = 20V$	—	15	19	m Ω
		$I_D = 40A$		18.8	—	
$V_{GS(th)}$	Gate threshold voltage	$V_{GS} = V_{DS}; I_D = 4\text{ mA}$	1.9	2.4	—	V
I_{GSS}	Gate-source leakage current	$V_{GS} = 20V; V_{DS} = 0V$	—	—	150	nA

The following table lists the dynamic characteristics (per SiC MOSFET) of the Q2 and Q3 700V dual common source SiC MOSFETs.

Table 1-7. Dynamic Characteristics: Q2 and Q3 700V Dual Common Source SiC MOSFETs

Symbol	Characteristic	Test Conditions	Min.	Typ.	Max.	Unit
C_{iss}	Input capacitance	$V_{GS} = 0V$	—	4500	—	pF
C_{oss}	Output capacitance	$V_{DS} = 700V$	—	510	—	
C_{rss}	Reverse transfer capacitance	$f = 1\text{ MHz}$	—	29	—	
Q_g	Total gate charge	$V_{GS} = -5V/20V$	—	215	—	nC
Q_{gs}	Gate-source charge	$V_{Bus} = 470V$	—	58	—	
Q_{gd}	Gate-drain charge	$I_D = 40A$	—	35	—	
$T_{d(on)}$	Turn-on delay time	$V_{GS} = -5V/20V$	—	40	—	ns
T_r	Rise time	$V_{Bus} = 400V$				
$T_{d(off)}$	Turn-off delay time	$I_D = 80A$				
T_f	Fall time	$R_{GON} = 68\Omega$ $R_{GOFF} = 4.7\Omega$				
E_{on}	Turn-on energy	$V_{GS} = -5V/20V$	—	893	—	μJ
E_{off}	Turn-off energy	$V_{Bus} = 400V$ $I_D = 80A$ $R_{GON} = 68\Omega$ $R_{GOFF} = 4.7\Omega$				
R_{Gint}	Internal gate resistance		—	0.69	—	Ω
R_{thJC}	Junction-to-case thermal resistance		—	—	0.41	$^{\circ}C/W$

The following table lists the body diode ratings and characteristics (per SiC MOSFET) of the Q2 and Q3 700V dual common source SiC MOSFETs.

Table 1-8. Body Diode Ratings and Characteristics: Q2 and Q3 700V Dual Common Source SiC MOSFETs

Symbol	Characteristic	Test Conditions	Min.	Typ.	Max.	Unit
V_{SD}	Diode forward voltage	$V_{GS} = 0V; I_{SD} = 40A$	—	3.4	—	V
		$V_{GS} = -5V; I_{SD} = 40A$	—	3.8	—	
t_{rr}	Reverse recovery time	$I_{SD} = 40A$	—	38	—	ns
Q_{rr}	Reverse recovery charge	$V_{GS} = -5V$	—	318	—	nC
I_{rr}	Reverse recovery current	$V_R = 400V$ $di_F/dt = 1000\text{ A}/\mu s$	—	14.8	—	A

1.3 Thermal and Package Characteristics

The following table lists the package characteristics of the MSCSM120HRM163AG device.

Table 1-9. Thermal and Package Characteristics

Symbol	Characteristic	Min.	Max.	Unit		
V _{ISOL}	RMS isolation voltage, any terminal to case t = 1 min, 50 Hz/60 Hz	4000	—	V		
T _J	Operating junction temperature range	−40	175	°C		
T _{JOP}	Recommended junction temperature under switching conditions	−40	T _{Jmax} −25			
T _{STG}	Storage temperature range	−40	125			
T _C	Operating case temperature	−40	125			
Torque	Mounting torque	To heatsink	M4	2	3	N.m
Wt	Package weight	—	110			g

1.4 Typical 1200V SiC MOSFET Performance Curve

The following figures show the SiC MOSFET performance curves of the Q1 and Q4 1200V phase leg SiC MOSFETs.

Figure 1-1. Maximum Thermal Impedance

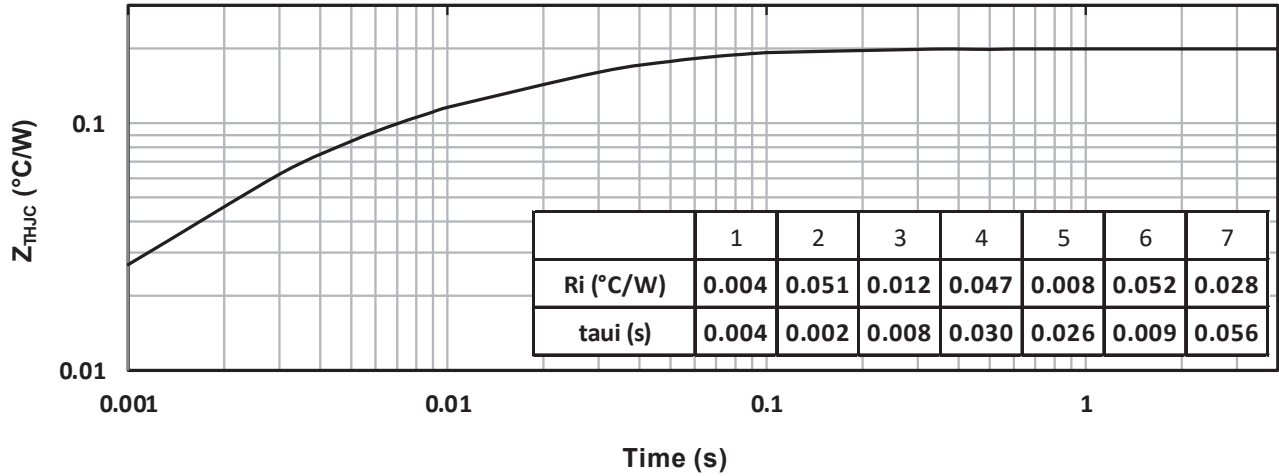

Figure 1-2. Output Characteristics, $T_J = 25\text{ }^\circ\text{C}$

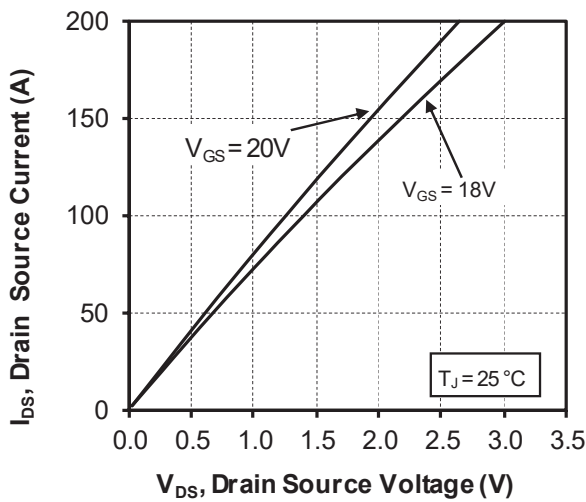

Figure 1-3. Output Characteristics, $T_J = 175\text{ }^\circ\text{C}$

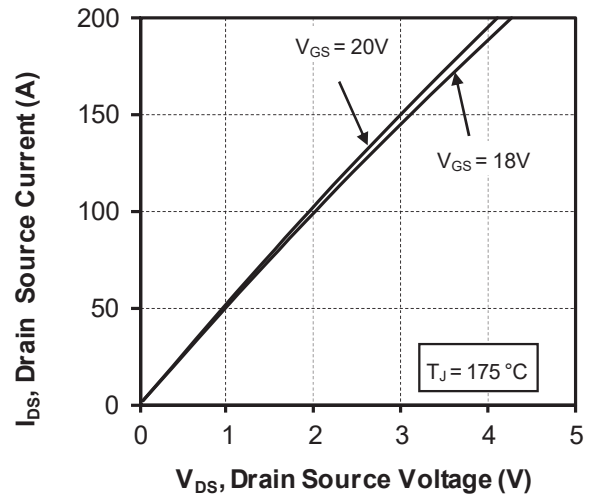

Figure 1-4. Normalized $R_{DS(on)}$ vs. Temperature

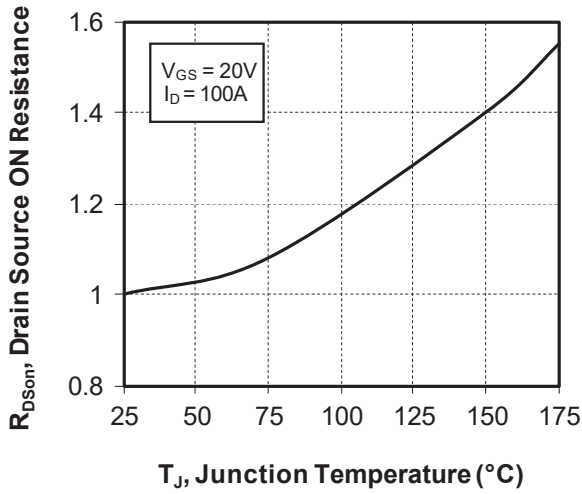

Figure 1-5. Transfer Characteristics

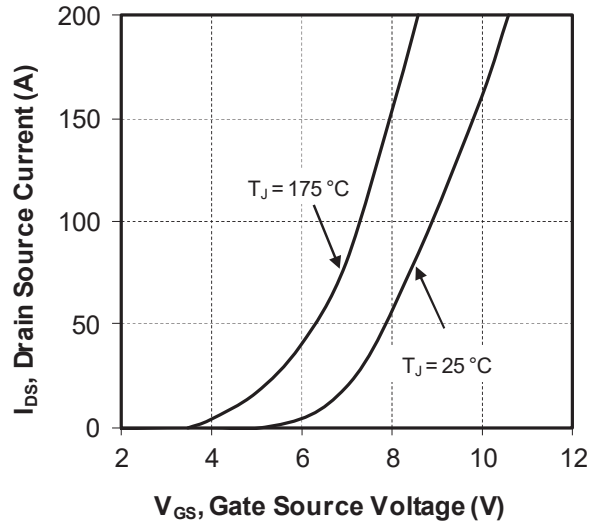

Figure 1-6. Switching Energy vs. R_g

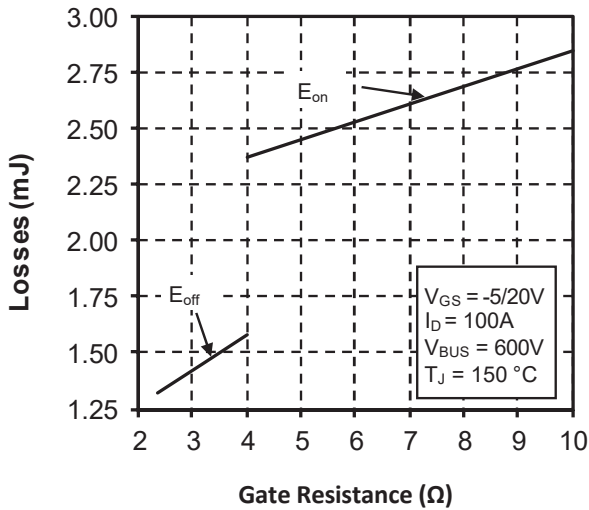
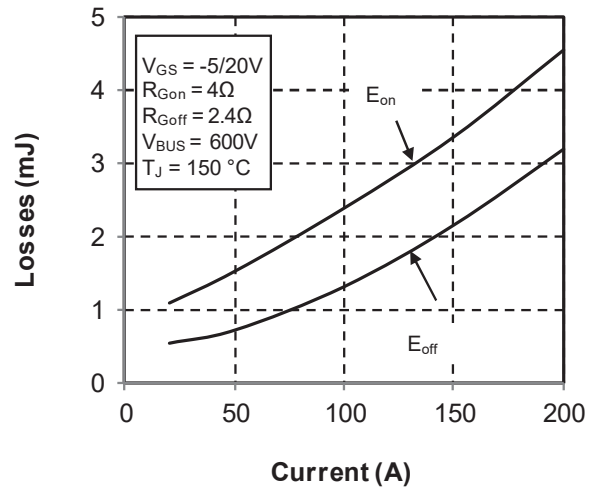

Figure 1-7. Switching Energy vs. Current



MSCSM120HRM163AG

Electrical Specifications

Figure 1-8. Capacitance vs. Drain Source Voltage

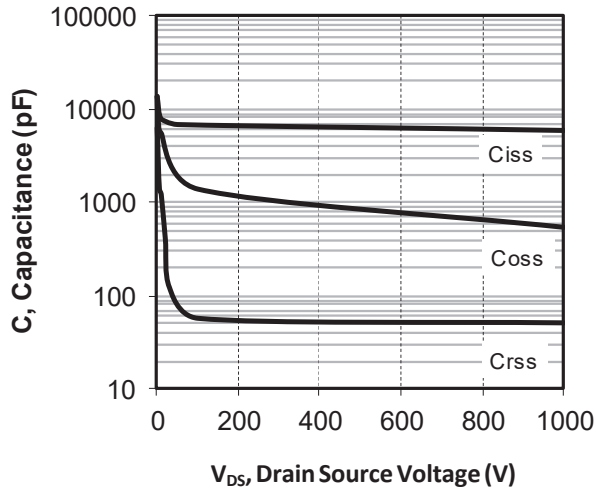

Figure 1-9. Gate Charge vs. Gate Source Voltage

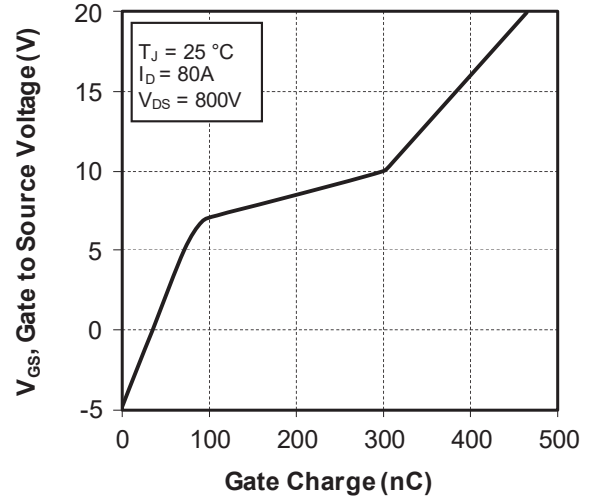

Figure 1-10. Body Diode Characteristics, $T_J = 25\text{ }^\circ\text{C}$

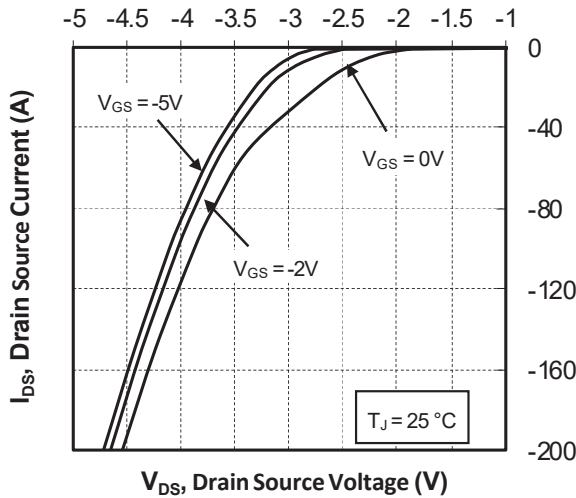

Figure 1-11. 3rd Quadrant Characteristics, $T_J = 25\text{ }^\circ\text{C}$

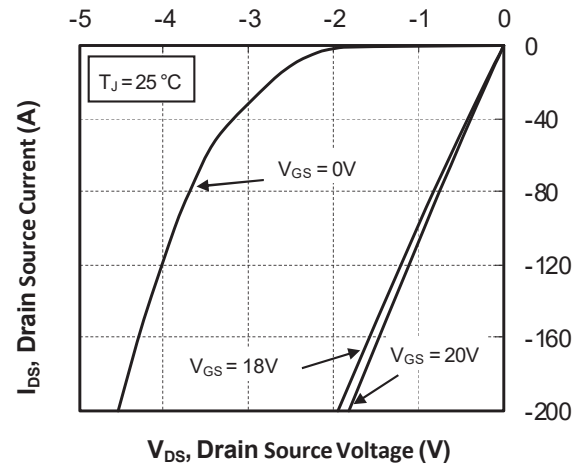

Figure 1-12. Body Diode Characteristics, $T_J = 175\text{ }^\circ\text{C}$

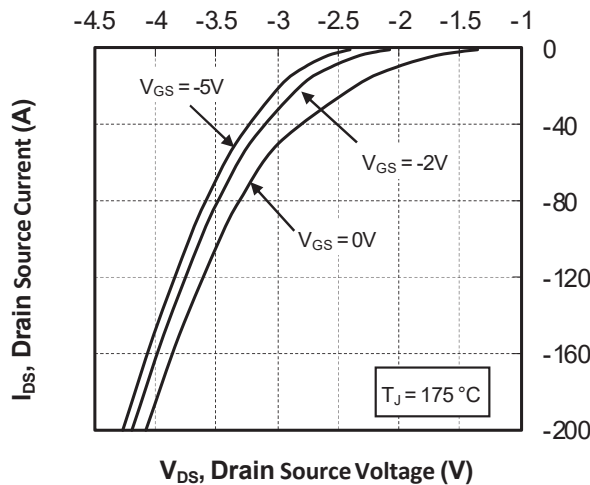

Figure 1-13. 3rd Quadrant Characteristics, $T_J = 175\text{ }^\circ\text{C}$

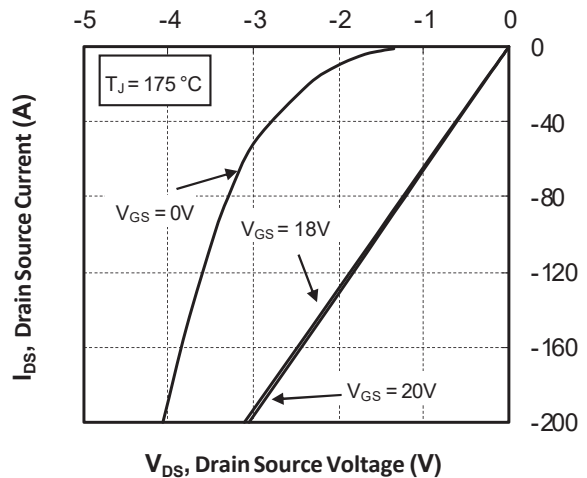
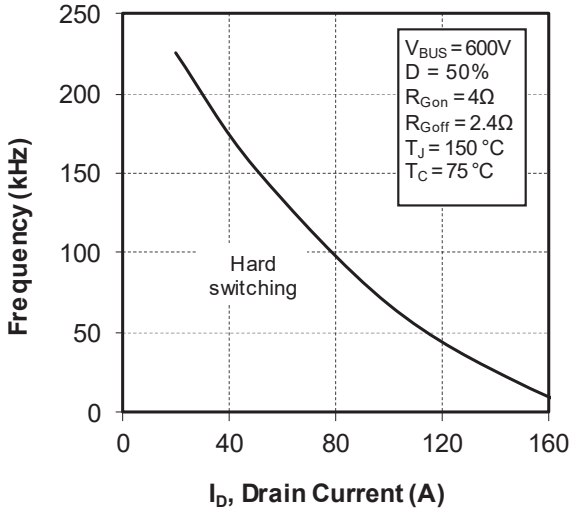

Figure 1-14. Operating Frequency vs. Drain Current



1.5 Typical 700V SiC MOSFET Performance Curve

The following figures show the SiC MOSFET performance curves of the Q2 and Q3 700V dual common source SiC MOSFETs.

Figure 1-15. Maximum Thermal Impedance

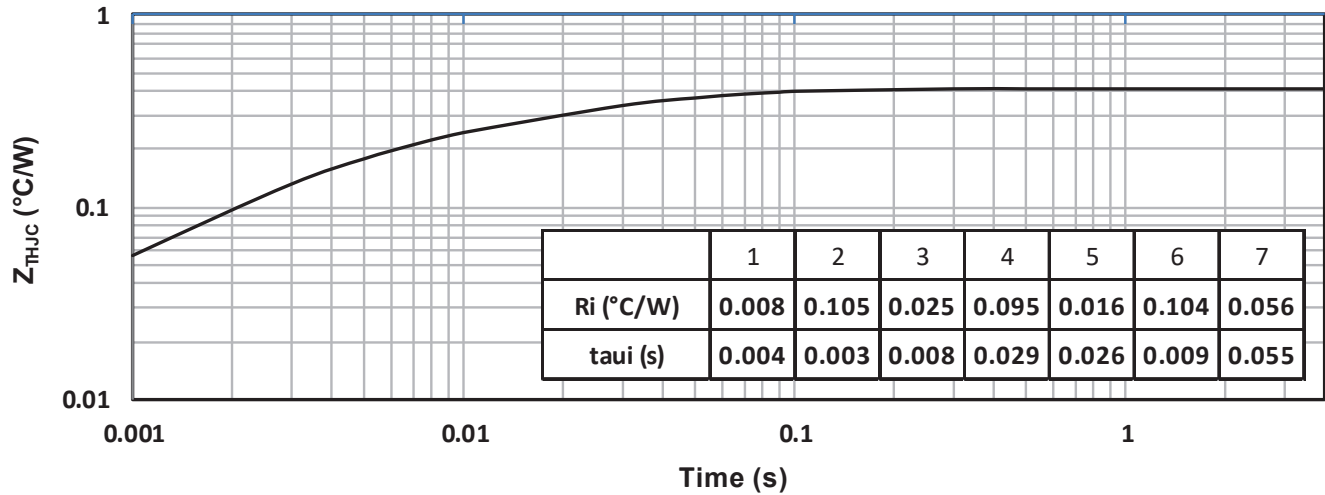

Figure 1-16. Output Characteristics, $T_J = 25\text{ }^\circ\text{C}$

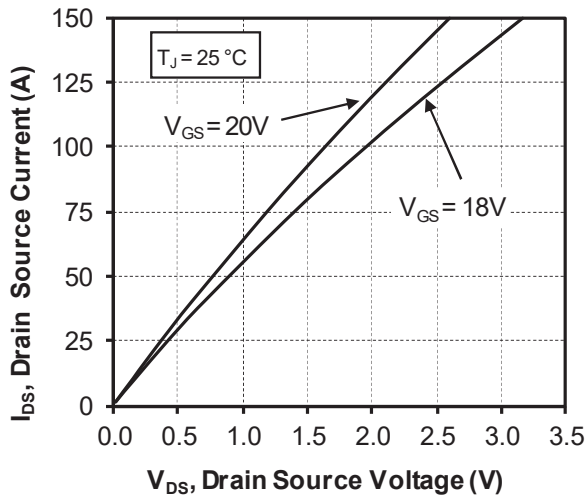

Figure 1-17. Output Characteristics, $T_J = 175\text{ }^\circ\text{C}$

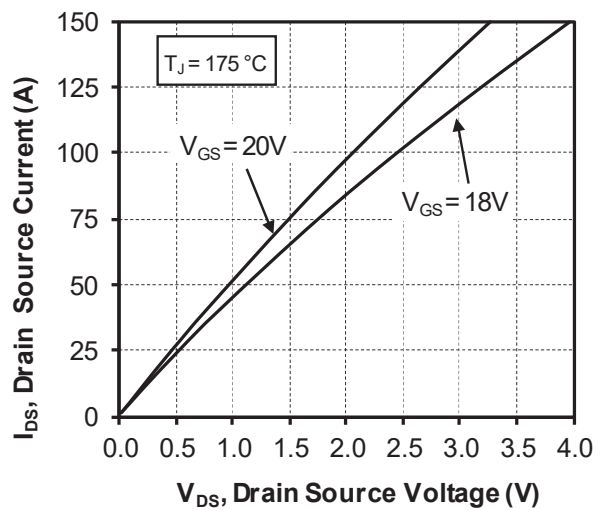

Figure 1-18. Normalized $R_{DS(on)}$ vs. Temperature

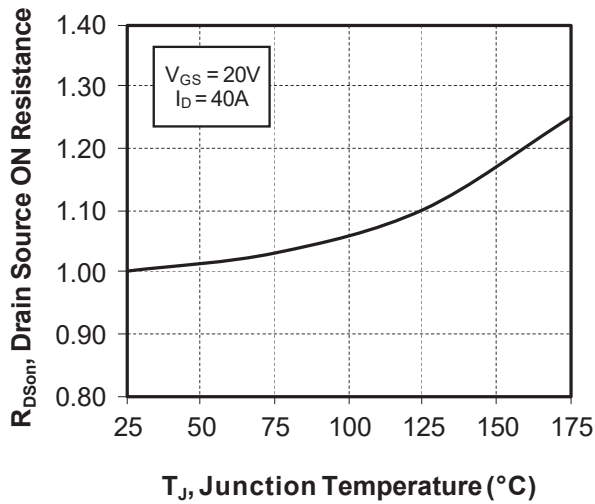

Figure 1-19. Transfer Characteristics

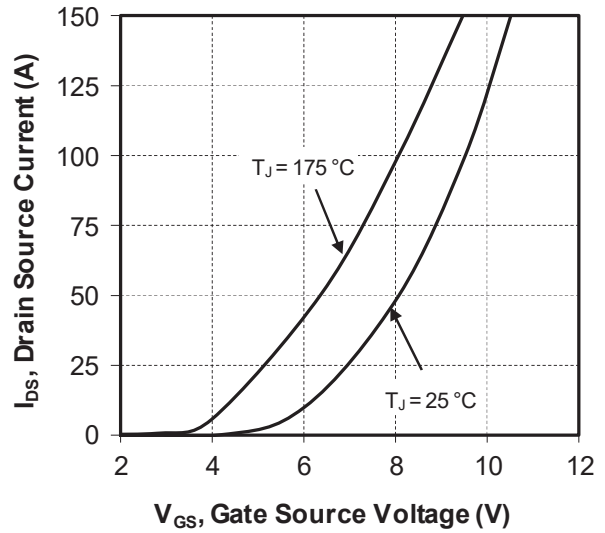

Figure 1-20. Capacitance vs. Drain Source Voltage

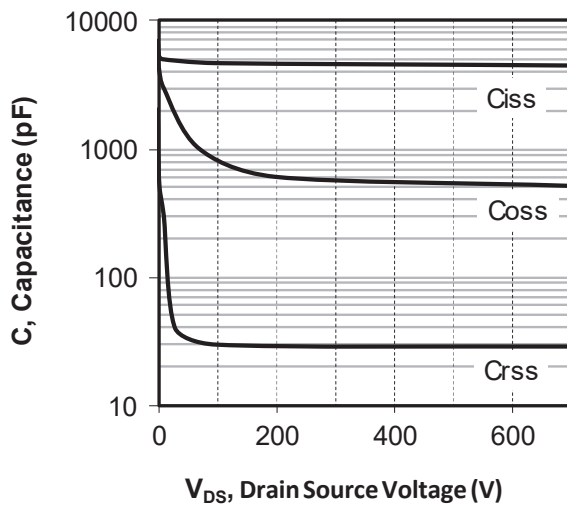

Figure 1-21. Gate Charge vs. Gate Source Voltage

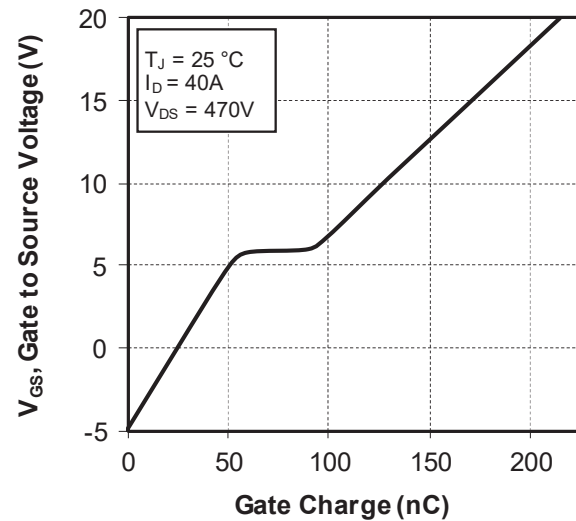

Figure 1-22. Body Diode Characteristics, $T_J = 25\text{ }^\circ\text{C}$

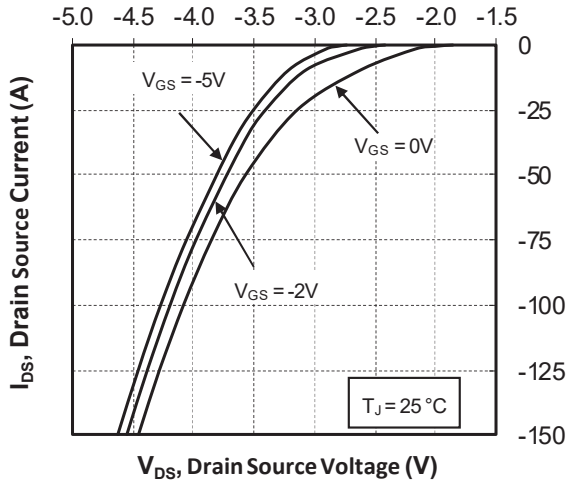

Figure 1-23. 3rd Quadrant Characteristics, $T_J = 25\text{ }^\circ\text{C}$

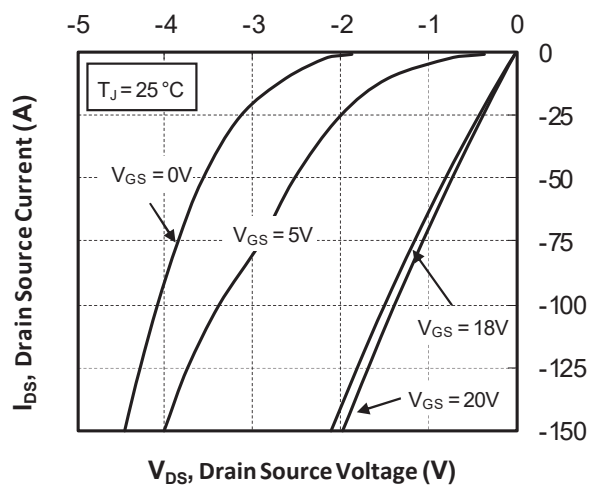

Figure 1-24. Body Diode Characteristics, $T_J = 175\text{ }^\circ\text{C}$

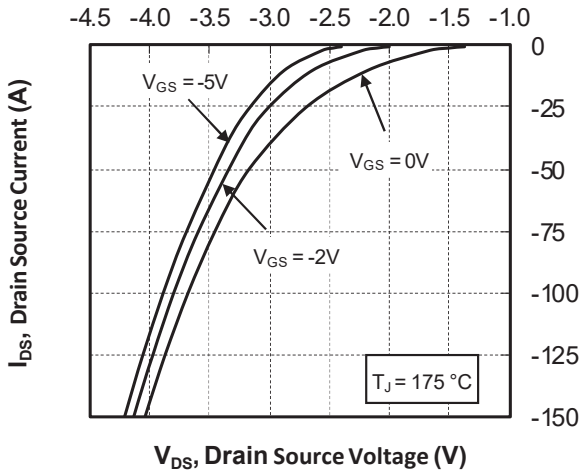

Figure 1-25. 3rd Quadrant Characteristics, $T_J = 175\text{ }^\circ\text{C}$

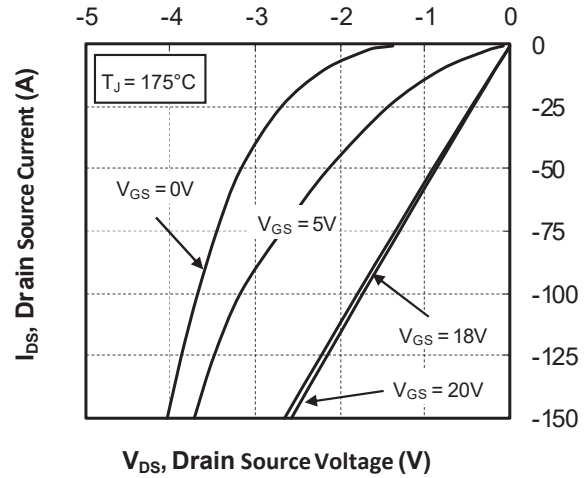

Figure 1-26. Switching Energy vs. Current

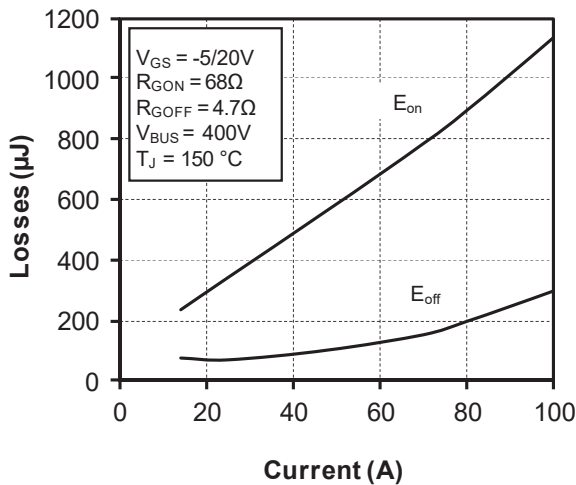

Figure 1-27. Turn On Energy vs. Rg

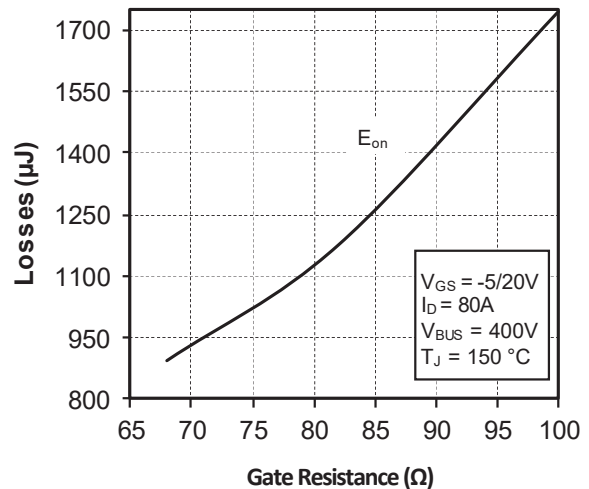

Figure 1-28. Turn Off Energy vs. Rg

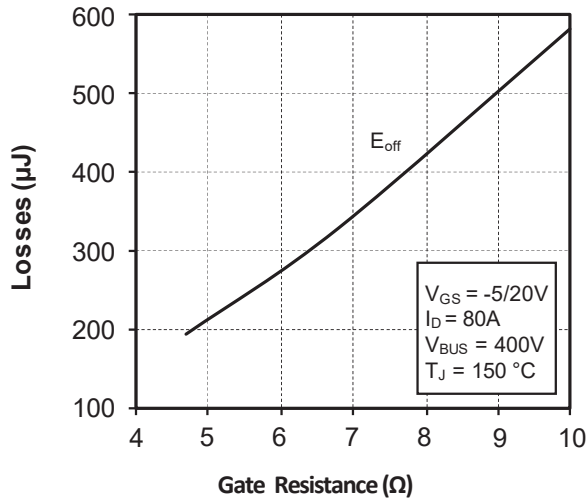
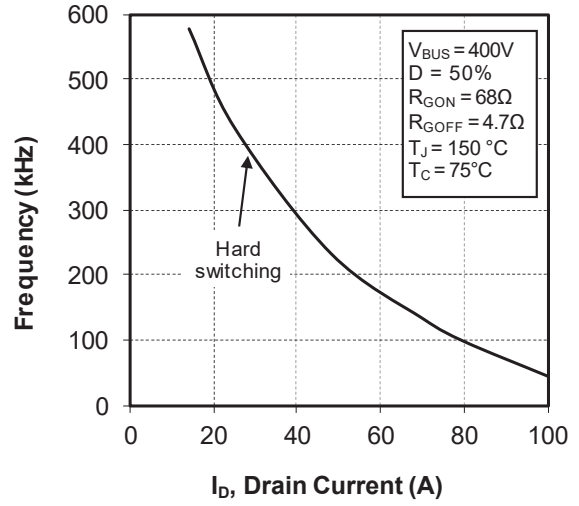

Figure 1-29. Operating Frequency vs. Drain Current



2. Package Specifications

The following section shows the package specification of the MSCSM120HRM163AG device.

2.1 Package Outline

The following figure shows the package outline drawing of the MSCSM120HRM163AG device. The dimensions in the following figure are in millimeters.

Figure 2-1. Package Outline Drawing

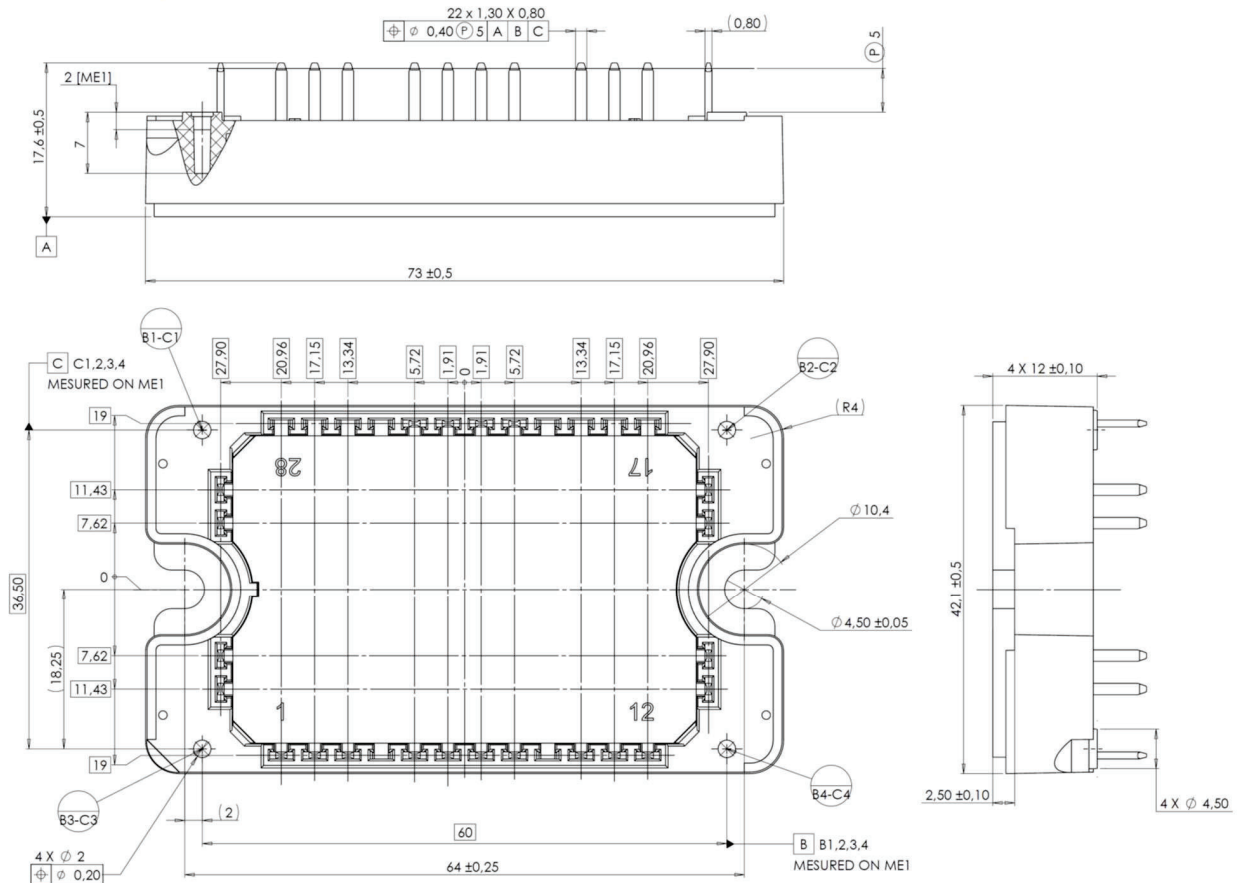

Note: For more information, see [AN3500—Mounting Instructions for SP1F and SP3F Power Modules](#).

3. Revision History

The revision history describes the changes that were implemented in the document. The changes are listed by revision, starting with the most current publication.

Revision	Date	Description
A	02/2023	Initial revision

Microchip Information

The Microchip Website

Microchip provides online support via our website at www.microchip.com/. This website is used to make files and information easily available to customers. Some of the content available includes:

- **Product Support** – Data sheets and errata, application notes and sample programs, design resources, user's guides and hardware support documents, latest software releases and archived software
- **General Technical Support** – Frequently Asked Questions (FAQs), technical support requests, online discussion groups, Microchip design partner program member listing
- **Business of Microchip** – Product selector and ordering guides, latest Microchip press releases, listing of seminars and events, listings of Microchip sales offices, distributors and factory representatives

Product Change Notification Service

Microchip's product change notification service helps keep customers current on Microchip products. Subscribers will receive email notification whenever there are changes, updates, revisions or errata related to a specified product family or development tool of interest.

To register, go to www.microchip.com/pcn and follow the registration instructions.

Customer Support

Users of Microchip products can receive assistance through several channels:

- Distributor or Representative
- Local Sales Office
- Embedded Solutions Engineer (ESE)
- Technical Support

Customers should contact their distributor, representative or ESE for support. Local sales offices are also available to help customers. A listing of sales offices and locations is included in this document.

Technical support is available through the website at: www.microchip.com/support

Microchip Devices Code Protection Feature

Note the following details of the code protection feature on Microchip products:

- Microchip products meet the specifications contained in their particular Microchip Data Sheet.
- Microchip believes that its family of products is secure when used in the intended manner, within operating specifications, and under normal conditions.
- Microchip values and aggressively protects its intellectual property rights. Attempts to breach the code protection features of Microchip product is strictly prohibited and may violate the Digital Millennium Copyright Act.
- Neither Microchip nor any other semiconductor manufacturer can guarantee the security of its code. Code protection does not mean that we are guaranteeing the product is "unbreakable". Code protection is constantly evolving. Microchip is committed to continuously improving the code protection features of our products.

Legal Notice

This publication and the information herein may be used only with Microchip products, including to design, test, and integrate Microchip products with your application. Use of this information in any other manner violates these terms. Information regarding device applications is provided only for your convenience and may be superseded

by updates. It is your responsibility to ensure that your application meets with your specifications. Contact your local Microchip sales office for additional support or, obtain additional support at www.microchip.com/en-us/support/design-help/client-support-services.

THIS INFORMATION IS PROVIDED BY MICROCHIP "AS IS". MICROCHIP MAKES NO REPRESENTATIONS OR WARRANTIES OF ANY KIND WHETHER EXPRESS OR IMPLIED, WRITTEN OR ORAL, STATUTORY OR OTHERWISE, RELATED TO THE INFORMATION INCLUDING BUT NOT LIMITED TO ANY IMPLIED WARRANTIES OF NON-INFRINGEMENT, MERCHANTABILITY, AND FITNESS FOR A PARTICULAR PURPOSE, OR WARRANTIES RELATED TO ITS CONDITION, QUALITY, OR PERFORMANCE.

IN NO EVENT WILL MICROCHIP BE LIABLE FOR ANY INDIRECT, SPECIAL, PUNITIVE, INCIDENTAL, OR CONSEQUENTIAL LOSS, DAMAGE, COST, OR EXPENSE OF ANY KIND WHATSOEVER RELATED TO THE INFORMATION OR ITS USE, HOWEVER CAUSED, EVEN IF MICROCHIP HAS BEEN ADVISED OF THE POSSIBILITY OR THE DAMAGES ARE FORESEEABLE. TO THE FULLEST EXTENT ALLOWED BY LAW, MICROCHIP'S TOTAL LIABILITY ON ALL CLAIMS IN ANY WAY RELATED TO THE INFORMATION OR ITS USE WILL NOT EXCEED THE AMOUNT OF FEES, IF ANY, THAT YOU HAVE PAID DIRECTLY TO MICROCHIP FOR THE INFORMATION.

Use of Microchip devices in life support and/or safety applications is entirely at the buyer's risk, and the buyer agrees to defend, indemnify and hold harmless Microchip from any and all damages, claims, suits, or expenses resulting from such use. No licenses are conveyed, implicitly or otherwise, under any Microchip intellectual property rights unless otherwise stated.

Trademarks

The Microchip name and logo, the Microchip logo, Adaptec, AVR, AVR logo, AVR Freaks, BesTime, BitCloud, CryptoMemory, CryptoRF, dsPIC, flexPWR, HELDO, IGLOO, JukeBlox, KeeLoq, Kleer, LANCheck, LinkMD, maXStylus, maXTouch, MediaLB, megaAVR, Microsemi, Microsemi logo, MOST, MOST logo, MPLAB, OptoLyzer, PIC, picoPower, PICSTART, PIC32 logo, PolarFire, Prochip Designer, QTouch, SAM-BA, SenGenuity, SpyNIC, SST, SST Logo, SuperFlash, Symmetricom, SyncServer, Tachyon, TimeSource, tinyAVR, UNI/O, Vectron, and XMEGA are registered trademarks of Microchip Technology Incorporated in the U.S.A. and other countries.

AgileSwitch, APT, ClockWorks, The Embedded Control Solutions Company, EtherSynch, Flashtec, Hyper Speed Control, HyperLight Load, Libero, motorBench, mTouch, Powermite 3, Precision Edge, ProASIC, ProASIC Plus, ProASIC Plus logo, Quiet-Wire, SmartFusion, SyncWorld, Temux, TimeCesium, TimeHub, TimePictra, TimeProvider, TrueTime, and ZL are registered trademarks of Microchip Technology Incorporated in the U.S.A.

Adjacent Key Suppression, AKS, Analog-for-the-Digital Age, Any Capacitor, AnyIn, AnyOut, Augmented Switching, BlueSky, BodyCom, Clockstudio, CodeGuard, CryptoAuthentication, CryptoAutomotive, CryptoCompanion, CryptoController, dsPICDEM, dsPICDEM.net, Dynamic Average Matching, DAM, ECAN, Espresso T1S, EtherGREEN, GridTime, IdealBridge, In-Circuit Serial Programming, ICSP, INICnet, Intelligent Paralleling, IntellIMOS, Inter-Chip Connectivity, JitterBlocker, Knob-on-Display, KoD, maxCrypto, maxView, memBrain, Mindi, MiWi, MPASM, MPF, MPLAB Certified logo, MPLIB, MPLINK, MultiTRAK, NetDetach, Omniscient Code Generation, PICDEM, PICDEM.net, PICkit, PICtail, PowerSmart, PureSilicon, QMatrix, REAL ICE, Ripple Blocker, RTAX, RTG4, SAM-ICE, Serial Quad I/O, simpleMAP, SimpliPHY, SmartBuffer, SmartHLS, SMART-I.S., storClad, SQL, SuperSwitcher, SuperSwitcher II, Switchtec, SynchroPHY, Total Endurance, Trusted Time, TSHARC, USBCheck, VariSense, VectorBlox, VeriPHY, ViewSpan, WiperLock, XpressConnect, and ZENA are trademarks of Microchip Technology Incorporated in the U.S.A. and other countries.

SQTP is a service mark of Microchip Technology Incorporated in the U.S.A.

The Adaptec logo, Frequency on Demand, Silicon Storage Technology, and Symmcom are registered trademarks of Microchip Technology Inc. in other countries.

GestIC is a registered trademark of Microchip Technology Germany II GmbH & Co. KG, a subsidiary of Microchip Technology Inc., in other countries.

All other trademarks mentioned herein are property of their respective companies.

© 2023, Microchip Technology Incorporated and its subsidiaries. All Rights Reserved.

ISBN: 978-1-6683-2059-4

Quality Management System

For information regarding Microchip's Quality Management Systems, please visit www.microchip.com/quality.

Worldwide Sales and Service

AMERICAS	ASIA/PACIFIC	ASIA/PACIFIC	EUROPE
<p>Corporate Office 2355 West Chandler Blvd. Chandler, AZ 85224-6199 Tel: 480-792-7200 Tel: 480-792-7277 Technical Support: www.microchip.com/support Web Address: www.microchip.com</p> <p>Atlanta Duluth, GA Tel: 678-957-9614 Fax: 678-957-1455</p> <p>Austin, TX Tel: 512-257-3370</p> <p>Boston Westborough, MA Tel: 774-760-0087 Fax: 774-760-0088</p> <p>Chicago Itasca, IL Tel: 630-285-0071 Fax: 630-285-0075</p> <p>Dallas Addison, TX Tel: 972-818-7423 Fax: 972-818-2924</p> <p>Detroit Novi, MI Tel: 248-848-4000</p> <p>Houston, TX Tel: 281-894-5983</p> <p>Indianapolis Noblesville, IN Tel: 317-773-8323 Fax: 317-773-5453 Tel: 317-536-2380</p> <p>Los Angeles Mission Viejo, CA Tel: 949-462-9523 Fax: 949-462-9608 Tel: 951-273-7800</p> <p>Raleigh, NC Tel: 919-844-7510</p> <p>New York, NY Tel: 631-435-6000</p> <p>San Jose, CA Tel: 408-735-9110 Tel: 408-436-4270</p> <p>Canada - Toronto Tel: 905-695-1980 Fax: 905-695-2078</p>	<p>Australia - Sydney Tel: 61-2-9868-6733</p> <p>China - Beijing Tel: 86-10-8569-7000</p> <p>China - Chengdu Tel: 86-28-8665-5511</p> <p>China - Chongqing Tel: 86-23-8980-9588</p> <p>China - Dongguan Tel: 86-769-8702-9880</p> <p>China - Guangzhou Tel: 86-20-8755-8029</p> <p>China - Hangzhou Tel: 86-571-8792-8115</p> <p>China - Hong Kong SAR Tel: 852-2943-5100</p> <p>China - Nanjing Tel: 86-25-8473-2460</p> <p>China - Qingdao Tel: 86-532-8502-7355</p> <p>China - Shanghai Tel: 86-21-3326-8000</p> <p>China - Shenyang Tel: 86-24-2334-2829</p> <p>China - Shenzhen Tel: 86-755-8864-2200</p> <p>China - Suzhou Tel: 86-186-6233-1526</p> <p>China - Wuhan Tel: 86-27-5980-5300</p> <p>China - Xian Tel: 86-29-8833-7252</p> <p>China - Xiamen Tel: 86-592-2388138</p> <p>China - Zhuhai Tel: 86-756-3210040</p>	<p>India - Bangalore Tel: 91-80-3090-4444</p> <p>India - New Delhi Tel: 91-11-4160-8631</p> <p>India - Pune Tel: 91-20-4121-0141</p> <p>Japan - Osaka Tel: 81-6-6152-7160</p> <p>Japan - Tokyo Tel: 81-3-6880-3770</p> <p>Korea - Daegu Tel: 82-53-744-4301</p> <p>Korea - Seoul Tel: 82-2-554-7200</p> <p>Malaysia - Kuala Lumpur Tel: 60-3-7651-7906</p> <p>Malaysia - Penang Tel: 60-4-227-8870</p> <p>Philippines - Manila Tel: 63-2-634-9065</p> <p>Singapore Tel: 65-6334-8870</p> <p>Taiwan - Hsin Chu Tel: 886-3-577-8366</p> <p>Taiwan - Kaohsiung Tel: 886-7-213-7830</p> <p>Taiwan - Taipei Tel: 886-2-2508-8600</p> <p>Thailand - Bangkok Tel: 66-2-694-1351</p> <p>Vietnam - Ho Chi Minh Tel: 84-28-5448-2100</p>	<p>Austria - Wels Tel: 43-7242-2244-39 Fax: 43-7242-2244-393</p> <p>Denmark - Copenhagen Tel: 45-4485-5910 Fax: 45-4485-2829</p> <p>Finland - Espoo Tel: 358-9-4520-820</p> <p>France - Paris Tel: 33-1-69-53-63-20 Fax: 33-1-69-30-90-79</p> <p>Germany - Garching Tel: 49-8931-9700</p> <p>Germany - Haan Tel: 49-2129-3766400</p> <p>Germany - Heilbronn Tel: 49-7131-72400</p> <p>Germany - Karlsruhe Tel: 49-721-625370</p> <p>Germany - Munich Tel: 49-89-627-144-0 Fax: 49-89-627-144-44</p> <p>Germany - Rosenheim Tel: 49-8031-354-560</p> <p>Israel - Ra'anana Tel: 972-9-744-7705</p> <p>Italy - Milan Tel: 39-0331-742611 Fax: 39-0331-466781</p> <p>Italy - Padova Tel: 39-049-7625286</p> <p>Netherlands - Druenen Tel: 31-416-690399 Fax: 31-416-690340</p> <p>Norway - Trondheim Tel: 47-72884388</p> <p>Poland - Warsaw Tel: 48-22-3325737</p> <p>Romania - Bucharest Tel: 40-21-407-87-50</p> <p>Spain - Madrid Tel: 34-91-708-08-90 Fax: 34-91-708-08-91</p> <p>Sweden - Gothenberg Tel: 46-31-704-60-40</p> <p>Sweden - Stockholm Tel: 46-8-5090-4654</p> <p>UK - Wokingham Tel: 44-118-921-5800 Fax: 44-118-921-5820</p>