

SIEMENS

RED **MSD2010TXV/TXVB**
 YELLOW **MSD2011TXV/TXVB**
 HIGH EFF. RED **MSD2012TXV/TXVB**
 HIGH EFF. GREEN **MSD2013TXV/TXVB**

T-41-

Intelligent

.150" 4-Character 5x7 Dot Matrix Serial Input Alphanumeric Military Display

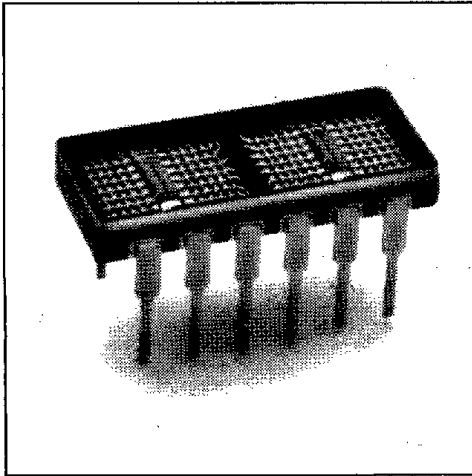

FEATURES

- Four .150" Dot Matrix Characters
- Four Colors: Red, Yellow, High Efficiency Red, High Efficiency Green
- Wide Viewing Angle
- Built-in CMOS Shift Registers with Constant Current LED Row Drivers
- Shift Registers Allow Custom Fonts
- Easily Cascaded for Multiple Displays
- TTL Compatible
- End Stackable
- Military Operating Temperature Range: -55° to +100°C
- Categorized for Luminous Intensity
- Ceramic Package, Hermetically Sealed Flat Glass Window
- TXVB Process Conforms to MIL-D-87157 Quality Level A Test and Tables I, II, IIIa and IVa
- TXV Process Conforms to a Modified MIL-D-87157 Quality Level A Test and Table I

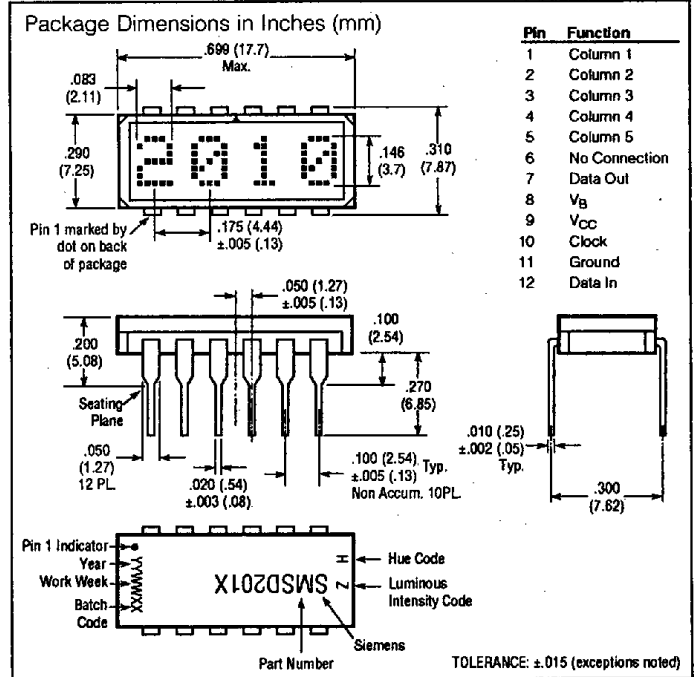

DESCRIPTION

The MSD2010 through MSD2013TXV/TXVB are four digit 5x7 dot matrix serial input alphanumeric displays. The displays are available in red, yellow, high efficiency red, or high efficiency green. The package is a standard twelve-pin hermetic DIP package with glass lens. The display can be stacked horizontally or vertically to form messages of any length. The MSD201X has two fourteen-bit CMOS shift registers with built-in row drivers. These shift registers drive twenty-eight rows and enable the design of customized fonts. Cascading multiple displays is possible because of the Data In and Data Out pins. Data In and Out are easily input with the clock signal and displayed in parallel on the row drivers. Data Out represents the output of the 7th bit of digit number four shift register. The shift register is level triggered. The like columns of each character in a display cluster are tied to a single pin. (See Block Diagram). High true data in the shift register enables the output current mirror driver stage associated with each row of LEDs in the 5x7 diode array.

The TTL compatible V_B input may either be tied to V_{CC} for maximum display intensity or pulse width modulated to achieve intensity control and reduce power consumption.

—Continued

See Appnote 44 for application information, and Appnotes 18, 19, 22, and 23 for additional information.

DESCRIPTION (Continued)

In the normal mode of operation, input data for digit four, column one is loaded into the seven on-board shift register locations one through seven. Column one data for digits 3, 2, and 1 is shifted into the display shift register locations. Then column one input is enabled for an appropriate period of time, T. A similar process is repeated for columns 2, 3, 4, and 5. If the decode time and load data time into the shift register is t, then with five columns, each column of the display is operating at a duty factor of:

$$DF = \frac{T}{5(T+t)}$$

T+t, allotted to each display column, is generally chosen to provide the maximum duty factor consistent with the minimum refresh rate necessary to achieve a flicker free display. For most strobed display systems, each column of the display should be refreshed (turned on) at a minimum rate of 100 times per second.

With columns to be addressed, this refresh rate then gives a value for the time T+t of: $1/[5 \times (100)] = 2$ msec. If the device is operated at 5.0 MHz clock rate maximum, it is possible to maintain $t \ll T$. For short display strings, the duty factor will then approach 20%.

Maximum Ratings

Supply Voltage V_{CC} to GND	-0.5 V to +7.0 V
Inputs, Data Out and V_B	-0.5 V to $V_{CC} + 0.5$ V
Column Input Voltage, V_{COL}	-0.5 V to +6.0 V
Operating Temperature Range ^(1 2)	-55°C to +100°C
Storage Temperature Range	-65°C to +125°C
Maximum Solder Temperature, 0.063" (1.59 mm) below Seating Plane, $t < 5$ sec	260°C
Maximum Power Dissipation at $T_{amb} = 25^\circ\text{C}$ ⁽²⁾	
Red	0.91 W
Yellow, HER, High Eff. Green	0.86 W

Notes:

- 1 Operation above +100°C ambient is possible provided the following condition are met. The junction should not exceed $T_J = 125^\circ\text{C}$ and the case temperature (as measured at pin 1 or the back of the display) should not exceed $T_C = 100^\circ\text{C}$
2. Maximum dissipation is derived from $V_{CC} = 5.25$ V, $V_B = 2.4$ V, $V_{COL} = 3.5$ V 20 LEDs on per character, 20% DF

FIGURE 1. TIMING CHARACTERISTICS

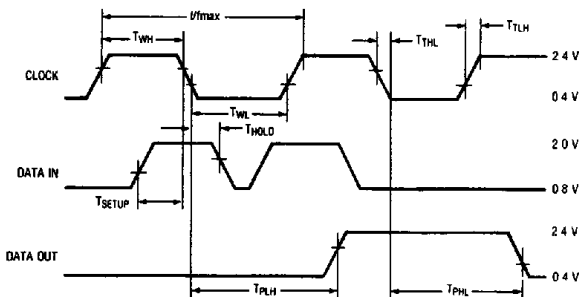
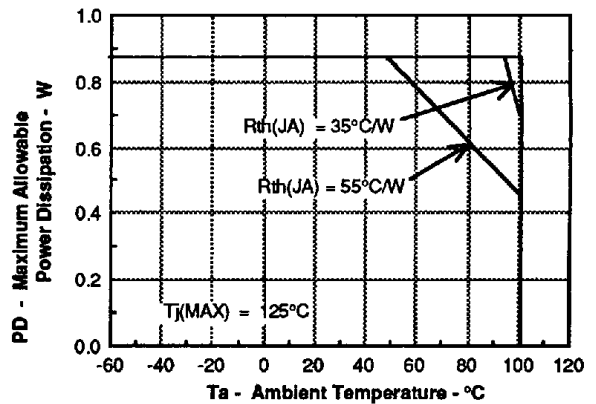

FIGURE 2. MAX. ALLOWABLE POWER DISSIPATION VS. TEMPERATURE



AC ELECTRICAL CHARACTERISTICS

($V_{CC} = 4.75$ to 5.25 V, $T_{amb} = -55^\circ\text{C}$ to $+100^\circ\text{C}$)

Symbol	Description	Min.	Typ ⁽¹⁾	Max ⁽²⁾	Units	Fig.
T_{SETUP}	Setup Time	50	10		ns	1
T_{HOLD}	Hold Time	25	20		ns	1
T_{WL}	Clock Width Low	75	45		ns	1
T_{WH}	Clock Width High	75	45		ns	1
$F_{(CLK)}$	Clock Frequency		6	5	MHz	1
T_{THL} , T_{TLH}	Clock Transition Time		75	200	ns	1
T_{PHL} , T_{PLH}	Propagation Delay Clock to Data Out		50	125	ns	1

Notes:

- 1 All typical values specified at $V_{CC} = 5.0$ V and $T_{amb} = 25^\circ\text{C}$ unless otherwise noted
- 2 V_B Pulse Width Modulation Frequency — 50 KHz (max)

CLEANING THE DISPLAYS

IMPORTANT — Do not use cleaning agents containing alcohol of any type with this display. The least offensive cleaning solution is hot D.I. water (60°C) for less than 15 minutes. Addition of mild saponifiers is acceptable. Do not use commercial dishwasher detergents.

For post solder cleaning use water or non-alcohol mixtures formulated for vapor cleaning processing or non-alcohol mixtures formulated for room temperature cleaning. Non-alcohol vapor cleaning processing for up to two minutes in vapors at boiling is permissible. For suggested solvents refer to Siemens Appnote 19.

RECOMMENDED OPERATING CONDITIONS

Parameter	Symbol	Min.	Nom.	Max.	Units
Supply Voltage	V _{CC}	4.75	5.0	5.25	V
Data Out Current, Low State	I _{OL}			1.6	mA
Data Out Current, High State	I _{OH}			-0.5	mA
Column Input Voltage, Column On ⁽¹⁾	V _{COL}	2.75		3.5	V
Setup Time	T _{SETUP}	70	45		ns
Hold Time	T _{HOLD}	30			ns
Width of Clock	T _{W(CLK)}	75			ns
Clock Frequency	T _{CLK}			5	MHz
Clock Transition Time	T _{THL}			200	ns
Free Air Operating Temperature Range	T _{amb}	-55		+100	°C

Note:

¹ See Figure 3 - Peak Column Current vs. Column Voltage

OPTICAL CHARACTERISTICS**Red MSD2010**

Description	Symbol	Min.	Typ. ⁽⁴⁾	Max.	Units	Test Conditions
Peak Luminous Intensity per LED ⁽¹⁻³⁾ (Character Average)	I _{VPEAK}	105	200		μcd	V _{CC} = 5.0 V, V _{COL} = 3.5 V T _J ⁽⁵⁾ = 25 °C, V _B = 2.4 V
Peak Wavelength	λ _{PEAK}		655		nm	
Dominant Wavelength ⁽²⁾	λ _D		639		nm	

Yellow MSD2011

Description	Symbol	Min.	Typ. ⁽⁴⁾	Max.	Units	Test Conditions
Peak Luminous Intensity per LED ⁽¹⁻³⁾ (Character Average)	I _{VPEAK}	400	750		μcd	V _{CC} = 5.0 V, V _{COL} = 3.5 V T _J ⁽⁵⁾ = 25 °C, V _B = 2.4 V
Peak Wavelength	λ _{PEAK}		583		nm	
Dominant Wavelength ⁽²⁾	λ _D		585		nm	

High Efficiency Red MSD2012

Description	Symbol	Min.	Typ. ⁽⁴⁾	Max.	Units	Test Conditions
Peak Luminous Intensity per LED ⁽¹⁻³⁾ (Character Average)	I _{VPEAK}	400	1430		μcd	V _{CC} = 5.0 V, V _{COL} = 3.5 V T _J ⁽⁵⁾ = 25 °C, V _B = 2.4 V
Peak Wavelength	λ _{PEAK}		635		nm	
Dominant Wavelength ⁽²⁾	λ _D		626		nm	

High Efficiency Green MSD2013

Description	Symbol	Min.	Typ. ⁽⁴⁾	Max.	Units	Test Conditions
Peak Luminous Intensity per LED ⁽¹⁻³⁾ (Character Average)	I _{VPEAK}	850	1550		μcd	V _{CC} = 5.0 V, V _{COL} = 3.5 V T _J ⁽⁵⁾ = 25 °C, V _B = 2.4 V
Peak Wavelength	λ _{PEAK}		568		nm	
Dominant Wavelength ⁽²⁾	λ _D		574		nm	

Notes:

- The displays are categorized for luminous intensity with the intensity category designated by a letter code on the bottom of the package
- Dominant wavelength λ_D is derived from the CIE chromaticity diagram, and represents the single wavelength which defines the color of the device
- The luminous sterance of the LED may be calculated using the following relationships

$$L_v \text{ (cd/m}^2\text{)} = I_v \text{ (Candela)/A (Meter)}^2$$

$$L_v \text{ (Footlamberts)} = \pi I_v \text{ (Candela)/A (Foot)}^2$$

$$A = 5.3 \times 10^{-8} \text{ M}^2 = 5.8 \times 10^{-7} \text{ (Foot)}^2$$
- All typical values specified at V_{CC} = 5.0 V and T_{amb} = 25 °C unless otherwise noted
- The luminous intensity is measured at T_{amb} = T_J = 25 °C. No time is allowed for the device to warm up prior to measurement

ELECTRICAL CHARACTERISTICS (-55°C to +100°C) (unless otherwise specified)

Description	Symbol	Min.	Typ. ⁽¹⁾	Max.	Units	Test Conditions	
Supply Current (quiescent)	I_{CC}		2	5.0	mA	$V_B = 0.4$ V	$V_{CC} = 5.25$ V $V_{CLK} = V_{DATA} = 2.4$ V All SR Stages = Logical 1
			2.5	5.0	mA	$V_B = 2.4$ V	
Supply Current (operating)	I_{CC}		3	10.0	mA	$F_{CLK} = 5$ MHz	
Column Current at any Column Input ⁽²⁾	All			10	μ A	$V_B = 0.4$ V	$V_{CC} = 5.25$ V $V_{COL} = 3.5$ V All SR Stages = Logical 1
	Red		350	435	mA	$V_B = 2.4$ V	
	Yellow, HER, Green		335	410	mA		
V_B , Clock or Data Input Threshold Low	V_{IL}			0.8	V	$V_{CC} = 4.75$ V - 5.25 V	
V_B , Clock or Data Input Threshold High	V_{IH}	2.0			V		
Data Out Voltage	V_{OH}	2.4	3.6		V	$I_{OH} = -0.5$ mA	$V_{CC} = 5.25$ V $I_{COL} = 0$ mA
	V_{OL}		0.2	0.4	V	$I_{OL} = 1.6$ mA	
Input Current Logical 0 V_B only	I_{IL}	-30	-110	-300	μ A	$V_{CC} = 4.75$ V - 5.25 V, $V_{IL} = 0.8$ V	
Input Current Logical 0 Data, Clock	I_{IL}		-1	-10	μ A		
Input Current Logical 1 Data, Clock	I_{IH}			10	μ A	$V_{CC} = 4.75$ V - 5.25 V, $V_{IH} = 2.4$ V	
Input Current Logical 1 V_B	I_{IH}			200	μ A		
Power Dissipation per Package	P_D		0.44		W	$V_{CC} = 5.0$ V, $V_{COL} = 3.5$ V, 17.5% DF 15 LEDs on per character, $V_B = 2.4$ V	
Thermal Resistance IC Junction-to-Pin	$R_{\theta J-PIN}$		30		$^{\circ}$ C/W/Device		

Notes:

- All typical values specified at $V_{CC} = 5.0$ V and $T_{amb} = 25^{\circ}$ C unless otherwise noted
- See Figure 3 - Peak Column Current vs. Column Voltage

FIGURE 3. PEAK COLUMN CURRENT VS. COLUMN VOLTAGE

FIGURE 4. BLOCK DIAGRAM



CONTRAST ENHANCEMENT FILTERS FOR SUNLIGHT READABILITY

Display Color Part No.	Filter Color	Marks Polarized Corp.* Filter Series	Optical Characteristics of Filter	Circular Polarizer
Red, HER MSD2010, 2012	Red	MPC 20-15C	25% @ 635 nm	
Yellow MSD2011	Amber	MPC 30-25C	25% @ 583 nm	
Green MSD2013	Yellow/Green	MPC 50-22C	22% @ 568 nm	
Multiple Colors High Ambient Light	Neutral Gray	MPC 80-10C	10% Neutral	
Multiple Colors	Neutral Gray	MPC 80-37C	37% Neutral	

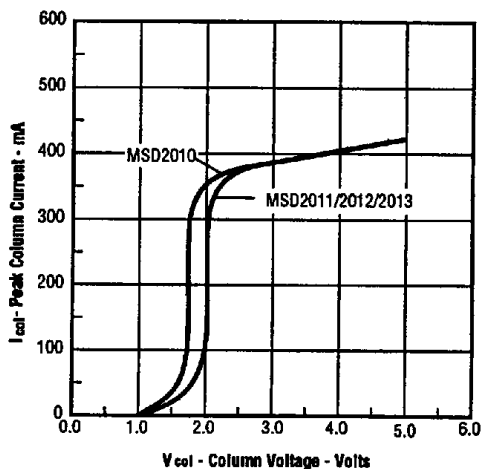
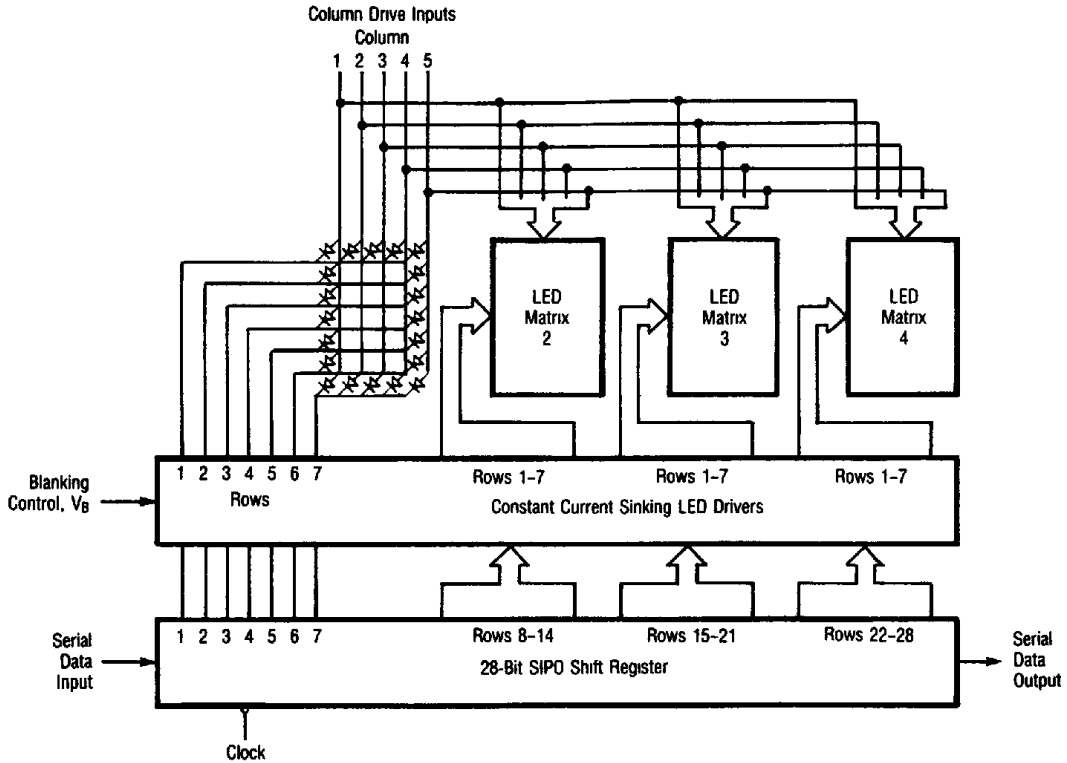
*Marks Polarized Corp
25-B Jefryn Blvd W
Deer Park, NY 11729
516-242-1300
FAX (516) 242-1347

Marks Polarized Corp manufactures to MIL-I-45208 inspection system

GENERAL QUALITY ASSURANCE LEVELS

The parts are tested in conformance with Quality Level A of MIL-D-87157 for hermetically sealed LED displays with 100% screening. The product is tested to Tables I, II, IIIa and IVa

Table I. Quality Level A of MIL-D-87157

Test Screen	Method	Conditions
1 Precap Visual	2072 MIL-STD-750	
2. High Temperature Storage	1032 MIL-STD-750	$T_{amb} = 125^{\circ}\text{C}$, Time = 24 hours
3. Temperature Cycling	1051 MIL-STD-750	Condition B, 10 Cycles, 15 min. Dwell $T_{amb} = -65^{\circ}\text{C}$ to $+125^{\circ}\text{C}$
4. Constant Acceleration	2006 MIL-STD-750	10,000 G's at Y_1 Orientation
5. Fine Leak	1071 MIL-STD-750	Condition H, Leak Rate $\leq 5 \times 10^{-7}$ cc/s
6. Gross Leak	1071 MIL-STD-750	Condition C
7 Interim Electrical/Optical Tests ⁽²⁾		I_{CC} (at $V_B = 0.4$ V and 2.4 V), I_{COL} (at $V_B = 0.4$ V and 2.4 V), I_{IH} (V_B , Clock and Data In), I_{IL} (V_B , Clock and Data In), I_{OH} , I_{OL} , Visual Function and I_V Peak. V_{IH} and V_{IL} inputs are guaranteed by the electronic shift register test. $T_{amb} = 25^{\circ}\text{C}$.
8 Burn-In ⁽¹⁾	1015 MIL-STD-883	Condition B at $V_{CC} = V_B = 5.25$ V, $V_{COL} = 3.5$ V, $T_{amb} = 100^{\circ}\text{C}$. LED On-Time Duty Factor = 5%, $t = 160$ hours
9 Final Electrical Test ⁽²⁾		Same as Step 7.
10 Delta Determinants		$\Delta I_{CC} = +/-1$ mA, $\Delta I_{IH} = +/-10$ mA (Clock and Data In), $\Delta I_{OH} = +/-10\%$ of initial value, $\Delta I_V = -20\%$
11 External Visual	2009 MIL-STD-883	

Table II. Group A Electrical Tests - MIL-D-87157

Subgroup/Test	Parameters	LTPD
Subgroup 1 DC Electrical Tests at 25°C	I_{CC} (at $V_B = 0.4$ V and 2.4 V), I_{COL} (at $V_B = 0.4$ V and 2.4 V), I_{IH} (V_B , Clock and Data In), I_{IL} (V_B , Clock and Data In), I_{OH} , I_{OL} , Visual Function and I_V Peak. V_{IH} and V_{IL} inputs are guaranteed by the electronic shift register test.	5
Subgroup 2 Selected DC Electrical Tests at High Temperatures ⁽²⁾	Same as Subgroup 1, except delete I_V and Visual Function, $T_{amb} = 100^{\circ}\text{C}$	7
Subgroup 3 Selected DC Electrical Tests at Low Temperatures ⁽²⁾	Same as Subgroup 1, except delete I_V and Visual Function, $T_{amb} = -55^{\circ}\text{C}$	7
Subgroup 4, 5 and 6 Not Tested		
Subgroup 7 Optical and Functional Tests at 25°C	Satisfied by Subgroup 1	5
Subgroup 8 External Visual	MIL-STD-883, Method 2009	7

Notes:

- MIL-STD-883 test method applies
- Limits and conditions are per the Electrical/Optical Characteristics. The I_{OH} and I_{OL} tests are the inverse of V_{OH} and V_{OL} specified in the Electrical Characteristics

Table IIIa. Group B, Classes A and B of MIL-D-87157

Subgroup/Test	MIL-STD-750 Method	Conditions	Sample Size
Subgroup 1 Resistance to Solvents	1022		4 Devices/0 Failures
Internal Visual and Mechanical	2075	Inspection may be performed through glass cover, includes front and back cavities	1 Device/0 Failures
Subgroup 2 ^(1 2) Solderability	2026	T _{amb} = 245°C for 5 seconds	LTPD = 15
Subgroup 3 Thermal Shock (Temp Cycle)	1051	Condition B1, 15 min. Dwell	LTPD = 15
Moisture Resistance ⁽³⁾ Visual Inspection Endpoints	1021	Within 24 hours after completion of moisture resistance test	
Hermetic Seal	1071		
Fine Leak	1071	Condition G or H	
Gross Leak	1071	Condition C	
Electrical/Optical Endpoints ⁽⁴⁾		I _{CC} (at V _B = 0.4 V and 2.4 V), I _{COL} (at V _B = 0.4 V and 2.4 V), I _{IH} (V _B , Clock and Data In), I _{IL} (V _B , Clock and Data In), I _{OH} , I _{OL} , Visual Function and I _V Peak. V _{IH} and V _{IL} inputs are guaranteed by the electronic shift register test. T _{amb} = 25°C.	
Subgroup 4 Operating Life Test (340 Hours)	1027	T _{amb} = + 100°C at V _{CC} = V _B = 5.25 V, V _{COL} = 3.5 V, LED on time DF = 5%	LTPD = 10
Electrical/Optical Endpoints ⁽⁴⁾		Same as Subgroup 3	
Subgroup 5 Non-Operating (Storage) Life Test (340 hours)	1032	T _{amb} = + 125°C	LTPD = 10
Electrical/Optical Endpoints ⁽⁴⁾		Same as Subgroup 3	

Notes:

- 1 Whenever electrical/optical tests are not required as endpoints, electrical rejects may be used
- 2 The LTPD applies to the number of leads inspected except in no case shall less than 3 displays be used to provide the number of leads required

- 3 Initial conditioning shall be a 15 degree inward bend and back to original position one cycle
- 4 Limits and conditions are per the Electrical/Optical Characteristics. The I_{OH} and I_{OL} tests are the inverse of V_{OH} and V_{OL} specified in the Electrical Characteristics

Intelligent
Display Devices

Table IVa. Group C, Classes A and B of MIL-D-87157

Subgroup/Test	MIL-STD-750 Method	Conditions	Sample Size
Subgroup 1 ⁽¹⁾ Physical Dimensions	2066		2 Devices/0 Failures
Subgroup 2 ^(1 2) Lead Integrity	2004	Condition B2	LTPD = 15
Hermetic Seal	1071		
Fine Leak	1071	Condition G or H	
Gross Leak	1071	Condition C	
Subgroup 3 Shock	2016	1500G's, Time = 0.5 ms, 5 Blows in Each Orientation X1, Y1, Y2	LTPD = 15
Vibration, Variable Frequency	2056		
Constant Acceleration	2006	10,000G's at Y1 Orientation	
External Visual ⁽³⁾	1010 or 1011		
Electrical/Optical Endpoints		I_{CC} (at $V_B = 0.4$ V and 2.4 V), I_{COL} (at $V_B = 0.4$ V and 2.4 V), I_{IH} (V_B , Clock and Data In), I_{OL} (V_B , Clock and Data In), I_{OH} , I_{OL} , Visual Function and I_y Peak. V_{IH} and V_{IL} inputs are guaranteed by the electronic shift register test $T_{amb} = 25^\circ\text{C}$.	
Subgroup 4 ^(5 6) Salt Atmosphere	1041		LTPD = 15
External Visual ⁽³⁾	1010 or 1011		
Subgroup 5 Bond Strength ⁽⁷⁾	2037	Condition A	LTPD = 20 (C = 0)
Subgroup 6 Operating Life Test ⁽⁸⁾	1026	$T_{amb} = +100^\circ\text{C}$ at $V_{CC} = V_B = 5.25$ V, $V_{COL} = 3.5$ V, LED on time DF = 5%	$\lambda = 10$
Electrical/Optical Endpoints ⁽⁴⁾		Same as Subgroup 3	

Notes:

- 1 The LTPD applies to the number of leads inspected except in no case shall less than three displays be used to provide the number of leads required
- 2 MIL-STD 883 test method applies
- 3 Visual requirements shall be as specified in MIL-STD-883, Methods 1010 or 1011.
- 4 Limits and conditions are per the electrical/optical characteristics
- 5 Whenever electrical/optical tests are not required as endpoints, electrical rejects may be used

- 6 Solderability samples shall not be used
- 7 Displays may be selected prior to seal
- 8 If any given inspection lot undergoing Group B inspection has been selected to satisfy Group C inspection requirements, the 340-hour life tests may be continued on test to 1000 hours in order to satisfy the Group C Life Test requirements. In such cases, either the 340-hour endpoint measurement shall be made a basis for Group B lot acceptance or the 1000-hour endpoint measurement shall be used as the basis for both Group B and Group C acceptance

THERMAL CONSIDERATIONS

The small alphanumeric displays are hybrid LED and CMOS assemblies that are designed for reliable operation in commercial, industrial, and military environments. Optimum reliability and optical performance will result when the junction temperature of the LEDs and CMOS ICs are kept as low as possible.

THERMAL MODELING

MSD201X displays consist of two driver ICs and four 5 x 7 LED matrixes. A thermal model of the display is shown in Figure 5. It illustrates that the junction temperature of the semiconductor = junction self heating + the case temperature rise + the ambient temperature. Equation 1 shows this relationship.

FIGURE 5. THERMAL MODEL

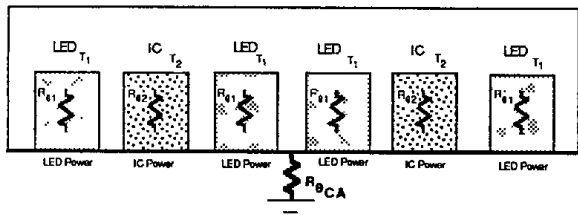

Equation 1.

$$T_{J(LED)} = P_{LED} Z_{\theta JC} + P_{CASE} (R_{\theta JC} + R_{\theta CA}) + T_A$$

$$T_{J(LED)} = [(I_{COL}/28) V_{F(LED)} Z_{\theta JC}] + [(n/35) I_{COL} DF (5 V_{COL} + V_{CC} I_{CC}) \cdot [R_{\theta JC} + R_{\theta CA}] + T_A$$

The junction rise within the LED is the product of the thermal impedance of an individual LED (37°C/W, DF = 20%, F = 200 Hz), times the forward voltage, $V_{F(LED)}$, and forward current, $I_{F(LED)}$, of 13 - 14.5 mA. This rise averages $T_{J(LED)} = 1^\circ C$. The table below shows the $V_{F(LED)}$ for the respective displays

Part Number	V_F		
	Min.	Typ.	Max.
MSD2010	1.6	1.7	2.0
MSD2011/2/3	1.9	2.2	3.0

The junction rise within the LED driver IC is the combination of the power dissipated by the IC quiescent current and the 28 row driver current sinks. The IC junction rise is given in Equation 2.

A thermal resistance of 28°C/W results in a typical junction rise of 6°C.

Equation 2.

$$T_{J(IC)} = P_{COL} (R_{\theta JC} + R_{\theta CA}) + T_A$$

$$T_{J(IC)} = [5 (V_{COL} - V_{F(LED)}) \cdot (I_{COL} / 2) \cdot (n/35) DF + V_{CC} \cdot I_{CC}] \cdot [R_{\theta JC} + R_{\theta CA}] + T_A$$

THERMAL MODELING (Cont.)

For ease of calculations the maximum allowable electrical operating condition is dependent upon the aggregate thermal resistance of the LED matrixes and the two driver ICs. All of the thermal management calculations are based upon the parallel combination of these two networks which is 15°C/W. Maximum allowable power dissipation is given in Equation 3.

Equation 3.

$$P_{\text{DISPLAY}} = \frac{T_{\text{J(MAX)}} - T_{\text{A}}}{R_{\theta\text{JC}} + R_{\theta\text{CA}}}$$

$$P_{\text{DISPLAY}} = 5 V_{\text{COL}} I_{\text{COL}} (n/35) \text{ DF} + V_{\text{CC}} I_{\text{CC}}$$

For further reference see Figures 2, 7, 8, 9, 10 and 11.

KEY TO EQUATION SYMBOLS

DF	Duty factor
I _{CC}	Quiescent IC current
I _{COL}	Column current
n	Number of LEDs on in a 5 × 7 array
P _{CASE}	Package power dissipation excluding LED under consideration
P _{COL}	Power dissipation of a column
P _{DISPLAY}	Power dissipation of the display
P _{LED}	Power dissipation of an LED
R _{θCA}	Thermal resistance case to ambient
R _{θJC}	Thermal resistance junction to case
T _A	Ambient temperature
T _{J(IC)}	Junction temperature of an IC
T _{J(LED)}	Junction temperature of a LED
T _{J(MAX)}	Maximum junction temperature
V _{CC}	IC voltage
V _{COL}	Column voltage
V _{F(LED)}	Forward voltage of LED
Z _{θJC}	Thermal impedance junction to case

OPTICAL CONSIDERATIONS

The light output of the LEDs is inversely related to the LED diode's junction temperature as shown in Figure 6. For optimum light output, keep the thermal resistance of the socket or PC board as low as possible.

FIGURE 6. NORMALIZED LUMINOUS INTENSITY VS. JUNCTION TEMPERATURE

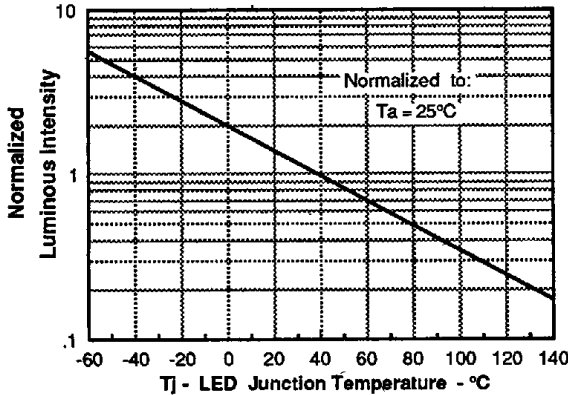

When mounted in a 10°C/W socket and operated at Absolute Maximum Electrical conditions, the MSD201X will show an LED junction rise of 17°C . If $T_A = 40^\circ\text{C}$, then the LED's T_J will be 57°C . Under these conditions Figure 7 shows that the I_V will be 75% of its 25°C value.

FIGURE 7. MAX. LED JUNCTION TEMPERATURE VS. SOCKET THERMAL RESISTANCE

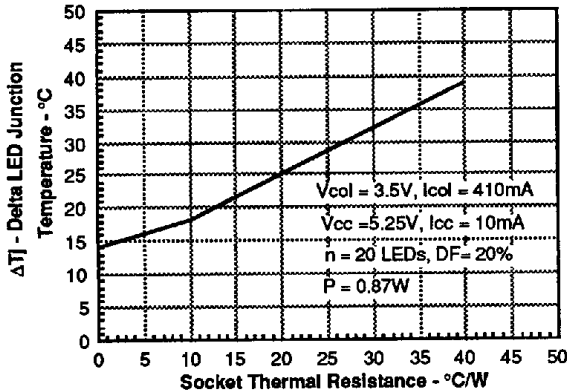

FIGURE 8. MAX. PACKAGE POWER DISSIPATION

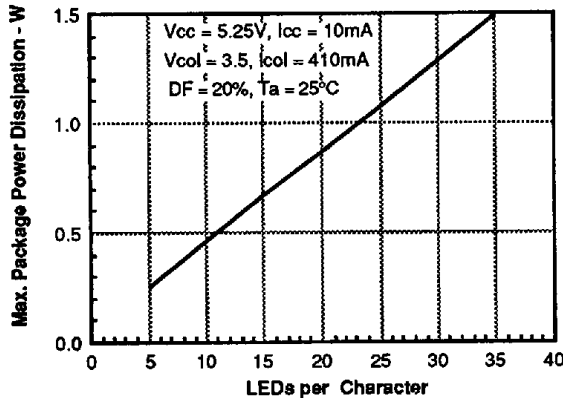

FIGURE 9. PACKAGE POWER DISSIPATION

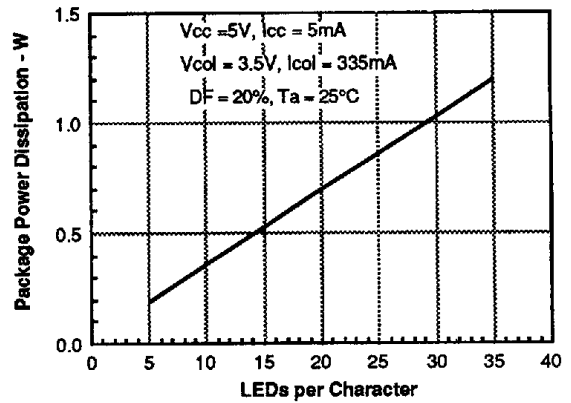

FIGURE 10. MAX. CHARACTER POWER DISSIPATION

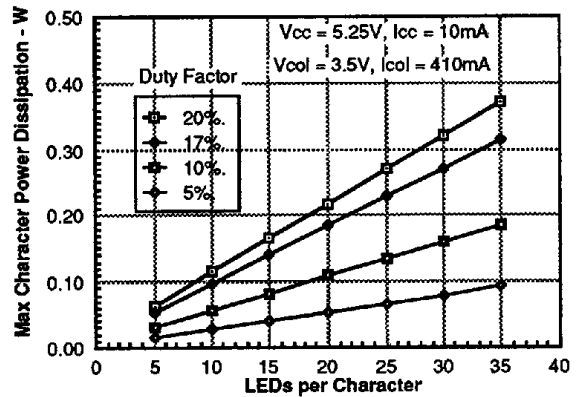

FIGURE 11. CHARACTER POWER DISSIPATION

