

CRYSTAL CONTROLLED OSCILLATORS

SURFACE MOUNT "J" LEADED HCMOS CLOCK OSCILLATOR

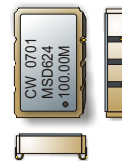

MSD624

ABSOLUTE MAXIMUM RATINGS

TABLE 1.0

PARAMETER	UNITS	MINIMUM	NOMINAL	MAXIMUM	UNITS	NOTE
Storage Temperature		-55	-	125	°C	
Supply Voltage	(Vcc)	-0.5	-	7	Vdc	

OPERATING SPECIFICATIONS

TABLE 2.0

PARAMETER		MINIMUM	NOMINAL	MAXIMUM	UNITS	NOTE
Frequency Range	(Fo)	1.8	-	156.25	MHz	
Total Frequency Tolerance		-50	-	50	ppm	1
Operating Temperature Range		-40	-	85	°C	
Supply Voltage	(Vcc)	4.50	5.00	5.50	Vdc	
Supply Current	(Icc)	-	-	50	mA	
Jitter (BW=10Hz to 20MHz)		-	-	5	ps rms	
Jitter (BW=12kHz to 20MHz)		-	-	1	ps rms	
SSB Phase Noise at 10Hz offset		-	-60	-	dBc/Hz	
SSB Phase Noise at 100Hz offset		-	-90	-	dBc/Hz	
SSB Phase Noise at 1KHz offset		-	-125	-	dBc/Hz	
SSB Phase Noise at 10KHz offset		-	-135	-	dBc/Hz	
SSB Phase Noise at 100KHz offset		-	-140	-	dBc/Hz	

INPUT CHARACTERISTICS

TABLE 3.0

PARAMETER		MINIMUM	NOMINAL	MAXIMUM	UNITS	NOTE
Tri-state Enable Voltage	(Vih)	≥70%Vcc	-	-	Vdc	2
Tri-state Disable Voltage	(Vil)	-	-	≤30%Vcc	Vdc	2

HCMOS OUTPUT
CHARACTERISTICS

TABLE 4.0

PARAMETER		MINIMUM	NOMINAL	MAXIMUM	UNITS	NOTE
LOAD		-	-	50	pF	
Voltage (High)	(Voh)	≥ 0.9(Vcc)	-	-	Vdc	
(Low)	(Vol)	-	-	≤ 0.1(Vcc)	Vdc	
Current (High)	(Ioh)	-16	-	-	mA	
(Low)	(Iol)	-	-	16	mA	
Duty Cycle at 50% of Vcc		45	50	55	%	
Rise / Fall Time 10% to 90%		-	1.5	3	nS	

PACKAGE CHARACTERISTICS

TABLE 5.0

Package	Hermetically sealed, ceramic package with gold plated J leads.
---------	--

Note:

- Inclusive of calibration, frequency vs. temperature stability, supply voltage change, load change, shock and vibration, 20 years aging.
- Oscillator output is enabled with no connection on pad 1

DESCRIPTION

The Connor-Winfield MSD624 is a hermetically sealed surface mount 5.0V Crystal Controlled Oscillator (XO) HCMOS/TTL Compatible. The MSD624 is designed for applications requiring low jitter and tight stability.

FEATURES

- 5.0V OPERATION
- LOW JITTER <1ps RMS
- FREQUENCY TOLERANCE: ±50ppm
- TEMPERATURE RANGE: -40 to 85°C
- TRI-STATE ENABLE/DISABLE FUNCTION
- TAPE AND REEL PACKAGING

ORDERING INFORMATION

MSD624 - 100.00 MHz

HCMOS
CLOCK
SERIES

CENTER
FREQUENCY

Specifications subject to change without notice.

CRYSTAL CONTROLLED OSCILLATORS

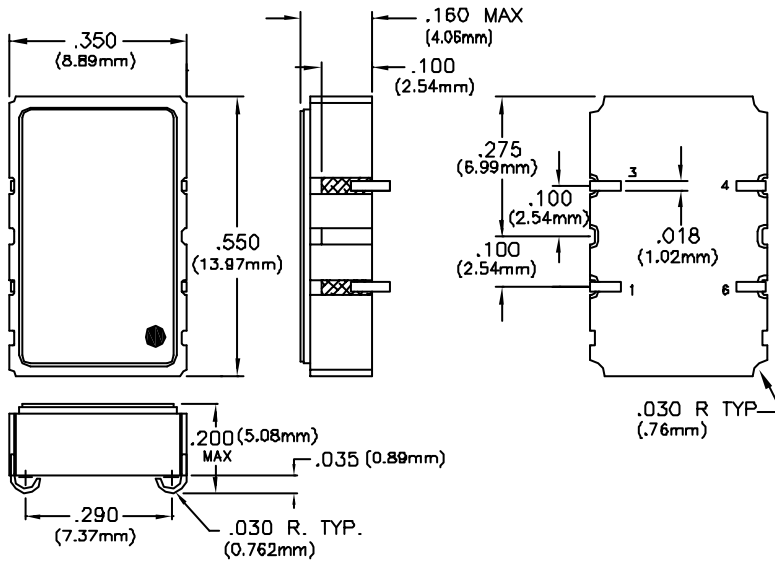

PAD	CONNECTION
1	E/D TRI-STATE
3	GROUND
4	OUTPUT
6	Vcc

OUTPUT WAVEFORM

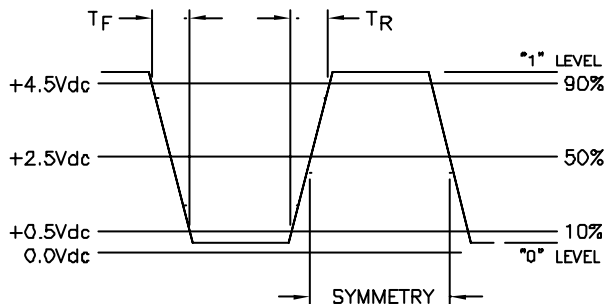

SUGGESTED PAD LAYOUT

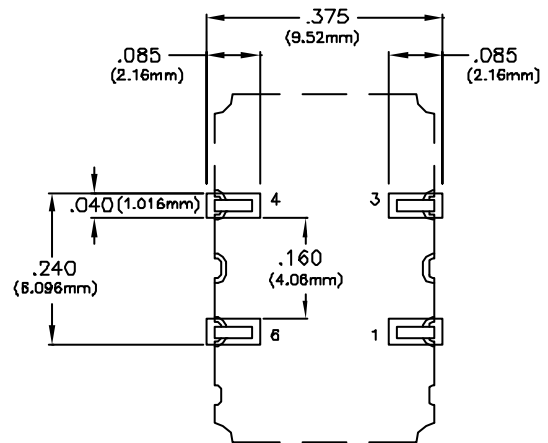

TEST CIRCUIT

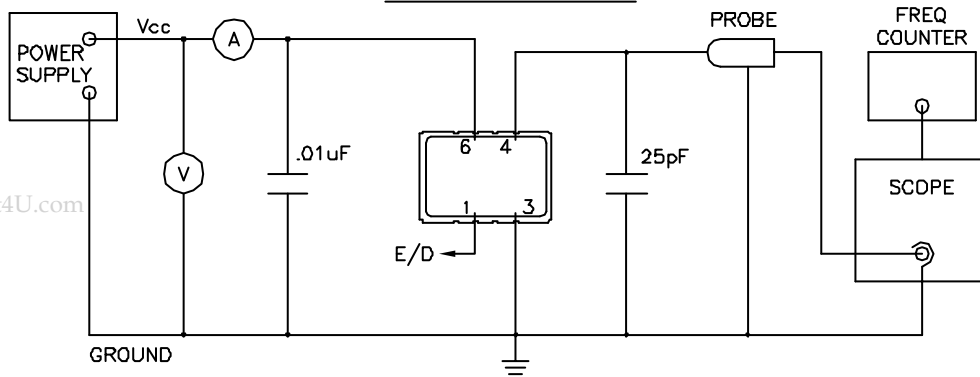

www.DataSheet4U.com

Specifications subject to change without notice.