

MSK**ULTRA HIGH VOLTAGE
OPERATIONAL AMPLIFIER****158/159****M. S. KENNEDY CORP.**

4707 Dey Road Liverpool, N.Y. 13088

(315) 701-6751

FEATURES:

- Monolithic MOS Technology
- Low Cost
- High Voltage Operation - 350V
- Low Quiescent Current - 2mA Max.
- High Output Current - 60mA Min.
- No Secondary Breakdown
- High Speed - 40V/ μ S Typ.

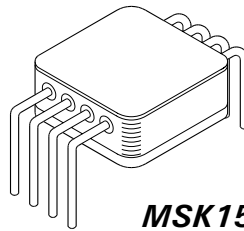
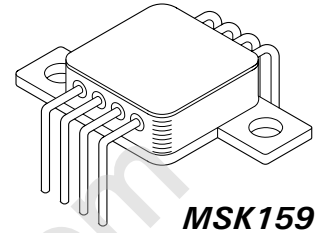
MIL-PRF-38534 QUALIFIED**MSK158****MSK159****DESCRIPTION:**

The MSK 158 is an ultra high voltage monolithic MOSFET operational amplifier ideally suited for electrostatic transducer and electrostatic deflection applications. With a total supply voltage rating of 350 volts and 60mA of available output current, the MSK 158 is also an excellent low cost choice for high voltage piezo drive circuits. The MOSFET output frees the MSK 158 from secondary breakdown limitations and power dissipation is kept to a minimum with a quiescent current rating of only 2mA. The MSK 158 is packaged in a hermetically sealed 8 pin power dip which has two external compensation pins. For applications requiring heat sinking, the MSK 159 is available with bolt down tabs and is otherwise identical to the MSK 158 (see mechanical specifications).

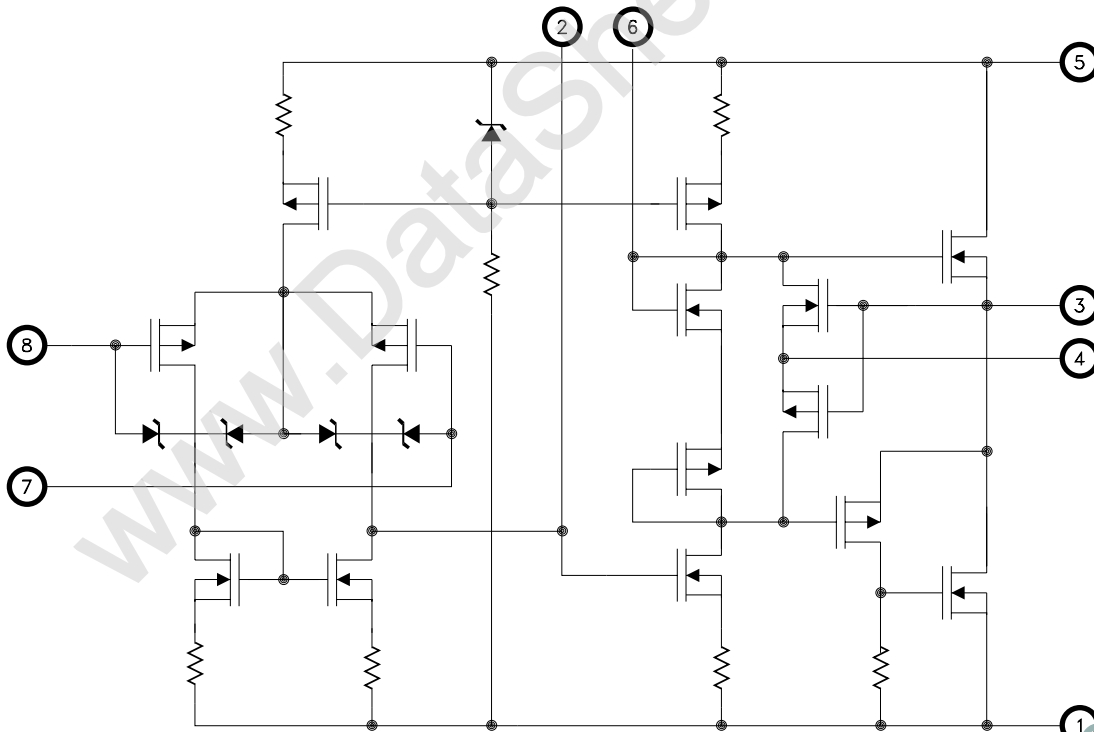
EQUIVALENT SCHEMATIC**TYPICAL APPLICATIONS**

- Piezo Electric Positioning
- Electrostatic Deflection
- Computer to Vacuum Tube Interface
- Ultra High Voltage Op-Amp Applications

PIN-OUT INFORMATION

- | | |
|-----------------|-----------------------|
| 1 -Vcc | 7 Inverting Input |
| 2 Comp 1 | 8 Non-Inverting Input |
| 3 Output Drive | 9 Comp 2 |
| 4 Current Sense | 10 +Vcc |

ABSOLUTE MAXIMUM RATINGS

V _{CC}	Total Supply Voltage	350V
± I _{OUT}	Output Current (within S.O.A.)	60mA
± I _{OUTP}	Output Current Peak	120mA
V _{IND}	Input Voltage (Differential)	± 16V
V _{IN}	Input Voltage (Common Mode)	± V _{CC}
T _J	Junction Temperature	150°C

T _{ST}	Storage Temperature	-65°C to + 150°C
T _{LD}	Lead Temperature	300°C
T _C	Case Operating Temperature (MSK 158B/E/159B/E)	-55°C to + 125°C
	(MSK158/159)	-40°C to + 85°C
R _{TH}	Thermal Resistance (DC) Junction to Case	10°C/W

ELECTRICAL SPECIFICATIONS

Parameter	Test Conditions	Group A Subgroup	MSK 158B/E/159B/E			MSK 158/159			Units
			Min.	Typ.	Max.	Min.	Typ.	Max.	
STATIC									
Supply Voltage Range ② ④ ⑨		-	± 50	± 150	± 175	± 50	± 150	± 175	V
Quiescent Current	V _{IN} = 0V	1	-	± 1.4	± 2.0	-	± 1.4	± 2.0	mA
		2	-	± 2.0	± 3.0	-	-	-	mA
		3	-	± 1.0	± 2.1	-	-	-	mA
INPUT									
Offset Voltage	V _{IN} = 0V	1	-	± 15	± 30	-	± 15	± 30	mV
Offset Voltage Drift ④	V _{IN} = 0V	2,3	-	± 40	± 65	-	-	-	μV/°C
Offset Voltage vs ± V _{CC} ④	V _{IN} = 0V	1	-	± 20	± 32	-	± 20	± 32	μV/V
Input Bias Current ④	V _{CM} = 0V	1	-	± 5	± 50	-	± 5	± 100	pA
		2,3	-	-	± 50	-	-	-	nA
Input Impedance ④	(DC)	-	-	10 ¹¹	-	-	10 ¹¹	-	Ω
Input Capacitance ④		-	-	5	-	-	5	-	pF
Common Mode Rejection ④	V _{CM} = ± 90VDC	-	84	94	-	84	94	-	dB
Noise	1Hz ≤ f ≤ 10Hz	-	-	50	-	-	50	-	μV _{RMS}
OUTPUT									
Output Voltage Swing	I _{OUT} = ± 40mA Peak	4	± 138	± 141	-	± 138	± 141	-	V
Output Current	V _{OUT} = MAX	4	± 60	± 120	-	± 60	± 120	-	mA
Power Bandwidth ④	C _C = 10pF V _{OUT} = 280V _{PP}	-	-	26	-	-	26	-	KHz
Resistance ④	No Load, R _{CL} = 0Ω	-	-	150	-	-	150	-	Ω
Settling Time to 0.1% ③ ④	C _C = 10pF 10V Step	-	-	12	-	-	12	-	μS
Capacitive Load ④	A _V = + 1V/V	-	10	-	-	10	-	-	nF
TRANSFER CHARACTERISTICS									
Slew Rate	C _C = Open	4	20	40	-	20	40	-	V/μS
Open Loop Voltage Gain ④	F = 15Hz R _L = 5KΩ	4	94	106	-	94	106	-	dB

NOTES:

- ① Unless otherwise noted C_C = 18pF, R_C = 2.2KΩ, ± V_{CC} = ± 150VDC.
- ② Derate maximum supply voltage 0.5V/°C below T_C = + 25°C. No derating is needed above T_C = 25°C.
- ③ A_V = -10V/V measured in false summing junction circuit.
- ④ Guaranteed by design but not tested. Typical parameters are representative of actual device performance but are for reference only.
- ⑤ Industrial grade and "E" suffix devices shall be tested to subgroups 1 and 4 unless otherwise specified.
- ⑥ Military grade devices ("B" suffix) shall be 100% tested to subgroups 1,2,3 and 4.
Subgroups 5 and 6 testing available upon request.
Subgroup 1,4 T_A = T_C = + 25°C
- ⑦ Subgroup 2,5 T_A = T_C = + 125°C
- ⑧ Subgroup 3,6 T_A = T_C = -55°C
- ⑨ Electrical specifications are derated for power supply voltages less than ± 50VDC.

APPLICATION NOTES

CURRENT LIMIT

Current limit resistor value can be calculated as follows:

$$RCL = 3/I_{LIM}$$

It is recommended that the user set up the value of current limit as close as possible to the maximum expected output current to protect the amplifier. The minimum value of current limit resistance is 33 ohms. The maximum practical value is 500 ohms. Current limit will vary with case temperature. Refer to the typical performance graphs as a guide. Since load current passes through the current limit resistor, a loss in output voltage swing will occur. The following formula approximates output voltage swing reduction:

$$V_R = I_O * RCL$$

When the device is in current limit, there will be spurious oscillations present on the negative half cycle. The frequency of the oscillation is application dependant and can not be predicted. Oscillation will cease when the device comes out of current limit. If current limit is not required simply short pin 3 and pin 4.

INPUT PROTECTION

Input protection circuitry within the MSK 158/159 will clip differential input voltages greater than 16 volts. The inputs are also protected against common mode voltages up to the supply rails as well as static discharge. There are 300 ohm current limiting resistors in series with each input. These resistors may become damaged in the event the input overload is capable of driving currents above 1mA. If severe overload conditions are expected, external input current limiting resistors are recommended.

OUTPUT SNUBBER NETWORK

A 100 ohm resistor and a 330pF capacitor connected in series from the output of the amplifier to ground is recommended for applications where load capacitance is less than 330pF. For larger values of load capacitance, the output snubber network may be omitted. If loop stability becomes a problem due to excessively high load capacitance, a 100 ohm resistor may be added between the output of the amplifier (the junction of RCL and pin 4) and the load. A small tradeoff with bandwidth must be made in this configuration. The graph below illustrates the effect of capacitive load on open loop gain. Note that the compensation capacitor must have a voltage rating greater than or equal to the total rail to rail power supply voltage.

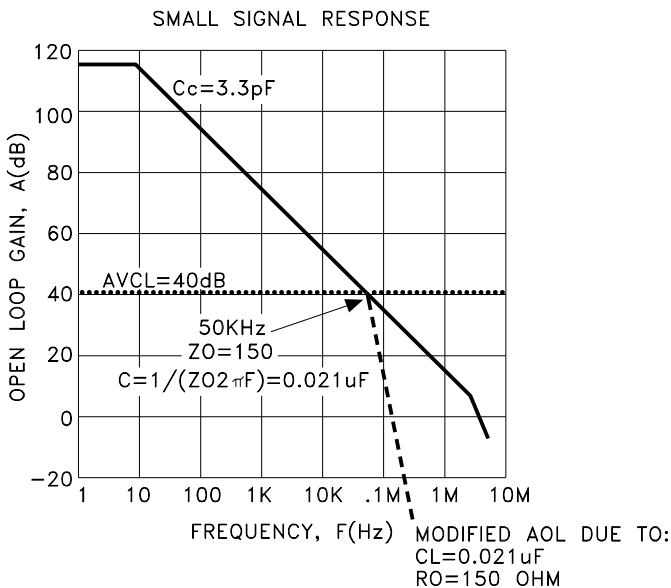

SAFE OPERATING AREA (SOA)

The MOSFET output stage of this power operational amplifier has two distinct limitations:

1. The current handling capability of the die metallization.
2. The junction temperature of the output MOSFET's.

NOTE: The output stage is protected against transient flyback. However, for protection against sustained, high energy flyback, external fast-recovery reverse biased diodes should be connected from the output to ground.

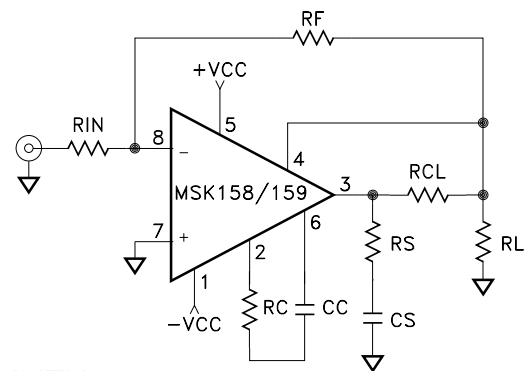
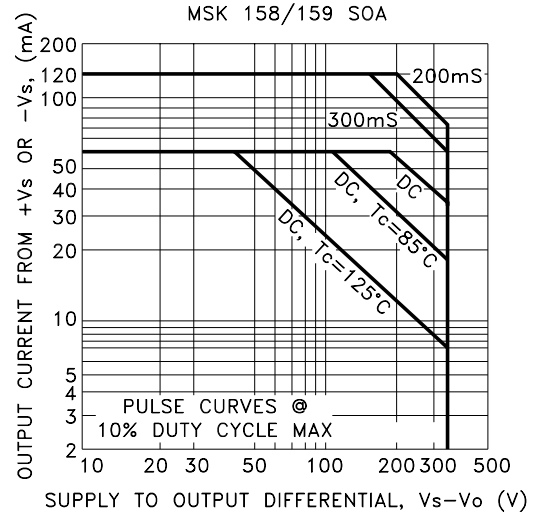

STABILITY

The MSK 158/159 has sufficient phase margin when compensated for unity gain to be stable with capacitive loads of at least 10nF. However, it is recommended that the parallel sum of the input and feedback resistor be 1000 ohms or less for closed loop gains of ten or less to minimize phase shift caused by the R-C network formed by the input resistor, feedback resistor and input capacitance. The user can tailor the performance of the MSK 158/159 to their application using the external compensation pins. The graphs of small signal gain and phase as well as the graphs of slow rate and power response demonstrate the effect of various forms of compensation. The compensation capacitor must be rated at 350 volts working voltage if maximum power supply voltages are used. The compensation resistor and capacitor lead lengths must be kept as short as possible to minimize spurious oscillations. A high quality NPO capacitor is recommended for the compensation capacitor.

EXTERNAL COMPENSATION

External compensation is only necessary at gains of 30V/V or less. For larger gains, the compensation resistor and capacitor may be omitted. An effective method of checking amplifier stability is to apply the worst case capacitive load to the output of the amplifier and drive a small signal square wave across it. If overshoot is less than 25%, the system will be stable.

TYPICAL PERFORMANCE CURVES

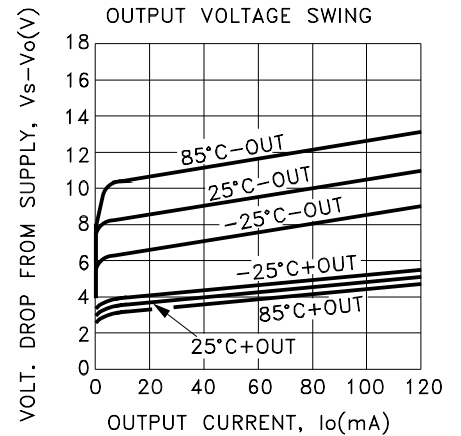
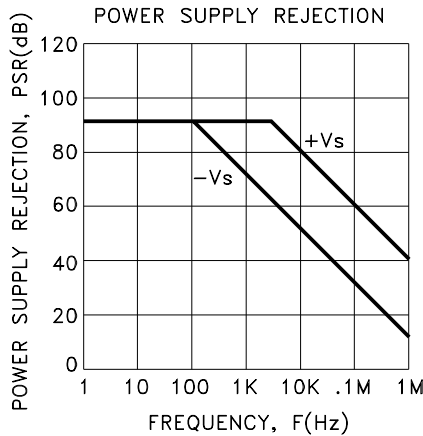
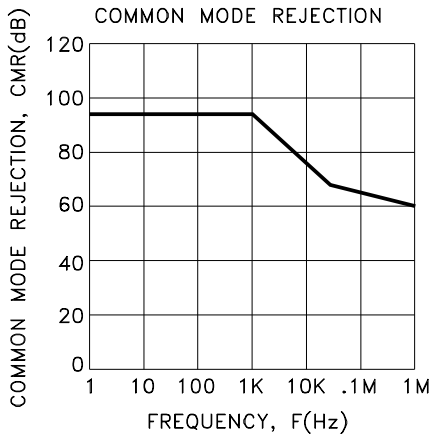
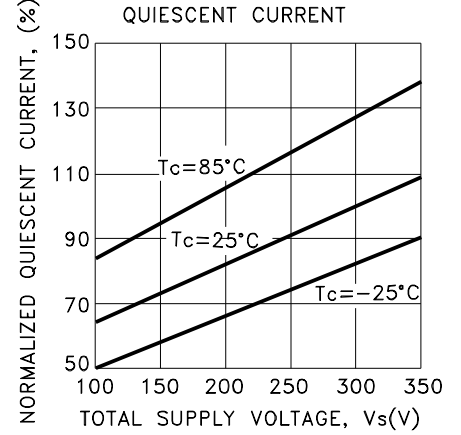
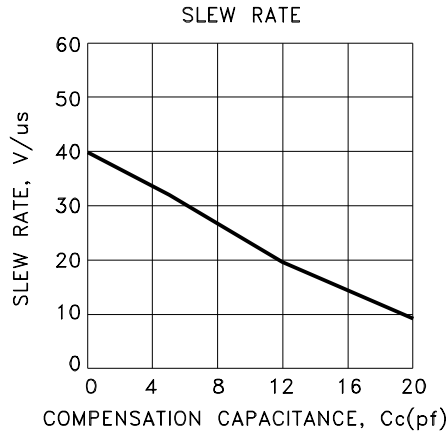
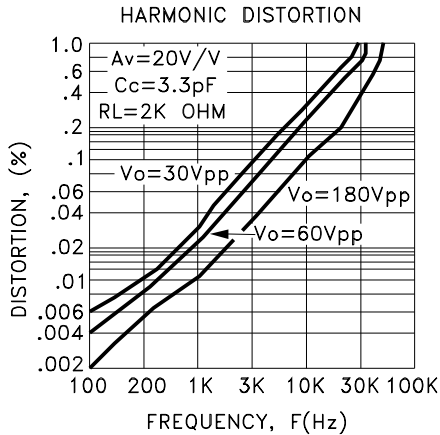
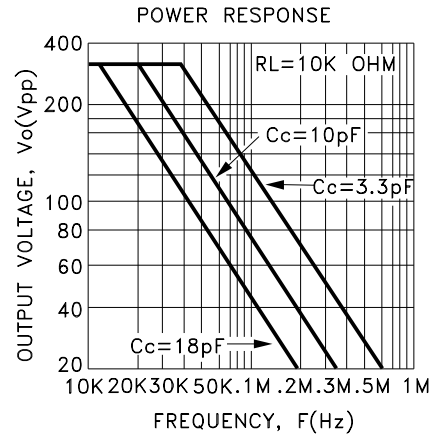
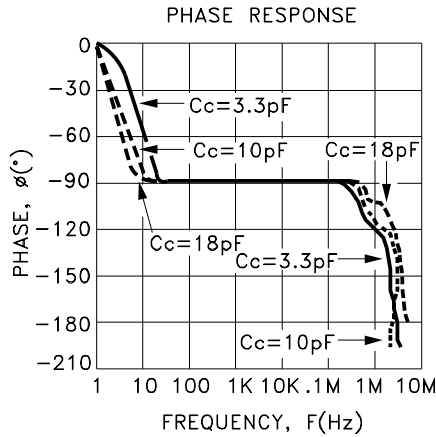
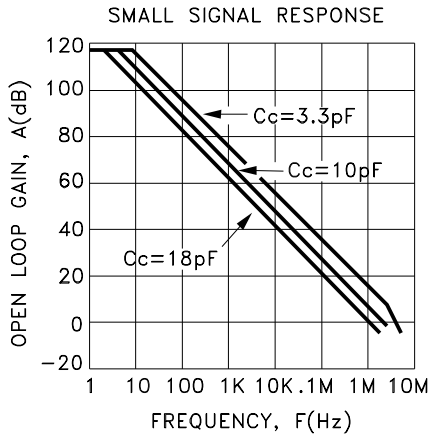
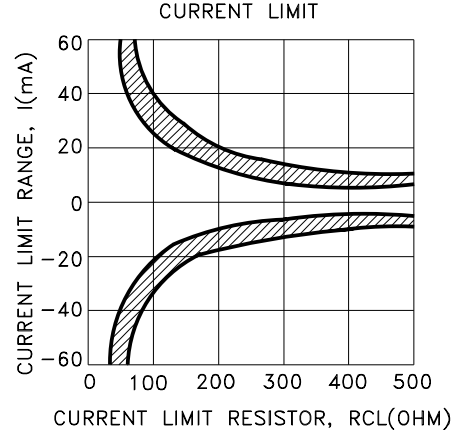
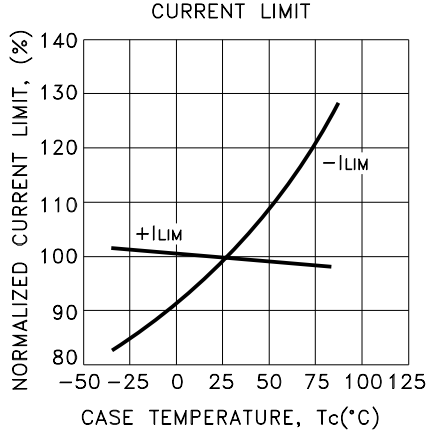
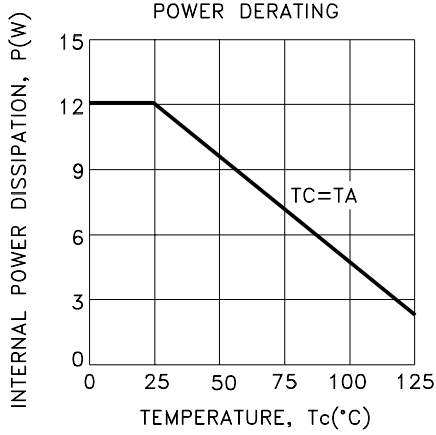

MECHANICAL SPECIFICATIONS

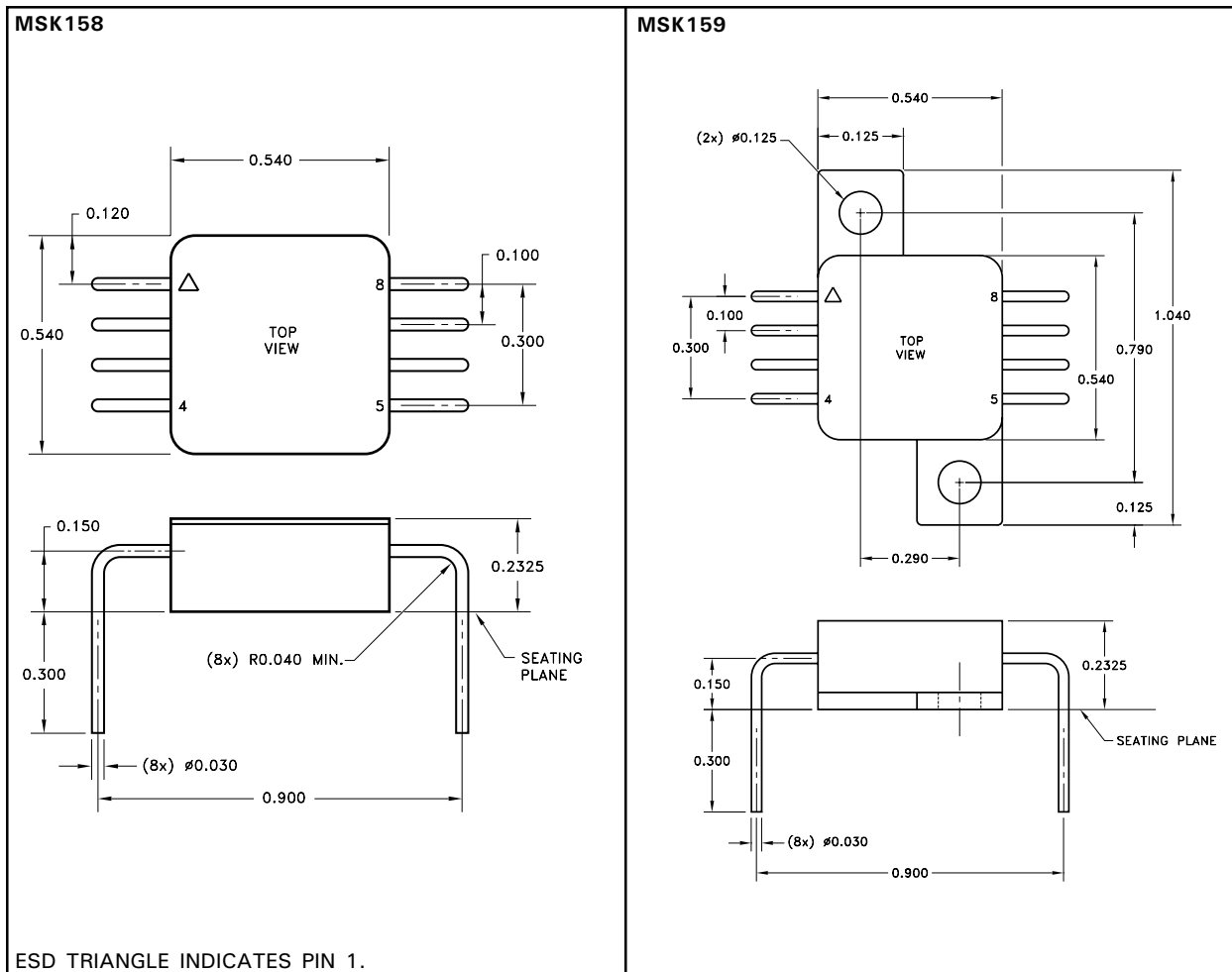

NOTE: ALL DIMENSIONS ARE ± 0.010 INCHES UNLESS OTHERWISE LABELED.

ORDERING INFORMATION

Part Number	Screening Level
MSK158	Industrial
MSK158E	Extended Reliability
MSK158B	Mil-PRF-38534 Class H
MSK159	Industrial
MSK159E	Extended Reliability
MSK159B	Mil-PRF-38534 Class H

M.S. Kennedy Corp.
 4707 Dey Road, Liverpool, New York 13088
 Phone (315) 701-6751
 FAX (315) 701-6752
www.mskennedy.com

The information contained herein is believed to be accurate at the time of printing. MSK reserves the right to make changes to its products or specifications without notice, however, and assumes no liability for the use of its products. Please visit our website for the most recent revision of this datasheet.