



M.S.KENNEDY CORP.

RAD TOLERANT ULTRA LOW DROPOUT ADJUSTABLE POSITIVE LINEAR REGULATOR

5900RH

4707 Dey Road Liverpool, N.Y. 13088

(315) 701-6751

FEATURES:

- Total Dose Tested to 300K RAD (136 RADS(Si)/SEC)
- Ultra Low Dropout for Reduced Power Consumption
- External Shutdown/Reset Function
- Latching Overload Protection
- Adjustable Output Using Two External Resistors
- Output Current Limit
- Surface Mount Package

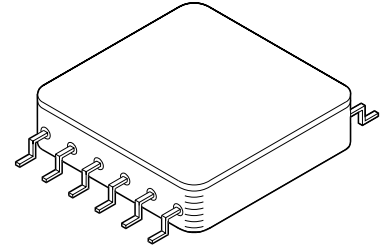

DESCRIPTION:

The MSK 5900RH is a rad tolerant adjustable linear regulator capable of delivering 4.0 amps of output current. Typical dropout is only 0.30 volts with a 1.5 amp load. An external shutdown/reset function is ideal for power supply sequencing. This device also has latching overload protection that requires no external current sense resistor. The MSK 5900RH is specifically designed for many space/satellite applications. The device is packaged in a hermetically sealed 12 pin flatpack that is lead formed for surface mount applications.

EQUIVALENT SCHEMATIC

www.DataSheet4U.com

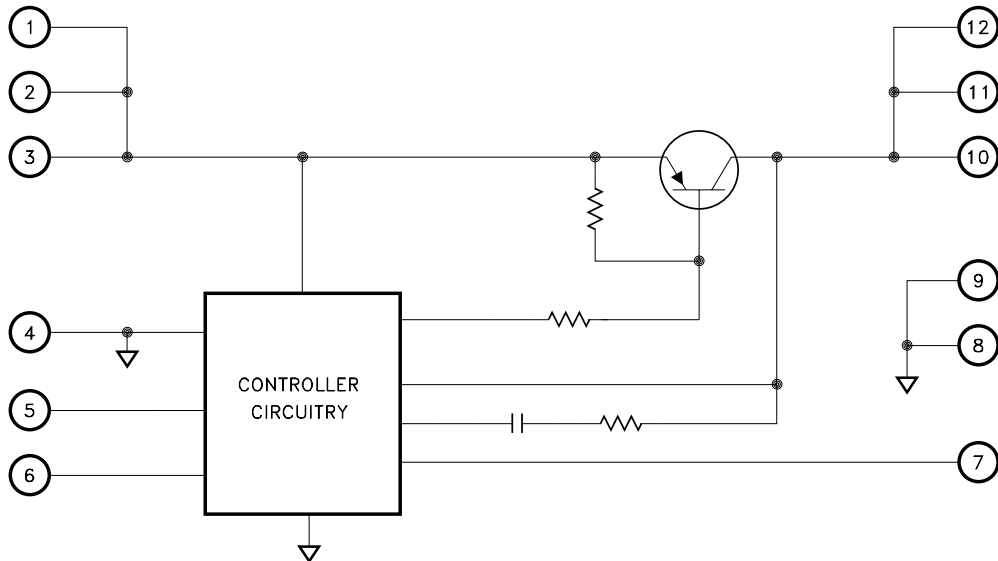

TYPICAL APPLICATIONS

- Satellite System Power Supplies
- Switching Power Supply Post Regulators
- Constant Voltage/Current Regulators
- Microprocessor Power Supplies

PIN-OUT INFORMATION

1 VIN A	12 VOUT A
2 VIN B	11 VOUT B
3 VIN C	10 VOUT C
4 GND 1	9 GND 2
5 Latch	8 GND 2
6 Shutdown	7 FB

ABSOLUTE MAXIMUM RATINGS ^⑩

$+V_{IN}$	Supply Voltage	+10V	T_{ST}	Storage Temperature Range	-65°C to +150°C
I_{OUT}	Output Current ^⑦	4A	T_{LD}	Lead Temperature Range	300°C
T_C	Case Operating Temperature Range			(10 Seconds)	
	MSK5900RH K/H/E.	-55°C to +125°C	P_D	Power Dissipation	See SOA Curve
	MSK5900RH.	-40°C to +85°C	T_C	Junction Temperature	150°C

ELECTRICAL SPECIFICATIONS

Parameter	Test Conditions ^{①⑨}	Group A Subgroup	MSK5900K/H/E			MSK5900			Units
			Min.	Typ.	Max.	Min.	Typ.	Max.	
Input Voltage Range ^{②⑧}	$10mA \leq I_{OUT} \leq 1.0A$	1	2.9	-	7.5	2.9	-	7.5	V
		2,3	2.9	-	7.5	-	-	-	V
Feedback Voltage	$10mA \leq I_{OUT} \leq 1.0A$ $R_1 = 187\Omega$	1	1.225	1.265	1.305	1.202	1.265	1.328	V
		2,3	1.225	-	1.305	-	-	-	V
Feedback Pin Current ^②	$V_{FB} = 1.265V$ $10mA \leq I_{OUT} \leq 1.0A$	1,2,3	0	-	5.0	0	-	5.0	μA
Quiescent Current	$V_{IN} = 7.5V$ Not Including I_{OUT}	1	-	14	20	-	14	20	mA
		2,3	-	14	20	-	-	-	mA
Line Regulation	$I_{OUT} = 10mA$ $2.8V \leq V_{IN} \leq 7.5V$ $R_1 = 187\Omega$	1	-	± 0.01	± 0.50	-	0.01	± 0.60	% V_{OUT}
		2,3	-	-	± 0.50	-	-	-	% V_{OUT}
Load Regulation	$10mA \leq I_{OUT} \leq 1.0A$	1	-	± 0.06	± 0.80	-	0.06	± 1.0	% V_{OUT}
		2,3	-	-	± 0.80	-	-	-	% V_{OUT}
Dropout Voltage	Delta FB = 1% $I_{OUT} = 1.0A$	1	-	0.22	0.70	-	0.22	0.75	V
		2,3	-	0.26	0.70	-	-	-	V
Minimum Output Current ^②	$2.8V \leq V_{IN} \leq 7.5V$ $R_1 = 187\Omega$	1	-	8	10	-	8	10	mA
		2,3	-	9	10	-	-	-	mA
Output Voltage Range ^②	$V_{IN} = 7.5V$	-	1.5	-	6.8	1.5	-	6.7	V
Output Current Limit ^⑦	$V_{IN} = 4.4V$ $V_{OUT} = 3.3V$	1	1.5	1.75	2.0	1.3	1.75	2.2	A
		2,3	1.3	1.75	2.2	-	-	-	A
Shutdown Threshold	$V_{OUT} \leq 0.2V$ (OFF) $V_{OUT} = \text{Nominal}$ (ON)	1	1.0	1.3	1.6	1.0	1.3	1.6	V
		2,3	1.0	1.3	1.6	-	-	-	V
Shutdown Hysteresis	Difference between voltage threshold of V_{SDI} (ON) and V_{SDI} (OFF)	1	-	0.02	0.2	-	0.02	0.2	V
		2,3	-	0.03	0.2	-	-	-	V
Ripple Rejection ^②	$f = 1KHz$ to $10KHz$ $10mA \leq I_{OUT} \leq 1.0A$ $1.0V = V_{IN} - V_{OUT}$	4	20	-	-	20	-	-	dB
		5,6	20	-	-	-	-	-	dB
Phase Margin ^②	$I_{OUT} = 450mA$	4,5,6	30	70	-	30	70	-	degrees
Gain Margin ^②	$I_{OUT} = 450mA$	4,5,6	10	18	-	10	18	-	dB
Equivalent Noise Voltage ^②	Referred to Feedback Pin	4,5,6	-	-	50	-	-	50	μV_{RMS}
Thermal Resistance ^②	Junction to Case @ 125°C Output Device	-	-	6.9	7.5	-	6.9	7.8	°C/W

NOTES:

- ① Unless otherwise specified, $V_{IN} = 5.0V$, $R_1 = 1.62K$, $V_{SHUTDOWN} = 0V$ and $I_{OUT} = 10mA$. See Figure 2, typical application circuit.
- ② Guaranteed by design but not tested. Typical parameters are representative of actual device performance but are for reference only.
- ③ Industrial grade and "E" suffix devices shall be tested to subgroups 1 and 4 unless otherwise requested.
- ④ Military grade devices ("H" suffix) shall be 100% tested to subgroups 1,2,3 and 4.
- ⑤ Subgroup 5 and 6 testing available upon request.
- ⑥ Subgroup 1,4 $T_C = +25^\circ C$
Subgroup 2,5 $T_C = +125^\circ C$
Subgroup 3,6 $T_A = -55^\circ C$
- ⑦ Output current limit is dependent upon the values of V_{IN} and V_{OUT} . See Figure 1 and typical performance curves.
- ⑧ Minimum V_{IN} at $-55^\circ C$ and $I_{OUT} = 1.0A$ is 4.0V due to current limit circuitry.
- ⑨ Consult factory for post radiation limits.
- ⑩ Continuous operation at or above absolute maximum ratings may adversely effect the device performance and/or life cycle.

APPLICATION NOTES

PIN FUNCTIONS

VIN A,B,C - These pins provide power to all internal circuitry including bias, start-up, thermal limit and overcurrent latch. Input voltage range is 2.9V to 7.5V. All three pins must be connected for proper operation.

GND1 - Internally connected to input ground, these pins should be connected externally by the user to the circuit ground and the GND2 pins.

LATCH - The MSK 5900RH LATCH pin is used for both current limit and thermal limit. A capacitor between the LATCH pin and ground sets a time out delay in the event of an over current or short circuit condition. The capacitor is charged to approximately 1.6V from a 7.2 μ A (nominal) current source. Exceeding the thermal limit charges the latch capacitor from a larger current source for a near instant shutdown. Once the latch capacitor is charged the device latches off until the latch is reset. Momentarily pull the LATCH pin low, toggle the shutdown pin high then low or cycle the power to reset the latch. Toggling the shutdown pin or cycling the power both disable the device during the reset operation (see SHUTDOWN pin description). Pulling the LATCH pin low immediately enables the device for as long as the LATCH pin is held low plus the time delay to recharge the latch capacitor whether or not the fault has been corrected. Disable the latch feature by tying the LATCH pin low. With the LATCH pin held low the thermal limit feature is disabled and the current limit feature will force the output voltage to droop but remain active if excessive current is drawn.

SHUTDOWN - There are two functions to the SHUTDOWN pin. It may be used to disable the output voltage or to reset the LATCH pin. To activate the shutdown/reset functions the user must apply a voltage greater than 1.3V to the SHUTDOWN pin. The output voltage will turn on when the SHUTDOWN pin is pulled below the threshold voltage. If the SHUTDOWN pin is not used, it should be connected to ground.

FB - The FB pin is the inverting input of the internal error amplifier. The non-inverting input is connected to an internal 1.265V reference. This error amplifier controls the drive to the output transistor to force the FB pin to 1.265V. An external resistor divider is connected to the output, FB pin and ground to set the output voltage.

GND2 - Internally connected to output ground, these pins should be connected externally by the user to the circuit ground and the GND1 pins.

VOUT A,B,C - These are the output pins for the device. All three pins must be connected for proper operation.

POWER SUPPLY BYPASSING

To maximize transient response and minimize power supply transients it is recommended that a 33 μ F minimum tantalum capacitor is connected between VIN and ground. A 0.1 μ F ceramic capacitor should also be used for high frequency bypassing.

OUTPUT CAPACITOR SELECTION

Output capacitors are required to maintain regulation and stability. A 220 μ F surface mount tantalum capacitor in parallel with a 0.1 μ F ceramic capacitor from the output to ground should suffice under most conditions. If the user finds that tighter voltage regulation is needed during output transients, more capacitance may be added. If more capacitance is added to the output, the bandwidth may suffer. ESR of the output capacitors should be maintained at 0.1 Ω to 1 Ω to maintain adequate gain and phase margin. See the gain and phase curves.

OVERCURRENT LATCH-OFF/LATCH PIN CAPACITOR SELECTION

As previously mentioned, the LATCH pin provides over current/output short circuit protection with a timed latch-off circuit. Reference the LATCH pin description note. The latch off time out is determined with an external capacitor connected from the LATCH pin to ground. The time-out period is equal to the time it takes to charge this external capacitor from 0V to 1.6V. The latch charging current is provided by an internal current source. This current is a function of input voltage and temperature (see latch charging current curve). For instance, at 25 $^{\circ}$ C, the latch charging current is 7.2 μ A at VIN = 3V and 8 μ A at VIN = 7V.

In the latch-off mode, some additional current will be drawn from the input. This additional latching current is also a function of input voltage and temperature (see latching current curves).

FIGURE 1

THERMAL LIMITING

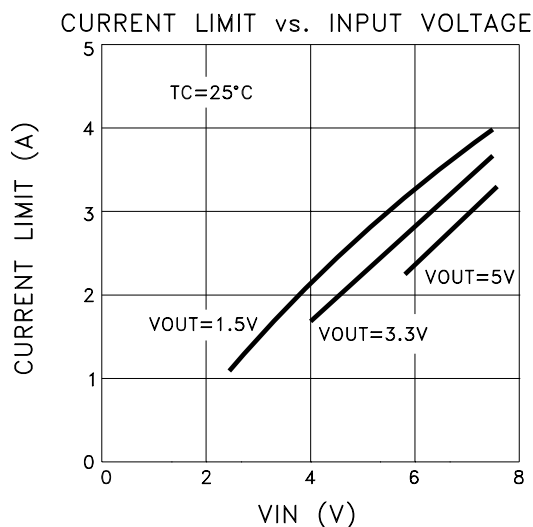

The MSK 5900RH current limit function is directly affected by the input and output voltages. Figure 1 illustrates the relationship between VIN and ICL for three output voltages.

APPLICATION NOTES CONT.

THERMAL LIMITING

The MSK 5900RH control circuitry has a thermal shutdown temperature of approximately 150°C. This thermal shutdown can be used as a protection feature, but for continuous operation, the junction temperature of the pass transistor must be maintained below 150°C. Proper heat sink selection is essential to maintain these conditions. Exceeding the thermal limit activates the latch feature of the MSK 5900RH. See LATCH pin description for instructions to reset the latch or disable the latch feature.

HEAT SINK SELECTION

To select a heat sink for the MSK 5900RH, the following formula for convective heat flow may be used.

Governing Equation:

$$T_J = P_D \times (R_{\theta JC} + R_{\theta CS} + R_{\theta SA}) + T_A$$

Where

- T_J = Junction Temperature
- P_D = Total Power Dissipation
- R_{θJC} = Junction to Case Thermal Resistance
- R_{θCS} = Case to Heat Sink Thermal Resistance
- R_{θSA} = Heat Sink to Ambient Thermal Resistance
- T_A = Ambient Temperature

$$\text{Power Dissipation} = (V_{IN} - V_{OUT}) \times I_{OUT}$$

Next, the user must select a maximum junction temperature. The absolute maximum allowable junction temperature is 150°C. The equation may now be rearranged to solve for the required heat sink to ambient thermal resistance (R_{θSA}).

Example:

An MSK 5900RH is connected for V_{IN} = +5V and V_{OUT} = +3.3V. I_{OUT} is a continuous 1A DC level. The ambient temperature is +25°C. The maximum desired junction temperature is +125°C.

R_{θJC} = 7.5°C/W and R_{θCS} = 0.15°C/W for most thermal greases

$$\text{Power Dissipation} = (5V - 3.3V) \times (1A) = 1.7\text{Watts}$$

Solve for R_{θSA}:

$$R_{\theta SA} = \left[\frac{125^\circ\text{C} - 25^\circ\text{C}}{1.7\text{W}} \right] - 7.5^\circ\text{C/W} - 0.15^\circ\text{C/W} = 51.2^\circ\text{C/W}$$

In this example, a heat sink with a thermal resistance of no more than 51°C/W must be used to maintain a junction temperature of no more than 125°C.

TYPICAL APPLICATIONS CIRCUIT

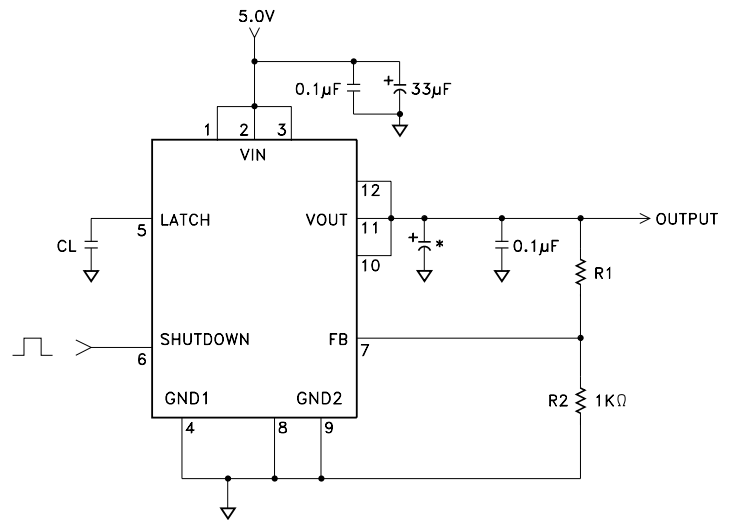

* 4 PIECES AVX PART NUMBER
TAZH476K010C (CWR09F8476)

$$V_{OUT} = 1.265(1 + R1/R2)$$

OUTPUT VOLTAGE SELECTION

As noted in the above typical applications circuit, the formula for output voltage selection is

$$V_{OUT} = 1.265 \left[1 + \frac{R1}{R2} \right]$$

A good starting point for this output voltage selection is to set R2 = 1K. By rearranging the formula it is simple to calculate the final R1 value.

$$R1 = R2 \left[\frac{V_{OUT}}{1.265} - 1 \right]$$

Table 1 below lists some of the most probable resistor combinations based on industry standard usage.

TABLE 1

OUTPUT VOLTAGE (V)	R2 (Ω)	R1 (nearest 1%) (Ω)
1.5	1K	187
1.8	1K	422
2.0	1K	576
2.5	1K	976
2.8	1K	1.21K
3.3	1K	1.62K
4.0	1K	2.15K
5.0	1K	2.94K

TYPICAL PERFORMANCE CURVES

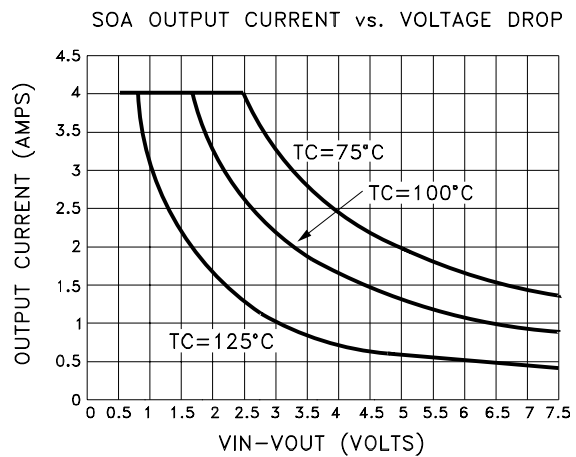
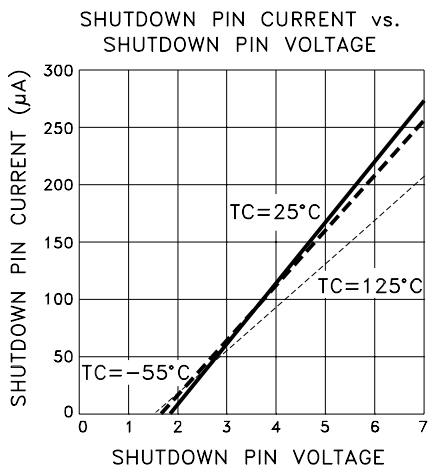
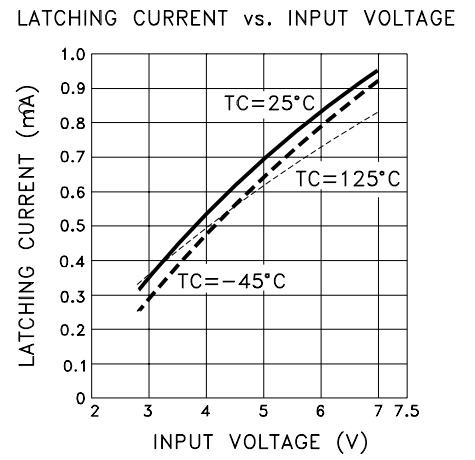
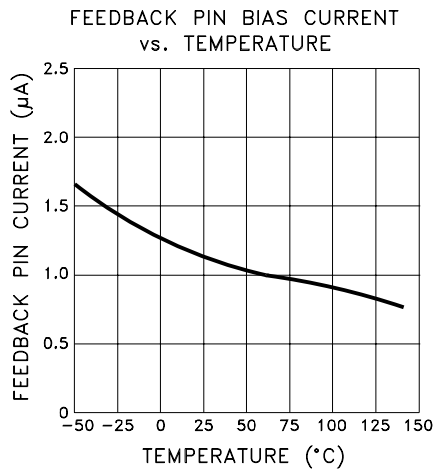
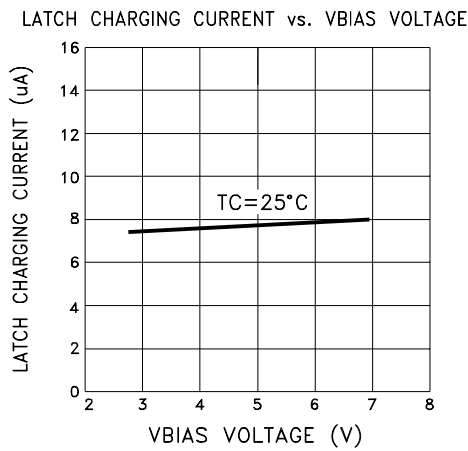
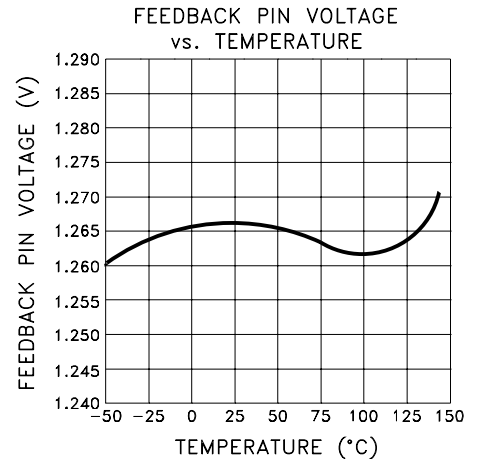
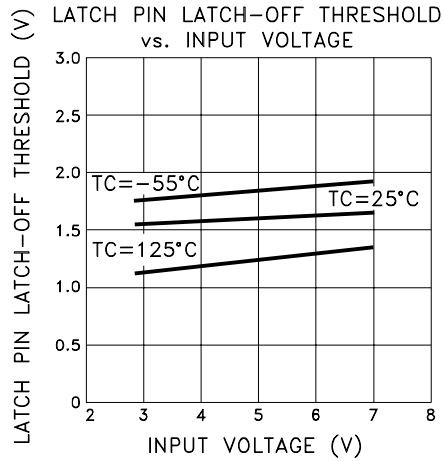
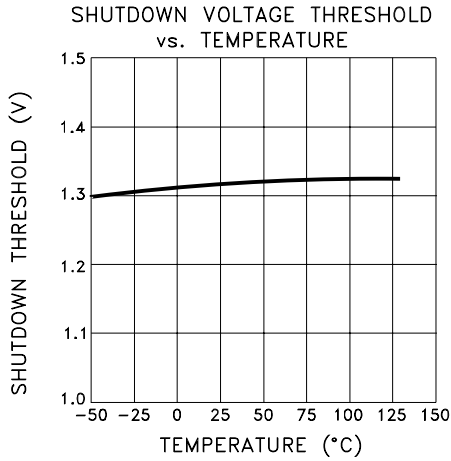

TYPICAL PERFORMANCE CURVES

GAIN AND PHASE RESPONSE (SEE TYPICAL APPLICATION CIRCUIT FOR CAPACITIVE LOAD)

MSK5900RH GAIN AND PHASE vs. FREQUENCY

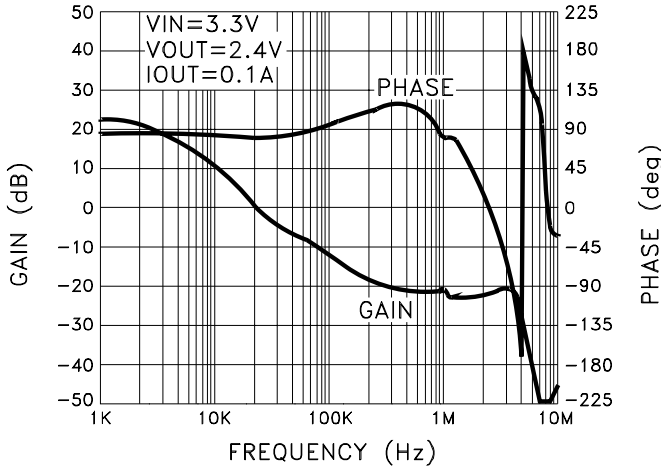

MSK5900RH GAIN AND PHASE vs. FREQUENCY

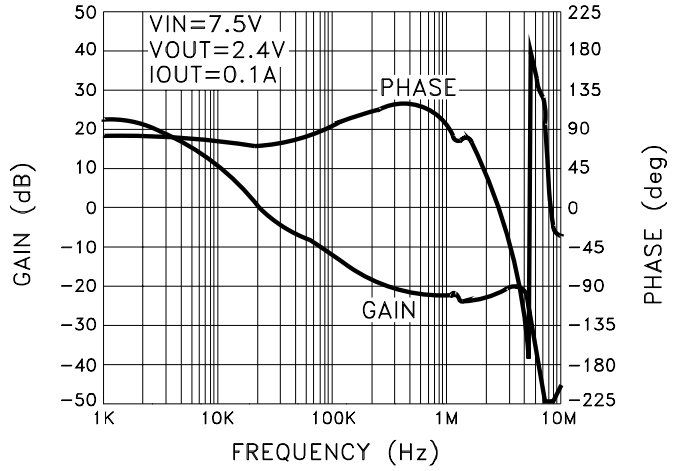

MSK5900RH GAIN AND PHASE vs. FREQUENCY

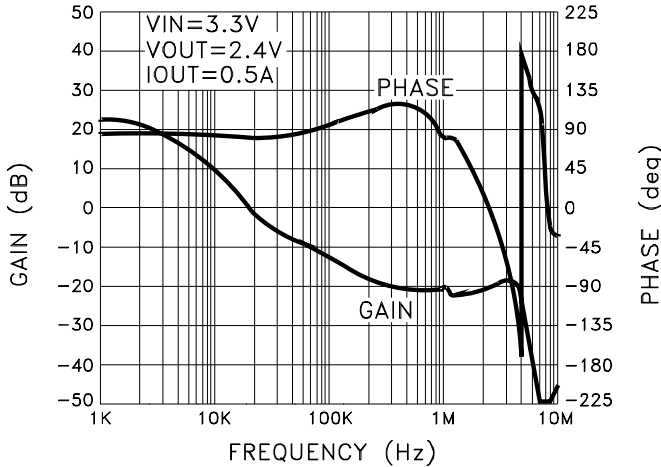

MSK5900RH GAIN AND PHASE vs. FREQUENCY

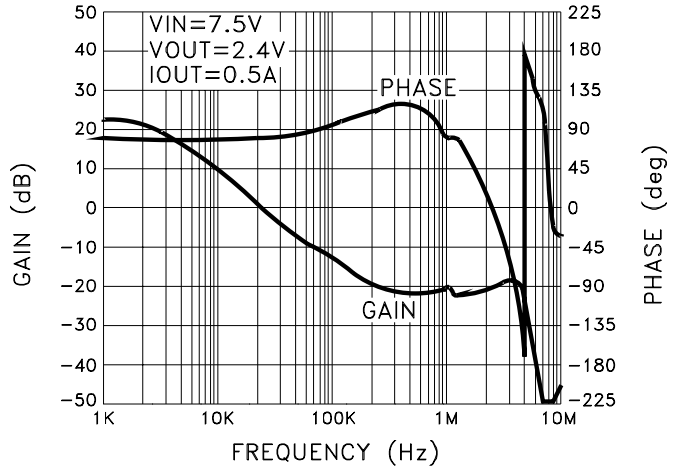

MSK5900RH GAIN AND PHASE vs. FREQUENCY

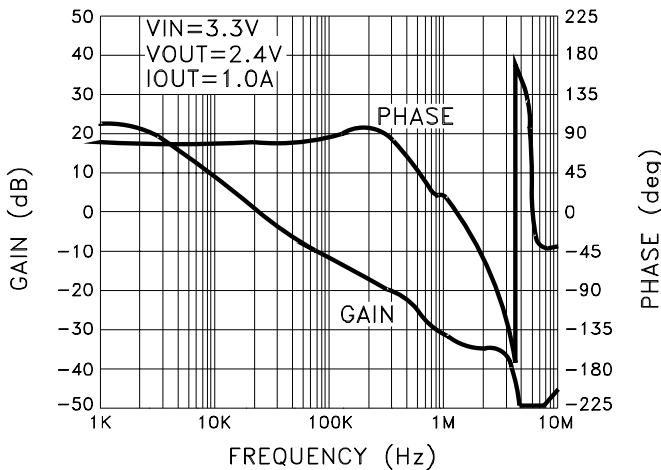

MSK5900RH GAIN AND PHASE vs. FREQUENCY

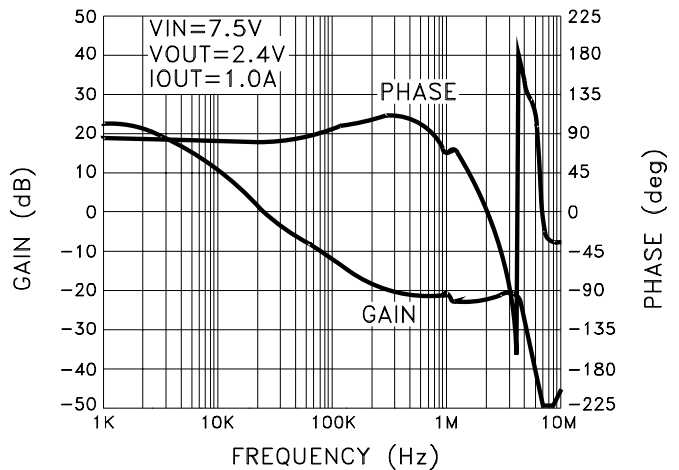

RADIATION PERFORMANCE CURVES

QUIESCENT CURRENT

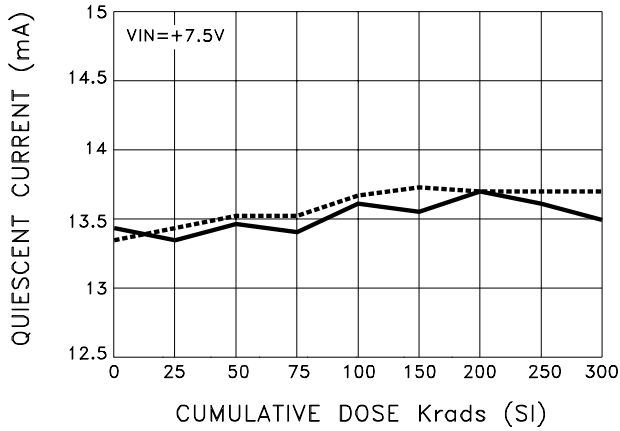

LINE REGULATION

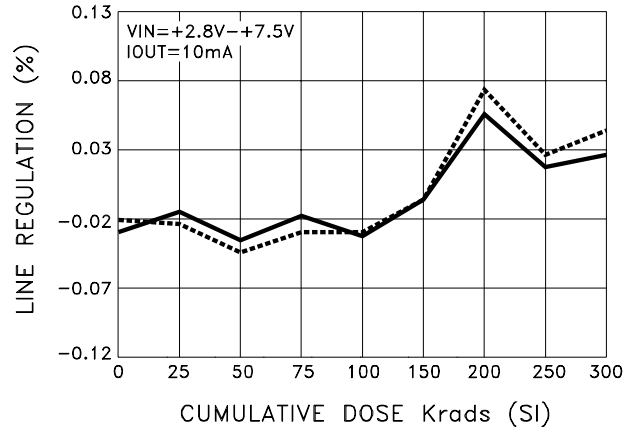

LOAD REGULATION

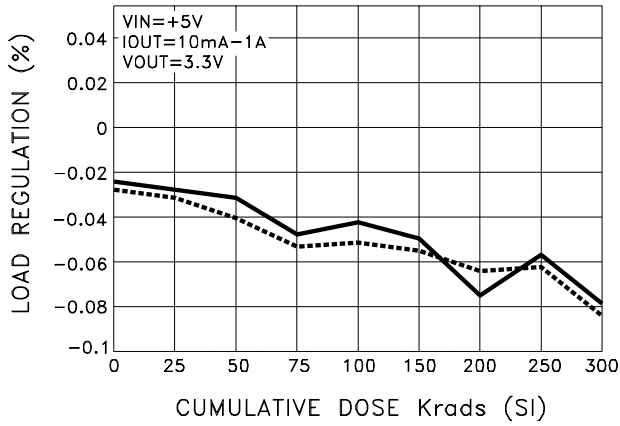

DROPOUT VOLTAGE

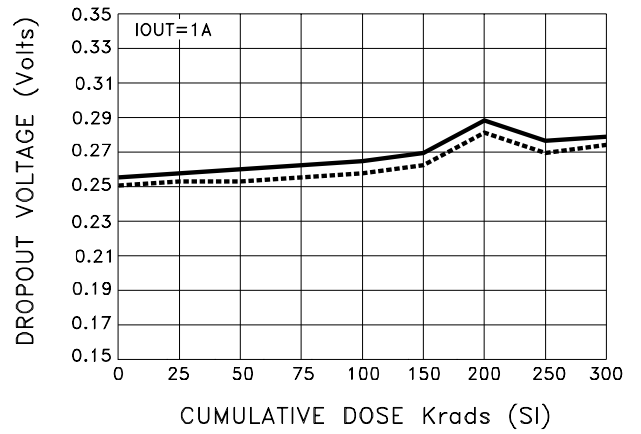

FEEDBACK VOLTAGE

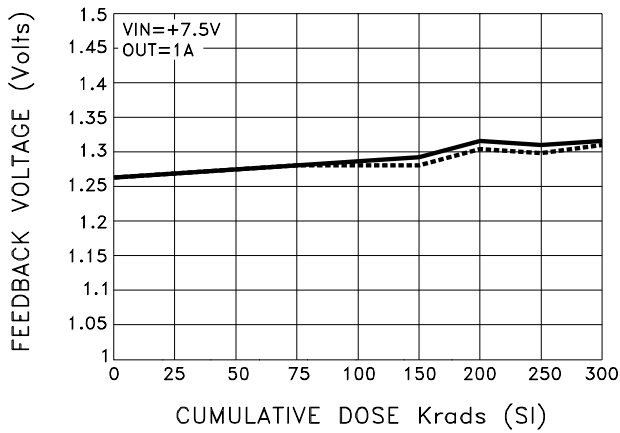

OUTPUT CURRENT LIMIT

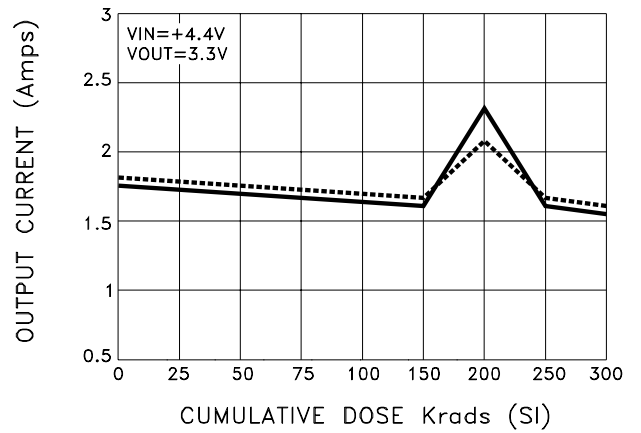

— AVERAGE BIASED
 AVERAGE UNBIASED

NOTE: All radiation performance curve test conditions are in accordance with the electrical specifications table (page 2). See RAD report for bias and dose rate.

MECHANICAL SPECIFICATIONS

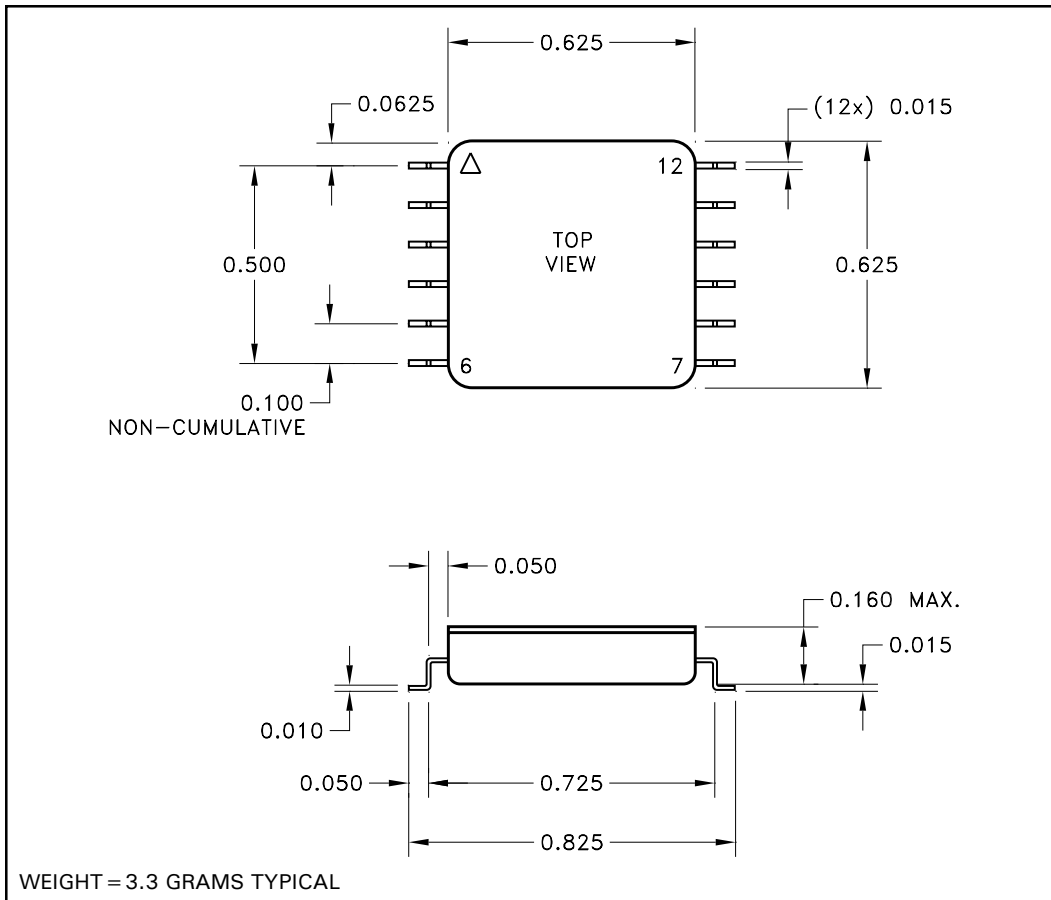

ALL DIMENSIONS ARE ± 0.010 INCHES UNLESS OTHERWISE LABELED.
ESD Triangle indicates pin 1.

ORDERING INFORMATION

Part Number	Screening Level
MSK5900RH	INDUSTRIAL
MSK5900ERH	EXTENDED RELIABILITY
MSK5900HRH	MIL-PRF-38534 CLASS H
MSK5900KRH	MIL-PRF-38534 CLASS K

The above example is a Military grade hybrid.

M.S. Kennedy Corp.
4707 Dey Road, Liverpool, New York 13088
Phone (315) 701-6751
FAX (315) 701-6752
www.mskennedy.com

The information contained herein is believed to be accurate at the time of printing. MSK reserves the right to make changes to its products or specifications without notice, however, and assumes no liability for the use of its products.

Please visit our website for the most recent revision of this datasheet.

Contact MSK for MIL-PRF-38534 Class H, Class K and Appendix G (radiation) status.