



M.S.KENNEDY CORP.

**DUAL RAD HARD
+/-
VOLTAGE REGULATOR**

**5911RH
SERIES**

4707 Dey Road Liverpool, N.Y. 13088

(315) 701-6751

FEATURES:

- Total Dose Tested to 300K RAD(Si)
- Internal Thermal Overload Protection
- Output Current to 1.5 Amps
- Output Voltage Internally Trimmed to $\pm 1\%$ Accuracy
- Lead Form Options: Straight and Gull Wing
- Alternate Voltage Combinations Available

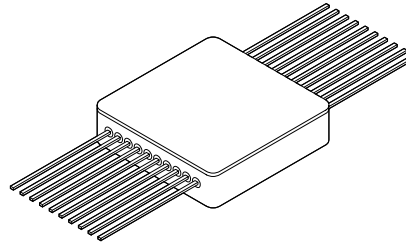

MSK591XRH

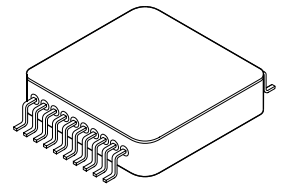

MSK591XRHG

DESCRIPTION:

The MSK 5911RH series are dual Radiation Hardened +/- voltage regulators offering low dropout and output accuracy to $\pm 1\%$ maximum. Excellent line and load regulation characteristics ensure highly accurate performance. The MSK 5911RH series regulators are equipped with internal thermal overload protection. The devices are packaged in a space efficient 20 pin flatpack with two lead form options, straight and gull wing.

EQUIVALENT SCHEMATIC

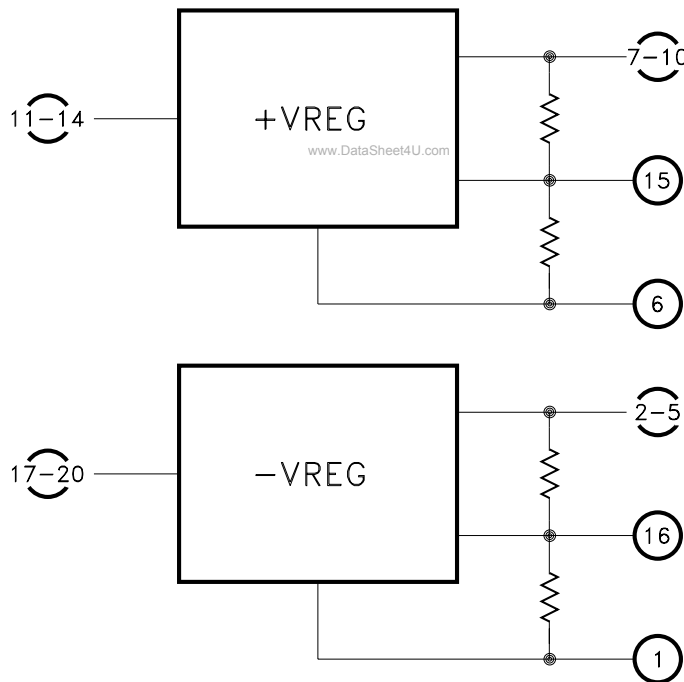

TYPICAL APPLICATIONS

- Switching Power Supply Post Regulators
- Constant Voltage/Current Regulators
- High Efficiency Linear Regulators

PIN-OUT INFORMATION

1 -VRTN	20 -VIN
2 -VOUT	19 -VIN
3 -VOUT	18 -VIN
4 -VOUT	17 -VIN
5 -VOUT	16 -Ccomp
6 +VRTN	15 +Ccomp
7 +VOUT	14 +VIN
8 +VOUT	13 +VIN
9 +VOUT	12 +VIN
10 +VOUT	11 +VIN

ABSOLUTE MAXIMUM RATINGS

⑧

+V _{IN}	+ Input Voltage (V _{IN} -V _{OUT})	+40VDC
-V _{IN}	-Input Voltage (V _{IN} -V _{OUT})	-30VDC
P _D	Power Dissipation	Internally Limited
+I _{OUT}	+ Output Current	1.5A
-I _{OUT}	-Output Current	1.5A
T _J	Junction Temperature	+150°C

T _{ST}	Storage Temperature Range	-65°C to +150°C
T _{LD}	Lead Temperature Range (10 Seconds)	300°C
T _C	Case Operating Temperature	
	MSK 5911RH-5919RH	-40°C to +85°C
	MSK 5911RH-5919RH(K/H/E)	-55°C to +125°C

ELECTRICAL SPECIFICATIONS

Parameter	Test Conditions ⑦	Group A Subgroup ④	MSK 591XRH K/H/E ③			MSK 591XRH ②			Units
			Min.	Typ.	Max.	Min.	Typ.	Max.	
POSITIVE OUTPUT REGULATORS:									
Output Voltage Tolerance	I _{OUT} = 10mA; V _{IN} = V _{OUT} + 3V	1	-	±0.2	±1.0	-	±0.2	±1.5	%
		2,3	-	±0.8	±3.0	-	-	-	%
Dropout Voltage	I _{OUT} = 0.5A; ΔV _{OUT} = 1%	1	-	1.6	3.0	-	1.6	3.5	V
		2,3	-	1.9	3.0	-	-	-	V
Load Regulation	10mA ≤ I _{OUT} ≤ 0.5A V _{IN} = V _{OUT} + 3V	1	-	±0.2	±2.0	-	±0.2	±2.5	%
		2,3	-	±0.4	±2.5	-	-	-	%
Line Regulation	I _{OUT} = 10mA V _{OUT} + 3V ≤ V _{IN} ≤ 35V	1	-	±0.6	±1.5	-	±0.6	±2.0	%
		2,3	-	±1.0	±2.5	-	-	-	%
Thermal Resistance ①	JUNCTION TO CASE @ 125°C	-	-	9.5	10.5	-	9.5	11.0	°C/W
NEGATIVE OUTPUT REGULATORS:									
Output Voltage Tolerance	I _{OUT} = 10mA; V _{IN} = V _{OUT} - 3V	1	-	±0.2	±1.0	-	±0.2	±1.5	%
		2,3	-	±0.8	±3.0	-	-	-	%
Dropout Voltage	I _{OUT} = 0.5A; ΔV _{OUT} = 1%	1	-	1.9	3.0	-	1.9	3.0	V
		2,3	-	1.5	3.0	-	-	-	V
Load Regulation	10mA ≤ I _{OUT} ≤ 0.5A V _{IN} = V _{OUT} - 3V	1	-	±0.2	±2.0	-	±0.2	±2.5	%
		2,3	-	±0.4	±2.5	-	-	-	%
Line Regulation	I _{OUT} = 10mA -30V ≤ V _{IN} ≤ V _{OUT} - 3V	1	-	±0.1	±1.5	-	±0.1	±2.0	%
		2,3	-	±0.2	±2.5	-	-	-	%
Thermal Resistance ①	JUNCTION TO CASE @ 125°C	-	-	TBD	TBD	-	TBD	TBD	°C/W

NOTES:

- ① Guaranteed by design but not tested. Typical parameters are representative of actual device performance but are for reference only.
- ② Industrial grade and "E" suffix devices shall be tested to subgroup 1 unless otherwise specified.
- ③ Military grade devices shall be 100% tested to subgroups 1,2 and 3.
- ④ Subgroup 1 T_A = T_C = +25°C
Subgroup 2 T_A = T_C = +125°C
Subgroup 3 T_A = T_C = -55°C
- ⑤ Please consult the factory if alternate output voltages are required.
- ⑥ For positive regulator, output decoupled to ground using 1μF minimum tantalum capacitor unless otherwise specified. For negative regulator, output decoupled to ground using 1μF minimum tantalum capacitor.
- ⑦ Consult factory for post radiation limits.
- ⑧ Continuous operation at or above absolute maximum ratings may adversely effect the device performance and/or life cycle.

PART NUMBER ⑤	OUTPUT VOLTAGES	
	POSITIVE	NEGATIVE
MSK5911	5.0	5.0
MSK5912	5.0	5.2
MSK5913	12.0	5.0
MSK5914	12.0	12.0
MSK5915	15.0	15.0
MSK5916	15.0	5.0
MSK5917	5.0	12.0
MSK5918	5.0	15.0
MSK5919	10.0	10.0

APPLICATION NOTES

CAPACITOR SELECTION

POSITIVE REGULATOR

INPUT CAPACITOR:

An input bypass capacitor is recommended when using the MSK 5911 series regulators. This is especially true if the regulator is located farther than 6 inches from the power supply filter capacitors. For most applications a 1 μ F solid tantalum capacitor will be suitable.

OUTPUT CAPACITOR:

A minimum of a 1 μ F solid tantalum capacitor should also be used at the output to insure stability. Any increase of this output capacitor larger than 10 μ F will only improve output impedance.

+C_{COMP} CAPACITOR:

For improved ripple rejection, +C_{comp} can be bypassed to ground with a 10 μ F tantalum capacitor. This bypass capacitor will provide 80dB ripple rejection. Increased capacitance above 10 μ F does not improve the ripple rejection at frequencies above 120Hz. If the C_{comp} bypass capacitor is used, it may be necessary to add a protection diode to protect the regulator from capacitor discharge damage. See Typical Applications Circuit for clarification. If the bypass capacitor is not used, it should be left open since it is internally connected to the regulator.

NEGATIVE REGULATOR

INPUT CAPACITOR:

Once again, if the regulator will be farther than 6 inches from power supply filter capacitors, then an input capacitor will be required on the negative regulator. It is recommended that a 1 μ F solid tantalum capacitor be used.

OUTPUT CAPACITOR:

A minimum of a 1 μ F solid tantalum capacitor should also be used at the output to insure stability. Any increase of this output capacitor larger than 10 μ F will only improve output impedance.

-C_{COMP} CAPACITOR:

For improved ripple rejection, -C_{comp} can be bypassed to ground with a 10 μ F tantalum capacitor. This bypass capacitor will provide 66dB ripple rejection. Increased capacitance above 10 μ F does not improve the ripple rejection at frequencies above 120Hz. If the C_{comp} bypass capacitor is used, it may be necessary to add a protection diode to protect the regulator from capacitor discharge damage. See Typical Applications Circuit for clarification. If the bypass capacitor is not used, it should be left open since it is internally connected to the regulator.

TYPICAL APPLICATION CIRCUIT

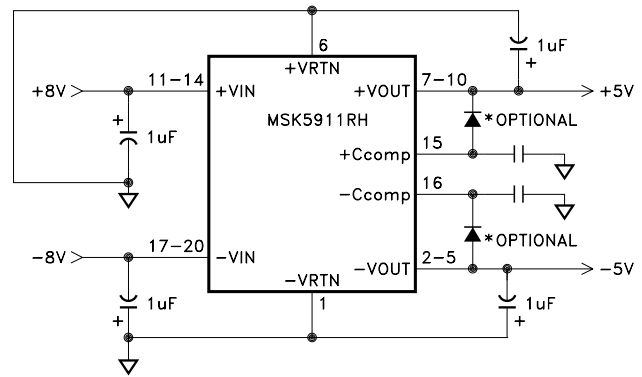

LOAD REGULATION

It is important to keep the output connection between the regulator and the load as short as possible since this directly affects the load regulation. For example, if 20 gauge wire were used which has a resistance of about 0.008 ohms per foot, this would result in a drop of 8mV/ft at 1Amp of load current. It is also important to follow the capacitor selection guidelines to achieve best performance.

HEAT SINKING

To determine if a heat sink is required for your application and if so, what type, refer to the thermal model and governing equation below.

$$\text{Governing Equation: } T_j = P_d \times (R_{\theta jc} + R_{\theta cs} + R_{\theta sa}) + T_a$$

WHERE

- T_j = Junction Temperature
- P_d = Total Power Dissipation
- R_{θjc} = Junction to Case Thermal Resistance
- R_{θcs} = Case to Heat Sink Thermal Resistance
- R_{θsa} = Heat Sink to Ambient Thermal Resistance
- T_c = Case Temperature
- T_a = Ambient Temperature
- T_s = Heat Sink Temperature

EXAMPLE:

This example demonstrates an analysis where the output currents are at 0.5 amp each and both inputs are 8V.

Conditions for MSK 5911RH:

$$+V_{in} = +8.0V; I_{out} = 0.5A \text{ Positive Regulator}$$

- 1.) Assume 45° heat spreading model.
- 2.) Find positive regulator power dissipation:

$$\begin{aligned} P_d &= (V_{in} - V_{out})(I_{out}) \\ P_d &= (+8V - 5V)(0.5A) \\ P_d &= 1.5W \end{aligned}$$

- 3.) For conservative design, set T_j = +125°C Max.
- 4.) For this example, worst case T_a = +90°C.
- 5.) R_{θjc} = 10.5°C/W from the Electrical Specification Table.
- 6.) R_{θcs} = 0.15°C/W for most thermal greases.
- 7.) Rearrange governing equation to solve for R_{θsa}:

$$\begin{aligned} R_{\theta sa} &= ((T_j - T_a)/P_d) - (R_{\theta jc}) - (R_{\theta cs}) \\ &= (125^\circ\text{C} - 90^\circ\text{C})/1.5W - 10.5^\circ\text{C/W} - 0.15^\circ\text{C/W} \\ &= 12.7^\circ\text{C/W} \end{aligned}$$

The same exercise must be performed for the negative regulator.

TYPICAL PERFORMANCE CURVES

POSITIVE QUIESCENT CURRENT

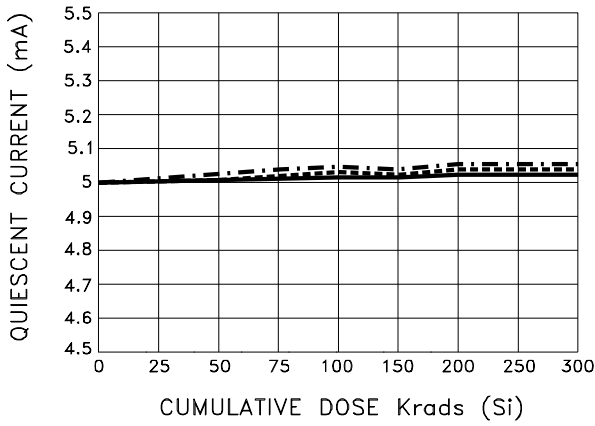

POSITIVE OUTPUT VOLTAGE TOLERANCE

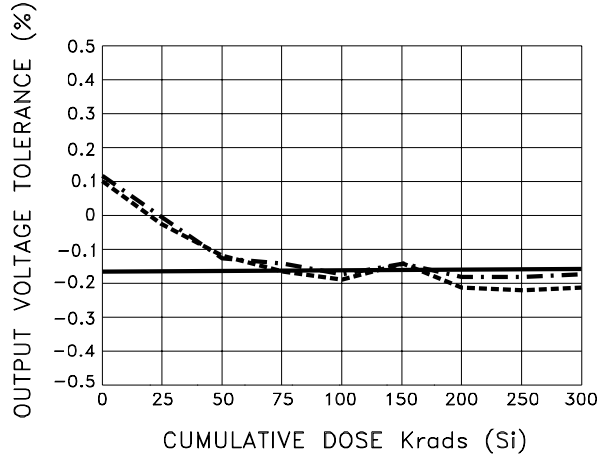

POSITIVE DROPOUT VOLTAGE

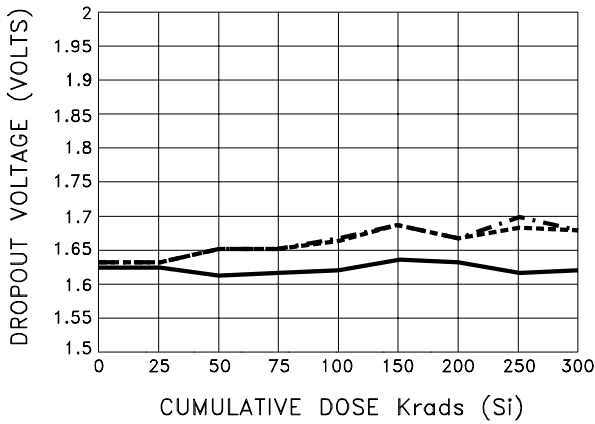

POSITIVE LINE REGULATION

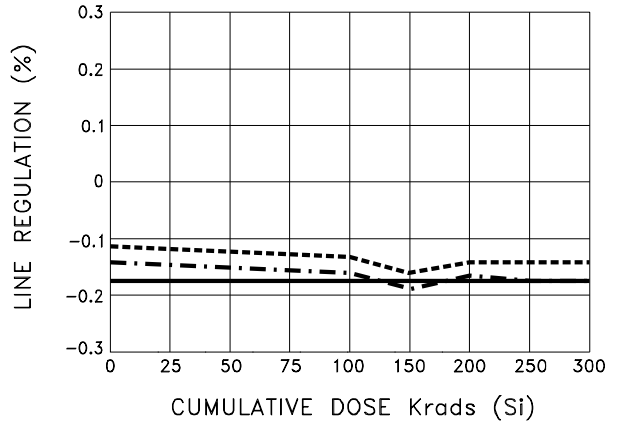

POSITIVE LOAD REGULATION

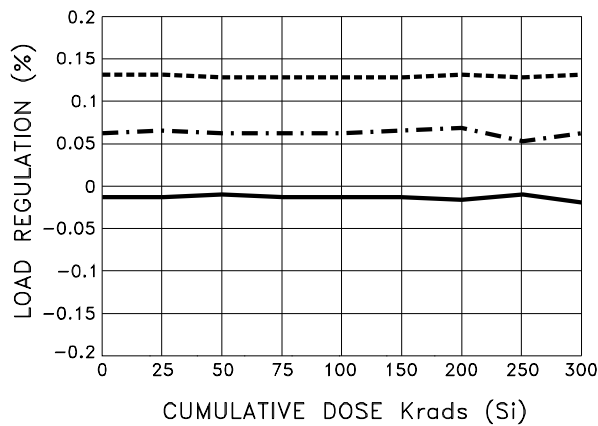

— CONTROL
 - - - BIASED
 - · - · UNBIASED

NOTE: All radiation performance curve test conditions are in accordance with the electrical specifications table (page 2).

TYPICAL PERFORMANCE CURVES CONT'D

NEGATIVE QUIESCENT CURRENT

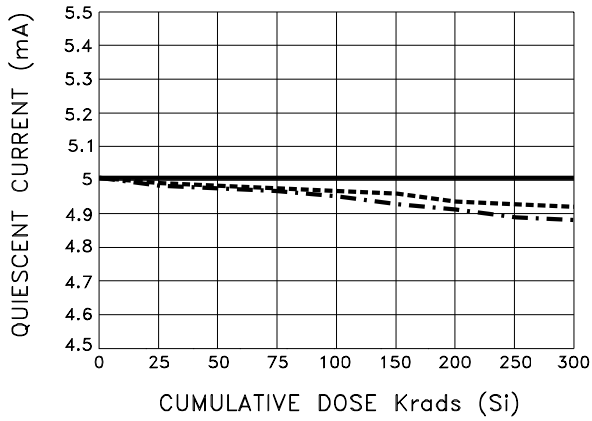

NEGATIVE OUTPUT VOLTAGE TOLERANCE

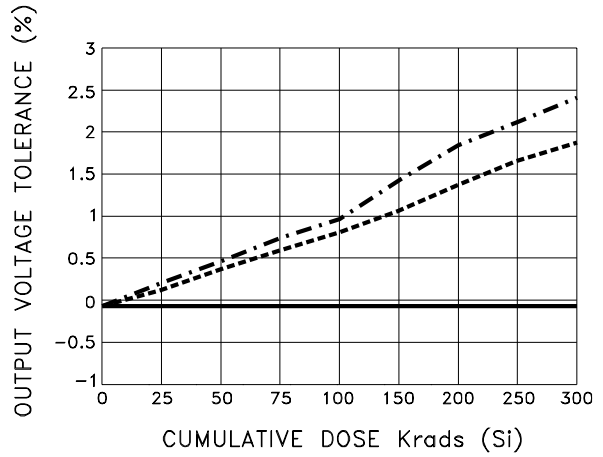

NEGATIVE DROPOUT VOLTAGE

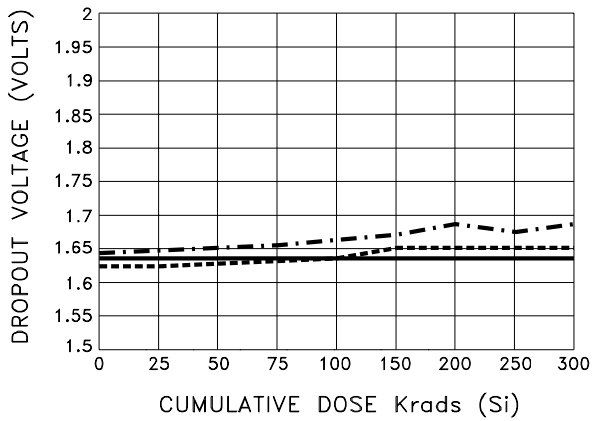

NEGATIVE LINE REGULATION

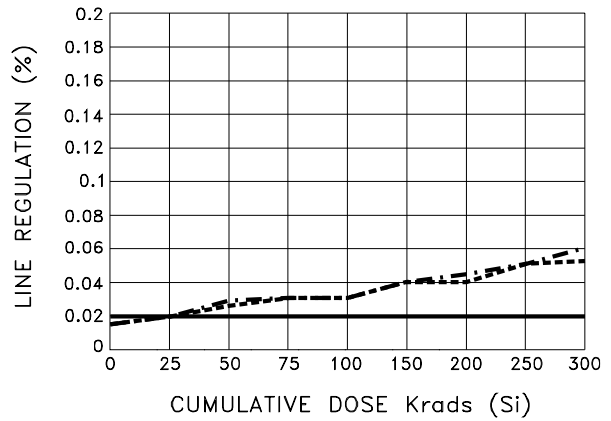

NEGATIVE LOAD REGULATION

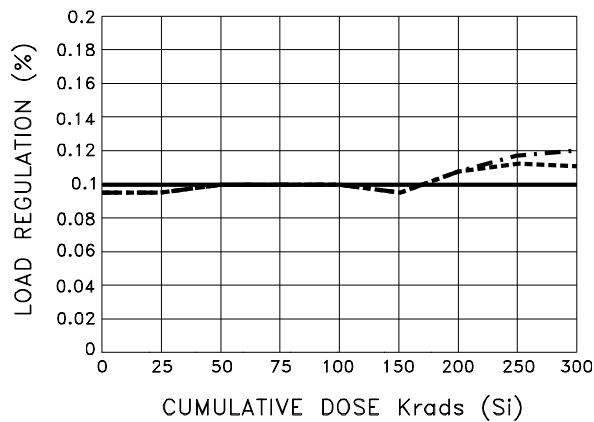

- CONTROL
- - - - BIASED
- · - · UNBIASED

NOTE: All radiation performance curve test conditions are in accordance with the electrical specifications table (page 2).

MECHANICAL SPECIFICATIONS

MSK591XRH

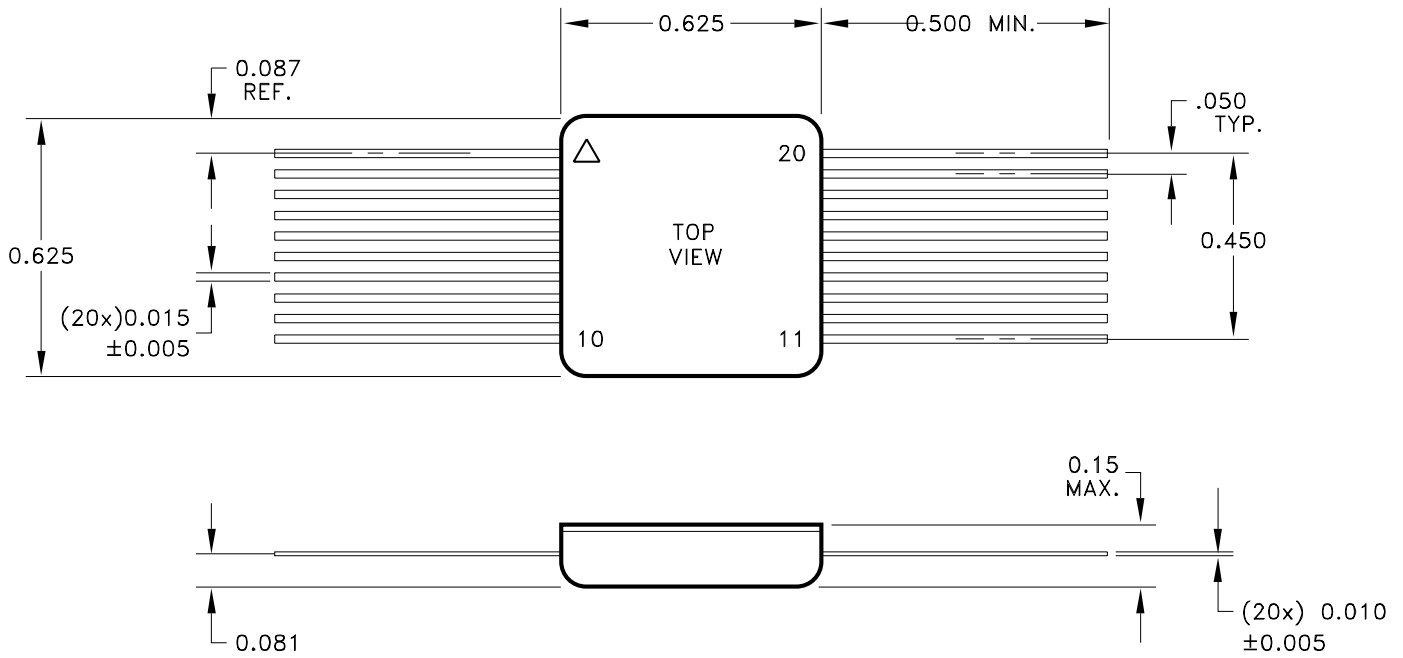

Weight = 4.3 Grams Typical

NOTE: ALL DIMENSIONS ARE ±0.010 INCHES UNLESS OTHERWISE LABELED.
ESD Triangle indicates pin 1.

ORDERING INFORMATION

Part Number	Screening Level
MSK591XRH	Industrial
MSK591XHRH	MIL-PRF-38534 CLASS H
MSK591XKRH	MIL-PRF-38534 CLASS K
MSK591XERH	EXTENDED RELIABILITY

X - Designates voltage selection (MSK 5911-5919)

MECHANICAL SPECIFICATIONS CONTINUED

MSK591XRHG

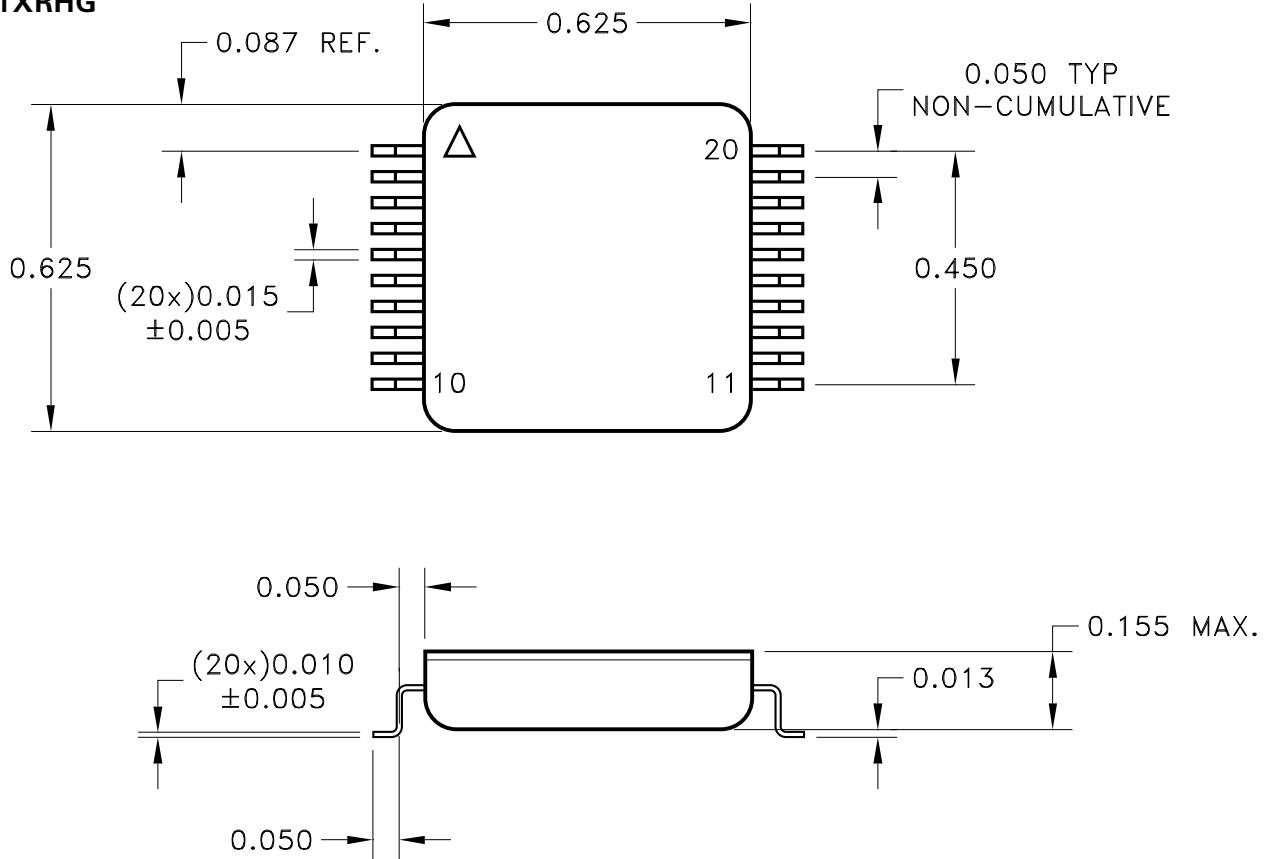

Weight = 4.2 Grams Typical

NOTE: ALL DIMENSIONS ARE ±0.010 INCHES UNLESS OTHERWISE LABELED.
ESD Triangle indicates pin 1.

ORDERING INFORMATION

Part Number	Screening Level
MSK591XRHG	Industrial
MSK591XHRHG	MIL-PRF-38534 CLASS H
MSK591XKRHG	MIL-PRF-38534 CLASS K
MSK591XERHG	EXTENDED RELIABILITY

X - Designates voltage selection (MSK 5911-5919)

M.S. Kennedy Corp.
4707 Dey Road, Liverpool, New York 13088
Phone (315) 701-6751
Fax (315) 701-6752
www.mskennedy.com

The information contained herein is believed to be accurate at the time of printing. MSK reserves the right to make changes to its products or specifications without notice, however and assumes no liability for the use of its products. Please visit our website for the most recent revision of this datasheet.

Contact MSK for MIL-PRF-38534 Class H, Class K and Appendix G (radiation) status.