

DIP 14 SERIES REED RELAYS

MSS2 ■ MSS7 ■ PRMA ■ DSS7 ■ PRME ■ MVS2 ■ MVS7



DESCRIPTION

CP Clare's epoxy molded DIP 14 Series offers a variety of contacts and schematics to meet the needs of a wide range of applications. It features the MVS2/MVS7 models designed for high reliability. The MSS2/7 DIPs are 1 form A relays equipped with the MYAD® all-position mounting switch. With switching up to 50 Watts and a 4000V isolation option, the DIP 14 Series is a relay package that allows for automatic insertion directly on PCBs as well as insertion into standard 14 pin DIP sockets.

FEATURES

- All position mercury contacts on some models
- Stable contact resistance over life
- 4000 Vac input-output isolation
- Bounce free operation
- High insulation resistance
- Switching speed of 300 Hz
- Long life > 1 billion operations
- Epoxy molded for automatic board processing

APPLICATIONS

- Automatic test equipment
- Process control
- Industrial
- Telecom
- Datacom
- High-end security systems
- Signaling
- Metering

APPROVALS

- UL approval (DSS7 & PRMA)
- BSI approval (DSS7 & MSS7)
- BS EN 60950 approval (MVS7)
- CSA approval (PRMA)
- FCC68 approval (MSS2 & MSS7)

RATINGS @ 25°C

Parameter	Min	Typ	Max	Unit
Switching Voltage				
PRMA/PRME/DSS7			200	Volts
PRMA Form C			100	Volts
MSS2/MSS7			500	Volts
MVS2/MVS7			1000	Volts
Switching Current				
PRMA/PRME/DSS7			0.5	Amps
PRMA Form C			0.25	Amps
MSS2/MSS7/MVS2/MVS7			2	Amps
Carry Current				
PRMA/PRME/DSS7			2	Amps
PRMA Form C			0.4	Amps
MSS2/MSS7			3	Amps
MVS2/MVS7			3	Amps
Switching Frequency				
PRMA/PRME/DSS7			500	Hz
PRMA Form C			50	Hz
MSS2/MSS7/MVS2/MVS7			200	Hz
Contact Resistance				
PRMA/PRME/DSS7			150	mΩ
PRMA Form C			200	mΩ
MSS2/MSS7/MVS2/MVS7			100	mΩ

(See detailed specifications for more information.)

SPECIFICATIONS

All parameters are at 25°C unless otherwise stated.
Operate voltage, release voltage, and coil resistance will change approximately 0.4%/°C as ambient temperature varies.

MSS2	MSS7	PRMA
Molded 8-pin	Molded 4-pin	Molded 8-pin
All position	All position	Form C
Wetted contacts	Wetted contacts	Dry Reed

Parameter	Conditions	Symbol	Min	Typ	Max	Min	Typ	Max	Min	Typ	Max	Units
Contact Ratings												
Switching Voltage	Max DC/PeakAC Resistive	V _L			500			500			100	Volts
Switching Current	Max DC/PeakAC Resistive	I _L			2			2			0.25	Amps
Carry Current	Max DC/PeakAC Resistive	I _c			3			3			0.4	Amps
Contact Rating	Max DC/PeakAC Resistive				50			50			3	Watts
Life Expectancy	Signal Level 1.0 V 10mA Rated Loads ¹			200			200			20		x10 ⁶ Ops
Static Contact Resistance	50mV, 10mA	CR		40	100		65	100			200	mΩ
Dynamic Contact Resistance	.5V, 50mA at 100 Hz, 1.5 msec	DCR		N/A			N/A			N/A		mΩ
Contact Material				Hg			Hg			Rh		
Hg Content				16			16			N/A		mgrams
Relay Specifications												
Insulation Resistance	Between all isolated pins at 100V, 25°C, 40% RH	IR	10 ⁸	10 ¹⁰		10 ⁸	10 ¹⁰		10 ⁹	10 ¹⁰		Ω
Capacitance	Across Open Contacts			1.5	2		1.2	2		2.5	3	pF
	Open Contact to Coil			3	4		3	4		3	3	pF
Dielectric Strength	Between Contacts		1400			2000			250			VDC/Peak AC
	Contacts to Coil	I/O	1400			5600			1400			VDC/Peak AC
Operate Time, including bounce (PRMA only)	At Nominal Coil Voltage 10Hz Square Wave	T _{OP}		1.2	1.75		1.2	1.75		1.5	2	ms
Release Time	Zener-Diode Suppression	T _{REL}		1	1.50		1	1.50		1.5	3	ms
Environmental Ratings												
Storage Temperature		T _A	-40		+105	-40		+105	-40		+105	°C
Operating Temperature		T _O	-38		+75	-38		+75	-40		+80	°C
Soldering Temperature	Applied to pins, 5 sec. max.			260			260			260		°C
Vibration Resistance (Survival)	10 Hz - 500 Hz (5 Hz - 500 Hz for PRMA)	G			10			10			10	Gs
Shock Resistance (Survival)	11±1ms, 1/2 Sine Wave	S			30			30			50	Gs
Weight				2.3			2.3			1.5		grams

¹ Refer to life graphs

DIP 14 SERIES REED RELAYS

MSS2 ■ MSS7 ■ PRMA ■ DSS7 ■ PRME ■ MVS2 ■ MVS7

COIL SPECIFICATIONS

Part #	Contact Form	Coil Voltage			Coil Resistance			Operate Voltage			Release Voltage			Nominal Input Power		
		Min	Typ	Max	Min	Typ	Max	Min	Typ	Max	Min	Typ	Max	Min	Typ	Max
Units		Volts			Ω			Volts			Volts			mW		
Conditions					+/- 10% (25°C)			Must operate by (25°C)			Must release by (25°C)					
MSS2 1A05	1 Form A	5	11	11	126	140	154	0.5		3.75	0.5		3.75			179
MSS2 1A12	1 Form A	12	21	21	450	500	550	1		9	1		9			288
MSS2 1A24	1 Form A	24	44	44	1935	2150	2365	2		18	2		18			268
MSS7 1A05	1 Form A	5	11	11	126	140	154	0.5		3.75	0.5		3.75			179
MSS7 1A12	1 Form A	12	21	21	450	500	550	1		9	1		9			288
MSS7 1A24	1 Form A	24	43	43	1935	2150	2365	2		18	2		18			268
PRMA 1A05	1 Form A	5	21	21	450	500	550	0.8		3.75	0.8		3.75			50
PRMA 1A12	1 Form A	12	30	30	900	1000	1100	1		9	1		9			144
PRMA 1A24	1 Form A	24	44	44	1935	2150	2365	2		18	2		18			268
PRMA 1B05	1 Form B	5	6	6	450	500	550	0.8		3.75	0.8		3.75			50
PRMA 1B12	1 Form B	12	14.5	14.5	900	1000	1100	1		9	1		9			144
PRMA 1B24	1 Form B	24	29	29	1935	2150	2365	2		18	2		18			268
PRMA 1C05	1 Form C	5	12	12	180	200	220	0.8		3.75	0.8		3.75			125
PRMA 1C12	1 Form C	12	18	18	450	500	550	1		9	1		9			288
PRMA 1C24	1 Form C	24	32	32	1935	2150	2365	2		18	2		18			268
PRMA 2A05	2 Form A	5	11	11	126	140	154	0.8		3.75	0.8		3.75			179
PRMA 2A12	2 Form A	12	21	21	450	500	550	1		9	1		9			288
PRMA 2A24	2 Form A	24	44	44	1935	2150	2365	2		18	2		18			268
PRMA 10037	1 Form A	5	15	15	342	380	418	0.8		3.75	0.8		3.75			66
PRMA 10038	1 Form A	12	19	19	477	530	583	1		9	1		9			272
PRMA 10039	1 Form A	24	32	32	1800	2000	2200	2		18	2		18			288
DSS7 1A05	1 Form A	5	21	21	450	500	550	0.8		3.75	0.8		3.75			50
DSS7 1A12	1 Form A	12	30	30	900	1000	1100	1		9	1		9			144
DSS7 1A24	1 Form A	24	44	44	1935	2150	2365	2		18	2		18			268
PRME 25005	1 Form A	5	19	19	450	500	550	0.8		3.8	0.8		3.8			50
PRME 15005	1 Form A	5	15	15	342	380	418	1		3.5	1		3.5			66
PRME 15002	1 Form A	12	19	19	477	530	583	1		8	1		8			272
PRME 15003	1 Form A	24	32	32	1800	2000	2200	2		16	2		16			288
MVS2 1A05(A,B)	1 Form A	5	7	7	94.5	105	116	0.5		3.75	0.5		3.75			238
MVS2 1A12(A,B)	1 Form A	12	15	15	450	500	550	1		9	1		9			288
MVS2 1A24(A,B)	1 Form A	24	30	30	1935	2150	2365	2		18	2		18			268
MVS7 1A05(S)	1 Form A	5	7	7	94.5	105	116	0.5		3.75	0.5		3.75			238
MVS7 1A12(S)	1 Form A	12	15	15	450	500	550	1		9	1		9			288
MVS7 1A24(S)	1 Form A	24	30	30	1935	2150	2365	2		18	2		18			268

PERFORMANCE GRAPHS

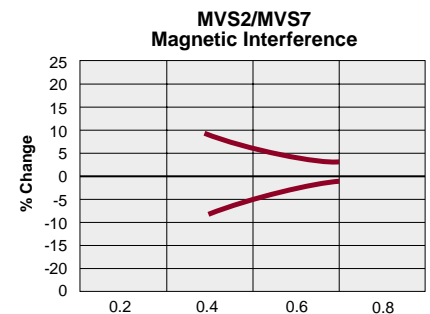
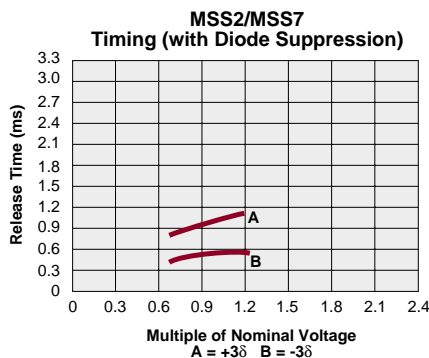
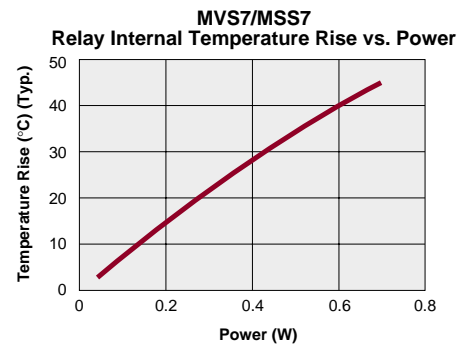
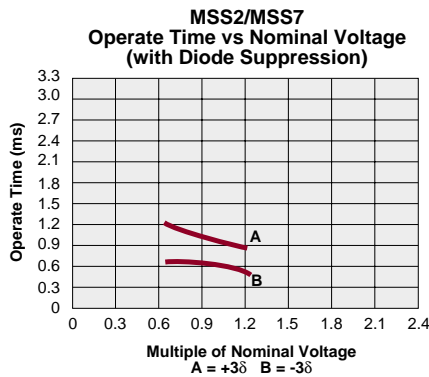
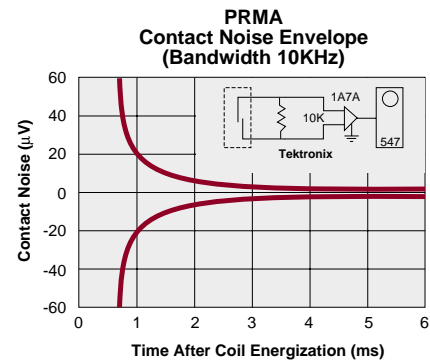
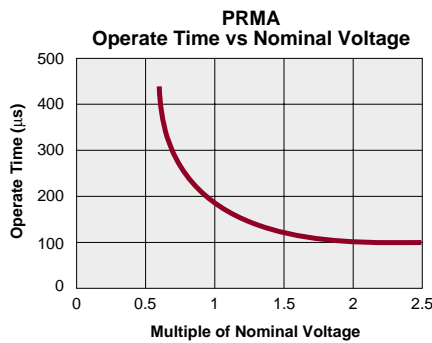
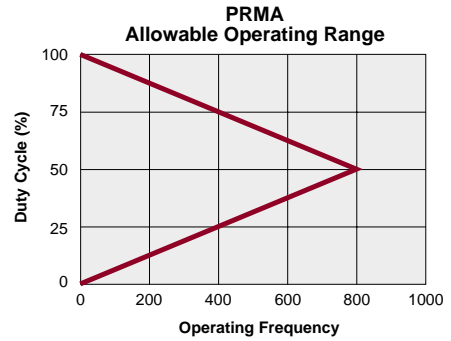
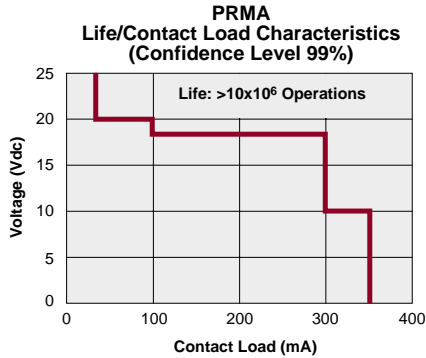

X = Distance (in.) between centers of adjacent relays.
(For distance between relay bodies, subtract .400)

DIP 14 SERIES REED RELAYS

MSS2 ■ MSS7 ■ PRMA ■ DSS7 ■ PRME ■ MVS2 ■ MVS7

MECHANICAL DIMENSIONS

mm
(inches)

MVS2/MSS2/PRMA

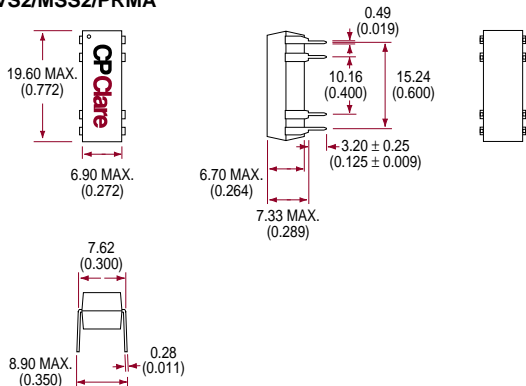

PRMA 1A

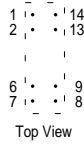

Top View

Options:
Diode - pin #2 is positive
Electrostatic shield - pin 9

PRMA 1B

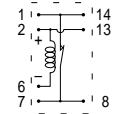

Top View

Options:
Diode - pin #2 is positive
Electrostatic shield - pin 9

PRMA 1C

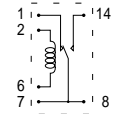

Top View

Options:
Diode - pin #2 is positive
Electrostatic shield - pin 9

PRMA 2A

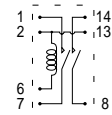

Top View

Options:
Diode - pin #2 is positive
Electrostatic shield - pin 9

PRMA 10037/10038/10039

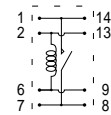

Top View

MVS2/MSS2

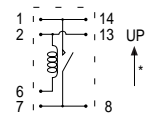

Top View

* MVS2 only must be mounted vertically with pin #1 UP.

PRME

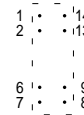
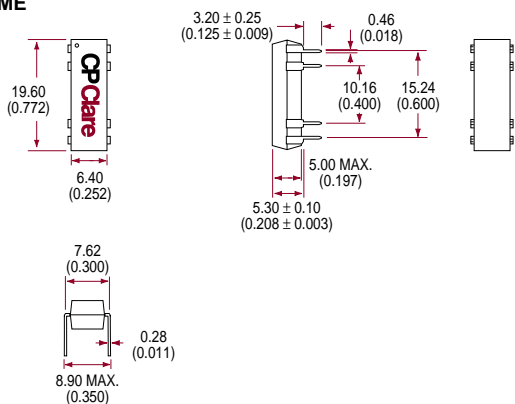

Top View

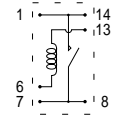

Top View

Options:
Diode - pin #13 is positive
Electrostatic shield - pin 9

DSS7/MSS7

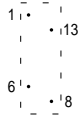
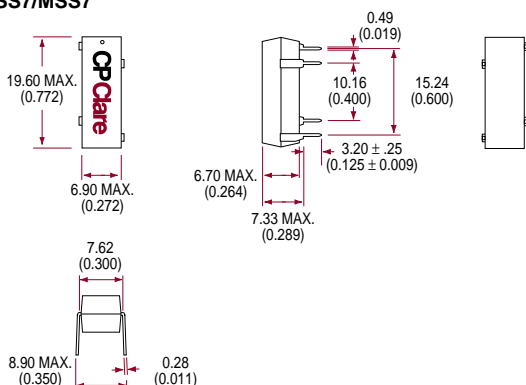

Top View

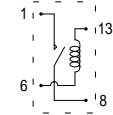

Top View

MVS7 must be mounted vertically. Pin #1 is up.

ORDERING INFORMATION

A complete part number is represented by the digits below. For example, the MVS21A05 is a model 2 MVS relay with a 1 Form A contact form, a nominal voltage of 5V and no extra options.

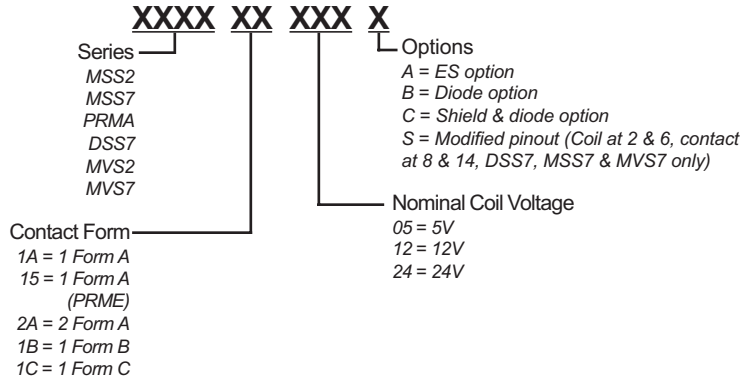

Ordering Information Special Schematics

PRME 25005
PRME 15005
PRME 15002
PRME 15003

PRMA 10037
PRMA 10038
PRMA 10039

These represent full part numbers.