

# INNOLUX DISPLAY CORPORATION

## MT170EN01 V.7 LCD MODULE SPECIFICATION

- ( ) Preliminary Specification  
 (✓) Final Specification

Customer	Checked & Approved by

Approved by	Checked by			Prepared by
MKT	QRA	PD	TD	MKT
朱清華 12/29	葉佳元 12/30	張永宜 12/29	楊秋蓮 12/30/05	顏亭成 12/29

Date: 2005, 12, 29

### Innolux Display Corporation,

No.160 Kesyue Rd., Chu-Nan Site, Hsinchu Science Park,

Chu-Nan 350, Miao-Li County, Taiwan

Tel: 886-37-586000

Fax: 886-37-586060

Document Number: MT170EN01 V.7-DR2-04

InnoLux copyright  
All rights reserved,  
Copying forbidden.

### Record of Revision

Version	Revise Date	Page	Content
01	2005-09-19		First edition to all

<b>Contents:</b>	
<b>A. General Specification</b>	
<b>B. Electrical Specifications</b>	
1. Pin assignment	
2. Absolute maximum ratings	
3. Electrical characteristics	
a. Typical operating conditions	
b. Display color v.s. input data signals	
c. Input signal timing	
d. Display position	
e. Backlight driving conditions	
<b>C. Optical specifications</b>	
<b>D. Reliability test items</b>	
<b>E. Safety</b>	
<b>F. Display quality</b>	
<b>G. Handling precaution</b>	
<b>H. Label</b>	
<b>I. Packing form</b>	
<b>J. Mechanical drawings</b>	
<b>Appendix</b>	

**A. General specification**

NO.	Item	Specification	Remark
1	Display resolution (pixel)	1280(H) X 1024(V), SXGA resolution	
2	Active area (mm)	337.9(H) X 270.3(V)	
3	Screen size (inch)	17 inches diagonal	
4	Pixel pitch (mm)	0.264(H) X 0.264(V)	
5	Color configuration	R, G, B vertical stripe	
6	Overall dimension (mm)	358.5(W)x296.5(H)x17.5 (D) Max	
7	Weight (g)	2000 max	
8	Surface treatment	Anti-glare, Haze = 25%, Hard coating (3H)	
9	Input color signal	8 bit LVDS	
10	Color saturation	72% NTSC	
11	Display colors	16.2M colors (6 bit with FRC)	
12	Optimum viewing direction	6 o'clock	
13	Backlight	4 CCFL, top & bottom edge side	
14	TCO'03 and RoHS	TCO'03 and RoHS compliance	

**B. Electrical specifications**

## 1.Pin assignment

**Connector** JAE FI-X30SSL-HF or equivalent

Pin No	Symbol	Description
1	RxO0-	LVDS Differential data input Channel 0(-)
2	RxO0+	LVDS Differential data input Channel 0(+)
3	RxO1-	LVDS Differential data input Channel 1(-)
4	RxO1+	LVDS Differential data input Channel 1(+)
5	RxO2-	LVDS Differential data input Channel 2(-)
6	RxO2+	LVDS Differential data input Channel 2(+)
7	GND	Ground
8	RxOC-	LVDS Differential Clock input (-)
9	RxOC+	LVDS Differential Clock input (+)
10	RxO3-	LVDS Differential data input Channel 3(-)
11	RxO3+	LVDS Differential data input Channel 3(+)
12	RxE0-	LVDS Differential data input Channel 0(-)
13	RxE0+	LVDS Differential data input Channel 0(+)
14	GND	Ground
15	RxE1-	LVDS Differential data input Channel 1(-)
16	RxE1+	LVDS Differential data input Channel 1(+)
17	GND	Ground
18	RxE2-	LVDS Differential data input Channel 2(-)
19	RxE2+	LVDS Differential data input Channel 2(+)
20	RxEC-	LVDS Differential Clock input (-)
21	RxEC+	LVDS Differential Clock input (+)
22	RxE3-	LVDS Differential data input Channel 3(-)
23	RxE3+	LVDS Differential data input Channel 3(+)
24	GND	Ground
25	GND	Ground
26	GND	Ground or Open
27	GND	Ground
28	VCC	Power supply (+5.0V)
29	VCC	Power supply (+5.0V)
30	VCC	Power supply (+5.0V)

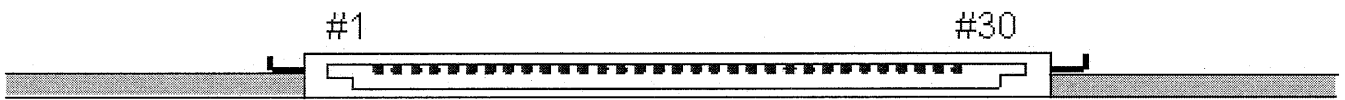
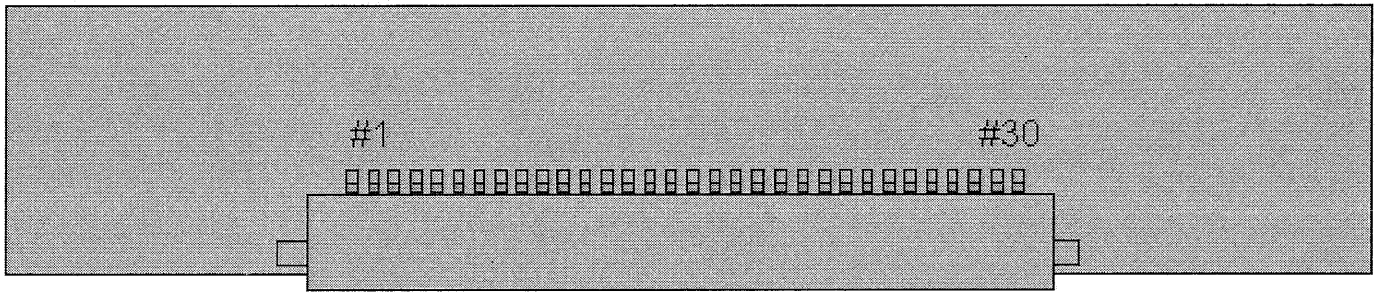

Rear view of LCM

2. Absolute maximum ratings

Parameter	Symbol	Values		Unit	Remark
		Min.	Max.		
Power voltage	$V_{CC}$	- 0.3	7.0	V	At 25°C
Input signal voltage	$V_{LH}$	- 0.3	3.6	V	At 25°C
Operating temperature	$T_{OP}$	0	50	°C	Note 1
Storage temperature	$T_{ST}$	- 25	60	°C	Note 2
CCFL Current	ICFL	2	8	[mA] rms	

Note 1: The relative humidity must not exceed 90% non-condensing at temperatures of 40°C or less. At temperatures greater than 40°C, the wet bulb temperature must not exceed 39°C.

Note 2: The unit should not be exposed to corrosive chemicals.

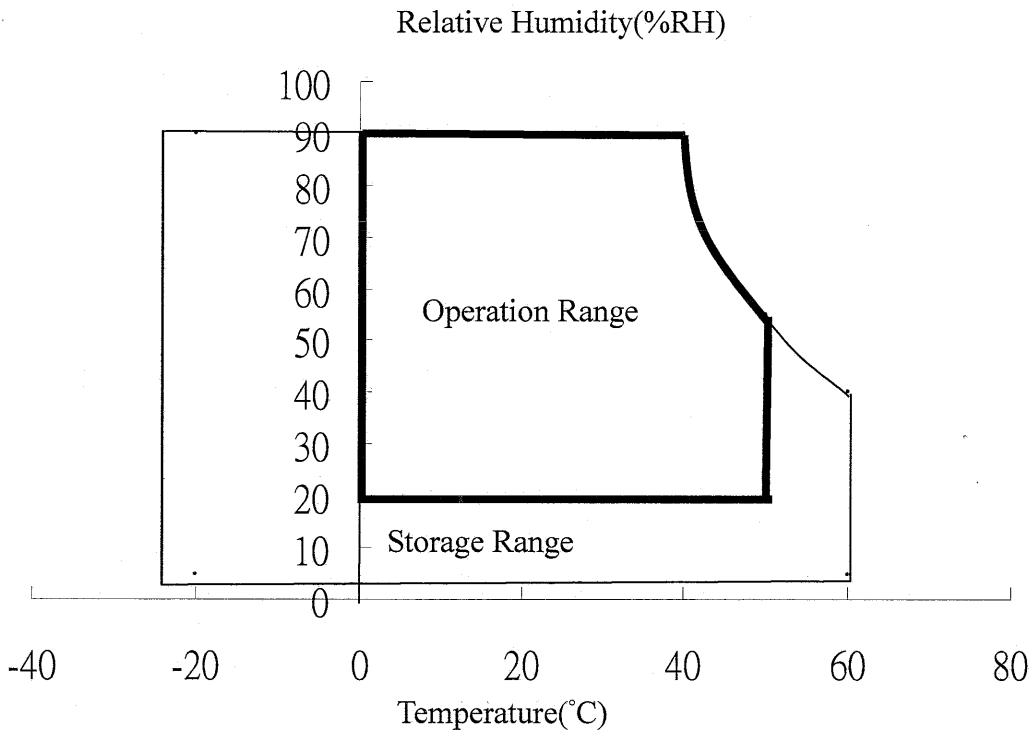

## 3. Electrical characteristics

## a. Typical operating conditions

Item	Symbol	Min.	Typ.	Max.	Unit	Remark	
Input Voltage	$V_{cc}$	4.5	5.0	5.5	V		
Permissive Power Input Ripple	$V_{RF}$	0.1	-	-	V	Note 1	
Input Current	$I_{cc}$	-	0.65	0.85	A	Note 2	
Differential Impedance	$Z_m$	90	100	110	ohm		
Rush Current	$I_{Rush}$	-	2.0	3.0	A	Note 3	
Logic Input Voltage LVDS: IN+, IN-	Common Mode Voltage	VCM	1.125	1.25	1.375	V	
	Differential Input Voltage	VID	250	350	450	mV	
	Threshold Voltage (High)	VTH	-	-	100	mV	Note 4
	Threshold Voltage (Low)	VTL	-100			mV	Note 4

Note 1: Power input ripple should not exceed min. value.

Note 2: The specified current is under the  $V_{cc}=5V$ ,  $25\text{ }^{\circ}C$ ,  $fV=60Hz$  (frame frequency) condition whereas mosaic pattern (black & white [8\*6] ) is displayed.

White : 255 Gray

Black : 0Gray

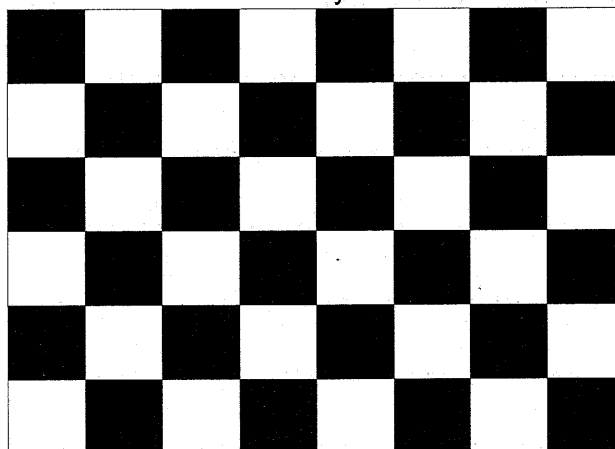

mosaic pattern (black & white [8\*6] )



Note 3 : test condition :

- (1)  $V_{cc} = 5\text{ V}$ ,  $V_{cc}$  rising time =  $470\ \mu\text{s} \pm 10\%$
- (2) Pattern: Mosaic pattern

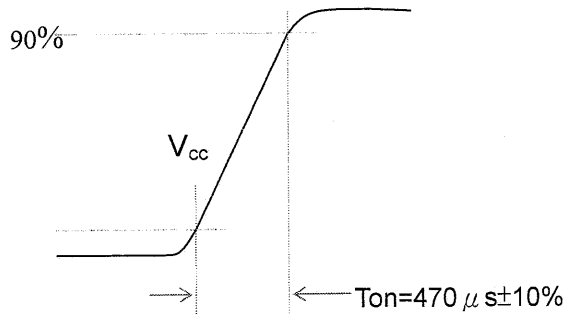

(3) Test circuit

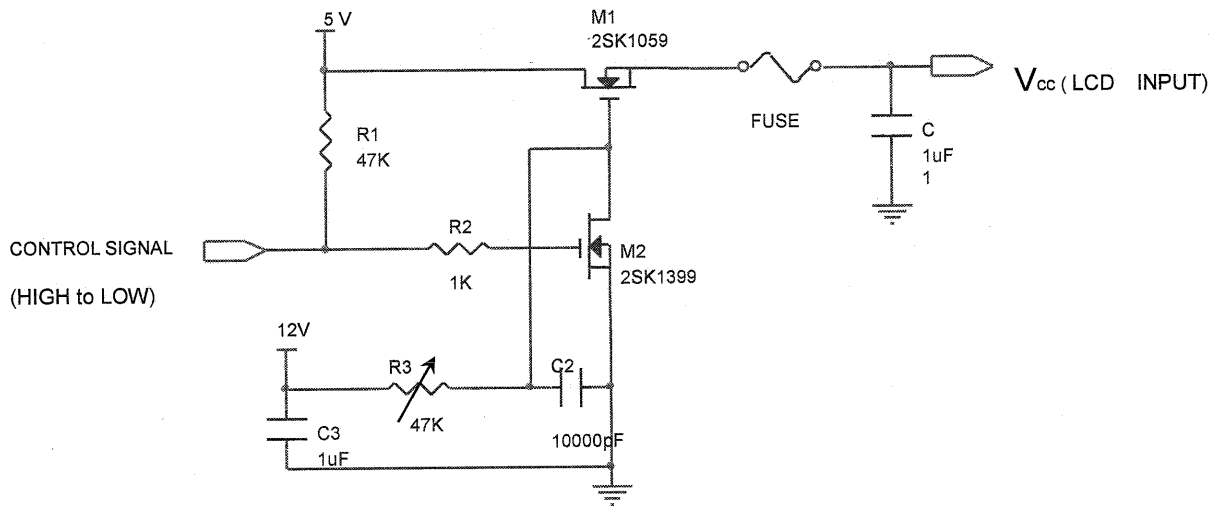

Note 4 : LVDS signal definition

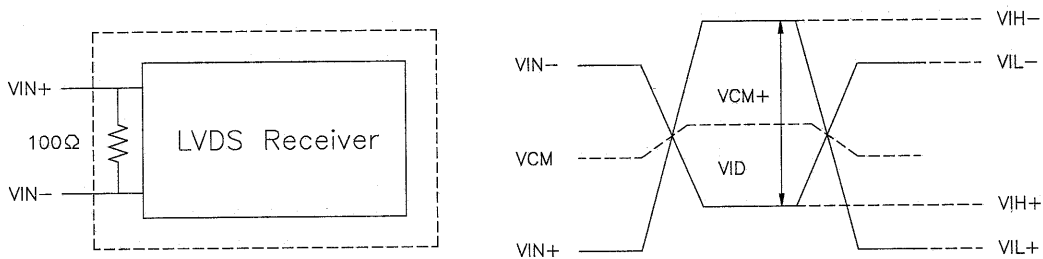

$$VID = VIN_+ - VIN_- ,$$

$$\Delta VCM = | VCM_+ - VCM_- | ,$$

$$\Delta VID = | VID_+ - VID_- | ,$$

$$VID_+ = | VIH_- - VIH_- | ,$$

$$VID_- = | VIL_+ - VIL_- | ,$$

$$VCM = (VIN_+ + VIN_-)/2 ,$$

$$VCM_+ = (VIH_+ + VIH_-)/2 ,$$

$$VCM_- = (VIL_+ + VIL_-)/2 ,$$

$VIN_+$  = Positive differential DATA & CLK Input

$VIN_-$  = Negative differential DATA & CLK Input

Note 5 : Power on sequence for LCD V<sub>cc</sub>

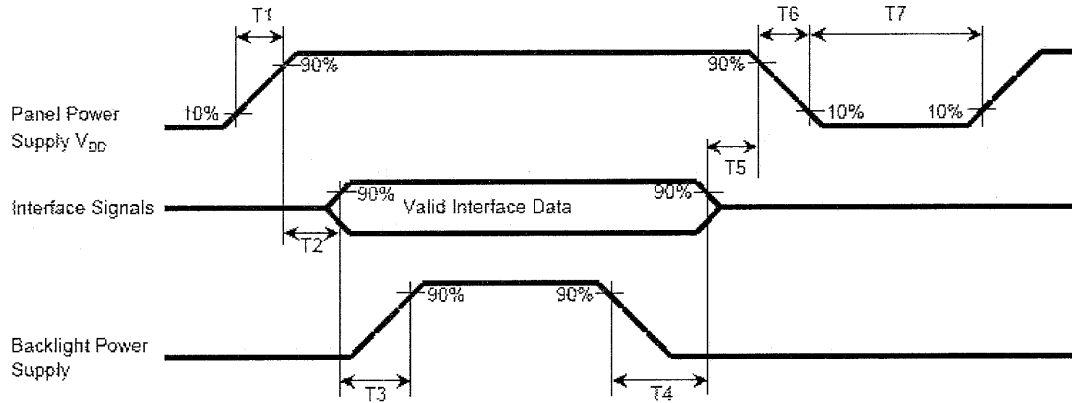

Parameter	Value			Unit
	Min	Typ	Max	
T1	0.1	--	10	ms
T2	0	--	10	ms
T3	200	250	--	ms
T4	100	250	--	ms
T5	0	20	50	ms
T6	0.1	--	15	ms
T7	1000	--	--	ms

b. Display color v.s. input data signals

The brightness of each primary color (red, green and blue) is based on the 8-bit gray scale data input for the color; the higher the binary input, the brighter the color. The table below provides a reference for color versus data input.

Color	Input color data																							
	Red								Green								Blue							
	MSB				LSB				MSB				LSB				MSB				LSB			
	R7	R6	R5	R4	R3	R2	R1	R0	G7	G6	G5	G4	G3	G2	G1	G0	B7	B6	B5	B4	B3	B2	B1	B0
Basic colors	Black	0	0	0	0	0	0	0	0	0	0	0	0	0	0	0	0	0	0	0	0	0	0	0
	Red(255)	1	1	1	1	1	1	1	1	0	0	0	0	0	0	0	0	0	0	0	0	0	0	0
	Green(255)	0	0	0	0	0	0	0	0	1	1	1	1	1	1	1	1	0	0	0	0	0	0	0
	Blue(255)	0	0	0	0	0	0	0	0	0	0	0	0	0	0	0	0	1	1	1	1	1	1	1
	Cyan	0	0	0	0	0	0	0	0	1	1	1	1	1	1	1	1	1	1	1	1	1	1	1
	Magenta	1	1	1	1	1	1	1	1	0	0	0	0	0	0	0	0	1	1	1	1	1	1	1
	Yellow	1	1	1	1	1	1	1	1	1	1	1	1	1	1	1	1	0	0	0	0	0	0	0
	White	1	1	1	1	1	1	1	1	1	1	1	1	1	1	1	1	1	1	1	1	1	1	1
Red	Red(000) dark	0	0	0	0	0	0	0	0	0	0	0	0	0	0	0	0	0	0	0	0	0	0	
	Red(001)	0	0	0	0	0	0	0	1	0	0	0	0	0	0	0	0	0	0	0	0	0	0	
	Red(002)	0	0	0	0	0	0	1	0	0	0	0	0	0	0	0	0	0	0	0	0	0	0	
	:	:	:	:	:	:	:	:	:	:	:	:	:	:	:	:	:	:	:	:	:	:	:	
	Red(253)	1	1	1	1	1	1	0	1	0	0	0	0	0	0	0	0	0	0	0	0	0	0	
	Red(254)	1	1	1	1	1	1	1	0	0	0	0	0	0	0	0	0	0	0	0	0	0	0	
	Red(255) bright	1	1	1	1	1	1	1	1	0	0	0	0	0	0	0	0	0	0	0	0	0	0	
Green	Green(000)dark	0	0	0	0	0	0	0	0	0	0	0	0	0	0	0	0	0	0	0	0	0	0	
	Green(001)	0	0	0	0	0	0	0	0	0	0	0	0	0	0	0	1	0	0	0	0	0	0	
	Green(002)	0	0	0	0	0	0	0	0	0	0	0	0	0	0	1	0	0	0	0	0	0	0	
	:	:	:	:	:	:	:	:	:	:	:	:	:	:	:	:	:	:	:	:	:	:	:	
	Green(253)	0	0	0	0	0	0	0	0	1	1	1	1	1	1	0	1	0	0	0	0	0	0	
	Green(254)	0	0	0	0	0	0	0	0	1	1	1	1	1	1	1	0	0	0	0	0	0	0	
	Green(255)bright	0	0	0	0	0	0	0	0	1	1	1	1	1	1	1	1	0	0	0	0	0	0	
Blue	Blue(000) dark	0	0	0	0	0	0	0	0	0	0	0	0	0	0	0	0	0	0	0	0	0	0	
	Blue(001)	0	0	0	0	0	0	0	0	0	0	0	0	0	0	0	0	0	0	0	0	0	1	
	Blue(002)	0	0	0	0	0	0	0	0	0	0	0	0	0	0	0	0	0	0	0	0	0	1	
	:	:	:	:	:	:	:	:	:	:	:	:	:	:	:	:	:	:	:	:	:	:	:	
	Blue(253)	0	0	0	0	0	0	0	0	0	0	0	0	0	0	0	0	1	1	1	1	1	0	
	Blue(254)	0	0	0	0	0	0	0	0	0	0	0	0	0	0	0	0	1	1	1	1	1	1	
	Blue(255) bright	0	0	0	0	0	0	0	0	0	0	0	0	0	0	0	0	1	1	1	1	1	1	

c. Input signal timing

Support Input Timing Table

	Item	Description	Min.	Typ.	Max.	Unit
Clock	Dclk	period	14.71	18.52	22.22	nS
		frequency	45	54	68	MHz
Vertical	$T_{V\_TOTAL}$	V total line number	1044	1066	1300	$T_{H\_TOTAL}$
	$T_{V\_DATA}$	Data duration	—	1024	—	$T_{H\_TOTAL}$
	$T_{VB}$	V-blank	20	42		$T_{H\_TOTAL}$
	$f_V$	frequency	50	60	75	Hz
Horizontal	$T_{H\_TOTAL}$	H total pixel number	710	844	980	DCIk
	$T_{H\_DATA}$	Data duration	—	640	—	DCIk
	$T_{HB}$	H-blank	70	204		DCIk

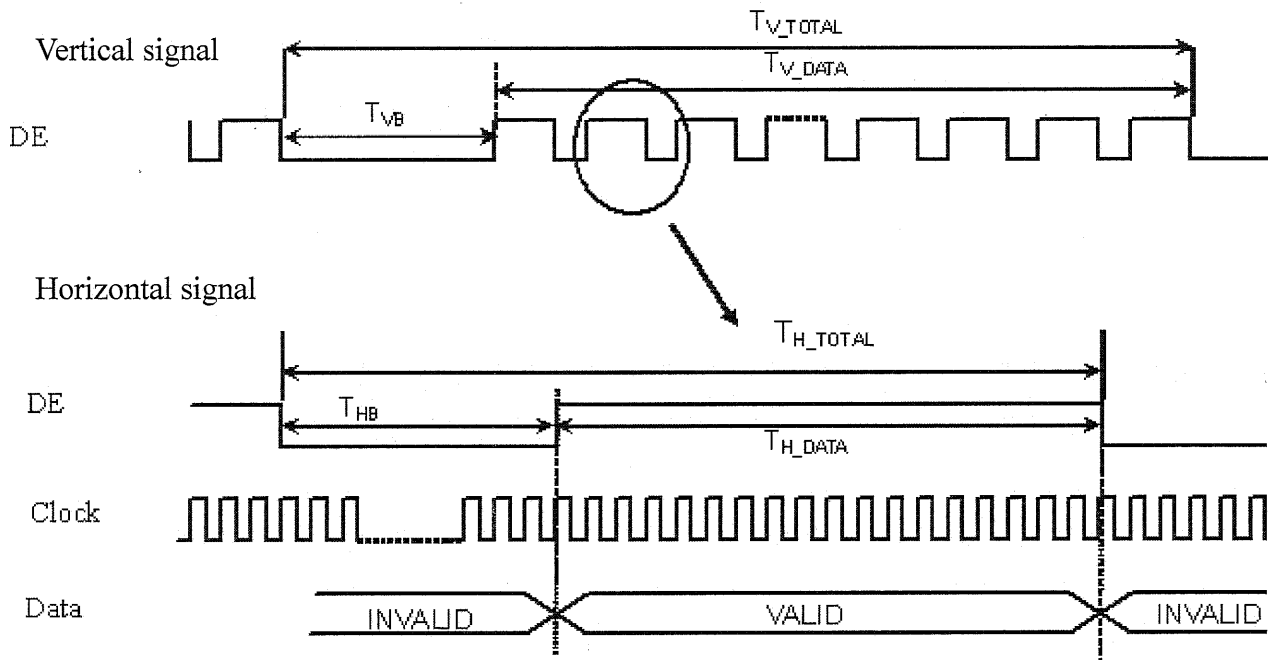

Note : DE is reference signal, DE means the display data valid.

d. Display Position

ALL RIGHTS STRICTLY RESERVED. ANY PORTION OF THIS PRPER SHALL NOT BE REPRODUCED, COPIED, OR TRANSFORMED TO ANY OTHER FORMS WITHOUT PERMISSION FROM INNOLUX DISPLAY CORPORATION.

D(1, 1)	D(2, 1)	.....	D(640, 1)	.....	D(1279, 1)	D(1280, 1)
D(1, 2)	D(2, 2)	.....	D(640, 2)	.....	D(1279, 2)	D(1280, 2)
⋮		.....	⋮	.....	⋮	⋮
D(1, 512)	D(2, 512)	.....	D(640, 512)	.....	D(1279, 512)	D(1280, 512)
⋮		.....	⋮	.....	⋮	⋮
D(1, 1023)	D(2, 1023)	.....	D(640, 1023)	.....	D(1279, 1023)	D(1280, 1023)
D(1, 1024)	D(2, 1024)	.....	D(640, 1024)	.....	D(1279, 1024)	D(1280, 1024)

e. Backlight driving conditions

Parameter	Symbol	Min.	Typ.	Max.	Unit	Remark	Remark
Lamp voltage	VL		610	700	Vrms		
Lamp operation current	IL	2	7	8	mArms		Note 1
Lamp starting voltage	VLstart	1500			Vrms	T = 25 °C	Note 2,3,4,5
		1750				T = 0 °C	Note 2,3,4,5
Frequency	F	40	50	80	KHZ		Note 5
Lamp life time		50000			Hr		Note 6

Note 1 :

The degrees of unbalance: less than 10%

The ratio of wave height: less than  $\sqrt{2} \pm 10\%$

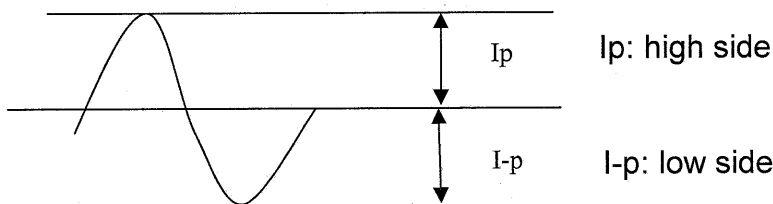

The degrees of umbalance =  $|Ip-I-p| / Irms * 100(\%)$

The ratio of wave height =  $Ip(or I-p) / Irms$

Lamp should be completely turned on.

Note 2:

Test equipment: AS-114B, Output Capacitor =18pF, f=57KHz

Note 3:

The voltage shown above should be applied to the lamp for more than 1 second after startup. Otherwise, the lamp may not be turned on normally.

Note 4:

Inverter should provide more than min. value, and then lamp could be completely turned on

Note 5:

Lamp frequency may produce interference with horizontal synchronous frequency and this

ALL RIGHTS STRICTLY RESERVED. ANY PORTION OF THIS PRPER SHALL NOT BE REPRODUCED, COPIED, OR TRANSFORMED TO ANY OTHER FORMS WITHOUT PERMISSION FROM INNOLUX DISPLAY CORPORATION.

may cause line flow on the display. Therefore lamp frequency shall be detached from the horizontal synchronous frequency and its harmonics as far as possible in order to avoid interference.

Note 6:

Lamp life definition:

The brightness of lamp becomes 50% of the initial brightness or not normal lighting.

Backlight connector : JST BHSR - 02VS-1

Pin no.	Symbol	Function	Remark
1	VIH	Lamp high voltage input	Cable color: Pink
2	VIL	Lamp low voltage input	Cable color: White

**C. Optical specifications**

Item	Symbol	Condition	Specification			Unit	Remark
			Min.	Typ.	Max.		
Response time	Tr	$\theta = 0^\circ$		2	4	ms	Note 4
	Tf			6	12		
	Tr+Tf			8	16		
Contrast ratio	CR	$\theta = 0^\circ$	500	700			Note 3,5
Viewing angle	Top	$CR \geq 10$	65	75		deg	Note 3,5,7
		$CR \geq 5$	75	85			
	Bottom	$CR \geq 10$	50	60			
		$CR \geq 5$	60	70			
	Left	$CR \geq 10$	65	75			
		$CR \geq 5$	75	85			
	Right	$CR \geq 10$	65	75			
		$CR \geq 5$	75	85			
Brightness (Center)	$Y_L$		250	300		nit	Note 3,6
Color chromaticity(CIE)	$W_x$	$\theta = 0^\circ$	-0.03	0.313	+0.03		Note 3
	$W_y$			0.329			
	$R_x$			0.640			
	$R_y$			0.349			
	$G_x$			0.284			
	$G_y$			0.617			
	$B_x$			0.142			
	$B_y$			0.067			
White uniformity (13)	$\delta_w$		0.75	0.8			Note 3,8
Cross talk	Ct				2%		Note 9

Note 1: Ambient temperature = 25°C.

Note 2: To be measured in dark room after backlight warm up 30 minutes.

Note 3: To be measured with a viewing cone of 2° by Topcon luminance meter BM-5A.

Note 4: Definition of response time:

The output signals of BM-7 are measured when the input signals are changed from "Black" to "White" (falling time) and from "White" to "Black" (rising time), respectively. The response time interval between the 10% and 90% of amplitudes. Refer to figure as below.

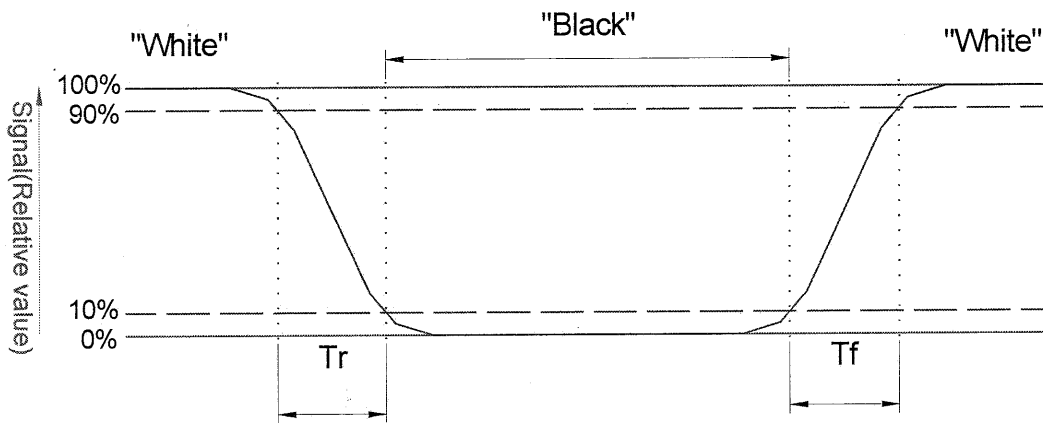

Note 5. Definition of contrast ratio:

Contrast ratio is calculated with the following formula.

$$\text{Contrast ratio (CR)} = \frac{\text{Brightness on the "white" state}}{\text{Brightness on the "black" state}}$$

Note 6: Driving conditions for CCFL:  $I_L = 7.0 \text{ mA}$ , 50 KHz Frequency.

Note 7: Definition of viewing angle

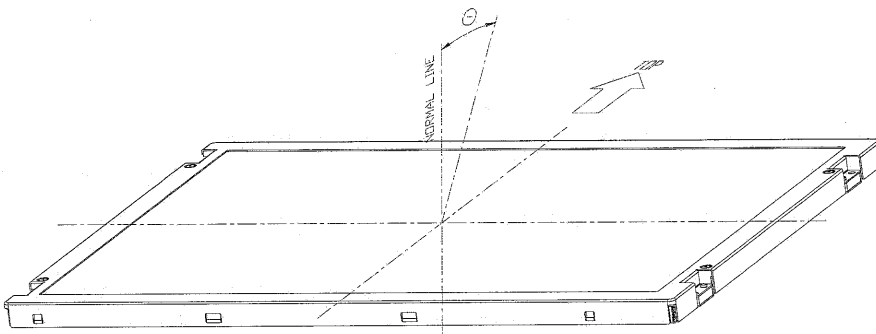

Note 8: Definition white uniformity:

Luminance are measured at the following thirteen points (1~13).

$$\delta_w = \frac{\text{Minimum Brightness of thirteen points}}{\text{Maximum Brightness of thirteen points}}$$



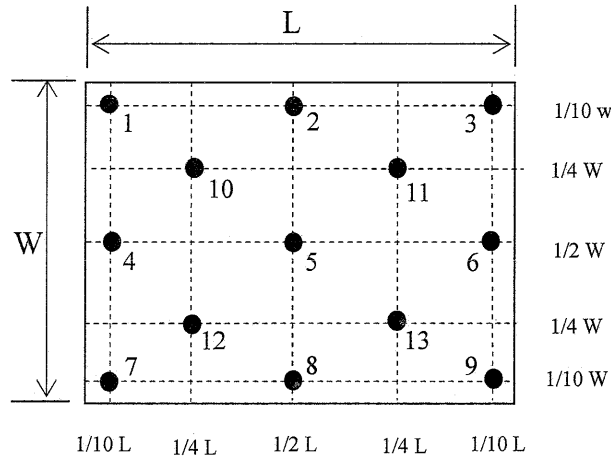

Note 9:

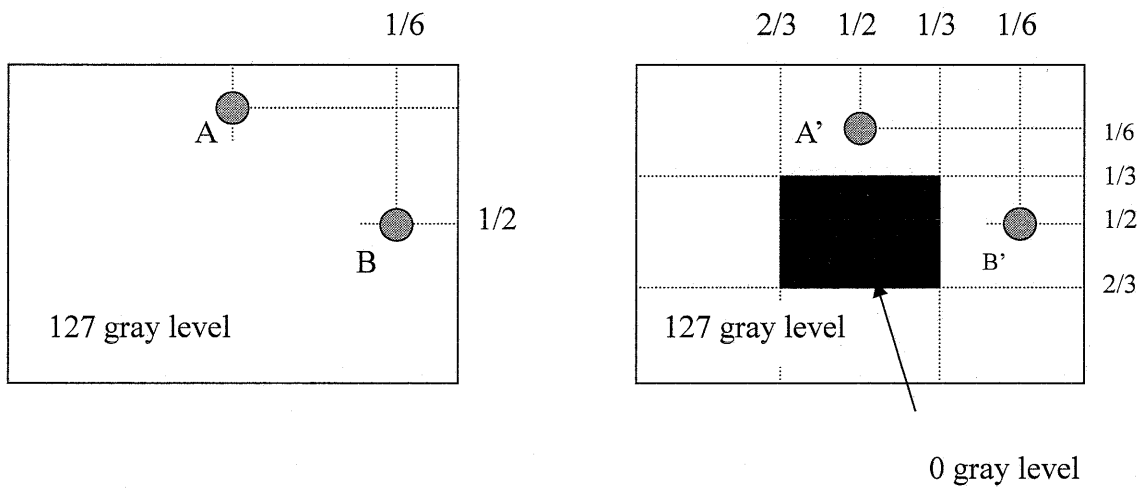

Unit: percentage of dimension of display area

$$|L_A - L_{A'}| / L_A \times 100\% = 2\% \text{ max.}, L_A \text{ and } L_{A'} \text{ are brightness at location A and A'}$$

$$|L_B - L_{B'}| / L_B \times 100\% = 2\% \text{ max.}, L_B \text{ and } L_{B'} \text{ are brightness at location B and B'}$$

Note 10: Optical characteristic measurement setup

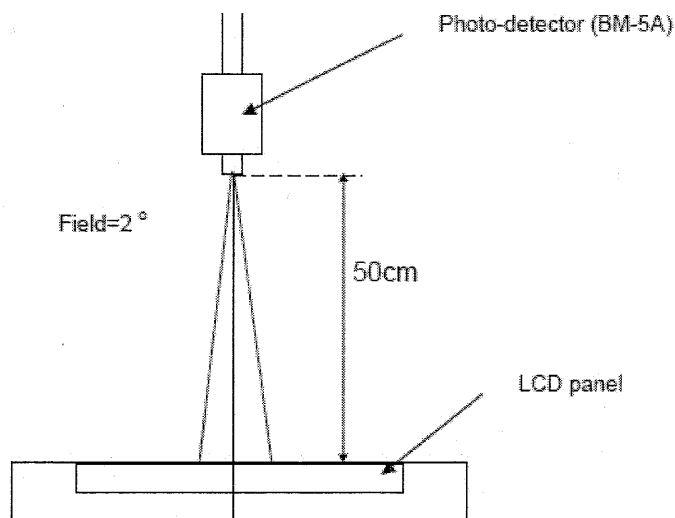

**D. Reliability test items**

Test Item	Test Condition	Judgement	Remark
High temperature storage	60°C, 40%RH, 240Hrs	Note 1	Note 2
Low temperature storage	-25°C, 240Hrs	Note 1	Note 2
High temperature & high humidity operation	40°C, 90%RH, 240Hrs (No condensation)	Note 1	Note 2
High temperature operation	50°C, 40%RH, 240Hrs	Note 1	Note 2
Low temperature operation	0°C, 240Hrs	Note 1	Note 2
Thermal Shock (non-operation)	-20°C~60°C 1Hr, 10mins, 1Hr, 100cycles	Note 1	Note 2
Electrostatic discharge (ESD) (non-operation)	150 pF, 330Ω, 10kV, 1 second, 9 position on the panel, 10 times each place	Note 1	Note 2
Vibration (Sine Wave) (non-operation)	Sweep: 1G, 10Hz ~ 500Hz ~ 10Hz / 30min 1 Hr for each direction X, Y, Z (3 Hrs in total)	Note 1	Note 2
Mechanical shock (non-operation)	50G/11ms, ±X, ±Y, ±Z once for each direction	Note 1	Note 2
MTBF Demonstration	50,000 hours with confidence level 90%	Note 1	Note 3

**Note 1 :**

Pass: Normal display image with no obvious non-uniformity and no line defect. Partial transformation of the module parts should be ignored.

Fail: No display image, obvious non-uniformity, or line defects.

**Note 2 :**

Evaluation should be tested after storage at room temperature for one hour.

**Note 3 :**

The MTBF calculation is based on the assumption that the failure rate distribution meets the Exponential Model.

## **E. Safety**

### **(1) Sharp Edge Requirements**

There will be no sharp edges or corners on the display assembly that could cause injury.

### **(2) Materials**

#### **a. Toxicity**

There will be no carcinogenic materials used anywhere in the display module. If toxic materials are used, they will be reviewed and approved by the responsible InnoLux Toxicologist.

#### **b. Flammability**

All components including electrical components that do not meet the flammability grade UL94-V1 in the module will complete the flammability rating exception approval process. The printed circuit board will be made from material rated 94-V1 or better. The actual UL flammability rating will be printed on the printed circuit board.

#### **C. Capacitors**

If any polarized capacitors are used in the display assembly, provisions will be made to keep them from being inserted backwards.

## **F. Display quality**

The display quality of the color TFT-LCD module should be in compliance with the Innolux's Incoming inspection standard.

## **G. Handling precaution**

The Handling of the TFT-LCD should be in compliance with the Innolux's handling principle standard.

**H. Label**

(1) Module Label

83 mm

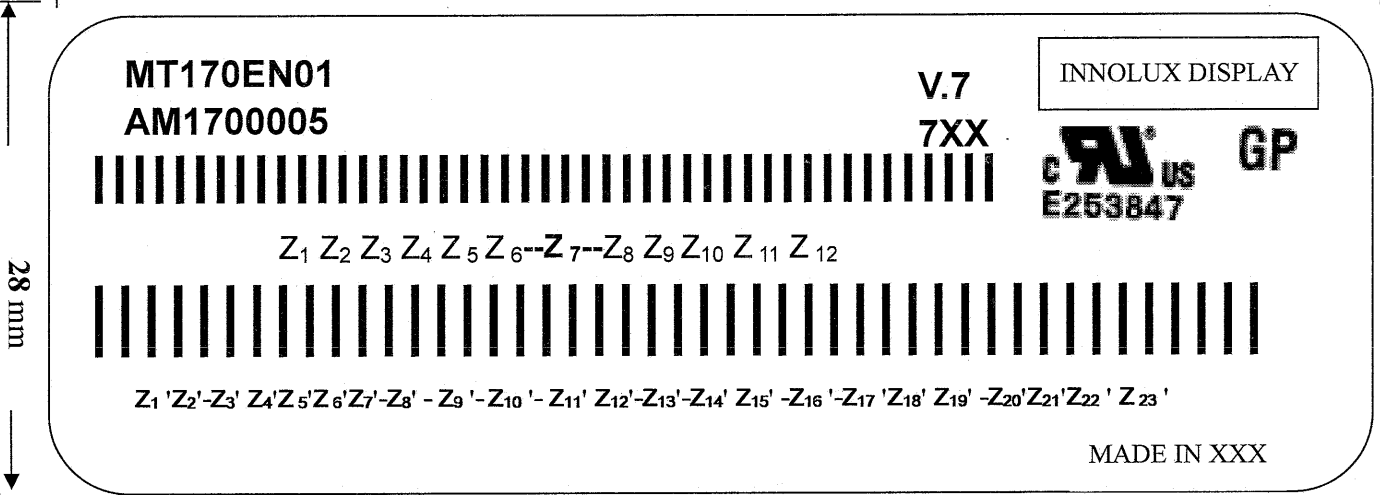

(a) Model Number : MT170EN01

(b) Version : V.7

(c) Serial ID I : Z<sub>1</sub> Z<sub>2</sub> Z<sub>3</sub> Z<sub>4</sub> Z<sub>5</sub> Z<sub>6</sub> Z<sub>7</sub> Z<sub>8</sub> Z<sub>9</sub> Z<sub>10</sub> Z<sub>11</sub> Z<sub>12</sub>

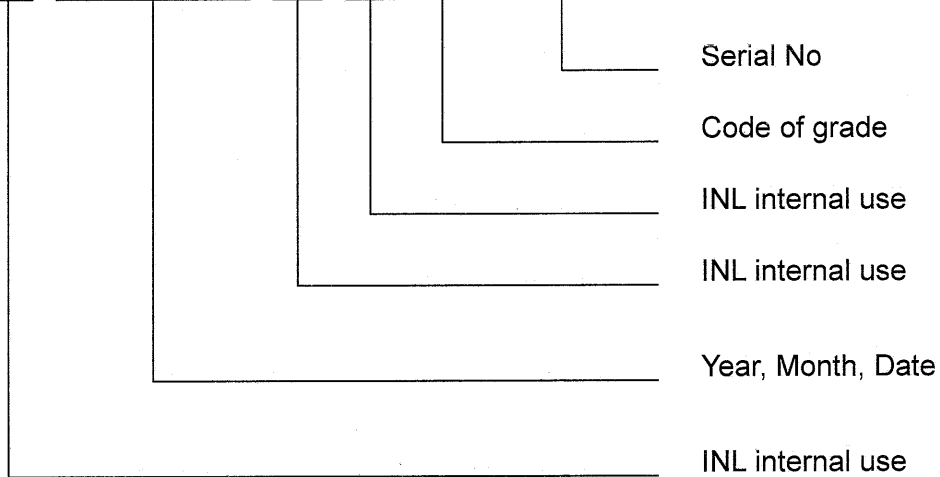

Serial ID includes the information as below :

1. Manufactured Date: Year: 0~9, for 2000~2009
2. Month: 1~9 & A~C for Jan.~Dec.
3. Date: 1~9 & A~Z (exclude I, O, Q, U) for 1th~31th
4. Code of grade: 1, 3, 5, 7, E
5. Serial No: Module manufacture sequential no

(e) Serial ID II (INL internal use)

(2) Carton Label

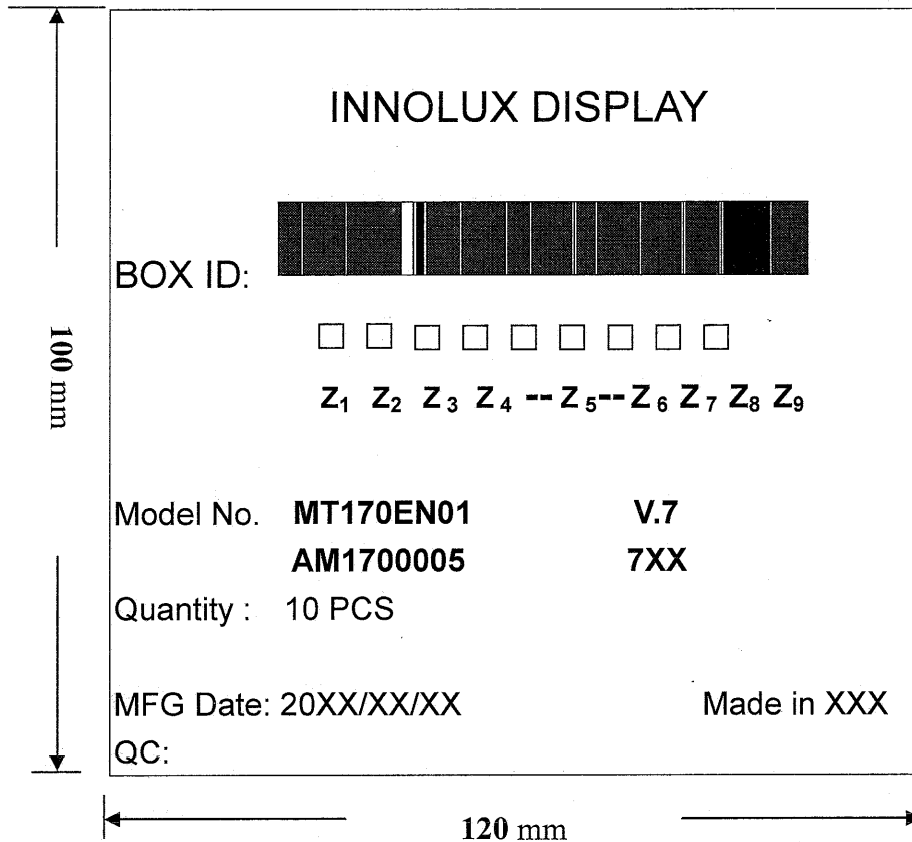

(a) Model Number : MT170EN01

(b) Version : V.7

(c) Packing quantity : 10 pcs

(d) Serial ID : Z<sub>1</sub> Z<sub>2</sub> Z<sub>3</sub> Z<sub>4</sub> Z<sub>5</sub> Z<sub>6</sub> Z<sub>7</sub> Z<sub>8</sub> Z<sub>9</sub>

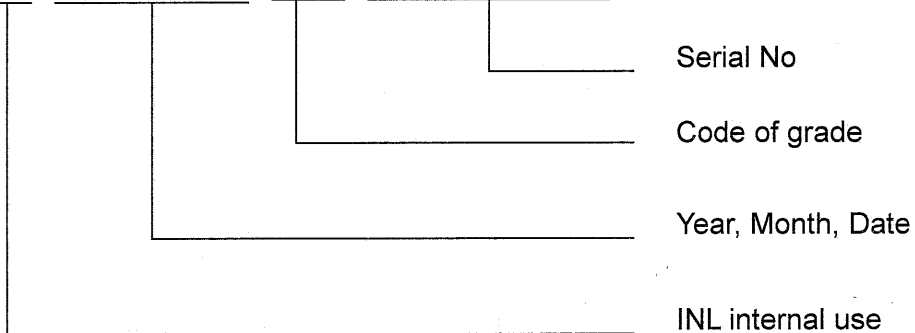

Serial ID includes the information as below :

(a) Manufactured Date: Year: 0~9, for 2000~2009

Month: 1~9 & A~C for Jan.~Dec.

Date: 1~9 & A~Z (exclude I, O, Q, U) for 1th~31th

(b) Code of grade: 1, 3, 5, 7, E

(c) Serial No: Module packing sequential no

### I. Packing form

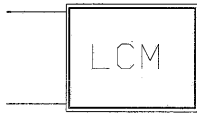

Cushion base-upper

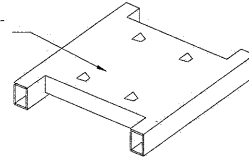

↓ Step A  
Put LCM into A/S bag

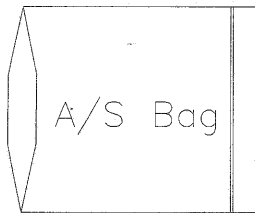

↓ Step B  
Turn back A/S bag

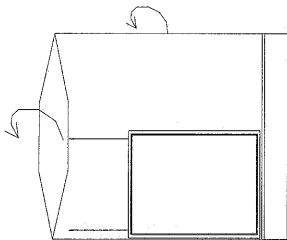

↓ Step C

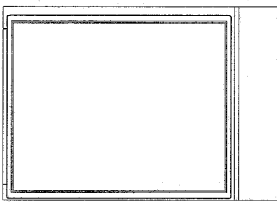

Step D

Put LCM with A/S bag into carton

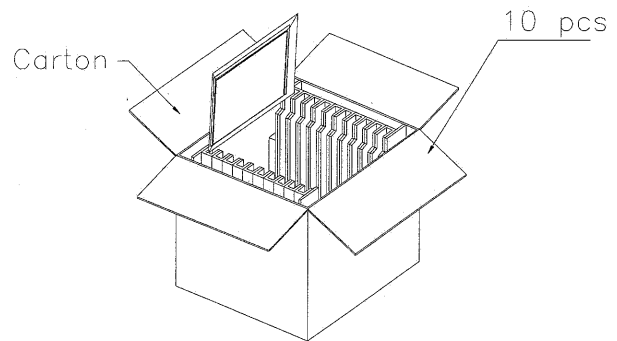

↓ Step E

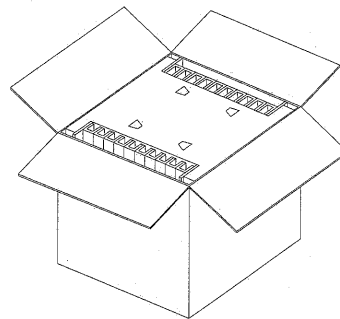

↓ Step F

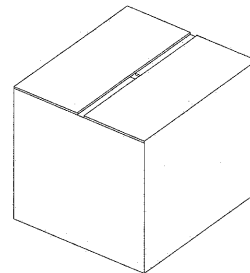

SPEC NO. MT170EN01 V.7

PAGE 23/24

J. ME Drawing  
(1) Front view

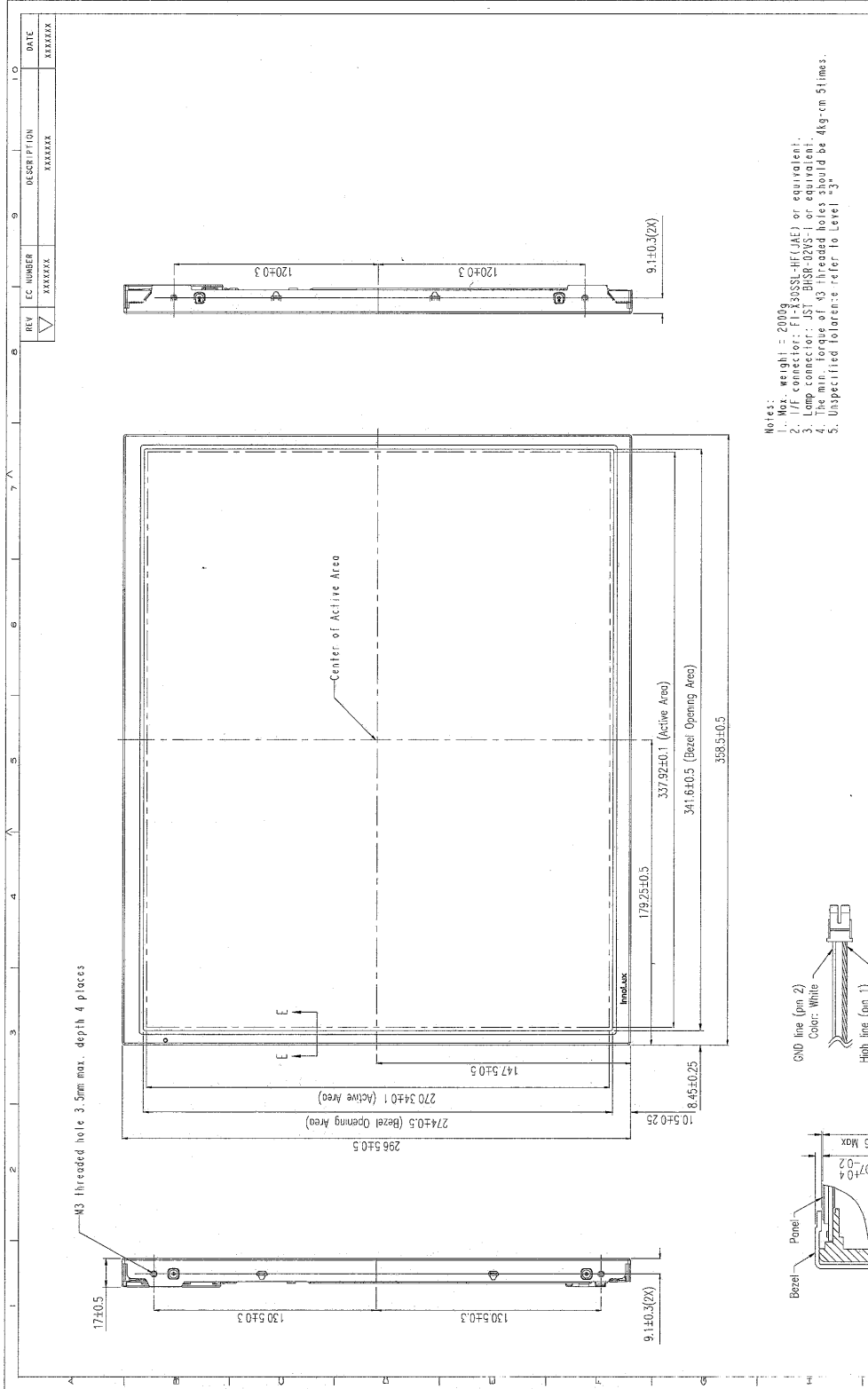

- Notes:
1. Max. weight: 2000g
  2. I/F connector: FI-20SSL-HF(JAE) or equivalent.
  3. Lamp connector: JST-BHSR-02V5-1 or equivalent.
  4. The min. torque of 43 threaded holes should be 4kg-cm 5times.
  5. Unspecified tolerance refer to Level 3.

GENERAL LINEAR TOLERANCE		FINISH		MATERIAL		CHECKED		DATE		PART NUMBER		REV		DESCRIPTION		DATE	
1	±0.1	1	1	1	1	1	1	1	1	1	1	1	1	1	1	1	1
2	±0.15	2	2	2	2	2	2	2	2	2	2	2	2	2	2	2	2
3	±0.2	3	3	3	3	3	3	3	3	3	3	3	3	3	3	3	3
4	±0.3	4	4	4	4	4	4	4	4	4	4	4	4	4	4	4	4
5	±0.5	5	5	5	5	5	5	5	5	5	5	5	5	5	5	5	5
6	±0.8	6	6	6	6	6	6	6	6	6	6	6	6	6	6	6	6
7	±1.0	7	7	7	7	7	7	7	7	7	7	7	7	7	7	7	7
8	±1.5	8	8	8	8	8	8	8	8	8	8	8	8	8	8	8	8
9	±2.0	9	9	9	9	9	9	9	9	9	9	9	9	9	9	9	9
10	±3.0	10	10	10	10	10	10	10	10	10	10	10	10	10	10	10	10

SECTION E-E  
SCALE 2.000

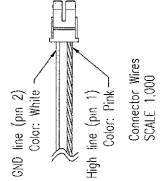

(2) Back view

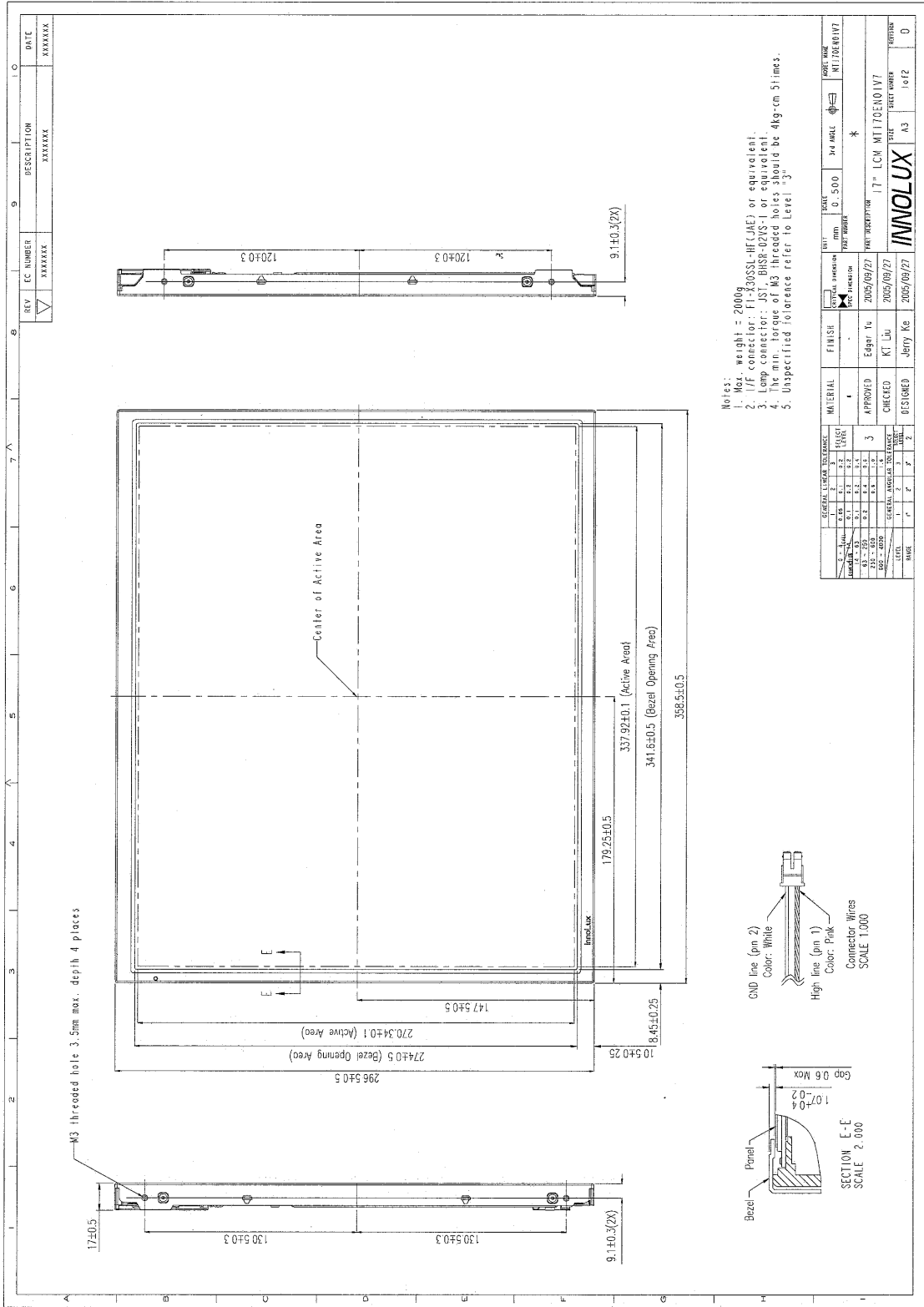

- Notes:
1. Max. weight = 2000g
  2. I/F connector: FI-3365SL-BF(JAE) or equivalent.
  3. Lamp connector: JST, BHSR-02VS-1 or equivalent.
  4. The min. torque of M3 threaded holes should be 4kg-cm 5times.
  5. Unspecified tolerance refer to Level "3"

REV	EC NUMBER	DESCRIPTION	DATE
1	XXXXXX	XXXXXX	XXXXXX

GENERAL	CONSTRUCTION	MATERIAL	FINISH	TEST	INSPECTION	DATE	BY
1	1	1	1	1	1	1	1
2	2	2	2	2	2	2	2
3	3	3	3	3	3	3	3
4	4	4	4	4	4	4	4
5	5	5	5	5	5	5	5
6	6	6	6	6	6	6	6
7	7	7	7	7	7	7	7
8	8	8	8	8	8	8	8
9	9	9	9	9	9	9	9
10	10	10	10	10	10	10	10
11	11	11	11	11	11	11	11
12	12	12	12	12	12	12	12
13	13	13	13	13	13	13	13
14	14	14	14	14	14	14	14
15	15	15	15	15	15	15	15
16	16	16	16	16	16	16	16
17	17	17	17	17	17	17	17
18	18	18	18	18	18	18	18
19	19	19	19	19	19	19	19
20	20	20	20	20	20	20	20
21	21	21	21	21	21	21	21
22	22	22	22	22	22	22	22
23	23	23	23	23	23	23	23
24	24	24	24	24	24	24	24
25	25	25	25	25	25	25	25
26	26	26	26	26	26	26	26
27	27	27	27	27	27	27	27
28	28	28	28	28	28	28	28
29	29	29	29	29	29	29	29
30	30	30	30	30	30	30	30
31	31	31	31	31	31	31	31
32	32	32	32	32	32	32	32
33	33	33	33	33	33	33	33
34	34	34	34	34	34	34	34
35	35	35	35	35	35	35	35
36	36	36	36	36	36	36	36
37	37	37	37	37	37	37	37
38	38	38	38	38	38	38	38
39	39	39	39	39	39	39	39
40	40	40	40	40	40	40	40
41	41	41	41	41	41	41	41
42	42	42	42	42	42	42	42
43	43	43	43	43	43	43	43
44	44	44	44	44	44	44	44
45	45	45	45	45	45	45	45
46	46	46	46	46	46	46	46
47	47	47	47	47	47	47	47
48	48	48	48	48	48	48	48
49	49	49	49	49	49	49	49
50	50	50	50	50	50	50	50