

MT170EN01 V.1 LCD MODULE SPECIFICATION

- () Preliminary Specification
(●) Final Specification

Customer	Checked & Approved by

Approved by	Checked by		Prepared by
MKT	QRA	PD	MKT

Date: _____

Innolux Display Corporation,

No.160 Kesyue Rd., Chu-Nan Site, Hsinchu Science Park,

Chu-Nan 350 , Miao-Li County, Taiwan

Tel: 886-37-586000

Fax: 886-37-586060

版權屬於群創所有，禁止任何未經授權之複製、轉載、或傳播。

The copyright belongs to INNOLUX. Any

Document Number: MT170EN01 V.1-D27

www.DataSheet4U.com

Record of Revision

Version	Revise Date	Page	Content
01	2005-03-09		First edition to all
02	2005-05-18	15	Add response time Tr and Tf value
		22/23	Revise Module Label and Carton Label



Contents:

A. General Specification

B. Electrical Specifications

1. Pin assignment

2. Absolute maximum ratings

3. Electrical characteristics

a. Typical operating conditions

b. Display color v.s. input data signals

c. Input signal timing

d. Display position

e. Backlight driving conditions

C. Optical specifications

D. Reliability test items

E. Safety

F. Display quality

G. Handling precaution

H. Label

I. Packing form

J. Mechanical drawings

Appendix

版權屬於群創所有，禁止任何未經授權的使用

A. General specification

www.DataSheet4U.com

NO.	Item	Specification	Remark
1	Display resolution (pixel)	1280(H) X 1024(V), SXGA resolution	
2	Active area (mm)	337.9(H) X 270.3(V)	
3	Screen size (inch)	17 inches diagonal	
4	Pixel pitch (mm)	0.264(H) X 0.264(V)	
5	Color configuration	R, G, B vertical stripe	
6	Overall dimension (mm)	358.5(W)x296.5(H)x17.5(D) Max	
7	Weight (g)	2000 max	
8	Surface treatment	Anti-glare, Haze = 25%, Hard coating (3H)	
9	Input color signal	8 bit LVDS	
10	Color saturation	72% NTSC	
11	Display colors	16.2M colors (6 bit with FRC)	
12	Optimum viewing direction	6 o'clock	
13	Backlight	4 CCFL, top & bottom edge side	

版權屬於群創所有，禁止任何未經授權的使用

B. Electrical specifications

1.Pin assignment

Connector JAE FI-X30SSL-HF or equivalent

Pin No	Symbol	Description
1	RxO0-	LVDS Differential data input Channel 0(-)
2	RxO0+	LVDS Differential data input Channel 0(+)
3	RxO1-	LVDS Differential data input Channel 1(-)
4	RxO1+	LVDS Differential data input Channel 1(+)
5	RxO2-	LVDS Differential data input Channel 2(-)
6	RxO2+	LVDS Differential data input Channel 2(+)
7	GND	Ground
8	RxOC-	LVDS Differential Clock input (-)
9	RxOC+	LVDS Differential Clock input (+)
10	RxO3-	LVDS Differential data input Channel 3(-)
11	RxO3+	LVDS Differential data input Channel 3(+)
12	RxE0-	LVDS Differential data input Channel 0(-)
13	RxE0+	LVDS Differential data input Channel 0(+)
14	GND	Ground
15	RxE1-	LVDS Differential data input Channel 1(-)
16	RxE1+	LVDS Differential data input Channel 1(+)
17	GND	Ground
18	RxE2-	LVDS Differential data input Channel 2(-)
19	RxE2+	LVDS Differential data input Channel 2(+)
20	RxEC-	LVDS Differential Clock input (-)
21	RxEC+	LVDS Differential Clock input (+)
22	RxE3-	LVDS Differential data input Channel 3(-)
23	RxE3+	LVDS Differential data input Channel 3(+)
24	GND	Ground
25	GND	Ground
26	GND	Ground or Open
27	GND	Ground
28	VCC	Power supply (+5.0V)
29	VCC	Power supply (+5.0V)
30	VCC	Power supply (+5.0V)



.com



Rear view of LCM

INNOVATION
Controlled

版權屬於群創所有，禁止任何未經授權的使用

2. Absolute maximum ratings

www.DataSheet4U.com

Parameter	Symbol	Values		Unit	Remark
		Min.	Max.		
Power voltage	V_{DD}	- 0.3	7.0	V	At 25°C
Input signal voltage	V_{LH}	- 0.3	3.6	V	At 25°C
Operating temperature	T_{op}	0	50	°C	Note 1
Storage temperature	T_{ST}	- 25	60	°C	Note 2
CCFL Current	ICFL	4	8	[mA] rms	
Re-screw			5	Times	
Assured Torque at Side Mount			4	[kgf.cm]	

Note 1: The relative humidity must not exceed 90% non-condensing at temperatures of 40°C or less. At temperatures greater than 40°C, the wet bulb temperature must not exceed 39°C.

Note 2: The unit should not be exposed to corrosive chemicals.

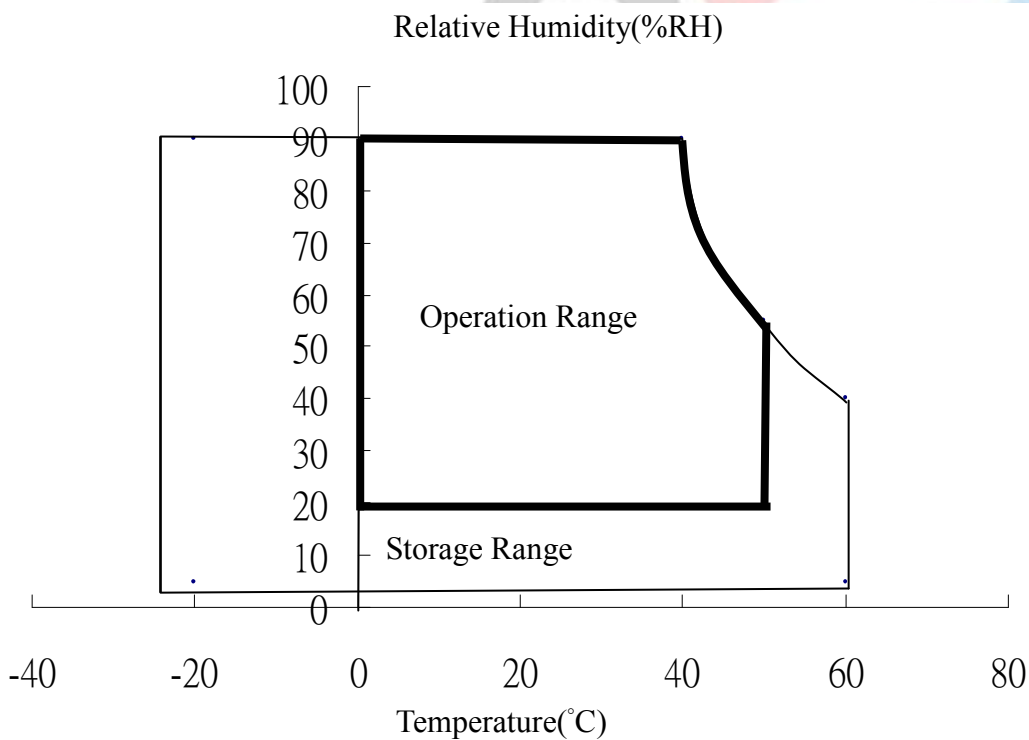

版權屬於群創所有，禁止任何未經授權的使用

3. Electrical characteristics

www.DataSheet4U.com

a. Typical operating conditions

Item	Symbol	Min.	Typ.	Max.	Unit	Remark	
Input Voltage	V_{DD}	4.5	5.0	5.5	V		
Permissive Power Input Ripple	V_{RF}	0.1	-	-	V	Note 1	
Input Current	I_{DD}	-	0.55	0.75	A	Note 2	
Differential Impedance	Z_m	90	100	110	ohm		
Power Consumption	P_C	-	2.75	3.75	Watts	Note 2	
Rush Current	I_{Rush}	-	2.0	3.0	A	Note 3	
Logic Input Voltage LVDS: IN+, IN-	Common Mode Voltage	VCM	1.125	1.25	1.375	V	
	Differential Input Voltage	VID	250	350	450	mV	
	Threshold Voltage (High)	VTH	-	-	100	mV	Note 4
	Threshold Voltage (Low)	VTL	-100			mV	Note 4

Note 1: Power input ripple should not exceed min. value.

Note 2: The specified current and power consumption are under the $V_{cc} = 5V$, $25\text{ }^\circ\text{C}$, $fV = 60\text{Hz}$ (frame frequency) condition whereas mosaic pattern (black & white [8*6]) is displayed.

White : 255 Gray

Black : 0Gray

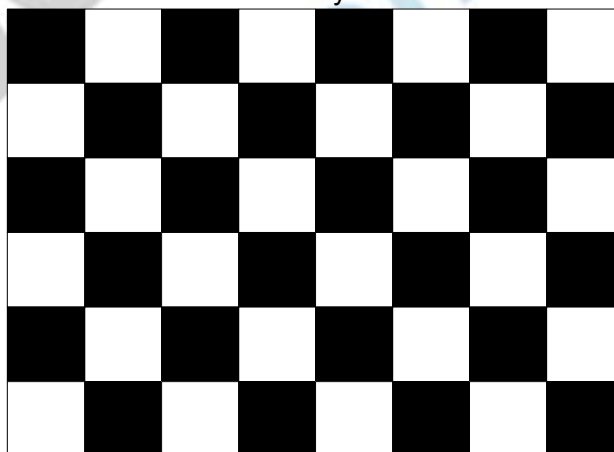

mosaic pattern (black & white [8*6])

版權屬於群創所有，禁止任何未經授權的使用

Note 3 : test condition :

- (1) $V_{DD} = 5\text{ V}$, V_{DD} rising time = $470\ \mu\text{s} \pm 10\%$
- (2) Pattern: Mosaic pattern

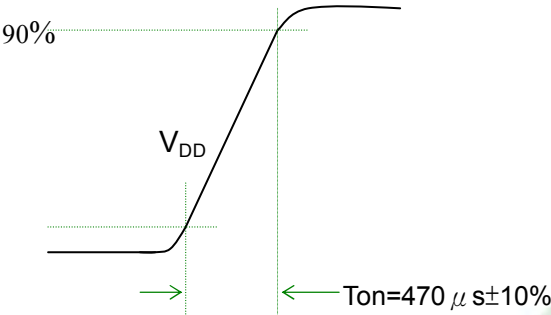

(3) Test circuit

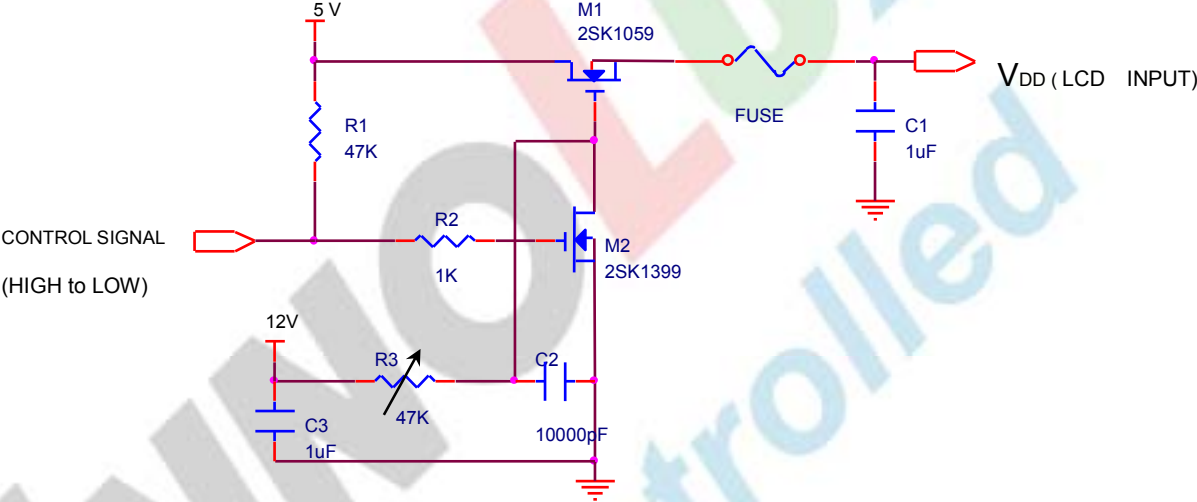

Note 4 : LVDS signal definition

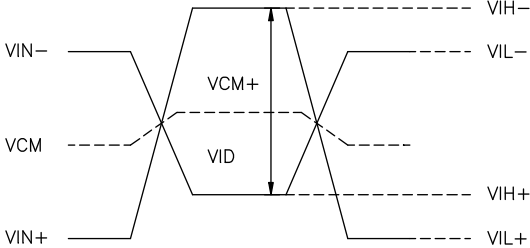
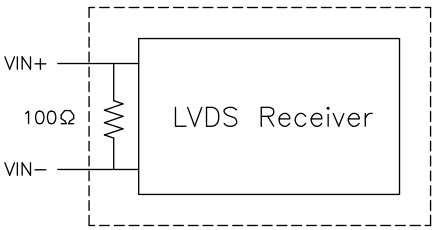

$VID = VIN_+ - VIN_-$,

$VCM = | VCM_+ - VCM_- |$,

$VID = | VID_+ - VID_- |$,

$VID_+ = | VIH_+ - VIH_- |$,

$VID_- = | VIL_+ - VIL_- |$,

$VCM = (VIN_+ + VIN_-)/2$,

$VCM_+ = (VIH_+ + VIH_-)/2$,

$VCM_- = (VIL_+ + VIL_-)/2$,

VIN_+ = Positive differential DATA & CLK Input

VIN_- = Negative differential DATA & CLK Input

Note 5 : Power on sequence for LCD V_{DD}

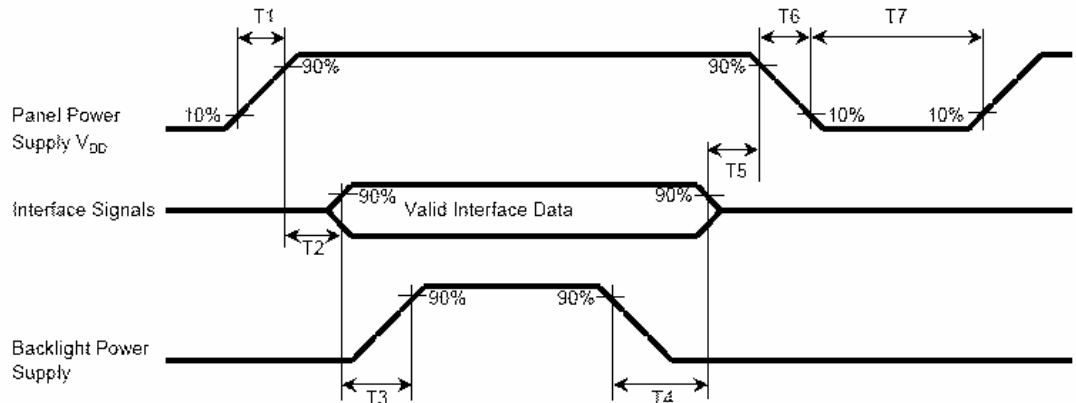

Parameter	Value			Unit
	Min	Typ	Max	
T1	0.1	--	10	ms
T2	0	--	10	ms
T3	200	250	--	ms
T4	100	250	--	ms
T5	0	20	50	ms
T6	0.1	--	10	ms
T7	1000	--	--	ms

版權屬於群創所有，禁止任何未經授權的使用

b. Display color v.s. input data signals

The brightness of each primary color (red, green and blue) is based on the 8-bit gray scale data input for the color; the higher the binary input, the brighter the color. The table below provides a reference for color versus data input.

Color	Input color data																							
	Red								Green								Blue							
	MSB				LSB				MSB				LSB				MSB				LSB			
	R7	R6	R5	R4	R3	R2	R1	R0	G7	G6	G5	G4	G3	G2	G1	G0	B7	B6	B5	B4	B3	B2	B1	B0
Basic colors	Black	0	0	0	0	0	0	0	0	0	0	0	0	0	0	0	0	0	0	0	0	0	0	0
	Red(255)	1	1	1	1	1	1	1	0	0	0	0	0	0	0	0	0	0	0	0	0	0	0	0
	Green(255)	0	0	0	0	0	0	0	1	1	1	1	1	1	1	1	0	0	0	0	0	0	0	0
	Blue(255)	0	0	0	0	0	0	0	0	0	0	0	0	0	0	0	1	1	1	1	1	1	1	1
	Cyan	0	0	0	0	0	0	0	1	1	1	1	1	1	1	1	1	1	1	1	1	1	1	1
	Magenta	1	1	1	1	1	1	1	0	0	0	0	0	0	0	0	1	1	1	1	1	1	1	1
	Yellow	1	1	1	1	1	1	1	1	1	1	1	1	1	1	1	0	0	0	0	0	0	0	0
	White	1	1	1	1	1	1	1	1	1	1	1	1	1	1	1	1	1	1	1	1	1	1	1
Red	Red(000) dark	0	0	0	0	0	0	0	0	0	0	0	0	0	0	0	0	0	0	0	0	0	0	0
	Red(001)	0	0	0	0	0	0	1	0	0	0	0	0	0	0	0	0	0	0	0	0	0	0	0
	Red(002)	0	0	0	0	0	1	0	0	0	0	0	0	0	0	0	0	0	0	0	0	0	0	0
	:	:	:	:	:	:	:	:	:	:	:	:	:	:	:	:	:	:	:	:	:	:	:	:
	Red(253)	1	1	1	1	1	0	1	0	0	0	0	0	0	0	0	0	0	0	0	0	0	0	0
	Red(254)	1	1	1	1	1	1	0	0	0	0	0	0	0	0	0	0	0	0	0	0	0	0	0
	Red(255) bright	1	1	1	1	1	1	1	0	0	0	0	0	0	0	0	0	0	0	0	0	0	0	0
Green	Green(000)dark	0	0	0	0	0	0	0	0	0	0	0	0	0	0	0	0	0	0	0	0	0	0	0
	Green(001)	0	0	0	0	0	0	0	0	0	0	0	0	0	0	1	0	0	0	0	0	0	0	0
	Green(002)	0	0	0	0	0	0	0	0	0	0	0	0	0	1	0	0	0	0	0	0	0	0	0
	:	:	:	:	:	:	:	:	:	:	:	:	:	:	:	:	:	:	:	:	:	:	:	:
	Green(253)	0	0	0	0	0	0	0	1	1	1	1	1	1	0	1	0	0	0	0	0	0	0	0
	Green(254)	0	0	0	0	0	0	0	1	1	1	1	1	1	1	0	0	0	0	0	0	0	0	0
	Green(255)bright	0	0	0	0	0	0	0	1	1	1	1	1	1	1	1	0	0	0	0	0	0	0	0
Blue	Blue(000) dark	0	0	0	0	0	0	0	0	0	0	0	0	0	0	0	0	0	0	0	0	0	0	0
	Blue(001)	0	0	0	0	0	0	0	0	0	0	0	0	0	0	0	0	0	0	0	0	0	0	1
	Blue(002)	0	0	0	0	0	0	0	0	0	0	0	0	0	0	0	0	0	0	0	0	0	1	0
	:	:	:	:	:	:	:	:	:	:	:	:	:	:	:	:	:	:	:	:	:	:	:	:
	Blue(253)	0	0	0	0	0	0	0	0	0	0	0	0	0	0	0	1	1	1	1	1	1	0	1
	Blue(254)	0	0	0	0	0	0	0	0	0	0	0	0	0	0	0	1	1	1	1	1	1	1	0
	Blue(255) bright	0	0	0	0	0	0	0	0	0	0	0	0	0	0	0	1	1	1	1	1	1	1	1

版權屬於群創所有，禁止任何未經授權的使用

c. Input signal timing

www.DataSheet4U.com

Support Input Timing Table

	Item	Description	Min.	Typ.	Max.	Unit
Clock	Dclk	period	14.71	18.52	22.22	nS
		frequency	45	54	68	MHz
Vertical	T_{V_TOTAL}	V total line number	1044	1066	1300	T_{H_TOTAL}
	T_{V_DATA}	Data duration	—	1024	—	T_{H_TOTAL}
	T_{VB}	V-blank	20	42		T_{H_TOTAL}
	f_V	frequency	50	60	75	Hz
Horizontal	T_{H_TOTAL}	H total pixel number	710	844	980	DCIk
	T_{H_DATA}	Data duration	—	640	—	DCIk
	T_{HB}	H-blank	70	204		DCIk

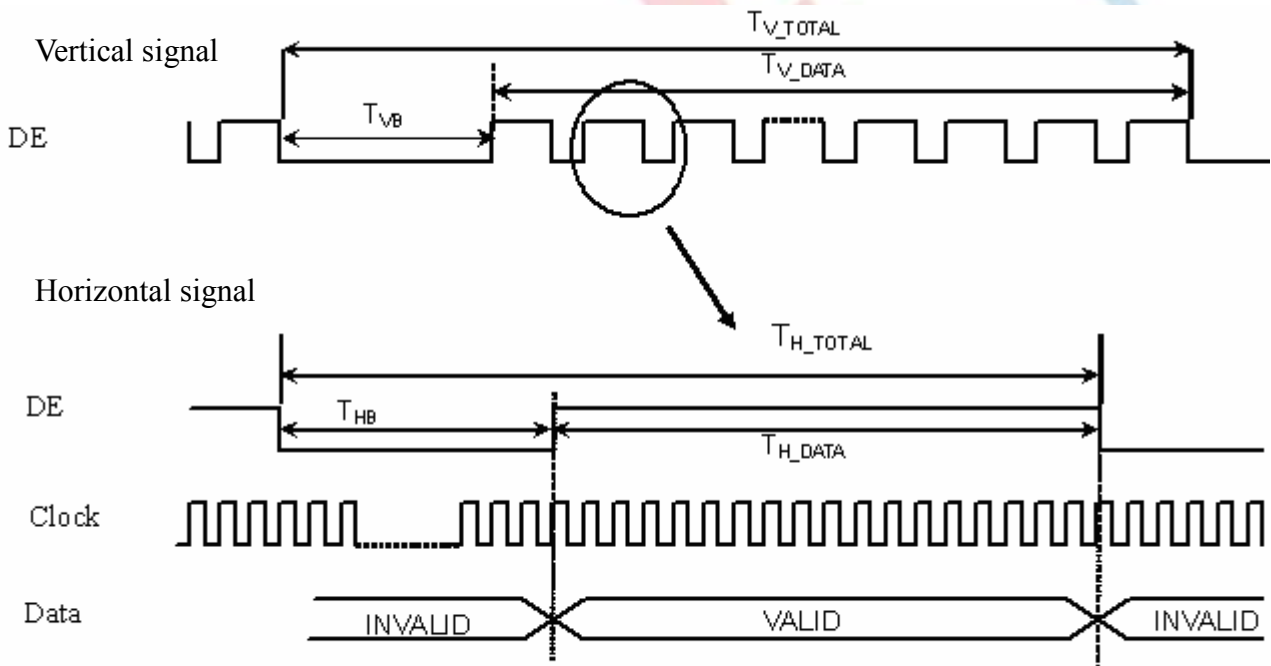

Note : DE is reference signal, DE means the display data valid.

版權屬於群創所有，禁止任何未經授權的使用

d. Display Position

D(1, 1)	D(2, 1)	D(640, 1)	D(1279, 1)	D(1280, 1)
D(1, 2)	D(2, 2)	D(640, 2)	D(1279, 2)	D(1280, 2)
⋮		⋮	⋮	⋮
D(1, 512)	D(2, 512)	D(640, 512)	D(1279, 512)	D(1280, 512)
⋮		⋮	⋮	⋮
D(1, 1023)	D(2, 1023)	D(640, 1023)	D(1279, 1023)	D(1280, 1023)
D(1, 1024)	D(2, 1024)	D(640, 1024)	D(1279, 1024)	D(1280, 1024)

e. Backlight driving conditions

Parameter	Symbol	Min.	Typ.	Max.	Unit	Remark	Remark
Lamp voltage	VL		610	700	Vrms		
Lamp operation current	IL	4	7	8	mA rms		Note 1
Power consumption	PL		17.08	22.4	W		
Lamp starting voltage	VLstart	1500			Vrms	T = 25 °C	Note 2,3,4,5
		1750				T = 0 °C	Note 2,3,4,5
Frequency	F	40	50	80	KHZ		Note 5
Lamp life time		40000			Hr		Note 6
		50000			Hr		Note 7

Note 1 :

The degrees of unbalance: less than 10%

The ratio of wave height: less than $\sqrt{2} \pm 10\%$

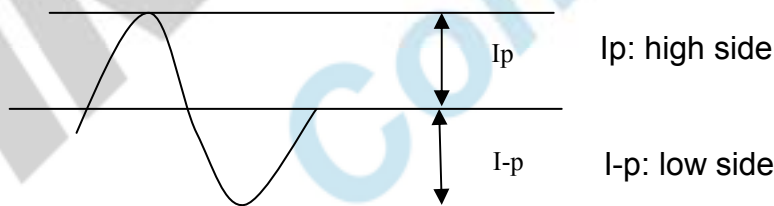

The degrees of unbalance = $|Ip - I-p| / Irms * 100(\%)$

The ratio of wave height = $Ip(\text{or } I-p) / Irms$

Lamp should be completely turned on.

Note 2:

Test equipment: AS-114B, Output Capacitor = 18pF, f=57KHz

Note 3:

The voltage shown above should be applied to the lamp for more than 1 second after startup.

Otherwise, the lamp may not be turned on normally.

版權屬於群創所有，禁止任何未經授權的使用

Note 4:

www.DataSheet4U.com

Inverter should provide more than min. value, and then lamp could be completely turned on

Note 5:

Lamp frequency may produce interference with horizontal synchronous frequency and this may cause line flow on the display. Therefore lamp frequency shall be detached from the horizontal synchronous frequency and its harmonics as far as possible in order to avoid interference.

Note 6:

Lamp life definition :

(A) Lamp current $I_L = (7) \text{ mA}$

(B) The brightness of lamp becomes 50% of the initial brightness or not normal lighting.

Note 7:

Lamp life definition :

(A) Lamp current $I_L = (4) \text{ mA}$

(B) The brightness of lamp becomes 50% of the initial brightness or not normal lighting.

Backlight connector : JST BHSR - 02VS-1

Pin no.	Symbol	Function	Remark
1	VIH	Lamp high voltage input	Cable color: Pink
2	VIL	Lamp low voltage input	Cable color: White

版權屬於群創所有，禁止任何未經授權的使用

C. Optical specifications

www.DataSheet4U.com

Item	Symbol	Condition	Specification			Unit	Remark
			Min.	Typ.	Max.		
Response time	Tr	$\theta = 0^\circ$		3	5	ms	Note 4
	Tf			9	11		
	Tr+Tf			12	16		
Contrast ratio	CR	$\theta = 0^\circ$	400	500			Note 3,5
Viewing angle	Top	$CR \geq 10$	60	70	deg	Note 3,5,7	
		$CR \geq 5$	70	80			
	Bottom	$CR \geq 10$	50	60			
		$CR \geq 5$	70	80			
	Left	$CR \geq 10$	60	70			
		$CR \geq 5$	70	80			
	Right	$CR \geq 10$	60	70			
		$CR \geq 5$	70	80			
Brightness (Center)	Y_L		250	300	nit	Note 3,6	
Color chromaticity(CIE)	W_x	$\theta = 0^\circ$	-0.03	0.313	+0.03	Note 3	
	W_y			0.329			
	R_x			0.640			
	R_y			0.349			
	G_x			0.284			
	G_y			0.617			
	B_x			0.142			
	B_y			0.067			
White uniformity (13)	δ_w		0.75	0.8		Note 3,8	
Cross talk	Ct				2%	Note 9	
TCO '03 A.2.3.4 (Luminance uniformity)	δ_{w2}				1.7	Note 10	
TCO '03 A.2.4.2 (Luminance contrast)	CR ₂		0.8			Note 11	

Note 1: Ambient temperature = 25°C.

Note 2: To be measured in dark room after backlight warm up 30 minutes.

Note 3: To be measured with a viewing cone of 2° by Topcon luminance meter BM-5A.

Note 4: Definition of response time:

The output signals of BM-7 are measured when the input signals are changed from "Black" to "White" (falling time) and from "White" to "Black" (rising time), respectively. The response time

interval between the 10% and 90% of amplitudes. Refer to figure as below.

www.DataSheet4U.com

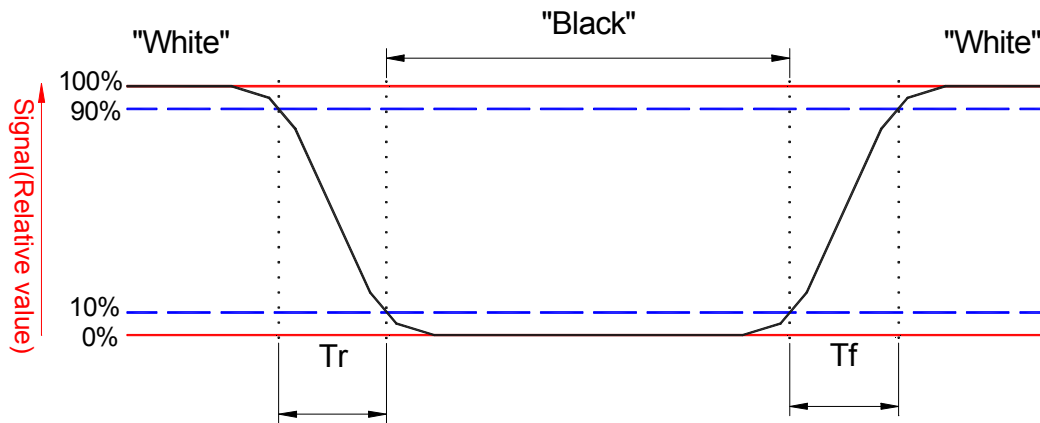

Note 5. Definition of contrast ratio:

Contrast ratio is calculated with the following formula.

$$\text{Contrast ratio (CR)} = \frac{\text{Brightness on the "white" state}}{\text{Brightness on the "black" state}}$$

Note 6: Driving conditions for CCFL: $I_L = 7.0 \text{ mA}$, 50 KHz Frequency.

Note 7: Definition of viewing angle

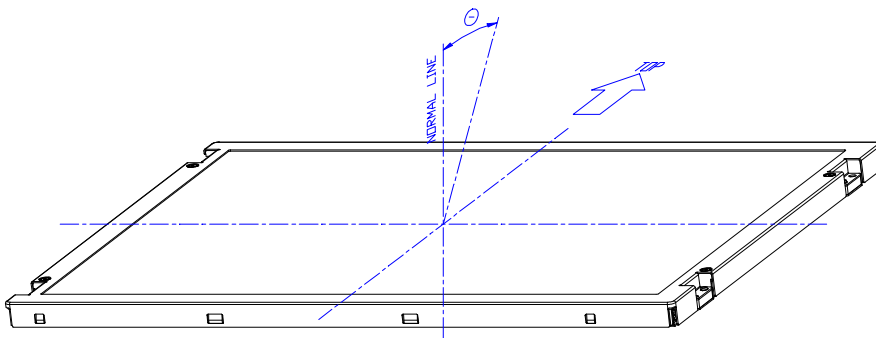

Note 8: Definition white uniformity:

Luminance are measured at the following thirteen points (1~13).

$$\delta_w = \frac{\text{Minimum Brightness of thirteen points}}{\text{Maximum Brightness of thirteen points}}$$

版權屬於群創所有，禁止任何未經授權的使用

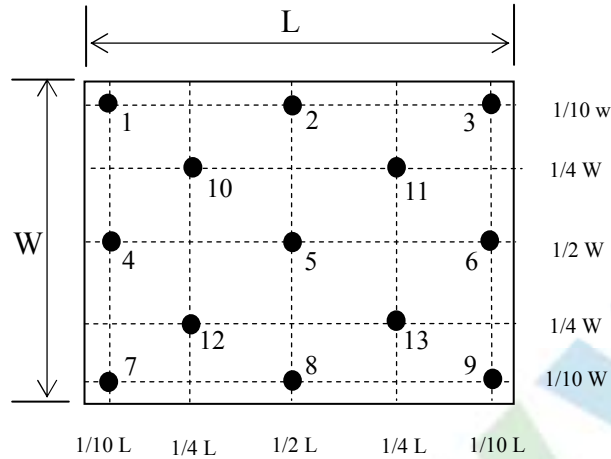

Note 9:

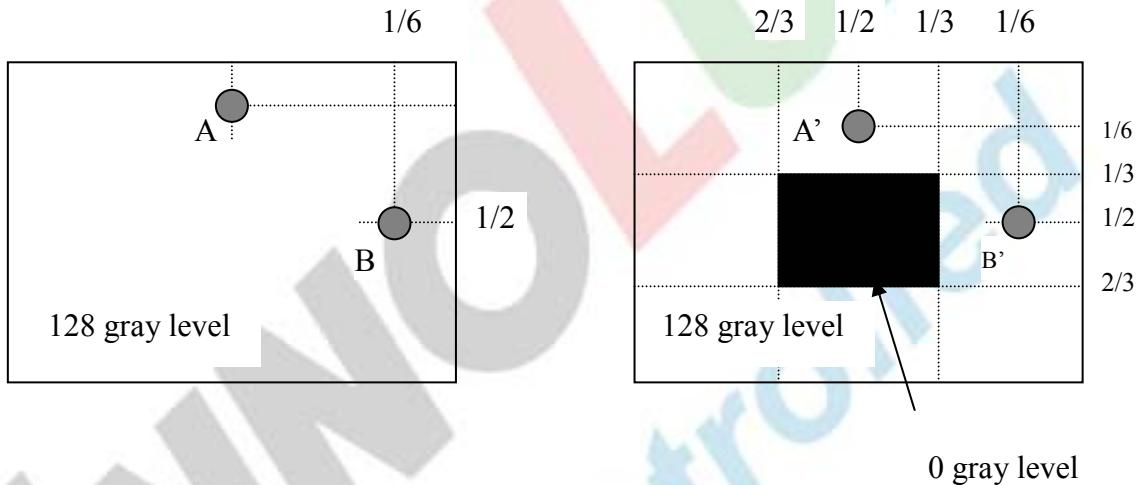

Unit: percentage of dimension of display area

$$|L_A - L_{A'}| / L_A \times 100\% = 2\% \text{ max.}, L_A \text{ and } L_{A'} \text{ are brightness at location A and } A'$$

$$|L_B - L_{B'}| / L_B \times 100\% = 2\% \text{ max.}, L_B \text{ and } L_{B'} \text{ are brightness at location B and } B'$$

Note 10:

TCO'03 A.2.3.4: Luminance uniformity - angular dependence.

1. Refer to Fig.1&2, for FPDs in the horizontal direction, the mean value of the Lmax. to Lmin. ratios at ± 30 degrees shall be $\square 1.7$.

$$\text{Formula: } \frac{\left(\frac{L + 30 \text{ max.}}{L + 30 \text{ min.}}\right) + \left(\frac{L - 30 \text{ max.}}{L - 30 \text{ min.}}\right)}{2} \leq 1.7$$

2. Refer to Fig.1&3, for FPDs in the vertical direction, the value of Lmax. to Lmin. ratio at +15 degree shall be $\square 1.7$ and the largest value of Lmax. to Lmin. ratio at ± 15 degree shall be

$$\text{Formula: } \frac{L + 15 \text{ max.}}{L + 15 \text{ min.}} \leq 1.7$$

$$\text{Formula: } \text{Max.} \left(\frac{L + 15 \text{ max.}}{L + 15 \text{ min.}}, \frac{L - 15 \text{ max.}}{L - 15 \text{ min.}} \right) \leq 1.7$$

Note 11:

www.DataSheet4U.com

TCO'03 A.2.4.2: Luminance contrast – angular dependence.

Refer to Fig.1&2, center point(Pc) Luminance of White(Lw) and Black(LB) is measured at ±30 degrees.

The luminance contrast values C₊₃₀, C₋₃₀, shall be calculated using the formula:

$$C = \frac{Lw - LB}{Lw + LB}$$

For FPDs, Min.(C₊₃₀, C₋₃₀) shall be ≥0.8 and reported as luminance contrast.

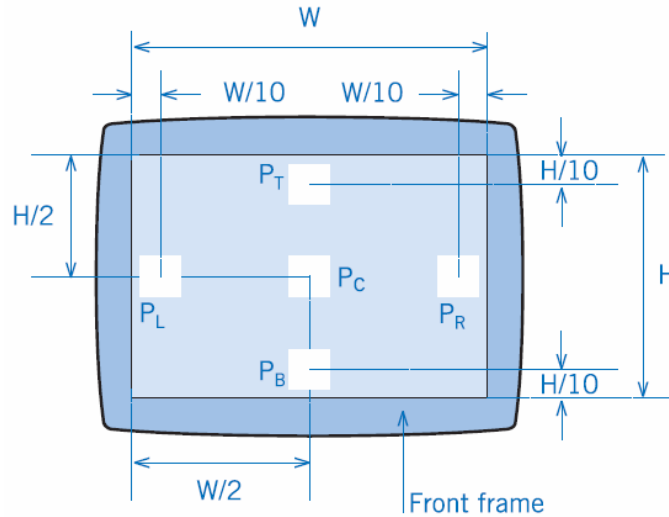

Figure1: Measurement positions for angular dependence luminance uniformity.

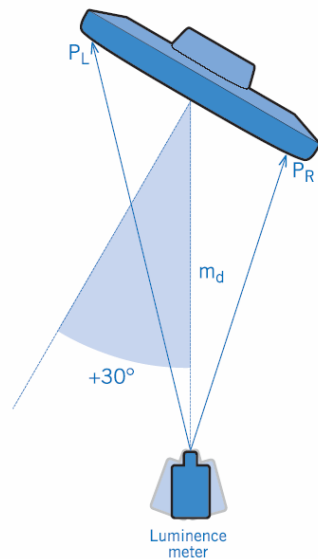

Figure2: Top view of test set-up when the screen is rotated ±30 degrees. The +rotation is defined clockwise.

版權屬於群創所有，禁止任何未經授權的使用

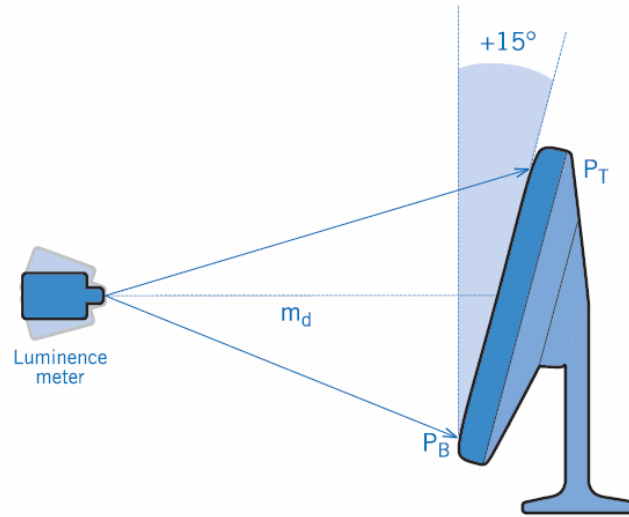

Figure3: Side view of the test set-up when the screen is tilted 15 degrees backwards.

INNO LUX
Controlled

版權屬於群創所有，禁止任何未經授權的使用

D. Reliability test items

Test Item	Test Condition	Judgement	Remark
High temperature storage	60°C, 40%RH ,240Hrs	Note 1	Note 2
Low temperature storage	-25°C, 240Hrs	Note 1	Note 2
High temperature & high humidity operation	40°C, 90%RH,240Hrs (No condensation)	Note 1	Note 2
High temperature operation	50°C, 40%RH, 240Hrs	Note 1	Note 2
Low temperature operation	0°C, 240Hrs	Note 1	Note 2
Thermal Shock (non-operation)	-20°C~60°C 1Hr, 10mins, 1Hr, 100cycles	Note 1	Note 2
Electrostatic discharge (ESD) (non-operation)	150 pF,330Ω,10kV,1 second, 9 position on the panel, 10 times each place	Note 1	Note 2
Vibration (Sine Wave) (non-operation)	Sweep:1G, 10Hz ~ 500Hz ~ 10Hz /30min 1 Hr for each direction X, Y, Z (3 Hrs in total)	Note 1	Note 2
Vibration (Random) (package) (non-operation)	0.015G2/Hz from 5~200Hz -6dB/Octave from 200~500Hz 1 Hr for each direction X,Y,Z (3 Hrs in total)	Note 1	Note 2
Drop (package)	50cm/1corner,3edges,6sides	Note 1	Note 2
Mechanical shock (non-operation)	200G/2ms, ±X, ±Y, ±Z once for each direction	Note 1	Note 2

Note 1 :

Pass: Normal display image with no obvious non-uniformity and no line defect.
Partial transformation of the module parts should be ignored.

Fail: No display image, obvious non-uniformity, or line defects.

Note 2 :

Evaluation should be tested after storage at room temperature for one hour.

E. Safety

(1) Sharp Edge Requirements

There will be no sharp edges or corners on the display assembly that could cause injury.

(2) Materials

a. Toxicity

There will be no carcinogenic materials used anywhere in the display module. If toxic materials are used, they will be reviewed and approved by the responsible InnoLux Toxicologist.

b. Flammability

All components including electrical components that do not meet the flammability grade UL94-V1 in the module will complete the flammability rating exception approval process. The printed circuit board will be made from material rated 94-V1 or better. The actual UL flammability rating will be printed on the printed circuit board.

C. Capacitors

If any polarized capacitors are used in the display assembly, provisions will be made to keep them from being inserted backwards.

F. Display quality

The display quality of the color TFT-LCD module should be in compliance with the InnoLux's Incoming inspection standard.

G. Handling precaution

The Handling of the TFT-LCD should be in compliance with the InnoLux's handling principle standard.

版權屬於群創所有，禁止任何未經授權的使用

H. Label

(1) Module Label

← 83 mm →

↑ 28 mm ↓

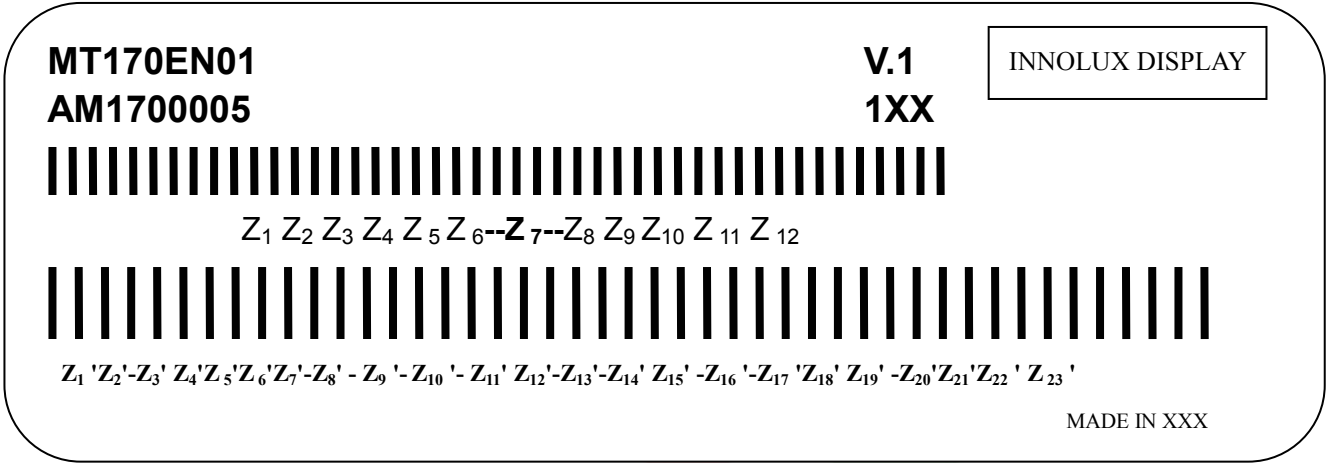

(a) Model Number : MT170EN01

(b) Version : V.1

(c) Serial ID I : Z_1 Z_2 Z_3 Z_4 Z_5 Z_6 Z_7 Z_8 Z_9 Z_{10} Z_{11} Z_{12}

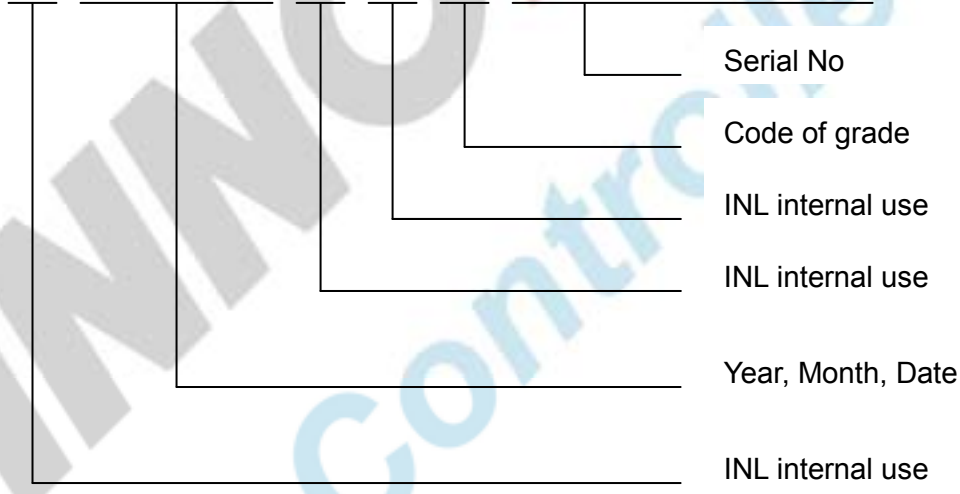

Serial ID includes the information as below :

1. Manufactured Date: Year: 0~9, for 2000~2009
2. Month: 1~9 & A~C for Jan.~Dec.
3. Date: 1~9 & A~Z (exclude I, O, Q, U) for 1th~31th
4. Code of grade: 1, 3, 5, 7, E
5. Serial No: Module manufacture sequential no

(e) Serial ID II (INL internal use)

版權屬於群創所有. 禁止任何未經授權的使用

(2) Carton Label

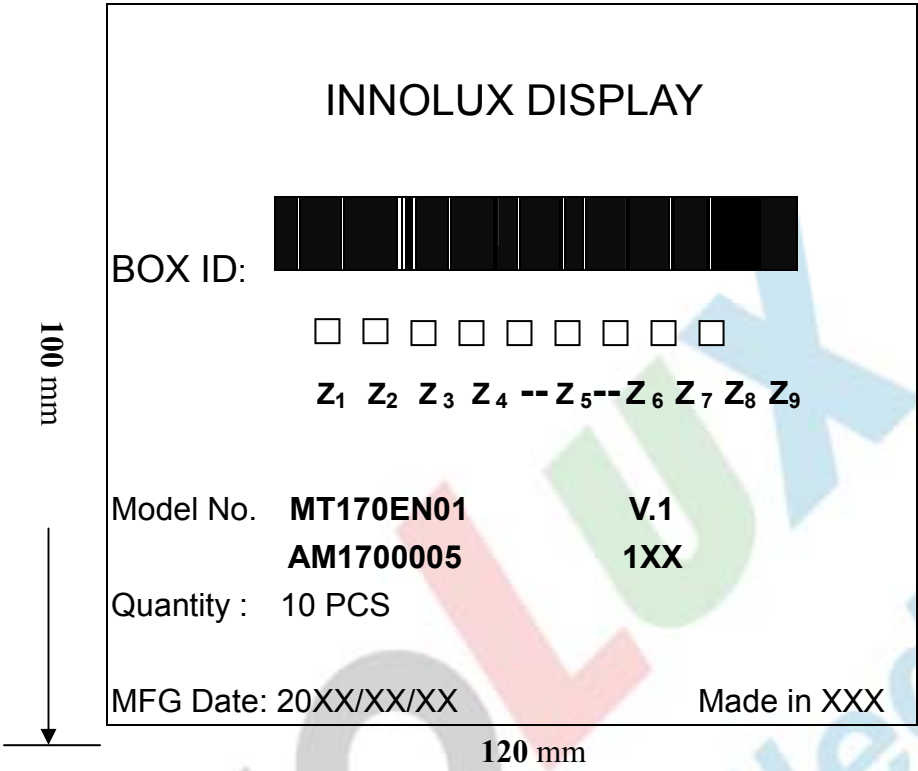

(a) Model Number : MT170EN01

(b) Version : V.1

(c) Packing quantity : 10 pcs

(d) Serial ID : Z₁ Z₂ Z₃ Z₄ Z₅ Z₆ Z₇ Z₈ Z₉

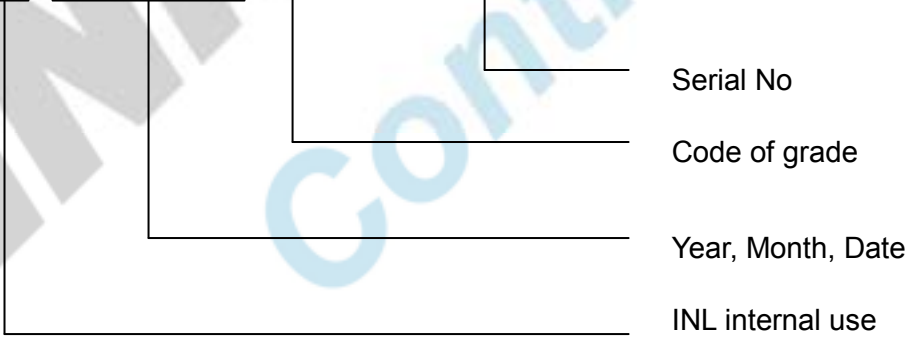

Serial ID includes the information as below :

- (a) Manufactured Date: Year: 0~9, for 2000~2009
 Month: 1~9 & A~C for Jan.~Dec.
 Date: 1~9 & A~Z (exclude I, O, Q, U) for 1th~31th
- (b) Code of grade: 1, 3, 5, 7, E
- (c) Serial No: Module packing sequential no

版權屬於群創所有. 禁止任何未經授權的使用

I. Packing form



Cushion base-upper

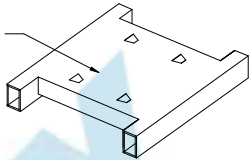

Step A
Put LCM into A/S bag

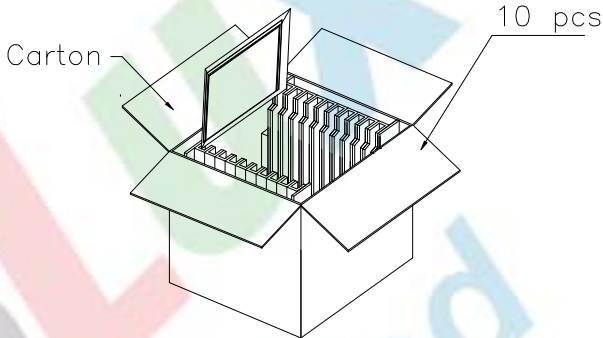
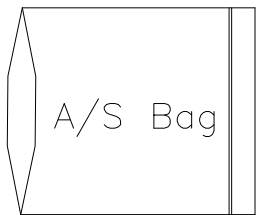

Step B
Turn back A/S bag

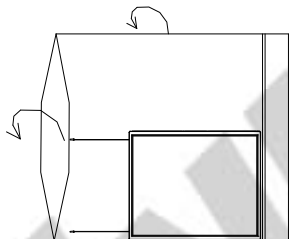

Step E

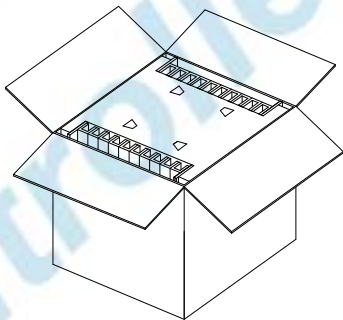

Step C



Step F

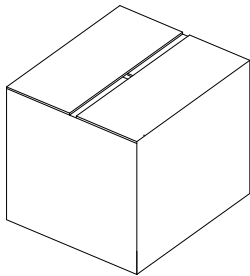

Step D
Put LCM with A/S bag into carton

版權屬於群創所有，禁止任何未經授權的使用

J. ME Drawing
(1) Front view

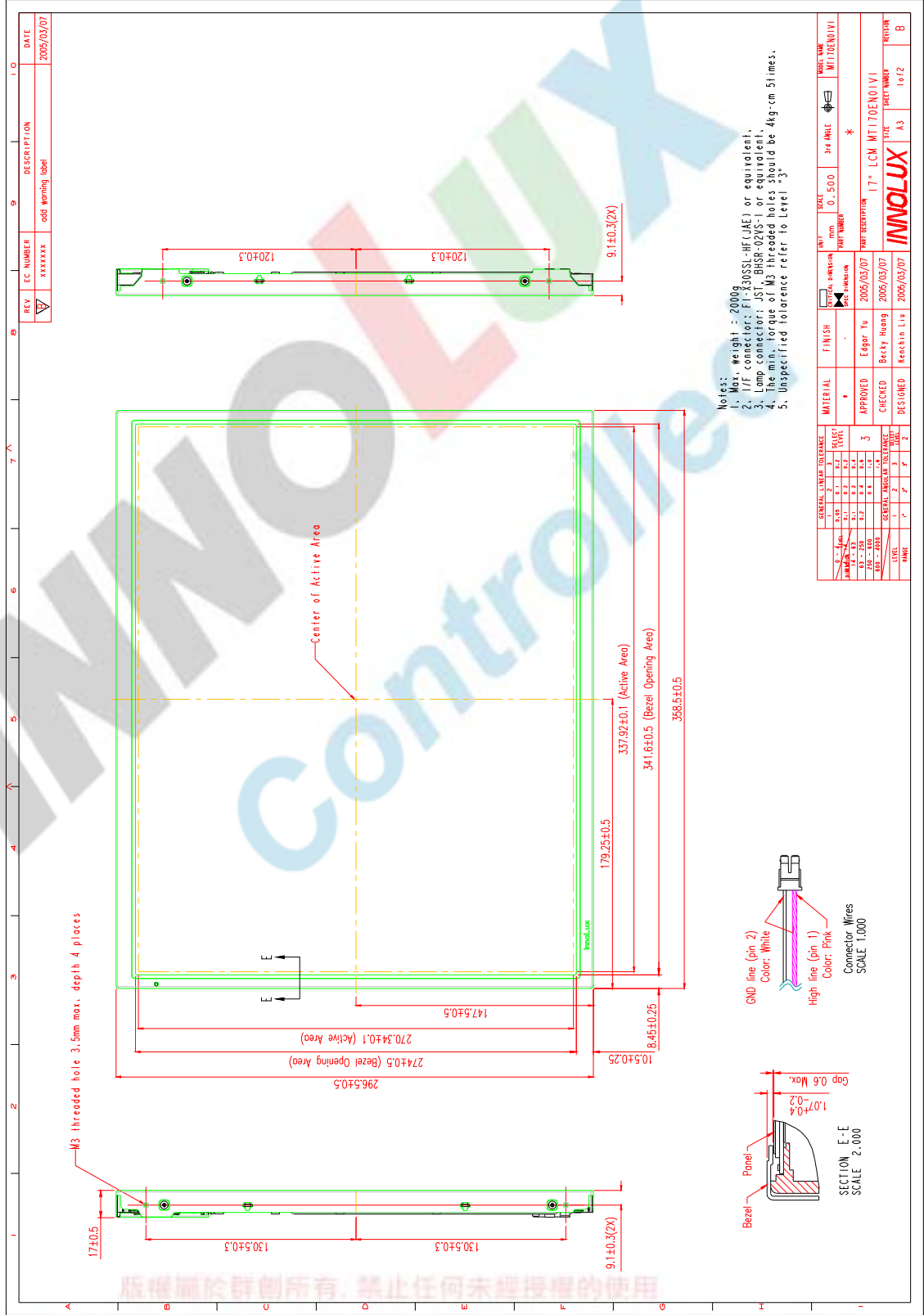

SPEC NO. :

PAGE : 23/23

(2) Back view

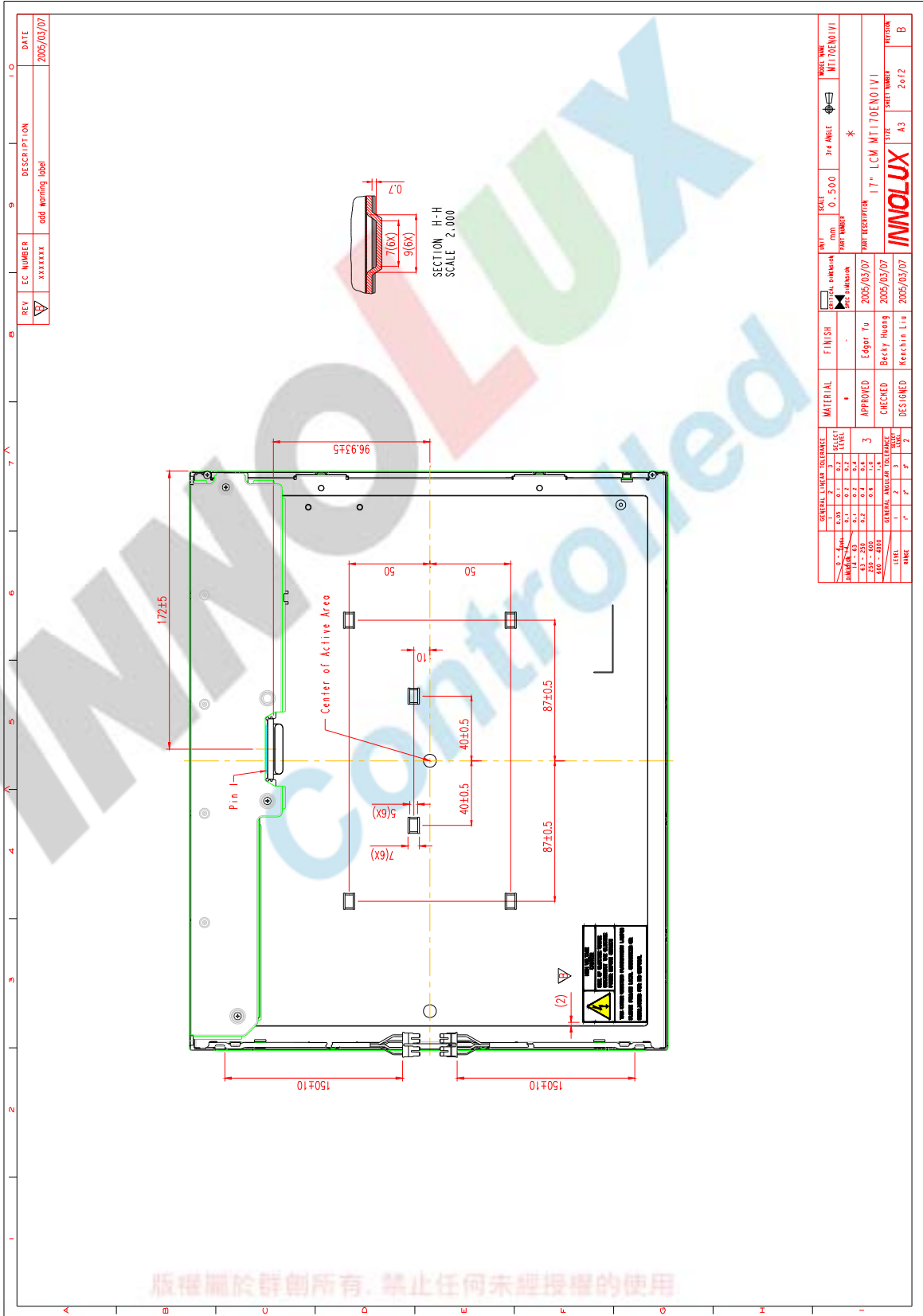

REV	EC NUMBER	DESCRIPTION	DATE
1	XXXXXX	add warning label	2005/03/07

GENERAL LINEAR TOLERANCE				SELECT LEVEL				UNIT	SCALE	3rd ANGLE	SHEET NUMBER	TOTAL SHEETS							
0.1 - 0.25	0.1	0.2	0.2	0.1	0.2	0.2	0.2												
0.1	0.1	0.1	0.1	0.1	0.1	0.1	0.1	mm	0:500	*	17"	LCM MT170EN01V1							
0.25 - 0.50	0.2	0.2	0.2	0.2	0.2	0.2	0.2												
0.5 - 1.00	0.2	0.2	0.2	0.2	0.2	0.2	0.2												
1.00 - 2.00	0.4	0.4	0.4	0.4	0.4	0.4	0.4												
2.00 - 5.00	0.8	0.8	0.8	0.8	0.8	0.8	0.8												
5.00 - 10.00	1.0	1.0	1.0	1.0	1.0	1.0	1.0												
GENERAL ANGULAR TOLERANCE				SELECT LEVEL				FINISH	MATERIAL	APPROVED	CHECKED	DESIGNED	DATE						
1	2	3	4	1	2	3	4												
1	1	1	1	1	1	1	1	Edge Tu		Edge Tu	Beky Hoang	2005/03/07	17"	LCM MT170EN01V1					
2	2	2	2	2	2	2	2				Keachin Liu	2005/03/07			A3	2 of 2			
3	3	3	3	3	3	3	3												
4	4	4	4	4	4	4	4												
INNO LUX												DATE	SHEET NUMBER		TOTAL SHEETS				
INNO LUX													A3		2 of 2				
INNO LUX													B						

版權屬於群創所有。禁止任何未經授權的使用

The copyright belongs to INNOLUX. Any unauthorized use is prohibited.

ALL RIGHTS STRICTLY RESERVED. ANY PORTION OF THIS PRPER SHALL NOT BE REPRODUCED, COPIED, OR TRANSFORMED TO ANY OTHER FORMS WITHOUT PERMISSION FROM INNOLUX DISPLAY CORPORATION.

BDTIC 半导体事业部代理群创光电产品

www.DataSheet4U.com

<http://www.BDTIC.com/Innolux>

龙人旗下深圳市龙芯世纪科技有限公司BDTIC 半导体事业部
www.DataSheet4U.com