

P-Channel Enhancement Mode Field Effect Transistor

FEATURES

- Super high dense cell design for low $R_{DS(ON)}$
- Rugged and reliable
- Simple drive requirement
- SOT-23 package

PRODUCT SUMMARY		
V_{DSS}	I_D	$R_{DS(ON)}$ (m Ω) Typ
-20V	-4.6A	70 @ $V_{GS}=-4.5V$
		95 @ $V_{GS}=-2.5V$



NOTE: The MT2307 is available in a lead-free package

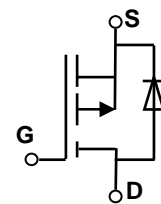
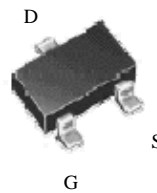

ABSOLUTE MAXIMUM RATINGS ($T_A=25^\circ C$ unless otherwise noted)

Parameter	Symbol	Limit	Unit
Drain-Source Voltage	V_{DS}	-20	V
Gate-Source Voltage	V_{GS}	± 12	V
Drain Current-Continuous ^a @ $T_j=125^\circ C$ - Pulse d^b	I_D	-4.6	A
	I_{DM}	-12	A
Drain-source Diode Forward Current ^a	I_S	-1.25	A
Maximum Power Dissipation ^a	P_D	1.25	W
Operating Junction and Storage Temperature Range	T_j, T_{STG}	-55 to 150	$^\circ C$

THERMAL CHARACTERISTICS

Thermal Resistance, Junction-to Ambient ^a	$R_{th JA}$	100	$^\circ C/W$
--	-------------	-----	--------------

ELECTRICAL CHARACTERISTICS (TA=25 °C unless otherwise noted)

Parameter	Symbol	Condition	Min	Typ	Max	Unit
OFF CHARACTERISTICS						
Drain-Source Breakdown Voltage	BV _{DSS}	V _{GS} =0V, I _D =-250μA	-20			V
Zero Gate Voltage Drain Current	I _{DSS}	V _{DS} =-16V, V _{GS} =0V			1	μA
Gate-Body Leakage	I _{GSS}	V _{GS} =±10V, V _{DS} =0V			±100	nA
ON CHARACTERISTICS						
Gate Threshold Voltage	V _{GS(th)}	V _{DS} =V _{GS} , I _D =-250μA	-0.5	-0.8	-1.5	V
Drain-Source On-State Resistance	R _{DS(ON)}	V _{GS} =-4.5V, I _D =-2.8A		70	90	mΩ
		V _{GS} =-2.5V, I _D =-2.0A		95	115	
Forward Transconductance	g _{FS}	V _{GS} =-5V, I _D =-5A		5		S
DYNAMIC CHARACTERISTICS						
Input Capacitance	C _{ISS}	V _{DS} =-10V, V _{GS} =0V f=1.0MHz		586		pF
Output Capacitance	C _{OSS}			101		pF
Reverse Transfer Capacitance	C _{RSS}			59		pF
SWITCHING CHARACTERISTICS						
Turn-On Delay Time	t _{D(ON)}	V _{DD} =-10V I _D =-2.8A, V _{GEN} =-4.5V R _L =10ohm R _{GEN} =6ohm		6.5		ns
Rise Time	t _r			32.1		ns
Turn-Off Delay Time	t _{D(OFF)}			58.4		ns
Fall Time	t _f			48		ns
Total Gate Charge	Q _g	V _{DS} =-10V, I _D =-3A V _{GS} =-4.5V		6		nC
Gate-Source Charge	Q _{gs}			1.35		nC
Gate-Drain Charge	Q _{gd}			1.5		nC

ELECTRICAL CHARACTERISTICS (TA=25°C unless otherwise noted)

Parameter	Symbol	Condition	Min	Typ	Max	Unit
DRAIN-SOURCE DIODE CHARACTERISTICS						
Diode Forward Voltage	VSD	VGS=0V, Is=-1.25A		-0.81	-1.2	V

Notes

- a. Surface Mounted on FR4 Board, $t \leq 10\text{sec}$
- b. Pulse Test: Pulse Width $\leq 300\mu\text{s}$, Duty Cycle $\leq 2\%$
- c. Guaranteed by design, not subject to production testing.

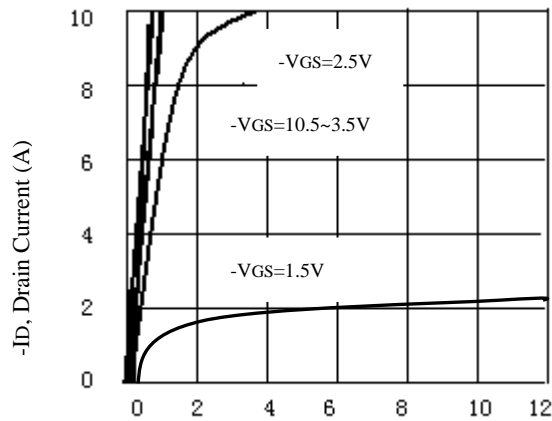

- V_{DS}, Drain-to-Source Voltage (V)
Figure 1. Output Characteristics

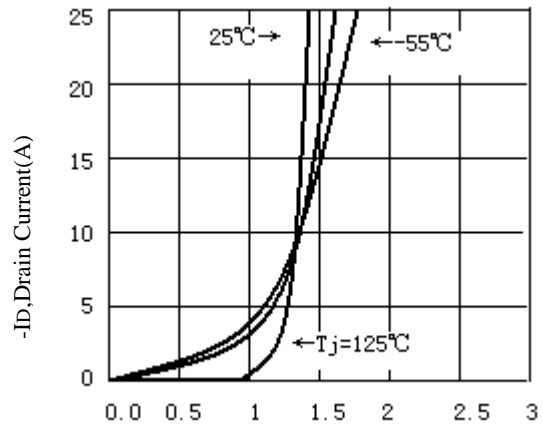

-V_{GS}, Gate-to-source Voltage (V)
Figure 2. Transfer Characteristics

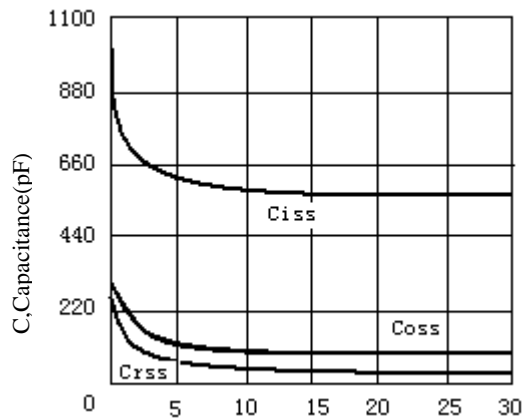

- V_{GS}, Drain-to Source Voltage
Figure 3. Capacitance

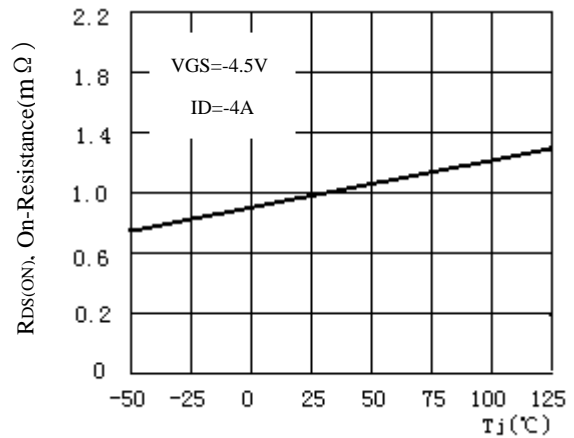
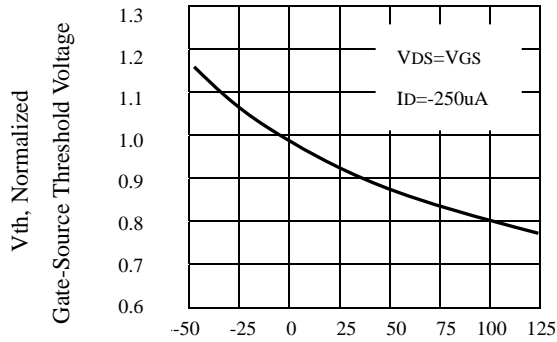
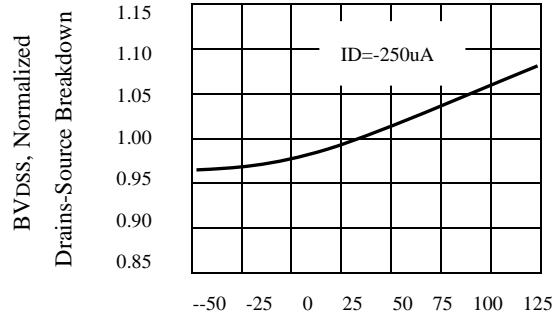

Figure 4. On-Resistance Variation with Temperature



Tj, Junction Temperature(°C)
Figure5.Gate Threshold Variation
With Temperature



Tj, Junction Temperature (°C)
Figure6.Breakdown Voltage Variation
With Temperature

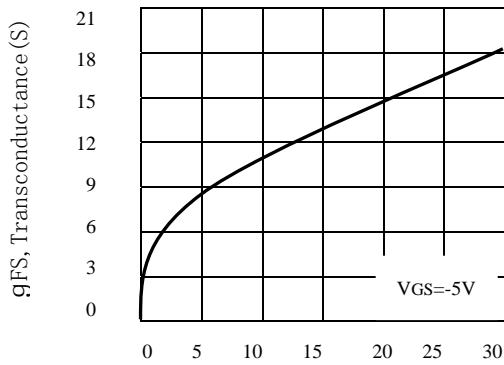

-IDS, Drain-Source Current (A)
Figure7.Transconductance Variation
With Drain Current

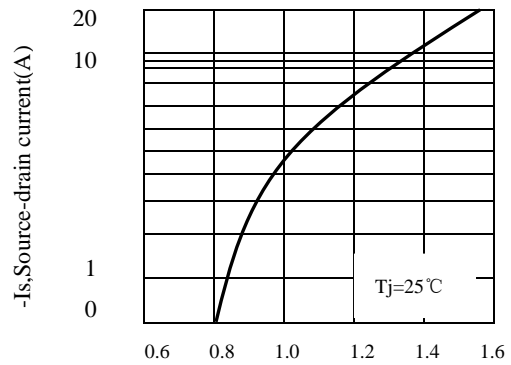

-VSD, Body Diode Forward Voltage
Figure8.Body Diode Forward Voltage
Variation with Source Current

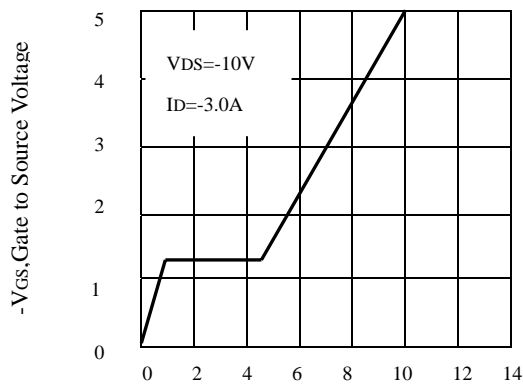

Qg, Total Gate Charge (nC)
Figure9. Gate Charge

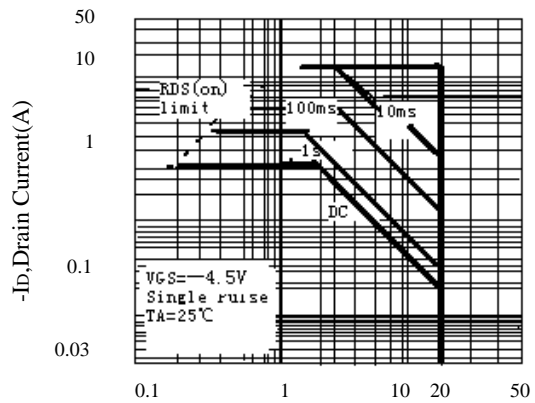

-VDS, Drain-Source Voltage(V)
Figure10.Maximum Safe Operating Area

SOT-23 Std Tape and Reel Data

SOT23-3L Packaging Configuration: Figure 1.0

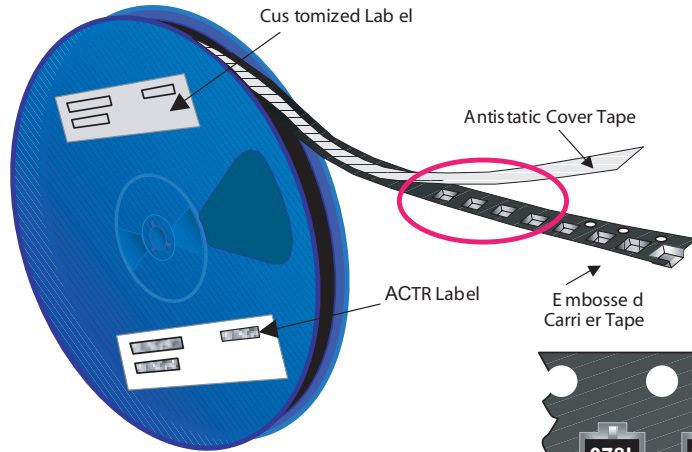

Packaging Description:

SOT23-3L parts are shipped in tape. The carrier tape is made from a dissipative (carbon filled) polycarbonate resin. The cover tape is a multilayer film (Heat Activated Adhesive in nature) primarily composed of polyester film, adhesive layer, sealant, and anti-static sprayed agent. These reeled parts in standard option are shipped with 3,000 units per 7" or 177mm diameter reel. The reels are dark blue in color and is made of polystyrene plastic (anti-static coated). Other option comes in 10,000 units per 13" or 330cm diameter reel. This and some other options are described in the Packaging Information table.

These full reels are individually labeled and placed inside a standard immediate box made of recyclable corrugated brown paper with a Faichild logo printing. One box contains five reels maximum. And these immediate boxes are placed inside a labeled shipping box which comes in different sizes depending on the number of parts shipped.

SOT23-3L Packaging Information		
Packaging Option	Standard (no flow code)	D87Z
Packaging type	TNR	TNR
Qty per Reel/Tube/Bag	3,000	10,000
Reel Size	7" Dia	13"
Box Dimension (mm)	193x183x80	355x333x40
Max qty per Box	15,000	30,000
Weight per unit (gm)	0.0082	0.0082
Weight per Reel (kg)	0.1175	0.4006
Note/Comments		

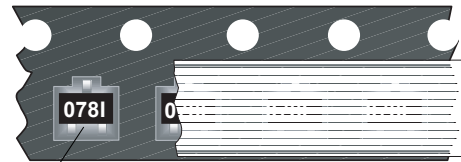

SOT23-3L Unit Orientation

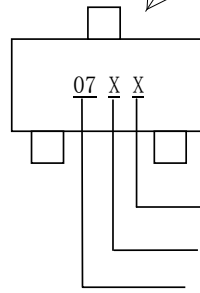

MARKING DIAGRAM

Barcode Label sample

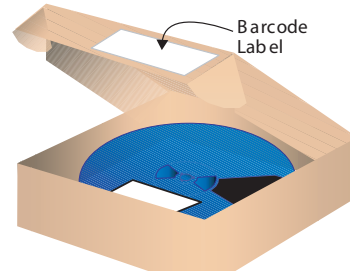
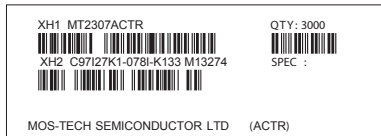

193mm x 183mm x 80mm
Pizza Box for Standard Option

SOT23-3L Tape Leader and Trailer Configuration: Figure 2.0

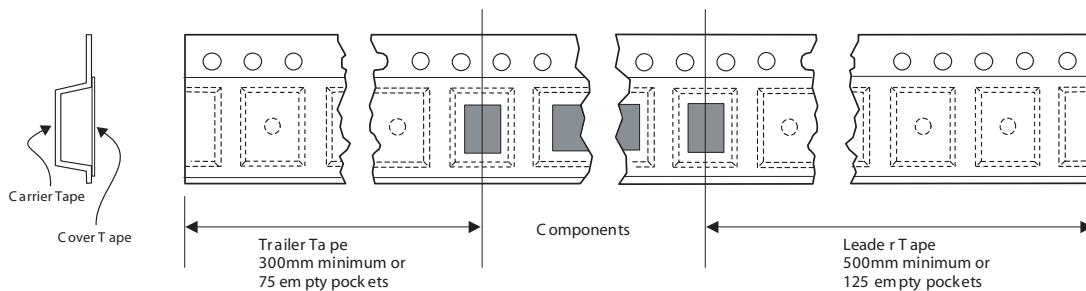

SOT-23 Std Tape and Reel Data, continued



SOT23-3L Embossed Carrier Tape Configuration: Figure 3.0

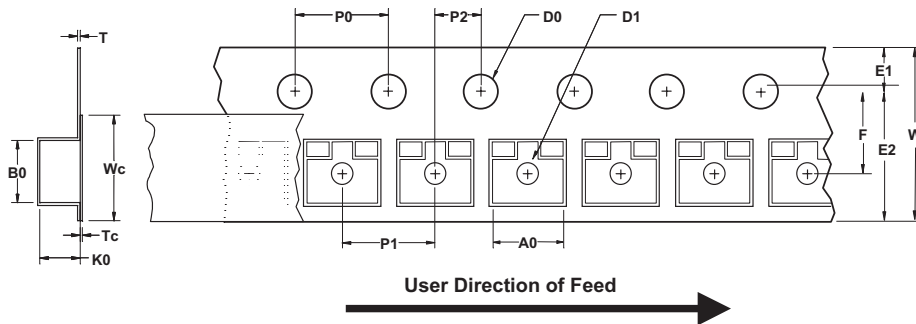

Dimensions are in millimeter														
Pkg type	A0	B0	W	D0	D1	E1	E2	F	P1	P0	K0	T	Wc	Tc
SOT-23 (8mm)	3.15 +/-0.10	2.77 +/-0.10	8.0 +/-0.3	1.55 +/-0.05	1.125 +/-0.125	1.75 +/-0.10	6.25 min	3.50 +/-0.05	4.0 +/-0.1	4.0 +/-0.1	1.30 +/-0.10	0.228 +/-0.013	5.2 +/-0.3	0.06 +/-0.02

Notes: A0, B0, and K0 dimensions are determined with respect to the EIA/Jedec RS-481 rotational and lateral movement requirements (see sketches A, B, and C).

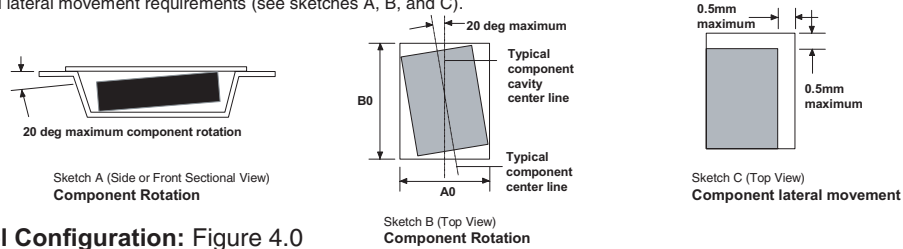

SOT23-3L Reel Configuration: Figure 4.0

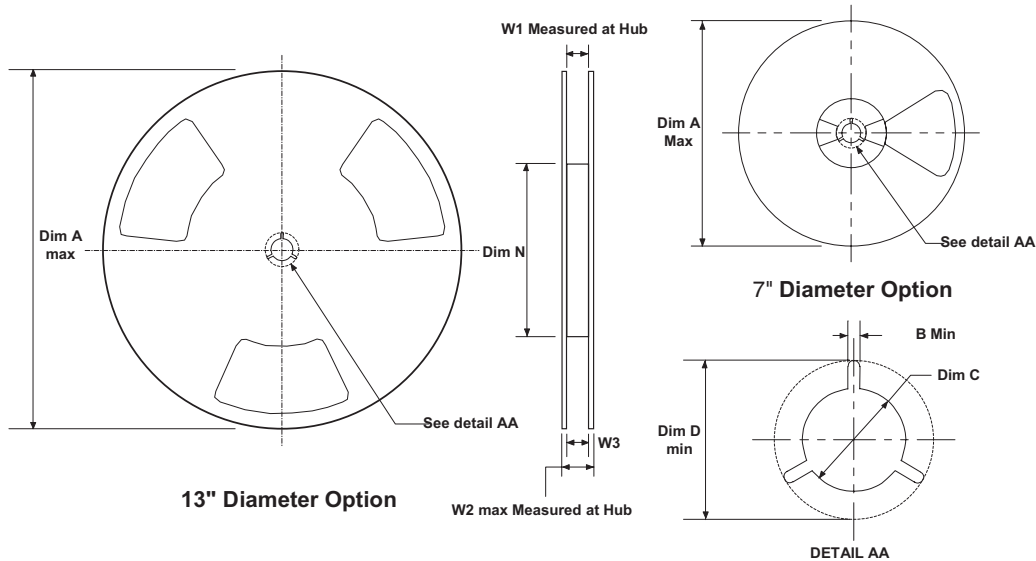

Dimensions are in inches and millimeters									
Tape Size	Reel Option	Dim A	Dim B	Dim C	Dim D	Dim N	Dim W1	Dim W2	Dim W3 (LSL-USL)
8mm	7" Dia	7.00 177.8	0.059 1.5	512 +0.020/-0.008 13 +0.5/-0.2	0.795 20.2	2.165 55	0.331 +0.059/-0.000 8.4 +1.5/0	0.567 14.4	0.311 - 0.429 7.9 - 10.9
8mm	13" Dia	13.00 330	0.059 1.5	512 +0.020/-0.008 13 +0.5/-0.2	0.795 20.2	4.00 100	0.331 +0.059/-0.000 8.4 +1.5/0	0.567 14.4	0.311 - 0.429 7.9 - 10.9



Notes regarding these materials

1. This document is provided for reference purposes only so that T [•] customers may select the appropriate T [•] products for their use. T [•] neither makes warranties or representations with respect to the accuracy or completeness of the information contained in this document nor grants any license to any intellectual property rights or any other rights of T [•] or any third party with respect to the information in this document.
2. T [•] shall have no liability for damages or infringement of any intellectual property or other rights arising out of the use of any information in this document, including, but not limited to, product data, diagrams, charts, programs, algorithms, and application circuit examples.
3. You should not use the products or the technology described in this document for the purpose of military applications such as the development of weapons of mass destruction or for the purpose of any other military use. When exporting the products or technology described herein, you should follow the applicable export control laws and regulations, and procedures required by such laws and regulations.
4. All information included in this document such as product data, diagrams, charts, programs, algorithms, and application circuit examples, is current as of the date this document is issued. Such information, however, is subject to change without any prior notice. Before purchasing or using any T [•] products listed in this document, please confirm the latest product information with a T [•] sales office. Also, please pay regular and careful attention to additional and different information to be disclosed by T [•] such as that disclosed through our website. (<http://www.tsmc.com>)
5. T [•] has used reasonable care in compiling the information included in this document, but T [•] assumes no liability whatsoever for any damages incurred as a result of errors or omissions in the information included in this document.
6. When using or otherwise relying on the information in this document, you should evaluate the information in light of the total system before deciding about the applicability of such information to the intended application. T [•] makes no representations, warranties or guaranties regarding the suitability of its products for any particular application and specifically disclaims any liability arising out of the application and use of the information in this document or T [•] products.
7. With the exception of products specified by T [•] as suitable for automobile applications, T [•] products are not designed, manufactured or tested for applications or otherwise in systems the failure or malfunction of which may cause a direct threat to human life or create a risk of human injury or which require especially high quality and reliability such as safety systems, or equipment or systems for transportation and traffic, healthcare, combustion control, aerospace and aeronautics, nuclear power, or undersea communication transmission. If you are considering the use of our products for such purposes, please contact a T [•] sales office beforehand. T [•] shall have no liability for damages arising out of the uses set forth above.
8. Notwithstanding the preceding paragraph, you should not use T [•] products for the purposes listed below:
 - (1) artificial life support devices or systems
 - (2) surgical implantations
 - (3) healthcare intervention (e.g., excision, administration of medication, etc.)
 - (4) any other purposes that pose a direct threat to human lifeT [•] shall have no liability for damages arising out of the uses set forth in the above and purchasers who elect to use T [•] products in any of the foregoing applications shall indemnify and hold harmless T [•] Technology Corp., its affiliated companies and their officers, directors, and employees against any and all damages arising out of such applications.
9. You should use the products described herein within the range specified by T [•] especially with respect to the maximum rating, operating supply voltage range, movement power voltage range, heat radiation characteristics, installation and other product characteristics. T [•] shall have no liability for malfunctions or damages arising out of the use of T [•] products beyond such specified ranges.
10. Although T [•] endeavors to improve the quality and reliability of its products, IC products have specific characteristics such as the occurrence of failure at a certain rate and malfunctions under certain use conditions. Please be sure to implement safety measures to guard against the possibility of physical injury, and injury or damage caused by fire in the event of the failure of a T [•] product, such as safety design for hardware and software including but not limited to redundancy, fire control and malfunction prevention, appropriate treatment for aging degradation or any other applicable measures. Among others, since the evaluation of microcomputer software alone is very difficult, please evaluate the safety of the final products or system manufactured by you.
11. In case T [•] products listed in this document are detached from the products to which the T [•] products are attached or affixed, the risk of accident such as swallowing by infants and small children is very high. You should implement safety measures so that T [•] products may not be easily detached from your products. T [•] shall have no liability for damages arising out of such detachment.
12. This document may not be reproduced or duplicated, in any form, in whole or in part, without prior written approval from T [•]
13. Please contact a T [•] sales office if you have any questions regarding the information contained in this document, T [•] semiconductor products, or if you have any other inquiries.



注意

本文只是参考译文，前页所载英文版“Cautions”具有正式效力。

关于利用本资料时的注意事项

1. 本资料是为了让用户根据用途选择合适的本公司产品的参考资料，对于本资料中所记载的技术信息，并非意味着对本公司或者第三者的知识产权及其他权利做出保证或对实施权力进行的承诺。
2. 对于因使用本资料所记载的产品数据、图、表、程序、算法及其他应用电路例而引起的损害或者对第三者的知识产权及其他权利造成侵犯，本公司不承担任何责任。
3. 不能将本资料所记载的产品和技术用于大规模破坏性武器的开发等目的、军事目的或其他的军需用途方面。另外，在出口时必须遵守中国的《外汇及外国贸易法》及其他出口的相关法令并履行这些法令中规定的必要手续。
4. 本资料所记载的产品数据、图、表、程序、算法以及其他应用电路例等所有信息均为本资料发行时的内容，本公司有可能在未做事先通知的情况下，对本资料所记载的产品或者产品规格进行更改。所以在购买和使用本公司的半导体产品之前，请事先向本公司的营业窗口确认最新的信息并经常留意本公司通过公司主页 (<http://www.mtsemi.com>) 等公开的最新信息。
5. 对于本资料中所记载的信息，制作时我们尽力保证出版时的精确性，但不承担因本资料的叙述不当而致使顾客遭受损失等的任何相关责任。
6. 在使用本资料所记载的产品数据、图、表等所示的技术内容、程序、算法及其他应用电路例时，不仅要对所使用的技术信息进行单独评价，还要对整个系统进行充分的评价。请顾客自行负责，进行是否适用的判断。本公司对于是否适用不负任何责任。
7. 本资料中所记载的产品并非针对万一出现故障或是错误运行就会威胁到人的生命或给人体带来危害的机器、系统(如各种安全装置或者运输交通用的、医疗、燃烧控制、航天器械、核能、海底中继用的机器和系统等)而设计和制造的,特别是对于品质和可靠性要求极高的机器和系统等(将本公司指定用于汽车方面的产品用于汽车时除外)。如果要用于上述的目的,请务必事先向本公司的营业窗口咨询。另外,对于用于上述目的而造成的损失等,本公司概不负责。
8. 除上述第7项内容外,不能将本资料中记载的产品用于以下用途。如果用于以下用途而造成的损失,本公司概不负责。
 - 1) 生命维持装置。
 - 2) 植埋于人体使用的装置。
 - 3) 用于治疗(切除患处、给药等)的装置。
 - 4) 其他直接影响到人的生命的装置。
9. 在使用本资料所记载的产品时,对于最大额定值、工作电源电压的范围、放热特性、安装条件及其他条件请在本公司规定的保证范围内使用。如果超出了本公司规定的保证范围使用时,对于由此而造成的故障和出现的事,本公司将不承担任何责任。
10. 本公司一直致力于提高产品的质量和可靠性,但一般来说,半导体产品总会以一定的概率发生故障、或者由于使用条件不同而出现错误运行等。为了避免因本公司的产品发生故障或者错误运行而导致人身事故和火灾或造成社会性的损失,希望客户能自行负责进行冗余设计、采取延烧对策及进行防止错误运行等的安全设计(包括硬件和软件两方面的设计)以及老化处理等,这是作为机器和系统的出厂保证。特别是单片机的软件,由于单独进行验证很困难,所以要求在顾客制造的最终的机器及系统上进行安全检验工作。
11. 如果把本资料所记载的产品从其载体设备上卸下,有可能造成婴儿误吞的危险。顾客在将本公司产品安装到顾客的设备上时,请顾客自行负责将本公司产品设置为不容易剥落的安全设计。如果从顾客的设备上剥落而造成事故时,本公司将不承担任何责任。
12. 在未得到本公司的事先书面认可时,不可将本资料的一部分或者全部转载或者复制。
13. 如果需要了解关于本资料的详细内容,或者有其他关心的问题,请向本公司的营业窗口咨询。

Keep safety first in your circuit designs!

1. MOS-TECH Semiconductor Corp. puts the maximum effort into making semiconductor products better and more reliable, but there is always the possibility that trouble may occur with them. Trouble with semiconductors may lead to personal injury, fire or property damage. Remember to give due consideration to safety when making your circuit designs, with appropriate measures such as (i) placement of substitutive, auxiliary circuits, (ii) use of nonflammable material or (iii) prevention against any malfunction or mishap.