

Features

- Combined PCM 30 framer, Line Interface Unit (LIU) and link controllers in a 68 pin PLCC or 100 pin MQFP package
- Selectable bit rate data link access with optional S_a bits HDLC controller (HDLC0) and channel 16 HDLC controller (HDLC1)
- Enhanced performance monitoring and programmable error insertion functions
- Low jitter DPLL for clock generation
- Operating under synchronized or free run mode
- Two-frame receive elastic buffer with controlled slip direction indication
- Selectable transmit or receive jitter attenuator
- Intel or Motorola non-multiplexed parallel microprocessor interface
- CRC-4 updating algorithm for intermediate path points of a message-based data link application
- ST-BUS/GCI 2.048 Mbit/s backplane bus for both data and signalling.

Applications

- E1 add/drop multiplexers and channel banks
- CO and PBX equipment interfaces
- Primary Rate ISDN nodes
- Digital Cross-connect Systems (DCS)

ISSUE 5

December 1997

Ordering Information

MT9075AP	68Pin PLCC
MT9075AL	100 Pin MQFP
-40°C to 85°C	

Description

The MT9075A is a single chip device which integrates an advanced PCM 30 framer with a Line Interface Unit (LIU).

The framer interfaces to a 2.048 Mbit/s backplane and provides selectable rate data link access with optional HDLC controllers for S_a bits and channel 16. The LIU interfaces the framer functions to the PCM 30 transformer-isolated four wire line.

The MT9075A meets or supports the latest ITU-T Recommendations including G.703, G.704, G.706, G.732, G.775, G.796, G.823 for PCM 30, and I.431 for ISDN primary rate. It also meets or supports ETSI ETS 300 166 and BS 6450.

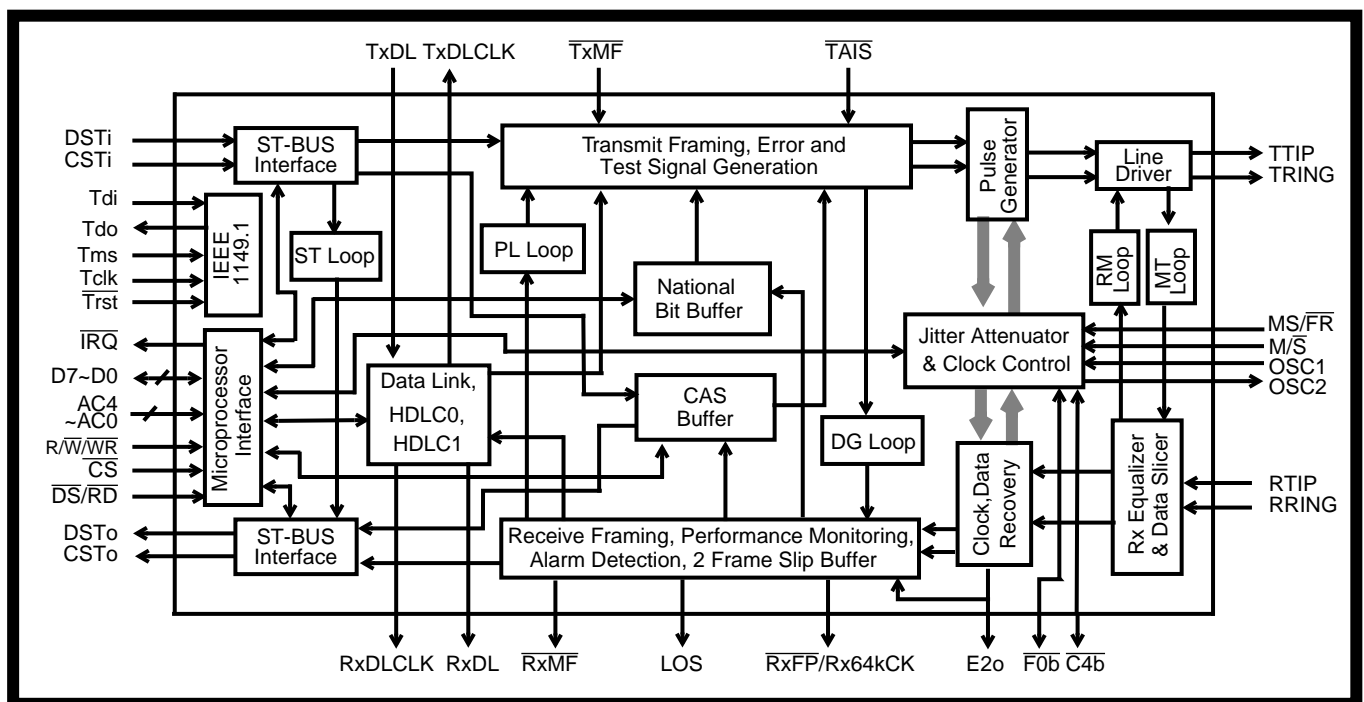
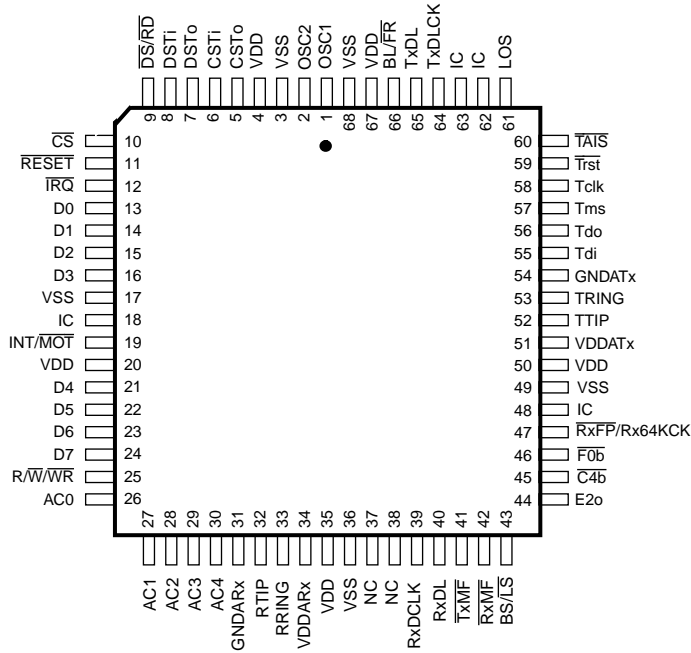
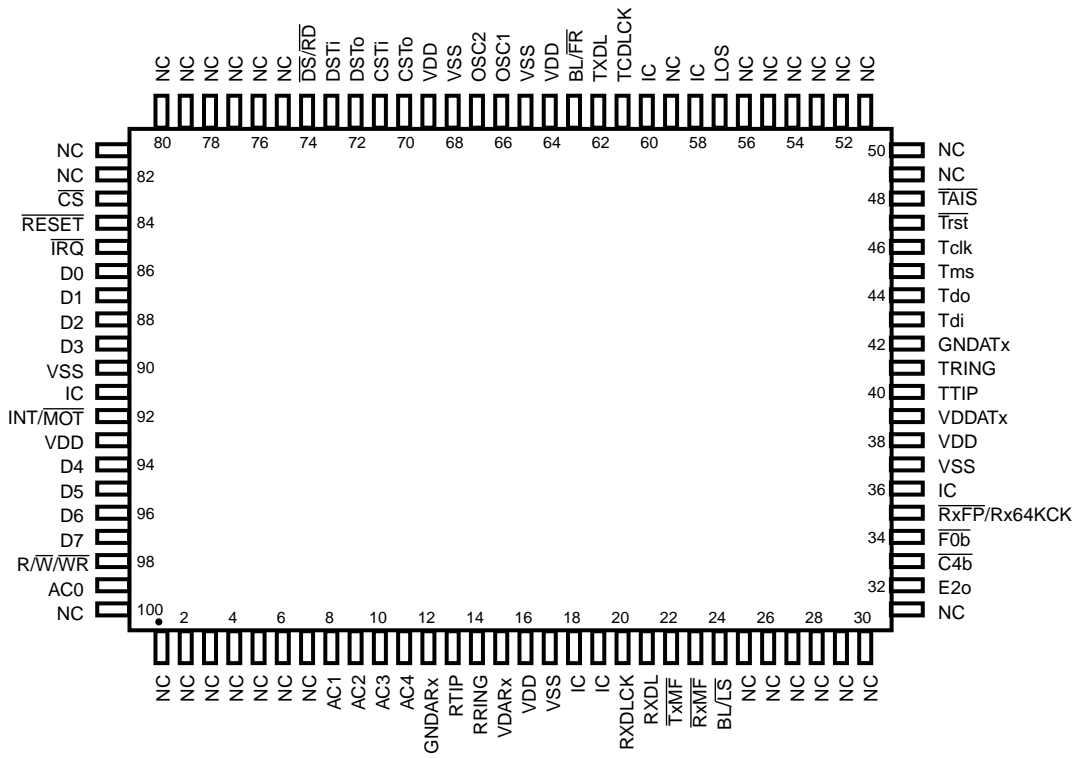

Figure 1 - Functional Block Diagram



68 PIN PLCC



100 PIN MQFP (JEDEC MO-112)

Figure 2 - Pin Connections

Pin Description

Pin #		Name	Description
PLCC	MQFP		
1	66	OSC1	Oscillator Input. This pin is either connected via a 20.000 MHz crystal to OSC2 where a crystal is used, or is directly driven when a 20.000 MHz oscillator is employed (see Figures 6 and 7). Not suitable for TTL compatible oscillator.
2	67	OSC2	Oscillator Output. Not suitable for driving other devices.
3	68	V_{SS}	Negative Power Supply (Input). Digital ground.
4	69	V_{DD}	Positive Power Supply (Input). Digital supply (+5V ± 5%).
5	70	CSTo	Control ST-BUS Output. CSTo carries one of the following two serial streams for CAS and CCS respectively: (i) A 2.048 Mbit/s ST-BUS status stream which contains the 30 receive signalling nibbles (ABCDZZZZ or ZZZZABCD). The most significant nibbles of each ST-BUS time slot are valid and the least significant nibbles of each ST-BUS time slot are tristated when control bit MSN (page 01H, address 1AH, bit 1) is set to 1. If MSN=0, the position of the valid and tristated nibbles is reversed. (ii) A 64 kb/s output when the 64 KHz common channel signalling option is selected (page 01H, address 1AH, bit 0, 64KCCS =1) for channel 16.
6	71	CSTi	Control ST-BUS Input. CSTi carries one of the following two serial streams for CAS and CCS respectively: (i) A 2.048 Mbit/s ST-BUS control stream which contains the 30 transmit signalling nibbles (ABCDXXXX or XXXXABCD) when page 01H, address 1AH, bit 3, RPSIG=0. When RPSIG=1 this pin has no function. The most significant nibbles of each ST-BUS time slot are valid and the least significant nibbles of each ST-BUS time slot are ignored when control bit MSN (page 01H, address 1AH, bit 1) is set to 1. If MSN=0, the position of the valid and ignored nibbles is reversed. (ii) A 64 kb/s input when the 64 KHz common channel signalling option is selected (page 01H, address 1AH, bit 0, 64KCCS =1) for channel 16.
7	72	DSTo	Data ST-BUS Output. A 2.048 Mbit/s serial stream which contains the 30 PCM or data channels received on the PCM 30 line.
8	73	DSTi	Data ST-BUS Input. A 2.048 Mbit/s serial stream which contains the 30 PCM or data channels to be transmitted on the PCM 30 line.
9	74	$\overline{DS/RD}$	Data/Read Strobe (Input). In Motorola mode (\overline{DS}), this input is the active low data strobe of the microprocessor interface. In Intel mode (\overline{RD}), this input is the active low read strobe of the microprocessor interface.
10	83	\overline{CS}	Chip Select (Input). This active low input enables the non-multiplexed parallel microprocessor interface of the MT9075A. When \overline{CS} is set to high, the microprocessor interface is idle and all bus I/O pins will be in a high impedance state.
11	84	\overline{RESET}	RESET (Input). This active low input puts the MT9075A in a reset condition. \overline{RESET} should be set to high for normal operation. The MT9075A should be reset after power-up. The \overline{RESET} pin must be held low for a minimum of 1μsec. to reset the device properly.
12	85	\overline{IRQ}	Interrupt Request (Output). A low on this output pin indicates that an interrupt request is presented. \overline{IRQ} is an open drain output that should be connected to V _{DD} through a pull-up resistor. An active low \overline{CS} signal is not required for this pin to function.
13 - 16	86- 89	D0 - D3	Data 0 to Data 3 (Three-state I/O). These signals combined with D4-D7 form the bidirectional data bus of the microprocessor interface (D0 is the least significant bit).

Pin Description (continued)

Pin #		Name	Description
PLCC	MQFP		
17	90	VSS	Negative Power Supply (Input). Digital ground.
18	91	IC	Internal Connection. Tie to V _{SS} (Ground) for normal operation.
19	92	INT/MOT	Intel/Motorola Mode Selection (Input). A high on this pin configures the processor interface for the Intel parallel non-multiplexed bus type. A low configures the processor interface for the Motorola parallel non-multiplexed type.
20	93	VDD	Positive Power Supply (Input). Digital supply (+5V ± 5%).
21 - 24	94-97	D4 - D7	Data 4 to Data 7 (Three-state I/O). These signals combined with D0-D3 form the bidirectional data bus of the microprocessor interface (D7 is the most significant bit).
25	98	R \overline{W} /WR	Read/Write/Write Strobe (Input). In Motorola mode (R \overline{W}), this input controls the direction of the data bus D[0:7] during a microprocessor access. When R \overline{W} is high, the parallel processor is reading data from the MT9075A. When low, the microprocessor is writing data to the MT9075A. For Intel mode (\overline{WR}), this active low write strobe configures the data bus lines as output.
26 - 30	99, 8-11	AC0 - AC4	Address/Control 0 to 4 (Inputs). Address and control inputs for the microprocessor interface. AC0 is the least significant input.
31	12	GNDARx	Receive Analog Ground (Input). Analog ground for the LIU receiver.
32 33	13 14	RTIP RRING	Receive TIP and RING (Inputs). Differential inputs for the receive line signal - must be transformer coupled (See Figure 4).
34	15	VDDARx	Receive Analog Power Supply (Input). Analog supply for the LIU receiver (+5V ± 5%).
35	16	VDD	Positive Power Supply (Input). Digital supply (+5V ± 5%).
36	17	VSS	Negative Power Supply (Input). Digital ground.
37	18	IC	Internal Connection. Must be left open for normal operation.
38	19	IC	Internal Connection. Must be left open for normal operation.
39	20	RxDLCLK	Receive Data Link Clock (Output). A gapped clock signal derived from a 2.048 Mbit/s clock, available for an external device to clock in RxDL data (at 4, 8, 12, 16 or 20 kHz) on the rising edge.
40	21	RxDL	Receive Data Link (Output). A 2.048 Mbit/s data stream containing received line data after HDB3 decoding. This data is clocked out with the rising edge of E2o.
41	22	TxMF	Transmit Multiframe Boundary (Input). An active low input used to set the transmit multiframe boundary (CAS or CRC multiframe). The MT9075A will generate its own multiframe if this pin is held high. This input is usually pulled high for most applications.
42	23	RxMF	Receive Multiframe Boundary (Output). An output pulse delimiting the received multiframe boundary. The next frame output on the data stream (DSTo) is basic frame zero on the PCM 30 link. This receive multiframe signal can be related to either the receive CRC multiframe (page 01H, address 10H, bit 6, MFSEL=1) or the receive signalling multiframe (MFSEL=0).
43	24	BS/LS	System Bus Synchronous/Line Synchronous Selection (Input). If high, $\overline{C4b}$ and $\overline{F0b}$ will be inputs; if low, $\overline{C4b}$ and $\overline{F0b}$ will be outputs.
44	32	E2o	2.048 MHz Extracted Clock (Output). The clock extracted from the received signal and used internally to clock in data received on RTIP and RRING.

Pin Description (continued)

Pin #		Name	Description
PLCC	MQFP		
45	33	$\overline{C4b}$	4.096 MHz System Clock (Input/Output). $\overline{C4b}$ is the clock for the ST-BUS sections and transmit serial PCM data of the MT9075A. In the free-run ($BL/\overline{FR}=0$) or line synchronous mode ($BL/\overline{FR}=1$ and $BS/\overline{LS}=0$) this signal is an output, while in the system bus synchronous mode ($BS/\overline{LS}=1$) this signal is an input clock.
46	34	$\overline{F0b}$	Frame Pulse (Input/Output). This is the ST-BUS or GCI frame synchronization signal, which delimits the 32 channel frame of CSTi, CSTo, DSTi, DSTo and the PCM30 link. In the free-run ($BL/\overline{FR}=0$) or loop synchronous mode ($BL/\overline{FR}=1$ and $BS/\overline{LS}=0$) this signal is an output, while in the Bus Synchronous mode ($BL/\overline{FR}=1$ and $BS/\overline{LS}=0$) this signal is an input. The GCI/ST-BUS selection is made under software control. Page 02H, address 13H, bit 0, $GCI/\overline{ST}=1$ selects GCI frame pulse; $GCI/\overline{ST}=0$ selects ST-BUS.
47	35	$\overline{RxFP}/$ $Rx64KCK$	Receive Frame Pulse/Receive CCS Clock (Output). An 8kHz pulse signal, which is low for one extracted clock period. This signal is synchronized to the receive PCM 30 basic frame boundary. When 64KCCS (page 01H, address 1AH, bit 0) is set to 1, this pin outputs a 64 kHz clock derived by dividing down the extracted 2.048 MHz clock. This clock is used to clock CCS data out of pin CSTo in the CCS mode.
48	36	IC	Internal Connection. Must be left open for normal operation.
49	37	V_{SS}	Negative Power Supply (Input). Digital ground.
50	38	V_{DD}	Positive Power Supply (Input). Digital supply (+5V \pm 5%).
51	39	V_{DDATx}	Transmit Analog Power Supply (Input). Analog supply for the LIU transmitter (+5V \pm 5%).
52	40	TTIP	Transmit TIP and RING (Outputs). Differential outputs for the transmit line signal - must be transformer coupled (See Figure 4).
53	41	TRING	
54	42	GND_{ATx}	Transmit Analog Ground (Input). Analog ground for the LIU transmitter.
55	43	Tdi	IEEE 1149.1 Test Data Input. If not used, this pin should be pulled high.
56	44	Tdo	IEEE 1149.1 Test Data Output. If not used, this pin should be left unconnected.
57	45	Tms	IEEE 1149.1 Test Mode Selection (Input). If not used, this pin should be pulled high.
58	46	Tclk	IEEE 1149.1 Test Clock Signal (Input). If not used, this pin should be pulled high.
59	47	\overline{Trst}	IEEE 1149.1 Reset Signal (Input). If not used, this pin should be held low.
60	48	\overline{TAIS}	Transmit Alarm Indication Signal (Input). An active low on this input causes the MT9075A to transmit an AIS (all ones signal) on TTIP and TRING pins. \overline{TAIS} should be set to high for normal data transmission.
61	57	LOS	Loss of Signal or Synchronization (Output). When high, and LOS/LOF (page 02H address 13H bit 2) is zero, this signal indicates that the receive portion of the MT9075A is either not detecting an incoming signal (bit LLOS on page 03H address 18H is one) or is detecting a loss of basic frame alignment condition (bit SYNC on page 03H address 10H is one). If LOS/LOF=1, a high on this pin indicates a loss of signal condition.
62	58	IC	Internal Connection. Tie to V_{SS} (Ground) for normal operation.
	59	NC	No Connection. Leave open for normal operation.
63	60	IC	Internal Connection. Tie to V_{SS} (Ground) for normal operation.

Pin Description (continued)

Pin #		Name	Description
PLCC	MQFP		
64	61	TxDLCLK	Transmit Data Link Clock (Output). A gapped clock signal derived from a gated 2.048 Mbit/s clock for transmit data link at 4, 8, 12, 16 or 20 kHz. The transmit data link data (TxDL) is clocked in on the rising edge of TxDLCLK. TxDLCLK can also be used to clock DL data out of an external serial controller.
65	62	TxDL	Transmit Data Link (Input). An input serial stream of transmit data link data at 4, 8, 12, 16 or 20 kbit/s composed of 488ns-wide bit cells which are multiplexed into selected national bits of the PCM 30 transmit signal.
66	63	BL/$\overline{\text{FR}}$	BusorLine/Freerun (Input). If this pin is set to high, the MT9075A is in the System Bus or Line Synchronous mode depending on the BS/ $\overline{\text{LS}}$ pin. If low, the MT9075A is in the free run mode.
67	64	VDD	Positive Power Supply (Input). Digital supply (+5V \pm 5%).
68	65	VSS	Negative Power Supply (Input). Digital ground.
	1-7, 25-31, 49-56, 75-82, 100	NC	No Connection. Leave open for normal operation.

Device Overview

The MT9075A is an advanced PCM 30 framer with an on-chip Line Interface Unit (LIU) that meets or supports the latest ITU-T Recommendations for PCM 30 and ISDN primary rate including G.703, G.704, G.706, G.775, G.796, G.732, G.823 and I.431. It also meets or supports the layer 1 requirements of ETSI ETS 300 166 and BS6450.

The Line Interface Unit (LIU) of the MT9075A interfaces the digital framer functions to the PCM 30 transformer-isolated four wire line. The transmit portion of the MT9075A LIU consists of a digital buffer, a digital-to-analog converter and a differential line driver. The receiver portion of the LIU consists of an input signal peak detector, an optional two-stage equalizer, a smoothing filter, data and clock slicers and a clock extractor. The optional equalizer allows for error free reception of data with a line attenuation of up to 20 dB.

The LIU also contains a Jitter Attenuator (JA), which can be configured to either the transmit or receive path. The JA will attenuate jitter from 2.5 Hz and roll-off at a rate of 20 dB/decade. Its intrinsic jitter is less than 0.02 UI.

The digital portion of the MT9075A connects an incoming stream of time multiplexed PCM channels (at 2.048 Mbit/s) to the transmit payload of the E1 trunk, while the receive payload is connected to the ST-BUS or GCI 2.048 Mbit/s backplane bus for both data and signalling. Control, reporting and conditioning of the line is implemented via a parallel microprocessor interface. The MT9075A framing algorithm allows automatic interworking between CRC-4 and non-CRC-4 interfaces.

The S_a bits can be accessed by the MT9075A in the following four ways:

- Single byte registers;
- Five byte transmit and receive national bit buffers;
- Data link pins TxDL, RxDL, RxDLCLK and TxDLCLK;
- HDLC Controller with a 128 byte FIFO.

The MT9075A operates in either termination or transparent modes selectable via software control. In the termination mode the CRC-4 calculation is performed as part of the framing algorithm. In the transmit transparent mode, no framing or signalling is imposed on the data transmit from DST_i on the line. In addition, the MT9075A optionally allows the

data link maintenance channel to be modified and updates the CRC-4 remainder bits to reflect the modification. All channel, framing and signalling data passes through the device unaltered. This is useful for intermediate point applications of a PCM 30 link where the data link data is modified, but the error information transported by the CRC-4 bits must be passed to the terminating end. In the receive transparent mode, the received line data is channelled to DST_o with framing operations disabled, consequently, the data passes through the slip buffer and drives DST_o with an arbitrary alignment.

The MT9075A has a comprehensive suite of status, alarm, performance monitoring and reporting features. These include counters for BPVs, CRC errors, E-bit errors, errored frame alignment signals, BERT, and RAI and continuous CRC errors. Also, included are transmission error insertion for BPVs, CRC-4 errors, frame and non-frame alignment signal errors, payload errors and loss of signal errors.

A complete set of loopback functions is provided, which includes digital, remote, ST-BUS, payload, metallic, local and remote time slot.

The MT9075A also contains a comprehensive set of maskable interrupts and an interrupt vector function. Interrupt sources consist of synchronization status, alarm status, counter indication and overflow, timer status, slip indication, maintenance functions and receive channel associated signalling bit changes. A special set of maskable interrupts have been included for sensing changes in the state of the national use bits and nibbles, in compliance to emerging ETS requirements.

The MT9075A system timing may be slaved to the line, operated in freerun mode, or controlled by an external timing source.

Functional Description

MT9075A Line Interface Unit (LIU)

Receiver

The receiver portion of the MT9075A LIU consists of an input signal peak detector, an optional two-stage equalizer, a smoothing filter, adaptive threshold comparators, data and clock slicers, and a clock extractor. Receive equalization gain can be set via software control or it can be determined automatically by the peak detectors.

The output of the receive equalizer is conditioned by a smoothing filter and is passed on to the clock and data slicer. The clock slicer output signal drives a phase locked loop, which generates the extracted clock (E2o). This extracted clock is used to sample the output of the data comparator.

The LOS output pin (pin 61 in PLCC, pin 57 in MQFP) is user selectable, by setting control bit LOS/LOF (page 02H, register 13H, bit 2), to indicate a loss of signal or loss of basic frame synchronization condition. In addition, a status bit, LLOS (bit 4 in page 3, register 18H) is provided to indicate the presence of a loss signal condition. The occurrence of a loss signal condition is defined as per I.431, i.e., when the incoming signal amplitude is more than 20 dB below the nominal amplitude for a time duration of at least 1 ms.

The receive LIU circuit requires a terminating resistor of either 120Ω or 75Ω across the device side of the receive1:1 transformer as shown in Figure 4. The return loss of the receiver, complying with G.703, is greater than:

- 12 dB from 51 kHz to 102 kHz;
- 18 dB from 102 kHz to 2048 kHz;
- 14 dB from 2048 kHz to 3072 kHz.

The jitter tolerance of the MT9075A clock extractor circuit exceeds the requirements of G.823 (Figure 3).

Transmitter

The MT9075A differential line driver is designed to drive a 1:2 step-up transformer (see Figure 4). In 120 Ω twisted pair applications, a 0.68 uF capacitor is required between the TTIP and the transmit transformer. For 75 Ω coaxial cable applications, a 0.68 uF capacitor and two 2.2 Ω series resistors are required between the transformer and the TTIP and TRING output pins as shown in Figure 4.

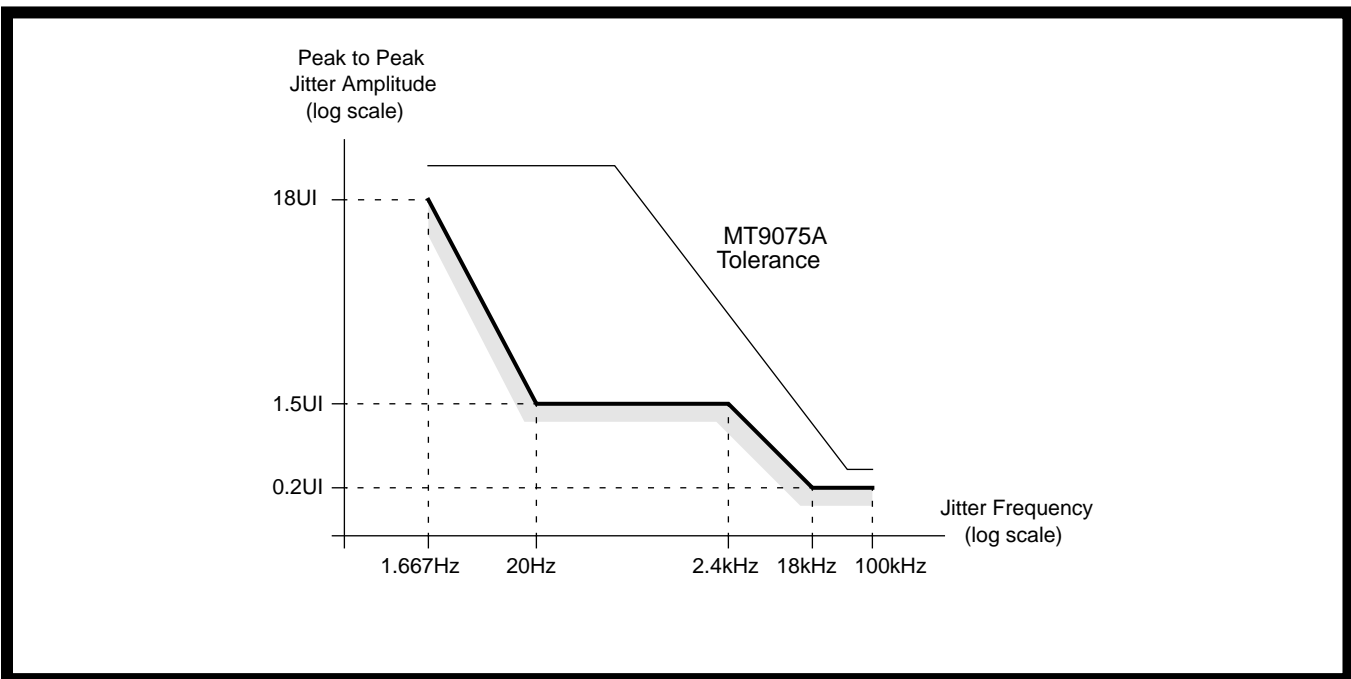

Figure 3 - Typical Jitter Tolerance

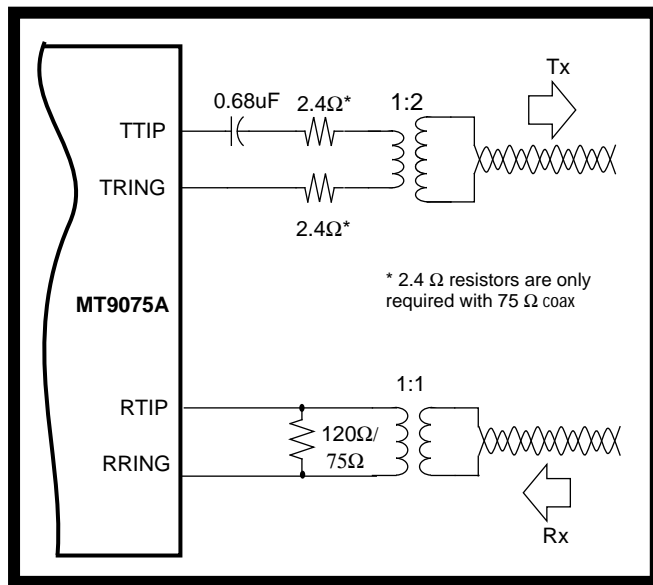

Figure 4 - Analog Line Interface

The template for the transmitted pulse, as specified in G703, is shown in Figure 5. The nominal peak voltage of a mark is 3 volts for 120 Ω twisted pair applications and 2.37 volts for 75 Ω coax applications. The ratio of the amplitude of the transmit pulses generated by TTP and TRING is between 0.95 and 1.05.

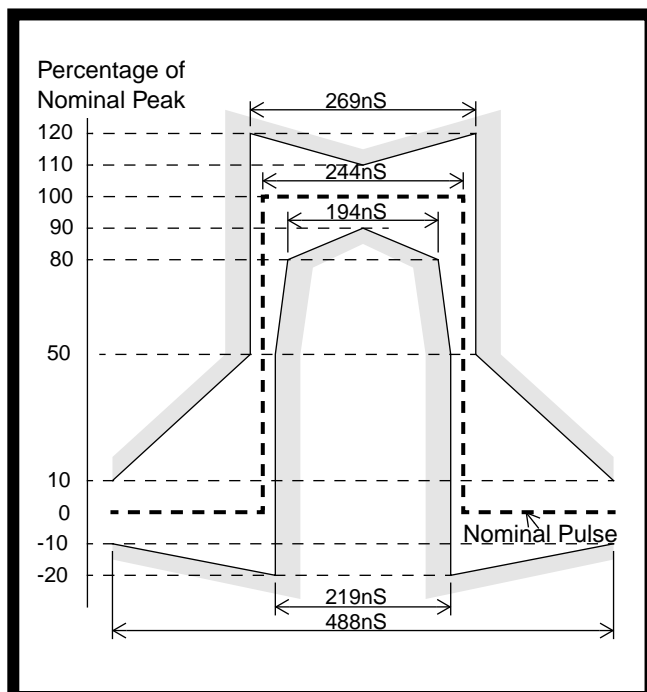

Figure 5 - Pulse Template (G.703)

Transformer Recommendation

Table 1 shows a list of recommended transformers for the MT9075A line interface.

Manufacturer	For Tx	For Rx
Filtran	5721-1	5721-2
Pulse Engineering	PE-65351	PE-64934
Midcom	50027	50026
OSEC	02934/A	02935/A

Table 1 - Transformer Manufacturers and Part Numbers

Timing Source

The MT9075A can use either a clock or crystal, connecting to pins OSC1 and OSC2, as the reference timing source.

Figure 6 shows a 20MHz clock oscillator, with 50ppm tolerance, directly connected to the OSC1 pin of the MT9075A.

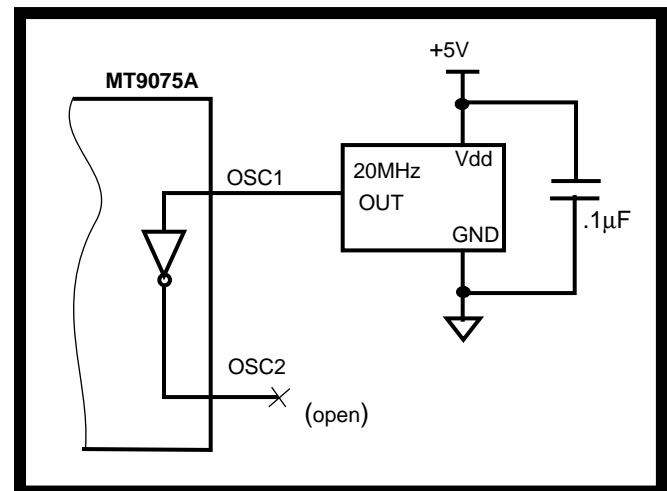

Figure 6 - Clock Oscillator Circuit

Alternatively, a crystal oscillator may be used. A complete oscillator circuit made up of a crystal, resistors and capacitors is shown in Figure 7. The crystal specification is as follows.

- Frequency: 20MHz
- Tolerance: 50ppm
- Oscillation Mode: Fundamental
- Resonance Mode: Parallel
- Load Capacitance: 32pF
- Maximum Series Resistance: 35Ω
- Approximate Drive Level: 1mW

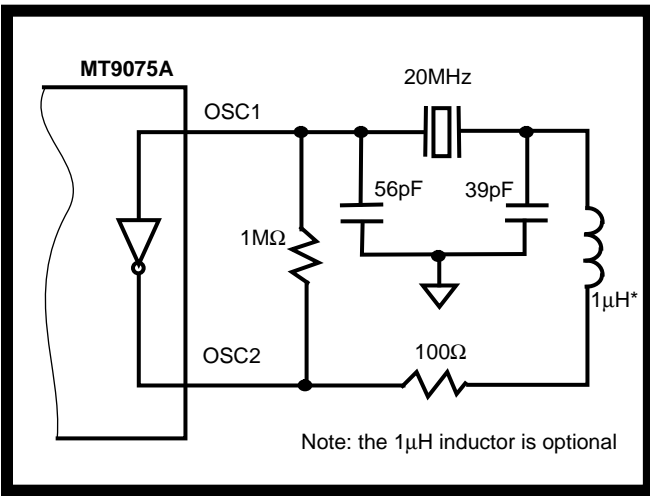

Figure 7 - Crystal Oscillator Circuit

Jitter Attenuator (JA)

The MT9075A Jitter Attenuator (JA), which consists of a Phase Locked Loop (PLL) and data FIFO, can be used on either the transmit or receive side of the interface.

On the transmit side the $\overline{C4b}$ signal clocks the data into the FIFO, the PLL de-jitters the $\overline{C4b}$ clock and the resulting clean $\overline{C4b}$ signal clocks the data out of the FIFO.

When the JA is selected on the receive side, the extracted clock signal clocks the data into the FIFO. The same clock feeds the PLL and the resulting de-

jittered clock is used to clock the data out of the FIFO.

The JA meets the jitter transfer characteristics as proposed by G.823 and the relevant recommendations as shown in Figure 8. The JA FIFO depth can be selected to be from 16 to 128 words deep, in multiples of 16 (2-bit) words. Its read pointer can be centered by changing the JFC bit (address 18H of page 02H) to provide maximum jitter tolerance. If the read pointer should come within 4 bits of either end of the FIFO, the read clock frequency will be increased or decreased by 0.0625 UI to correct the situation. The maximum time needed to centre is $T_{max} = 3904 * \text{Depth ns}$, where Depth is the selected JA FIFO depth. During this time the JA will not attenuate jitter.

To ensure normal operation, the JA FIFO depth should be set in software to be larger than the anticipated maximum UI of input jitter.

Clock Jitter Attenuation Modes

MT9075A has three basic jitter attenuation modes of operation, selected by the BS/ \overline{LS} and BL/ \overline{FR} control pins.

- System Bus Synchronous Mode.
- Line Synchronous Mode.
- Free-run mode.

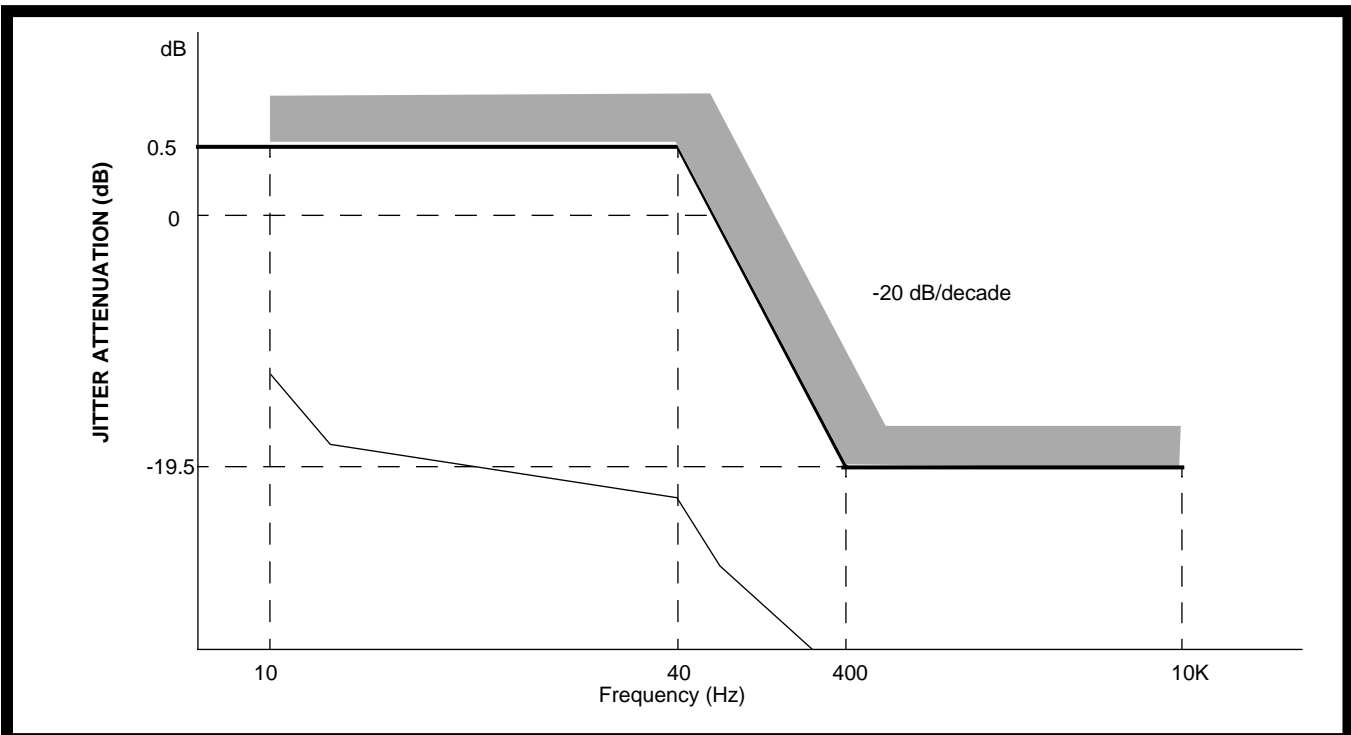

Figure 8 - Typical Jitter Attenuation Curve

Mode Name	BS/ \overline{LS}	BL/ \overline{FR}	JAS	JAT/ \overline{JAR}	Note
SysBusSync1	1	1	1	1	JA on Tx side; No JA on Rx side
SysBusSync2	1	1	1	0	JA on Rx side; No JA on Tx side
SysBusSync3	1	1	0	x	No JA on Tx or Rx side
Line Synchronous	0	1	x	x	By default, JA is on the receive side. Controls bits need not be selected.
Free-Run	x	0	x	x	In free-run mode JA will be automatically disconnected

Table 2 - Selection of Clock Jitter Attenuation Modes

Depending on the mode selected, the Jitter Attenuator (JA) can attenuate either transmit clock jitter or receive clock jitter, or be disconnected. Control bits JAS, JAT/ \overline{JAR} (address 18H of page 02H) determine the JA selection under certain modes. Table 2 shows the configuration of related control pins and control bits required to place the MT9075A in the appropriate jitter attenuation mode.

Referring to the mode names given in Table 2, the basic operation of the jitter attenuation modes is summarized as follows:

- In *SysBusSync* (1-3) modes, pins $\overline{C4b}$ and $\overline{F0b}$ are always configured as inputs, while in the Line Synchronous and Free-Run modes $\overline{C4b}$ and $\overline{F0b}$ are configured as outputs.
- In *SysBusSync1* mode, an external clock is applied to $\overline{C4b}$. The applied clock is dejittered by the internal PLL before being used to transmit data. The clock extracted (with no jitter attenuation performed) from the receive data can be monitored on pin E2o.
- In *SysBusSync2* mode, the clock applied to pin $\overline{C4b}$ is assumed to be jitter-free and is directly used to transmit data. The internal PLL is used to dejitter the extracted receive clock. The dejittered receive clock is output on pin E2o.
- In *SysBusSync3* mode, no jitter attenuation is applied to either the transmit or receive clocks. The transmit data is synchronized to clock applied to pin $\overline{C4b}$. The extracted receive clock is not dejittered and is supplied directly to the E2o output.
- In *Line Synchronous* mode, the clock extracted from the receive data is dejittered using the internal PLL and then output on pin $\overline{C4b}$. Pin E2o provides the extracted receive

clock before it has been dejittered. The transmit data is synchronous to the clean receive clock.

- In *Free-Run* mode the transmit data is synchronized to the internally generated clock. The internal clock is output on pin $\overline{C4b}$. The clock signal extracted from the receive data is not dejittered and is output directly on pin E2o.

The PCM 30 Interface

PCM 30 (E1) basic frames are 256 bits long and are transmitted at a frame repetition rate of 8000 Hz, which results in an aggregate bit rate of 256 bits x 8000/sec = 2.048 Mbits/sec. The actual bit rate is 2.048 Mbits/sec +/-50 ppm encoded in HDB3 format. The HDB3 control bit (page 01H, address 15H, bit 5) selects either HDB3 encoding or alternate mark inversion (AMI) encoding. Basic frames are divided into 32 time slots numbered 0 to 31, see Figure 31. Each time slot is 8 bits in length and is transmitted most significant bit first (numbered bit 1). This results in a single time slot data rate of 8 bits x 8000/sec. = 64 kbits/sec.

It should be noted that the Mitel ST-BUS also has 32 channels numbered 0 to 31, but the most significant bit of an eight bit channel is numbered bit 7 (see Mitel Application Note MSAN-126). Therefore, ST-BUS bit 7 is synonymous with PCM 30 bit 1; bit 6 with bit 2: and so on (Figure 31).

PCM 30 time slot 0 is reserved for basic frame alignment, CRC-4 multiframe alignment and the communication of maintenance information. In most configurations time slot 16 is reserved for either Channel Associated Signalling (CAS or ABCD bit signalling) or Common Channel Signalling (CCS). The remaining 30 time slots are called channels and carry either PCM encoded voice signals or digital

data. Channel alignment and bit numbering is consistent with time slot alignment and bit numbering. However, channels are numbered 1 to 30 and relate to time slots as per Table 3.

PCM 30 Timeslot	0	1 2 3...15	16	17 18 19...31
Voice/Data Channels	x	1 2 3...15	x	16 17 18...30

Table 3 - Time Slot to Channel Relationship

Basic Frame Alignment

Time slot 0 of every basic frame is reserved for basic frame alignment and contains either a Frame Alignment Signal (FAS) or a Non-Frame Alignment Signal (NFAS). FAS and NFAS occur in time slot zero of consecutive basic frames as shown in Table 7. Bit two is used to distinguish between FAS (bit two = 0) and NFAS (bit two = 1).

Basic frame alignment is initiated by a search for the bit sequence 0011011 which appears in the last seven bit positions of the FAS, see the Frame Algorithm section. Bit position one of the FAS can be either a CRC-4 remainder bit or an international usage bit.

Bits four to eight of the NFAS (i.e., $S_{a4} - S_{a8}$) are additional spare bits which may be used as follows:

- S_{a4} to S_{a8} may be used in specific point-to-point applications (e.g. transcoder equipments conforming to G.761).
- S_{a4} may be used as a message-based data link for operations, maintenance and performance monitoring.
- S_{a5} to S_{a8} are for national usage.

A maintenance channel or data link at 4,8,12,16, or 20 kHz for selected S_a bits is provided by the MT9075A to implement these functions. Note that for simplicity all S_a bits including S_{a4} are collectively called national bits throughout this document.

Bit three (designated as "A"), the Remote Alarm Indication (RAI), is used to indicate the near end basic frame synchronization status to the far end of a link. Under normal operation, the A (RAI) bit should be set to 0, while in alarm condition, it is set to 1.

Bit position one of the NFAS can be either a CRC-4 multiframe alignment signal, an E-bit or an international usage bit. Refer to an approvals laboratory and national standards bodies for specific requirements.

CRC-4 Multiframing

The primary purpose for CRC-4 multiframing is to provide a verification of the current basic frame alignment, although it can also be used for other functions such as bit error rate estimation. The CRC-4 multiframe consists of 16 basic frames numbered 0 to 15, and has a repetition rate of 16 frames X 125 microseconds/frame = 2 msec.

CRC-4 multiframe alignment is based on the 001011 bit sequence, which appears in bit position one of the first six NFASs of a CRC-4 multiframe.

The CRC-4 multiframe is divided into two submultiframes, numbered 1 and 2, which are each eight basic frames or 2048 bits in length.

The CRC-4 frame alignment verification functions as follows. Initially, the CRC-4 operation must be activated and CRC-4 multiframe alignment must be achieved at both ends of the link. At the local end of a link, all the bits of every transmit submultiframe are passed through a CRC-4 polynomial (multiplied by X^4 then divided by $X^4 + X + 1$), which generates a four bit remainder. This remainder is inserted in bit position one of the four FASs of the following submultiframe before it is transmitted (see Table 7).

The submultiframe is then transmitted and, at the far end, the same process occurs. That is, a CRC-4 remainder is generated for each received submultiframe. These bits are compared with the bits received in position one of the four FASs of the next received submultiframe. This process takes place in both directions of transmission.

When more than 914 CRC-4 errors (out of a possible 1000) are counted in a one second interval, the framing algorithm will force a search for a new basic frame alignment. See Frame Algorithm section for more details.

The result of the comparison of the received CRC-4 remainder with the locally generated remainder will be transported to the far end by the E-bits. Therefore, if $E_1 = 0$, a CRC-4 error was discovered in a submultiframe 1 received at the far end; and if $E_2 = 0$, a CRC-4 error was discovered in a submultiframe 2 received at the far end. No submultiframe sequence numbers or re-transmission capabilities are supported with layer 1 PCM 30 protocol. See ITU-T G.704 and G.706 for more details on the operation of CRC-4 and E-bits.

SYN \bar{C}	$\bar{C}RCSYN$	CRCIWK	Recommended Transmit RAI setting
0	0	1	Set transmit RAI continuously low.
0	0	0	This state cannot exist with $\bar{A}UTC$ set low.
1	1	x	Set transmit RAI continuously high.
0	1	1	Transmit a flickering (0 to 1 to 0) RAI every 8 milliseconds.
0	1	0	The link is a CRC to non CRC link. Set transmit RAI to the appropriate stable state (usually low).

Table 4 - Transmit RAI setting for CRC to non CRC interworking with AUTC set low

There are two CRC multiframe alignment algorithm options selected by the $\bar{A}UTC$ control bit (address 11H, page 01H). When $\bar{A}UTC$ is zero and $\bar{C}SYN$ is zero, automatic CRC-to-non-CRC interworking is selected, if CRC-4 multiframe alignment is not found in 400 msec, the status bit CRCIWK (page 03H, address 10H) is set low and no further attempt to achieve CRC-4 synchronization is made as long as the device remains in terminal frame synchronization. When $\bar{A}UTC$ is one and $\bar{C}SYN$ is zero, a reframe will be initiated every 8 msec if the MT9075A achieves terminal frame synchronization, but fails to achieve CRC-4 synchronization.

The control bit for transmit E bits (TE, bit 4 at address 16H of page 01H) will have the same function in both states of $\bar{A}UTC$. That is, when CRC-4 synchronization is not achieved the state of the transmit E-bits will be the same as the state of the TE control bit. When CRC-4 synchronization is achieved the transmit E-bits will function as per ITU-T G.704. Table 4 outlines the recommended setting of the TALM control bits of the MT9075A.

CAS Signalling Multiframing

The purpose of the signalling multiframing algorithm is to provide a scheme that will allow the association of a specific ABCD signalling nibble with the appropriate PCM 30 channel. Time slot 16 is reserved for the communication of Channel Associated Signalling (CAS) information (i.e., ABCD signalling bits for up to 30 channels). Refer to ITU-T G.704 and G.732 for more details on CAS multiframing requirements.

A CAS signalling multiframe consists of 16 basic frames (numbered 0 to 15), which results in a multiframe repetition rate of 2 msec. It should be noted that the boundaries of the signalling multiframe may be completely distinct from those of the CRC-4 multiframe. CAS multiframe alignment is based on a multiframe alignment signal (a 0000 bit sequence),

which occurs in the most significant nibble of time slot 16 of basic frame 0 of the CAS multiframe. Bit 6 of this time slot is the multiframe alarm bit (usually designated Y). When CAS multiframing is acquired on the receive side, the transmit Y-bit is zero; when CAS multiframing is not acquired, the transmit Y-bit is one. Bits 5, 7 and 8 (usually designated X) are spare bits and are normally set to one if not used.

Time slot 16 of the remaining 15 basic frames of the CAS multiframe (i.e., basic frames 1 to 15) are reserved for the ABCD signalling bits for the 30 payload channels. The most significant nibbles are reserved for channels 1 to 15 and the least significant nibbles are reserved for channels 16 to 30. That is, time slot 16 of basic frame 1 has ABCD for channel 1 and 16, time slot 16 of basic frame 2 has ABCD for channel 2 and 17, through to time slot 16 of basic frame 15 has ABCD for channel 15 and 30.

MT9075A Access and Control

Register Access

The control and status of the MT9075A is achieved through a non-multiplexed parallel microprocessor port. The parallel port may be configured for Motorola style control signals (by setting pin INT/ $\bar{M}OT$ low) or Intel style control signals (by setting pin INT/ $\bar{M}OT$ high).

The controlling microprocessor gains access to specific registers of the MT9075A through a two step process. First, writing to the internal Command/Address Register (CAR) selects one of the 18 pages of control and status registers (CAR address: AC4 = 0, AC3-AC0 = don't care, CAR data D7 - D0 = page number). Second, each page has a maximum of 16 registers that are addressed on a read or write to a non-CAR address (non-CAR: address AC4 = 1, AC3-AC0 = register address, D7-D0 = data). Once a page

of memory is selected, it is only necessary to write to the CAR when a different page is to be accessed. See Figures 11 and 12 for timing requirements.

Please note that for microprocessors with read/write cycles less than 200 ns, a wait state or a dummy operation (for C programming) between two successive read/write operations to the HDLC FIFO is required.

Table 5 associates the MT9075A control and status pages with access and page descriptions.

ST-BUS Streams

The ST-BUS stream can also be used to access channel associated signalling nibbles. CSTo contains the received channel associated signalling bits (e.g., ITU-T R1 and R2 signalling), and when control bit RPSIG (page 01H, address 1AH) is set to 0, CSTi is used to control the transmit channel associated signalling. The DSTi and DSTo streams contain the transmit and receive voice and digital data.

Identification Code

The MT9075A shall be identified by the code 10101010, read from the identification code status register (page 03H, address 1FH).

Reset Operation (Initialization)

The MT9075A can be reset using the hardware RESET pin (pin 11 in PLCC, pin 84 in MQFP, see pin description for external reset circuit requirements) or the software reset bit RST (page 01H, address 11H). When the device emerges from its reset state it will begin to function with the default settings described in Table 6. A reset operation takes 1 full frame (125 us) to complete.

Page Address D ₇ - D ₀	Register Description	Processor Access	ST-BUS Access
00000001 (01H)	Master Control	R/W	--
00000010 (02H)		R/W	
00000011 (03H)	Master Status	R	---
00000100 (04H)		R/W	
00000101 (05H)	Per Channel Transmit Signalling	R/W	CSTi
00000110 (06H)	Per Channel Receive Signalling	R	CSTo
00000111 (07H)	Per Time Slot Control	R/W	---
00001000 (08H)		R/W	
00001001 (09H)	1 Second Status	R	---
00001010 (0AH)	unused		---
00001011 (0BH)	HDLC0 Control and Status (TS 0)	R/W	---
00001100 (0CH)	HDLC1 Control and Status (TS 16)	R/W	---
00001101 (0DH)	Transmit National Bit Buffer	R/W	---
00001110 (0EH)	Receive National Bit Buffer	R	---
00001111 (0FH)	Tx message mode Buffer 0	R/W	---
00010000 (10H)	Tx message mode Buffer 1	R/W	---
00010001 (11H)	Rx message mode Buffer 0	R/W	---
00010010 (12H)	Rx message mode Buffer 1	R/W	---

Table 5 - Register Summary

Function	Status
Mode	Termination
Loopbacks	Deactivated
Transmit FAS	C _n 0011011
Transmit non-FAS	1/S _n 1111111
Transmit MFAS (CAS)	00001111
Data Link	Deactivated
CRC Interworking	Activated
Signalling	CAS Registers
ABCD Bit Debounce	Deactivated
Interrupts	Interrupt Mask Word Zero unmasked, all others masked; interrupts not suspended
RxMF Output	Signalling Multiframe
Error Insertion	Deactivated
HDLCs	Deactivated
Counters	Cleared
Tx Message Buffer	All locations set to 54H
Per Time Slot Control Buffer	All locations cleared

Table 6 - Reset Status

Transmit AIS Operation

The pin $\overline{\text{TAIS}}$ (Transmit AIS, pin 60 in PLCC, pin 48 in MQFP) allows an all ones signal to be transmitted from the point of power-up without the need to write any control registers. During this time the $\overline{\text{IRQ}}$ pin is tristated. After the interface has been initialized normal operation can take place by making $\overline{\text{TAIS}}$ high.

National Bit Buffers

Table 7 shows the contents of the transmit and receive Frame Alignment Signals (FAS) and Non-frame Alignment Signals (NFAS) of time slot zero of a PCM 30 signal. Even numbered frames (CRC Frame # 0, 2, 4,...) are FASs and odd numbered frames (CRC Frame # 1, 3, 5,...) are NFASs. The bits of each channel are numbered 1 to 8, with bit 1 being the most significant and bit 8 the least significant.

CRC	CRC Frame/Type	PCM 30 Channel Zero							
		1	2	3	4	5	6	7	8
Sub Multi Frame 1	0/FAS	C ₁	0	0	1	1	0	1	1
	1/NFAS	0	1	A	S _{a4}	S _{a5}	S _{a6}	S _{a7}	S _{a8}
	2/FAS	C ₂	0	0	1	1	0	1	1
	3/NFAS	0	1	A	S _{a4}	S _{a5}	S _{a6}	S _{a7}	S _{a8}
	4/FAS	C ₃	0	0	1	1	0	1	1
	5/NFAS	1	1	A	S _{a4}	S _{a5}	S _{a6}	S _{a7}	S _{a8}
	6/FAS	C ₄	0	0	1	1	0	1	1
Sub Multi Frame 2	7/NFAS	0	1	A	S _{a4}	S _{a5}	S _{a6}	S _{a7}	S _{a8}
	8/FAS	C ₁	0	0	1	1	0	1	1
	9/NFAS	1	1	A	S _{a4}	S _{a5}	S _{a6}	S _{a7}	S _{a8}
	10/FAS	C ₂	0	0	1	1	0	1	1
	11/NFAS	1	1	A	S _{a4}	S _{a5}	S _{a6}	S _{a7}	S _{a8}
	12/FAS	C ₃	0	0	1	1	0	1	1
	13/NFAS	E ₁	1	A	S _{a4}	S _{a5}	S _{a6}	S _{a7}	S _{a8}
	14/FAS	C ₄	0	0	1	1	0	1	1
	15/NFAS	E ₂	1	A	S _{a4}	S _{a5}	S _{a6}	S _{a7}	S _{a8}

Table 7 - FAS and NFAS Structure

 indicates position of CRC-4 multiframe alignment sign:

Table 8 illustrates the organization of the MT9075A transmit and receive national bit buffers. Each row is an addressable byte of the MT9075A national bit buffer, and each column contains the national bits of an odd numbered frame of each CRC-4 Multiframe. The transmit and receive national bit buffers are located at page 0DH and 0EH respectively.

Addressable Bytes	Frames 1, 3, 5, 7, 9, 11, 13 & 15 of a CRC-4 Multiframe							
	F1	F3	F5	F7	F9	F11	F13	F15
NBB0	S _{a4}	S _{a4}	S _{a4}	S _{a4}	S _{a4}	S _{a4}	S _{a4}	S _{a4}
NBB1	S _{a5}	S _{a5}	S _{a5}	S _{a5}	S _{a5}	S _{a5}	S _{a5}	S _{a5}
NBB2	S _{a6}	S _{a6}	S _{a6}	S _{a6}	S _{a6}	S _{a6}	S _{a6}	S _{a6}
NBB3	S _{a7}	S _{a7}	S _{a7}	S _{a7}	S _{a7}	S _{a7}	S _{a7}	S _{a7}
NBB4	S _{a8}	S _{a8}	S _{a8}	S _{a8}	S _{a8}	S _{a8}	S _{a8}	S _{a8}

Table 8 - MT9075A National Bit Buffers

Note that the Data Link (DL) pin functions, if selected, override the transmit national bit buffer function.

The CRC-4 Alignment status CALN (page 03H, address 12H) and maskable interrupt CALNI (page 01H, address 1DH) indicate the beginning of every received CRC-4 multiframe.

Maskable interrupts are available for change of state of S_{a5} bits or change of state of S_{a6} nibbles. By writing the proper control bits, an interrupt can be generated on a change of state of any S_a bit (except S_{a4} - normally reserved for the data link), or any nibbles for S_{a5} through S_{a8} . See the description of page 01H, address 19H for more details.

In addition, the transparent transmission of channel 0 is supported to meet the ETS requirement. Selectable on a bit by bit basis, S_a bits in channel 0 DSTi data can be programmed using register 17H of page 01H to be sent transparently onto the line.

Data Link Operation

Timeslot 0

The MT9075A has a user defined 4, 8, 12, 16 or 20 kbit/s data link for transport of maintenance and performance monitoring information across the PCM 30 link. This channel functions using the S_a bits (S_{a4} - S_{a8}) of the PCM 30 timeslot zero non-frame alignment signal (NFAS). Since the NFAS is transmitted every other frame - a periodicity of 250 microseconds - the aggregate bit rate is a multiple of 4 kb/s. As there are five S_a bits independently available for this data link, the bit rate will be 4, 8, 12, 16 or 20 kb/s, depending on the bits selected for the Data Link (DL).

The S_a bits used for the DL are selected by setting the appropriate bits, S_{a4} - S_{a8} , to one in the Data Link Select Word (page 01H, address 10H, bits 4-0). Access to the DL is provided by pins TxDLCLK, TxDL, RxDLCLK and RxDL, which allow easy interfacing to an external controller.

Data to be transmit onto the line in the S_a bit position is clocked in from the TxDL pad (pin 65 in PLCC, pin 62 in MQFP) with the clock TxDLCLK (pin 64 in PLCC, pin 61 in MQFP). Although the aggregate clock rate equals the bit rate, it has a nominal pulse width of 244 ns, and it clocks in the TxDL as if it were a 2.048 Mb/s data stream. The clock can only be active during bit times 4 to 0 of the STBUS frame. The TxDL input signal is clocked into the MT9075A by the rising edge of TxDLCLK. If bits are selected to be a part of the DL, all other programmed functions for those S_a bit positions are overridden.

The RxDLCLK signal (pin 39 in PLCC, pin 20 in MQFP) is derived from the receive extracted clock and is aligned with the receive data link output RxDL. The HDB3 decoded receive data, at 2.048 Mbit/s, is clocked out of the device on pin RxDL (pin 40 in PLCC, pin 21 in MQFP). In order to facilitate the attachment of this data stream to a Data Link controller, the clock signal RxDLCLK consists of positive pulses, of nominal width of 244 ns, during the S_a bit cell times that are selected for the data link. Again, this selection is made by programming address 10H of master control page 01H. No DL data will be lost or repeated when a receive frame slip occurs. See Figures 13-16 for timing requirements.

Timeslot 16

Channel 16 may be used to create a transparent 64 kb/s clear channel. In this event CSTi (pin 6 in PLCC, pin 71 in MQFP) becomes the data input pin for channel 16 transmit data, and CSTo (pin 5 in PLCC, pin 70 in MQFP) becomes a 64 kb/s serial output link. The CSTo output link is synchronous to the extracted clock timebase. The pin Rx64KCK (pin 47 in PLCC, pin 35 in MQFP) provides a 64 kHz clock for use with 64 kb/s data emanating from CSTo. The 64 kb/s input data from CSTi is clocked in with an internal 64 kHz clock synchronous to the I/O pin $\bar{C}4b$ (pin 45 in PLCC, pin 33 in MQFP) timebase. The internal clock toggles coincident with every second ST-BUS channel boundary, with the first rising edge of a frame occurring at the beginning of ST-BUS channel 2.

Dual HDLC

The MT9075A has two identical HDLC controllers (HDLC0, HDLC1) for the S_a bits and channel 16 respectively. The following features are common to both HDLC controllers:

- Independent transmit and receive FIFO's;
- Receive FIFO maskable interrupts for nearly full (programmable interrupt levels) and overflow conditions;
- Transmit FIFO maskable interrupts for nearly empty (programmable interrupt levels) and underflow conditions;
- Maskable interrupts for transmit end-of-packet and receive end-of-packet;
- Maskable interrupts for receive bad-frame (includes frame abort);
- Transmit end-of-packet and frame-abort functions.

HDLC0 Functions

When connected to the Data Link (DL) HDLC0 will operate at a selected bit rate of 4, 8, 12, 16 or 20 kbits/sec. HDLC0 can be selected by setting the control bit HDLC0 (bit 7) to one in page 01H, address 14H. When this bit is zero all interrupts from HDLC0 are masked. For more information refer to following sections.

HDLC1 Functions

This controller may be connected to time slot 16 under Common Channel Signalling (CCS) mode. It should be noted that the AIS16S function (page 03H, address 19H) will always be active and the TAIS16 function (page 01H, address 16H) will override all other transmit signalling.

HDLC1 can be selected by setting the control bit HDLC1 (bit 6) to one in page 01H, address 14H. When this bit is zero all interrupts from HDLC1 are masked.

HDLC Overview

The HDLC handles the bit oriented packetized data transmission as per X.25 level two protocol defined by CCITT. It provides flag and abort sequence generation and detection, zero insertion and deletion, and Frame Check Sequence (FCS) generation and detection. A single byte, dual byte and all call address in the received frame can be recognized. Access to the receive FCS and inhibiting of transmit FCS for terminal adaptation are also provided. Each HDLC controller has a 128 byte deep FIFO associated with it. The status and interrupt flags are programmable for FIFO depths that can vary from 16 to 128 bytes in steps of 16 bytes. These and other features are enabled through the HDLC control registers on page 0BH and 0CH.

HDLC Frame Structure

A valid HDLC frame (also referred as “packet”) begins with an opening flag, contains at least 16 bits of data field, and ends with a 16 bit FCS followed by a closing flag (Table 9).

All HDLC frames start and end with a unique flag sequence “01111110₂” (7EH). The transmitter generates these flags and appends them to the packet to be transmitted. The receiver searches the incoming data stream for the flags on a bit-by-bit basis to establish frame synchronization.

Opening Flag (7EH)	Data Field	FCS	Closing Flag (7EH)
One Byte 01111110	n Bytes $n \geq 2$	Two Bytes	One Byte 01111110

Table 9 - HDLC Frame Format

The data field usually consists of an address field, control field and information field. The address field consists of one or two bytes directly following the opening flag. The control field consists of one byte directly following the address field. The information field immediately follows the control field and consists of n bytes of data. The HDLC does not distinguish between the control and information fields and a packet does not need to contain an information field to be valid.

The FCS field, which precedes the closing flag, consists of two bytes. A cyclic redundancy check utilizing the CCITT standard polynomial “ $X^{16}+X^{12}+X^5+1$ ” produces the 16-bit FCS. In the transmitter the FCS is calculated on all bits of the address and data field. The complement of the FCS is transmitted, most significant bit first, in the FCS field. The receiver calculates the FCS on the incoming packet address, data and FCS field and compares the result to “F0B8”. If no transmission errors are detected and the packet between the flags is at least 32 bits in length then the address and data are entered into the receive FIFO minus the FCS which is discarded.

Data Transparency (Zero Insertion/Deletion)

Transparency ensures that the contents of a data packet do not imitate a flag, go-ahead, frame abort or idle channel. The contents of a transmitted frame, between the flags, is examined on a bit-by-bit basis and a 0 is inserted after all sequences of 5 contiguous 1s (including the last five bits of the FCS). Upon receiving five contiguous 1s within a frame the receiver deletes the following 0.

Invalid Frames

A frame is invalid if one of the following four conditions exists:

- If the FCS pattern generated from the received data does not match the “F0B8” pattern then the last data byte of the packet is written to the received FIFO with a ‘bad packet’ indication.

- A short frame exists if there are less than 25 bits between the flags. Short frames are ignored by the receiver and nothing is written to the receive FIFO.
- Packets which are at least 25 bits in length but less than 32 bits between the flags are also invalid. In this case the data is written to the FIFO but the last byte is tagged with a "bad packet" indication.
- If a frame abort sequence is detected the packet is invalid. Some or all of the current packet will reside in the receive FIFO, assuming the packet length before the abort sequence was at least 26 bits long.

Frame Abort

The transmitter will abort a current packet by substituting a zero followed by seven contiguous 1s in place of the normal packet. The receiver will abort upon reception of seven contiguous 1s occurring between the flags of a packet which contains at least 26 bits.

Note that should the last received byte before the frame abort end with contiguous 1s, these are included in the seven 1s required for a receiver abort. This means that the location of the abort sequence in the receiver may occur before the location of the abort sequence in the originally transmitted packet. If this happens then the last data written to the receive FIFO will not correspond exactly with the last byte sent before the frame abort.

Interframe Time Fill and Link Channel States

When the HDLC transmitter is not sending packets it will wait in one of two states

- Interframe Time Fill state: This is a continuous series of flags occurring between frames indicating that the channel is active but that no data is being sent.
- Idle state: An idle Channel occurs when at least 15 contiguous 1s are transmitted or received.

In both states the transmitter will exit the wait state when data is loaded into the transmitter FIFO.

Go-Ahead

A go-ahead is defined by a 9 bit sequence "011111110" (contiguous 7Fs) and hence is the occurrence of a frame abort sequence followed by a zero. This feature is used to distinguish a proper in-packet frame abort sequence from one occurring outside of a packet for some special applications

HDLC Functional Description

The HDLC controller can be reset by either the reset pin ($\overline{\text{RESET}}$, pin 11 in PLCC or pin 84 in MQFP) or by the control bit HRST at address 1BH in page 0BH (for HDLC0) or page 0CH (for HDLC1). When reset, the HDLC Control Registers are cleared, resulting in the transmitter and receiver being disabled. The receiver and transmitter can be enabled independent of each other through Control Register 1 at address 13H. The transceiver input and output are enabled when the enable control bits in Control Register 1 are set. Transmit to receive loopback as well as a receive to transmit loopback are also supported. Transmit and receive bit rates and enables can operate independently.

Received packets from the serial interface are sectioned into bytes by an HDLC receiver that detects flags, checks for go-ahead signals, removes inserted zeros, performs a cyclical redundancy check (CRC) on incoming data, and monitors the address if required. Packet reception begins upon detection of an opening flag. The resulting bytes are concatenated with two status bits (RQ9 and RQ8 at address 14H) and placed in a receiver first-in-first-out buffer (RX FIFO). Register 14H also contains control bits that generate status and interrupts for microprocessor read control.

In conjunction with the control circuitry, the microprocessor writes data bytes into a transmit buffer (TX FIFO) register that generates status and interrupts. Packet transmission begins when the microprocessor writes a byte to the TX FIFO. Two status bits are added to the TX FIFO for transmitter control of frame aborts (FA) and end of packet (EOP) flags. Packets have flags appended, zeros inserted, and an FCS, added automatically during serial transmission. When the TX FIFO is empty and finished sending a packet, Interframe Time Fill bytes (continuous flags (7E hex)), or Mark Idle (continuous ones) are transmitted to indicate that the channel is idle.

HDLC Transmitter

Following initialization and enabling, the transmitter is in the Idle Channel state (Mark Idle), continuously sending ones. Interframe Time Fill state (Flag Idle) is selected by setting the Mark Idle bit in Control Register 1 to one. The transmitter remains in either of these two states until data is written to the TX FIFO. Control Register 1 bits EOP (End Of Packet) and FA (Frame Abort) are set as status bits before the microprocessor loads 8 bits of data into the 10 bit wide FIFO (8 bits data and 2 bits status). To change

the tag bits being loaded in the FIFO, Control Register 1 must be written to before writing to the FIFO. However, EOP and FA are reset after writing to the TX FIFO. The Transmit Byte Count Register may also be used to tag an EOP. The register is loaded with the number of bytes in the packet and decrements after every write to the Tx FIFO. When a count of one is reached, the next byte written to the FIFO is tagged as an end of packet. The register may be made to cycle through the same count if the packets are of the same length by setting Control Register 2, bit Cycle (at address 15H of page 0BH for HDLC0 or 0CH for HDLC1).

If the transmitter is in the Idle Channel state when data is written to the TX FIFO, then an opening flag is sent and data from TX FIFO follows. Otherwise, data bytes are transmitted as soon as the current flag byte has been sent. TX FIFO data bytes are continuously transmitted until either the FIFO is empty or an EOP or FA status bit is read by the transmitter. After the last bit of the EOP byte has been transmitted, a 16-bit FCS is sent followed by a closing flag. When multiple packets of data are loaded into TX FIFO, only one flag is sent between packets.

Frame Aborts (FA, the transmission of 7F hex), are transmitted by tagging a byte previously written to the TX FIFO. When a byte has an FA tag, then an FA is sent instead of that tagged byte. That is, all bytes previous to but not including that byte are sent. After an FA, the transmitter returns to the Mark Idle or Interframe Time Fill state, depending on the state of the Mark idle control bit.

TX FIFO underrun will occur if the FIFO empties and the last byte did not have either an EOP or FA tag. A frame abort sequence will be sent when an underrun occurs.

Below is an example of the transmission of a three byte packet ('AA'03'77' hex) (Interframe time fill). TxEN can be enabled before or after this sequence.

- (a) Write'04' to Control Register 1 - Mark Idle bit set
- (b) Write'AA' to Tx FIFO -Data byte
- (c) Write'03' to Tx FIFO - Data byte
- (d) Write'34' to Control Register 1 - TxEN; EOP; Mark Idle bits set
- (e) Write'77' to Tx FIFO - Final data byte

The transmitter may be enabled independently of the receiver. This is done by setting the TxEN bit of the Control Register. Enabling happens immediately upon writing to the register. Disabling using TxEN will occur after the completion of the transmission of the present packet; the contents of the FIFO are not

cleared. Disabling will consist of stopping the transmitter clock. The Status and Interrupt Registers may still be read, and the FIFO and Control Registers may be written to while the transmitter is disabled. The transmitted FCS may be inhibited using the Tcrcl bit of Control Register 2. In this mode the opening flag followed by the data and closing flag is sent and zero insertion is still included, but no FCS. That is, the FCS is injected by the microprocessor as part of the data field. This is used in V.120 terminal adaptation for synchronous protocol sensitive UI frames.

HDLC Receiver

After initialization and enabling, the receiver clocks in serial data, continuously checking for Go-Aheads (0 1111 1110), flags (0111 1110), and Idle Channel states (at least fifteen ones). When a flag is detected, the receiver synchronizes itself to the serial stream of data bits, automatically calculating the FCS. If the data length between flags after zero removal is less than 25 bits, then the packet is ignored so no bytes are loaded into Rx FIFO. When the data length after zero removal is between 25 and 31 bits, a first byte and bad FCS code are loaded into the Rx FIFO. For an error-free packet, the result in the CRC register should match the HEX pattern of "F0B8" when a closing flag is detected.

If address recognition is required, the Receiver Address Recognition Registers (address 10H and 11H) are loaded with the desired address and the Adrec bit in the Control Register 1 (address 13H) is set to one. Bit 0 of the Address Registers is used as an enable bit for that byte, thus allowing either or both of the first two bytes to be compared to the expected values. In addition, seven bits of address comparison can be realized on the first byte if this is a single byte address by setting the *Seven* bit of Control Register 2 (address 15H).

Two Status Register bits (RQ8 and RQ9) are appended to each data byte as it is written to the Rx FIFO. They indicate that a good packet has been received (good FCS and no frame abort), or a bad packet with either incorrect FCS or frame abort. The Status and Interrupt Registers should be read before reading the Rx FIFO since status and interrupt information correspond to the byte at the output of the FIFO (i.e., the byte about to be read). The Status Register bits are encoded as follows:

<u>RQ9</u>	<u>RQ8</u>	<u>Byte status</u>
1	1	last byte (bad packet)
0	1	bad packet
1	0	last byte (good packet)
0	0	packet byte

The end-of-packet-detect (EOPD) interrupt indicates that the last byte written to the RX FIFO was an EOP byte. The end-of-packet-read (EOPR) interrupt indicates that the byte about to be read from the RX FIFO is an EOP byte. The Status Register should be read to see if the packet is good or bad before the byte is read.

A minimum size packet has an 8-bit address, an 8-bit control byte, and a 16-bit FCS pattern between the opening and closing flags. Thus, the absence of a data transmission error and a frame length of at least 32 bits results in the receiver writing a valid packet code with the EOP byte into RX FIFO. The last 16 bits before the closing flag are regarded as the FCS pattern and will not be transferred to the receiver FIFO. Only data bytes (Address, Control, Information) are loaded into the Rx FIFO.

In the case of an RX FIFO overflow, no clocking occurs until a new opening flag is received. In other words, the remainder of the packet is not clocked into the FIFO. Also, the top byte of the FIFO will not be written over. If the FIFO is read before the reception of the next packet then reception of that packet will occur. If two beginning of packet conditions (RQ9=0; RQ8=1) are seen in the FIFO, without an intermediate EOP status, then overflow occurred for the first packet.

The receiver may be enabled independently of the transmitter. This is done by setting the RxEN bit of Control Register 1. Enabling happens immediately upon writing to the register. Disabling using RxEN will occur after the present packet has been completely loaded into the FIFO. Disabling can occur during a packet if no bytes have been written to the FIFO yet. Disabling will consist of disabling the internal receive clock. The FIFO, Status, and Interrupt Registers may still be read while the receiver is disabled. Note that the receiver requires a flag before processing a frame, thus if the receiver is enabled in the middle of an incoming packet it will ignore that packet and wait for the next complete one.

The receive CRC (FCS) can be monitored in the Rx CRC Registers (address 18H and 19H). These registers contain the actual CRC sent by the other transmitter in its original form, that is, MSB first and bits inverted. These registers are updated by each end of packet (closing flag) received and therefore should be read when an end of packet is received so that the next packet does not overwrite the registers.

Slip Buffer

In addition to the elastic buffer in the jitter attenuator(JA), another elastic buffer (two frames deep) is present, attached between the receive side and the ST-BUS (or GCI Bus) side of the MT9075A. This elastic buffer is configured as a slip buffer which absorbs wander and low frequency jitter in multi-trunk applications. The received PCM 30 data is clocked into the slip buffer with the E_{20} clock and is clocked out of the slip buffer with the $\overline{C_{4b}}$ clock. The E_{20} extracted clock is generated from, and is therefore phase-locked with, the receive PCM 30 data. In normal operation, the E_{20} clock will be phase-locked to the $\overline{C_{4b}}$ clock by an external phase locked loop (PLL). Therefore, in a single trunk system the receive data is in phase with the E_{20} clock, the $\overline{C_{4b}}$ clock is phase-locked to the E_{20} clock, and the read and write positions of the slip buffer will remain fixed with respect to each other.

In a multi-trunk slave or loop-timed system (i.e., PABX application) a single trunk will be chosen as a network synchronizer, which will function as described in the previous paragraph. The remaining trunks will use the system timing derived from the synchronizer to clock data out of their slip buffers. Even though the PCM 30 signals from the network are synchronous to each other, due to multiplexing, transmission impairments and route diversity, these signals may jitter or wander with respect to the synchronizing trunk signal. Therefore, the E_{20} clocks of non-synchronizer trunks may wander with respect to the E_{20} clock of the synchronizer and the system bus.

Network standards state that, within limits, trunk interfaces must be able to receive error-free data in the presence of jitter and wander (refer to network requirements for jitter and wander tolerance). The MT9075A will allow a maximum of 26 channels (208 UI, unit intervals) of wander and low frequency jitter before a frame slip will occur.

The minimum delay through the receive slip buffer is approximately two channels and the maximum delay is approximately 60 channels (see Figure 9).

When the $\overline{C_{4b}}$ and the E_{20} clocks are not phase-locked, the rate at which data is being written into the slip buffer from the PCM 30 side may differ from the rate at which it is being read out onto the ST-BUS. If this situation persists, the delay limits stated in the previous paragraph will be violated and the slip buffer will perform a controlled frame slip. That is, the buffer pointers will be automatically adjusted so that a full PCM 30 frame is either repeated or lost. All frame slips occur on PCM 30 frame boundaries.

Two status bits, RSLIP and RSLPD (page 03H, address 15H), give indication of a slip occurrence and direction. RSLIP changes state in the event of a slip. If RSLPD=0, the slip buffer has overflowed and a frame was lost; if RSLPD=1, a underflow condition occurred and a frame was repeated. A maskable interrupt SLPI (page 01H, address 1BH) is also provided.

Figure 9 illustrates the relationship between the read and write pointers of the receive slip buffer. Measuring clockwise from the write pointer, if the read pointer comes within two channels of the write pointer a frame slip will occur, which will put the read pointer 34 channels from the write pointer. Conversely, if the read pointer moves more than 60 channels from the write pointer, a slip will occur, which will put the read pointer 28 channels from the write pointer. This provides a worst case hysteresis of 13 channels peak (26 channels peak-to-peak) or a wander tolerance of 208 UI.

Framing Algorithm

The MT9075A contains three distinct framing algorithms: basic frame alignment, signalling multiframe alignment and CRC-4 multiframe alignment. Figure 10 is a state diagram that illustrates these algorithms and how they interact.

After power-up, the basic frame alignment framer will search for a frame alignment signal (FAS) in the PCM 30 receive bit stream. Once the FAS is detected, the corresponding bit 2 of the non-frame alignment signal (NFAS) is checked. If bit 2 of the NFAS is zero a new search for basic frame alignment is initiated. If bit 2 of the NFAS is one and the next FAS is correct, the algorithm declares that basic frame

synchronization has been found (i.e., page 03H, address 10H, bit 7, SYNC is zero).

Once basic frame alignment is acquired the signalling and CRC-4 multiframe searches will be initiated. The signalling multiframe algorithm will align to the first multiframe alignment signal pattern (MFAS = 0000) it receives in the most significant nibble of channel 16 (page 3, address 10H, bit 6, MFSYNC = 0). Signalling multiframing will be lost when two consecutive multiframes are received in error.

The CRC-4 multiframe alignment signal is a 001011 bit sequence that appears in PCM 30 bit position one of the NFAS in frames 1, 3, 5, 7, 9 and 11 (see Table 7). In order to achieve CRC-4 synchronization two CRC-4 multiframe alignment signals must be received without error (page 03H, address 10H, bit 5, CRCSYN = 0) within 8 msec.

The MT9075A framing algorithm supports automatic interworking of interfaces with and without CRC-4 processing capabilities. That is, if an interface with CRC-4 capability, achieves valid basic frame alignment, but does not achieve CRC-4 multiframe alignment by the end of a predefined period, the distant end is considered to be a non-CRC-4 interface. When the distant end is a non-CRC-4 interface, the near end automatically suspends receive CRC-4 functions, continues to transmit CRC-4 data to the distant end with its E-bits set to zero, and provides a status indication. Naturally, if the distant end initially achieves CRC-4 synchronization, CRC-4 processing will be carried out by both ends. This feature is selected when control bit AUTC (page 01H, address 11H) is set to zero.

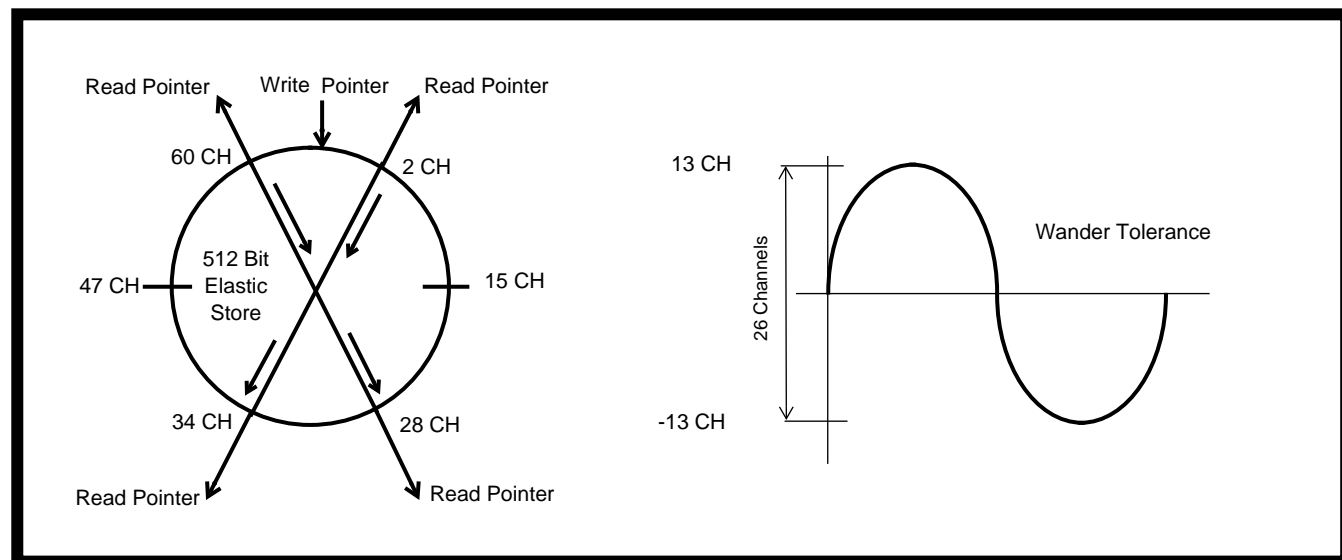
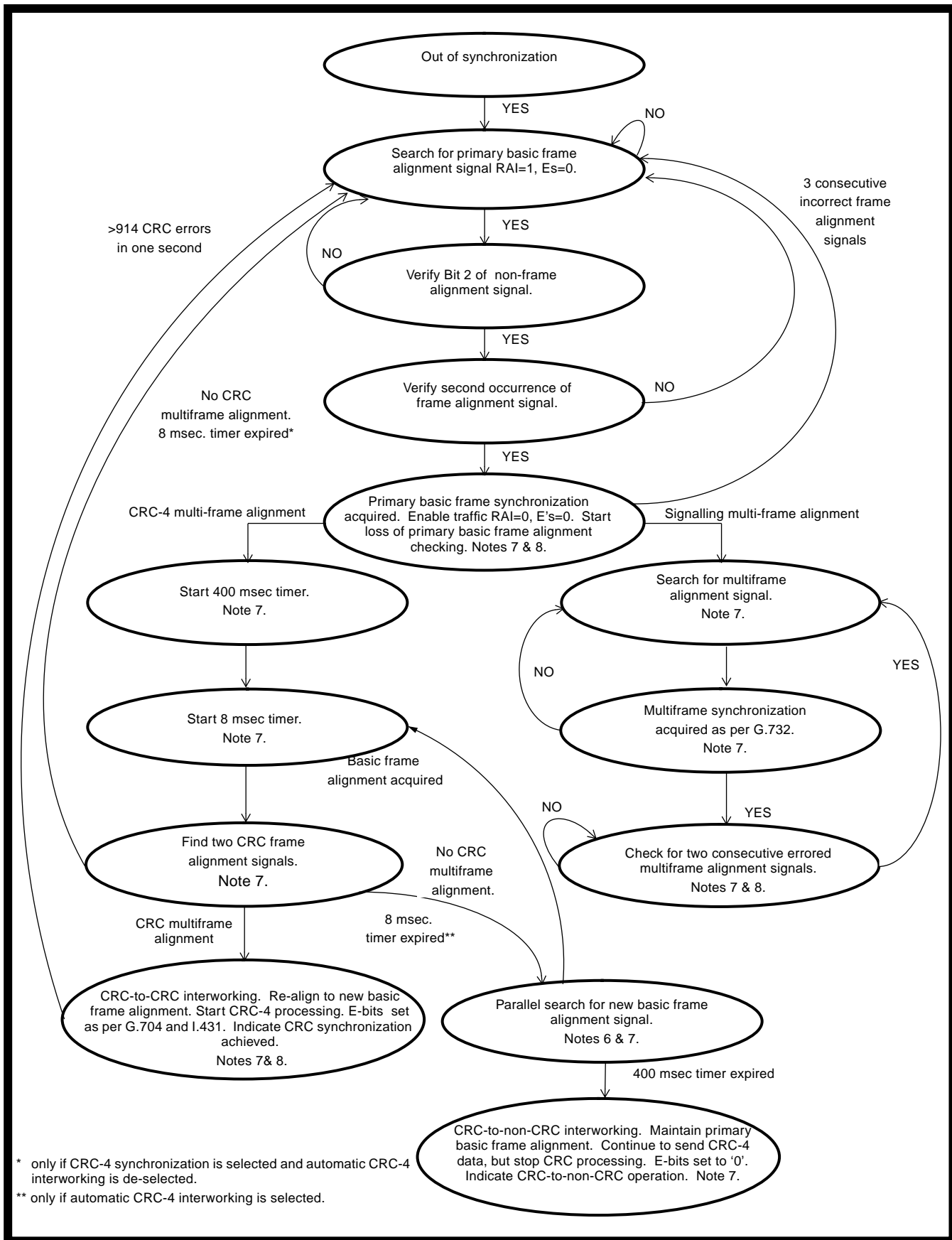

Figure 9 - Read and Write Pointers in the Slip Buffers



* only if CRC-4 synchronization is selected and automatic CRC-4 interworking is de-selected.
 ** only if automatic CRC-4 interworking is selected.

Figure 10 - Synchronization State Diagram

Notes for Synchronization State Diagram (Figure 10)

- 1) The basic frame alignment, signalling multiframe alignment, and CRC-4 multiframe alignment functions operate in parallel and are independent.
- 2) The receive channel associated signalling bits and signalling multiframe alignment bit will be frozen when multiframe alignment is lost.
- 3) Manual re-framing of the receive basic frame alignment and signalling multiframe alignment functions can be performed at any time.
- 4) The transmit RAI bit will be one until basic frame alignment is established, then it will be zero.
- 5) E-bits can be optionally set to zero until the equipment interworking relationship is established. When this has been determined one of the following will take place:
 - a) CRC-to-non-CRC operation - E-bits = 0,
 - b) CRC-to-CRC operation - E-bits as per G.704 and I.431.
- 6) All manual re-frames and new basic frame alignment searches start after the current frame alignment signal position.
- 7) After basic frame alignment has been achieved, loss of frame alignment will occur any time three consecutive incorrect basic frame alignment signals are received. Loss of basic frame alignment will reset the complete framing algorithm.
- 8) When CRC-4 multiframing has been achieved, the primary basic frame alignment and resulting multiframe alignment will be adjusted to the basic frame alignment determined during CRC-4 synchronization. Therefore, the primary basic frame alignment will not be updated during the CRC-4 multiframing search, but will be updated when the CRC-4 multiframing search is complete.

Channel Signalling

When control bit TxCCS (page 01H, address 1AH) is set to one, the MT9075A is in Common Channel Signalling (CCS) mode. When TxCCS is low it is in Channel Associated Signalling mode (CAS). The CAS mode ABCD signalling nibbles can be passed either via the micro-ports (when page 01H, address 1AH, bit 3, RPSIG = 1) or through related channels of the CSto and CSTi serial links (when RPSIG = 0).

Memory page 05H contains the receive ABCD nibbles and page 06H the transmit ABCD nibbles for micro-port CAS access.

In CAS operation an ABCD signalling bit debounce of 14 msec. can be selected by writing a one to DBNCE (page 02H, address 10H, bit 0)). This is consistent with the signalling recognition time of ITU-T Q.422. It should be noted that there may be as much as 2 msec. added to this duration because signalling equipment state changes are not synchronous with the PCM 30 multiframe.

If multiframe synchronization is lost (page 03H, address 10H, bit 6, $\overline{\text{MFSYNC}} = 1$) all receive CAS signalling nibbles are frozen. Receive CAS nibbles will become unfrozen when multiframe synchronization is acquired.

When the CAS signalling interrupt is unmasked (page 01H, address 1CH, bit 0, SIGI=0), pin $\overline{\text{IRQ}}$ (pin 12 in PLCC, 85 in MQFP) will become active when a signalling nibble state change is detected in any of the 30 receive channels. The SIGI interrupt vector (page 04H, address 12H) is 01H.

In CCS mode the data transmit on channel 16 is either sourced from channel 16 data on DSTi or from the pin CSTi. If 64KCCS (page 01H, address 1AH, bit 0) is zero the data is sourced from DSTi. If 64KCCS is high data destined for channel 16 is clocked in from CSTi (pin 6 in PLCC, pin 71 in MQFP) with an internal 64 KHz clock divided down from $\overline{\text{C4b}}$. Data received from channel 16 is clocked out on CSto (pin 5 in PLCC, pin 70 in MQFP). By dividing down the extracted 2.048 MHz clock, a 64 kHz receive clock synchronous with the data is created. This signal is output on Rx64KCK (pin 47 in PLCC, pin 35 in MQFP).

Loopbacks

In order to meet PRI Layer 1 requirements and to assist in circuit fault sectionalization, the MT9075A has six loopback functions. The control bits for digital, remote, ST-BUS, payload and metallic loopbacks are located on page 01H, address 15H. The remote and local time slot loopbacks are controlled through control bits 5 and 4 of the Per Time Slot Control Words on pages 07H and 08H.

- a) *Digital Loopback* (DG Loop) - DSTi to DSto at the framer LIU interface. Bit DLBK = 0 normal; DLBK = 1 activate.

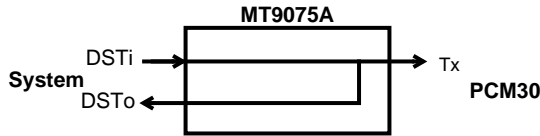

b) *Remote Loopback (RM Loop)* - RTIP and RRING to TTIP and TRING respectively at the PCM 30 side. Bit RLBK = 0 normal; RLBK = 1 activate.

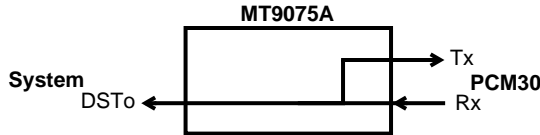

c) *ST-BUS Loopback (ST Loop)* - DSTi to DSTo at the system side. Bit SLBK = 0 normal; SLBK = 1 activate.

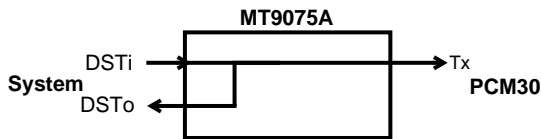

d) *Payload Loopback (PL Loop)* - RTIP and RRING to TTIP and TRING respectively at the system side with FAS and NFAS operating normally. Bit PLBK = 0 normal; PLBK = 1 activate. The payload loopback is effectively a physical connection of DSTo to DSTi within the MT9075A. Channel zero and the DL originate at the point of loopback.

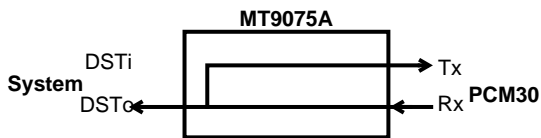

e) *Metallic Loopback (MT Loop)* - The external signals RTIP and RRING are isolated from the receiver and the analog outputs TTIP and TRING are internally connected to the receiver analog input. Bit MLBK = 0 normal; MLBK = 1 activate.

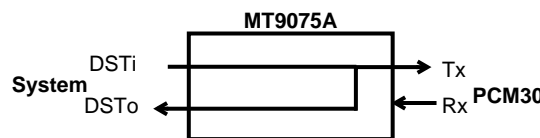

f) *Local and Remote Time Slot Loopback.* Remote time slot loopback control bit RTSL = 0 normal; RTSL = 1 activate, will loop around receive PCM 30 time

slots to the transmit PCM 30 time slots. Local time slot loopback bit LTSL = 0 normal; LTSL = 1 activate, will loop around DSTi time slots towards the DSTo time slots.

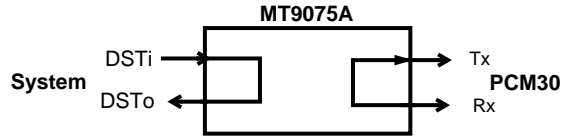

Error Counters

The MT9075A has nine error counters, which can be used for maintenance testing, an ongoing measure of the quality of a PCM 30 link and to assist the designer in meeting specifications such as ITU-T I.431 and G.821. All counters can be preset or cleared by writing to the appropriate locations. A separate status page - "1 Second Status" on page 09H - latches the states of the following counters: E-bit Error Counter, Errored Frame Alignment Signal Counter, Bipolar Violation Counter and CRC Error Counter on a one second interval, coincident with the one second status bit.

Associated with each counter is a maskable event occurrence interrupt and a maskable counter overflow interrupt. Overflow interrupts are useful when cumulative error counts are being recorded. For example, every time the frame error counter overflow (FERO) interrupt occurs, 256 frame errors have been received since the last FERO interrupt. All counters are cleared and held low by programming the counter clear bit (master control page 01H, address 1AH, bit 2) high. Counter overflows set bits in the counter overflow latch (page 04H, address 16H); this latch is cleared when read.

The overflow reporting latch (page 04H, address 16H) contains a register whose bits are set when individual counters overflow. These bits stay high until the register is read.

PRBS Error Counter (PS7-0)

There are two 8 bit counters associated with PRBS comparison; one for errors and one for time. Any errors that are detected in the receive PRBS will increment the PRBS Error Rate Counter of page 04H, address 10H. Writes to this counter will clear an 8 bit counter, PSM7-0 (page 01H, address 11H) which counts receive CRC-4 multiframes. A maskable PRBS counter overflow (PRBSO) interrupt (page 1, address 19H) is associated with this counter.

CRC Multiframe Counter for PRBS (PSM7-0)

This eight bit counter counts receive CRC-4 multiframe. It can be directly loaded via the microport. The counter will also be automatically cleared in the event that the PRBS error counter is written to by the microport. This counter is located on page 04H, address 11H.

E-bit Counter (EC9-0)

E-bit errors are counted by the MT9075A in order to support compliance with ITU-T requirements. This ten bit counter is located on page 04H, addresses 13H and 14H respectively. It is incremented by single error events, with a maximum rate of twice per CRC-4 multiframe.

There are two maskable interrupts associated with the E-bit error measurement. EBI (page 1, address 1CH) is initiated when the least significant bit of the counter toggles, and EBO (page 01H, address 1DH) is initiated when the counter overflows.

Jitter FIFO Counter (JFC7-0)

This is an eight bit counter that is incremented when the FIFO read pointer comes within 4 words of an underflow or overflow condition. During this time the read clock will abruptly speed-up or slow-down to avoid an overflow or underflow condition. This counter is located on page 04H, address 15H.

Loss of Synchronization Counter (LBF7-0)

This eight bit counter increments with each loss of basic frame alignment. This programmable counter is located on page 04H, address 17H.

Bit Error Rate Counter (BR7-BR0)

An 8 bit Error Rate (BERT) counter BR7 - BR0 is located on page 04H address 18H, and is incremented once for every bit detected in error on either the seven frame alignment signal bits.

There are two maskable interrupts associated with the bit error rate measurement. BERI (page 01H, address 1CH) is initiated when the least significant bit of the BERT counter (BR0) toggles, and BERO (page 01H, address 1DH) is initiated when the BERT counter value changes from FFH to 00H.

Errored FAS Counter (EFAS7-EFAS0)

An eight bit Frame Alignment Signal Error counter EFAS7 - EFAS0 is located on page 04H address 1AH, and is incremented once for every receive frame alignment signal that contains one or more errors.

There are two maskable interrupts associated with the frame alignment signal error measurement. FER1 (page 01H, address 1BH) is initiated when the least significant bit of the errored frame alignment signal counter toggles, and FER0 (page 01H, address 1DH) is initiated when the counter changes from FFH to 00H.

Bipolar Violation Error Counter (BPV15-BPV0)

The bipolar violation error counter will count bipolar violations or encoding errors that are not part of HDB3 encoding. This counter BPV15-BPV0 is 16 bits long (page 04H, addresses 1DH and 1CH) and is incremented once for every BPV error received. It should be noted that when presetting or clearing the BPV error counter, the least significant BPV counter address should be written to before the most significant location.

There are two maskable interrupts associated with the bipolar violation error measurement. BPVI (page 01H, address 1CH) is initiated when the least significant bit of the BPV error counter toggles. BPVO (page 01H, address 1BH) is initiated when the counter changes from FFFFH to 0000H.

CRC Error Counter (CC9-0)

CRC-4 errors are counted by the MT9075A in order to support compliance with ITU-T requirements. This ten bit counter is located on page 04H, addresses 1EH and 1FH respectively. It is incremented by single error events, which is a maximum rate of twice per CRC-4 multiframe.

There is a maskable interrupts associated with the CRC error measurement. CRCI (page 01H, address 1CH) is initiated when the least significant bit of the counter toggles, and CRCO (page 01H, address 1DH) is initiated when the counter overflows.

Error Insertion

Six types of error conditions can be inserted into the transmit PCM 30 data stream through control bits, which are located on page 02H, address 10H. These error events include the bipolar violation errors

(BPVE), CRC-4 errors (CRCE), FAS errors (FASE), NFAS errors (NFSE), payload (PERR) and a loss of signal error (LOSE). The LOSE function overrides the HDB3 encoding function.

Per Time Slot Control

There are two per time slot control pages (page 07H and 08H) occupying a total of 32 unique addresses. Each address controls a matching timeslot on the 32 transmit channels (onto the line) and the equivalent channel data on the receive (DSTo) data. For example, address 0 of the first per time slot control page contains program control for transmit timeslot 0 and DSTo channel 0.

Per Time Slot Looping

Any channel or combination of channels may be looped from transmit (sourced from DSTi) to receive (output on DSTo) STBUS channels. When bit 4 (LTSL) in the Per Time Slot Control Word is set the data from the equivalent transmit timeslot is looped back onto the equivalent receive channel.

Any channel or combination of channels may be looped from receive (sourced from the line data) to transmit (output onto the line) channels. When bit 5 (RTSL) in the Per Time Slot Control Word is set the data from the equivalent receive timeslot is looped back onto the equivalent transmit channel.

PRBS Testing

If the control bit ADSEQ is zero (from master control page 02H address 13H - Access Control Word), any channel or combination of transmit channels may be programmed to contain a generated pseudo random bit sequence ($2^{15}-1$). The channels are selected by setting bit 3 (TTST) in the Per Time Slot Control Word.

If the control bit ADSEQ is zero any combination of receive channels may be connected to the PRBS decoder ($2^{15}-1$). Each error in the incoming sequence causes the PRBS error counter to increment. The receive channels are selected by setting bit 2 (RRST) in the Per Time Slot Control Word.

If the PRBS testing is performed in a metallic or external looparound the Per Time Slot Control Words with TTST (transmit test, bit 3) set should have RRST (receive test, bit 2) set at the same time.

A-law Milliwatt

If the control bit ADSEQ is one (from master control page 02H - access control word), the A-law digital milliwatt sequence (Table 10), defined by G.711, is available to be transmit on any combination of selected channels. The channels are selected by setting bit 3 (TTST), in the Per Time Slot Control Word.

The same sequence is available to replace received data on any combination of DSTo channels. This is accomplished by setting bit 2 (RRST) in the Per Time Slot Control Word for the corresponding channel.

Bit 1	Bit 2	Bit 3	Bit 4	Bit 5	Bit 6	Bit 7	Bit 8
0	0	1	1	0	1	0	0
0	0	1	0	0	0	0	1
0	0	1	0	0	0	0	1
0	0	1	1	0	1	0	0
1	0	1	1	0	1	0	0
1	0	1	0	0	0	0	1
1	0	1	1	0	0	0	1

Table 10 - A-Law Digital Milliwatt Pattern

Message Mode

The transmit data on any of the transmit channels may be sourced either from the equivalent DSTi channel or from a dual port RAM programmed by the microport. The address of each dual port RAM memory location is uniquely associated with a transmit channel number. When bit 7 (TXMSG) in the Per Time Slot Control Word for that channel is set the transmit data for the channel is sourced from within the transmit message page dual port RAM (on page 0FH and 10H).

Receive data may also be read by the microprocessor port. The Rx message mode dual port RAMs (on page 11H and 12H) have a unique address associated with each incoming line channel. When the processor reads any of the 32 memory locations, it reads the last byte received from the corresponding channel.

Alarms

The following alarms are detected by the receiver. Each may generate a maskable interrupt:

- Remote Alarm Indication (RAI) - bit 3 (A) of the receive NFAS;

- Alarm Indication Signal (AIS) - unframed all ones signal for at least a double frame (512 bits) or two double frames (1024 bits);
- Channel 16 Alarm Indication Signal - all ones signal in channel 16;
- Auxiliary pattern - 101010... pattern for at least 512 bits;
- Loss of Signal - a loss of signal condition occurs when the receive signal is detected with more than 255 consecutive zeros. A loss of signal condition will terminate when an average ones density of at least 12.5% has been received over a period of 255 contiguous pulse positions starting with a pulse.
- Remote Signalling Multiframe Alarm - bit 6 (Y-bit) of the multiframe alignment signal.
- T1 - (T1 timer bit on page 03H address 12H) this status bit (and maskable interrupt) shall be high when a signal that is not normal has been received for a minimum of 100 msec. This bit will be low when a normal signal is being received.
- T2 - (T2 timer bit on page 03H address 12H) this status bit (and maskable interrupt) shall be high when a normal signal has been received for a minimum of 10 msec. This bit will be low when an abnormal signal is being received.

The alarm reporting latch (address 1BH page 04H) contains a register whose bits are set high for selected alarms. These bits stay high until the register is read. This allows the controller to record intermittent or sporadic alarm occurrences.

Automatic Alarms

The signalling multiframe alarm can be made to function automatically from control bit AUTY (page 01H, address 11H). When AUTY = 0 and signalling multiframe alignment is not acquired (page 03H, address 10H, bit 6, $\overline{MFSYNC} = 1$), the MT9075A will automatically transmit the multiframe alarm (Y-bit) signal to the far end of the link. This transmission will cease when signalling multiframe alignment is acquired.

Interrupts

The MT9075A has an extensive suite of maskable interrupts, which are divided into eight categories based on the type of event that caused the interrupt. Each interrupt category has an associated interrupt vector described in Table 11. When unmasked interrupts occur, \overline{IRQ} will go low and one or more bits of the interrupt vector IV7-IV0 (page 04H, address

12H) will go high. After the interrupt vector is read it is automatically cleared and \overline{IRQ} will return to a high impedance state. The interrupt acknowledgment function can also be accomplished by toggling the INTA bit (page 01H, address 1AH).

All the interrupts of the MT9075A are maskable. This is accomplished through the corresponding interrupt mask words on page 01H (except for the HDLC interrupt mask registers which are located on page 0BH and 0CH).

National Use Bit Interrupt Mask Word (address 19H)

Bit 7	Bit 0
---	PRBSO PRBS SanibI SabitI C8Sa6I Sa6I Sa5I

Interrupt Mask Word Zero (address 1BH)

Bit 7	Bit 0
SYNI	RAII AISI AISI6I LOSI FERI BPVO SLPI

Interrupt Mask Word One (address 1CH)

Bit 7	Bit 0
EBI	CRCI CEFI BPVI RCR1 RCR0 BERI SIGI

Interrupt Mask Word Two (address 1DH)

Bit 7	Bit 0
EBO	CRCO CALNI FER0 JAI BERO AUXPI CMFO

Interrupt Mask Word Three (address 1EH)

Bit 7	Bit 0
MFSYI CSYNI	--- YI 1SEC T1I T2I ---

HDLC Interrupt Masks (page 0BH&0CH, address 16H)

Bit 7	Bit 0
Ga	EOPD TEOP EopR TxFl FATxU RxFf RxOv

After a device reset (\overline{RESET} pin or RST control bit), interrupts from the following interrupt mask words are masked:

- National use bit interrupt mask word
- Interrupt mask words one through three.
- HDLC interrupt mask word.

and the interrupts of mask word zero are unmasked.

All interrupts may be suspended, without changing the interrupt mask words, by making the SPND control bit (page 01H, address 1AH) high. Also, when pin TAIS is held low, all interrupts are suspended automatically. This allows for system initialization without spurious interrupts.

Interrupt Category and Vector	Interrupt Description
Synchroniza- tion D7 D0 10000000	SYNI - Loss of Synchronization. MFSYI - Loss of Multiframe Sync. CSYNI - Loss of CRC-4 Sync. YI - Remote Multiframe Sync. Fail.
Alarm D7 D0 01000000	RAII - Remote Alarm Indication. AISI - Alarm Indication Signal. AIS16I - AIS on Channel 16. LOSI - Loss of Signal. AUXPI - Auxiliary Pattern.
Counter Indication D7 D0 00100000	EBI - Receive E-bit Error. CRCI - CRC-4 Error. CEFI - Consecutive Errored FASs. FERI - Frame Alignment Signal Error. BPVI - Bipolar Violation Error. RCR0 - RAI and CRC Error Active. RCR1 - RAI and CRC Error End. BERI - Bit Error.
Counter Overflow D7 D0 00010000	EBO - Receive E-bit Error. CRCO - CRC-4 Error. FERO - Frame Alignment Signal. BPVO - Bipolar Violation. BERO - Bit Error. CMFO - CRC-4 Multiframe.
One Second D7 D0 00001000	1SECI - One Second Timer. CALNI - CRC-4 Multiframe Alignment. T1I - Timer T1 expires. T2I - Timer T2 expires.
SLIP D7 D0 00000100	SLPI - Receive Slip. JAI - Jitter Attenuator Error.
National Use/ HDLC0 D7 D0 00000010	PRBSO-PRBS Error Counter Overflow PRBSI - PRBS Single Error Sanibl - Changed S _{a5,6,7 or 8} Nibble Sabitl - Changed S _{a5,6,7 or 8} Bits C8SA6I- Sequence of 8 S _{a6} nibbles. SA6I - Changed S _{a6} nibbles. SA5I - Changed S _{a5} bits. HDLC0 - Status
Signalling/ HDLC1 D7 D0 00000001	SIGI-Receive Signalling Bit Change. HDLC1 - Status.

Table 11 - MT9075A Interrupt Vectors
(IV7 - IV0)

Control and Status Registers

Master Control 1 (Page 01H)

Address (A ₄ A ₃ A ₂ A ₁ A ₀)	Register	Names
10H (Table 13)	Multiframe, National Bit Buffer and Data Link Selection Word	ASEL, MFSEL, NBTB & S _{a4} - S _{a8}
11H (Table 14)	Mode Selection Control Word	TIU0, CRCM, RST, $\overline{\text{AUTY}}$, TxTRSP, $\overline{\text{CSYN}}$ & AUTC
12H (Table 15)	Non-Frame Alignment Control Word	TIU1, TALM & TNU4-8
13H (Table 16)	Transmit Multiframe Alignment Signal	TMA1-4, X1, Y, X2 & X3
14H (Table 17)	HDLC Selection Word	HDLC0, HDLC1, RxTRSP
15H (Table 18)	Coding and Loopback Control Word	MLBK, $\overline{\text{HDB3}}$, MFRF, DLBK, RLBK, SLBK & PLBK
16H (Table 19)	Transmit Alarm Control Word	TAIS, TAIS0, TAIS16, TE, REFRM, 64KSEL, $\overline{\text{DSToDE}}$ & $\overline{\text{CSToDE}}$
17H	Reserved	Set all bits to zero for normal operation.
18H	---	Unused.
19H (Table 20)	National Use Bit Interrupt Mask Word	PRBSO, PRBSI, S _a nibl, S _a bitl, C8S _{a6} l, S _{a6} l, S _{a5} l
1AH (Table 21)	Interrupt, Signalling and BERT Control Word	ODE, SPND, INTA, TxCCS, RPSIG, CNTCLR & MSN, 64KCCS
1BH (Table 22)	Interrupt Mask Word Zero	SYNI, RAI, AISI, AIS16I, LOSI, FERI, BPVO & SLPI
1CH (Table 23)	Interrupt Mask Word One	EBI, CRCI, CEFI, BPVI, RCR0I, RCR1I, BERI & SIGI
1DH (Table 24)	Interrupt Mask Word Two	EBOI, CRCOI, CALNI, FEROI, JAI, BEROI, AUXPI & CMFOI
1EH (Table 25)	Interrupt Mask Word Three	MFSYI, CSYNI, YI, 1SECI, T1I, T2I
1FH (Table 26)	Transmit Pulse Control Word	LL0, LL1, LL2

Table 12 - Master Control 1 (Page 01H)

Bit	Name	Functional Description
7	ASEL	AIS Select. This bit selects the criteria on which the detection of a valid Alarm Indication Signal (AIS) is based. If zero, the criteria is less than three zeros in a two frame period (512 bits). If one, the criteria is less than three zeros in each of two consecutive double-frame periods (512 bits per double-frame).
6	MFSEL	Multiframe Select. This bit determines which receive multiframe signal (CRC-4 or signalling) the \overline{RxMF} (pin 42 in PLCC, 23 in MQFP) signal is aligned with. If zero, \overline{RxMF} is aligned with the receive signalling multiframe. If one, \overline{RxMF} is aligned with the receive CRC-4 multiframe.
5	NBTB	National Bit Transmit Buffer. If one, the transmit NFAS signal originates from the transmit national bit buffer; if zero, the transmit NFAS signal originates from the TNU4-8 bits of page 01H, address 12H.
4 - 0	$S_{a4} - S_{a8}$	A one selects the corresponding S_a bits of the NFA signal for 4, 8, 12, 16 or 20 kbits/sec. data link channel. Data link (DL) selection will function in termination mode only; in transmit transparent mode S_{a4} is automatically selected - see TxTRSP control bit of page 01H, address 11H. If zero, the corresponding bits of transmit non-frame alignment signal are programmed by the Non-Frame Alignment Control Word (page 01H, address 12H).

Table 13 - Multiframe National Bit Buffer and DL Selection Word (Page 01H, Address 10H)

Bit	Name	Functional Description
7	TIU0	Transmit International Use Zero. When $\overline{CSYN}=1$, this bit is transmit on the PCM 30 2048 kbit/sec. link in bit position one of time-slot zero of frame-alignment frames. It is reserved for international use and should normally be kept at one. If CRC processing is used, i.e., $\overline{CSYN}=0$, this bit is ignored.
6	CRCM	CRC-4 Modification. If one, activates the CRC-4 remainder modification function when the device is in transparent mode. The received CRC-4 remainder is modified to reflect only the changes in the transmit DL. If zero, time slot zero data from DSTi will not be modified in transparent mode.
5	RST	Reset. When this bit is changed from zero to one the device will reset to its default mode. See the Reset Operation section for the default settings.
4	---	Unused. Set high for normal operation.
3	\overline{AUTY}	Automatic Y-Bit Operation. If zero, the Y-bit of the transmit multiframe alignment signal will report the multiframe alignment status to the far end i.e., zero - multiframe alignment acquired, one - lost. If one, the Y-bit is under the manual control of the Transmit Multiframe Alignment Control Word.
2	TxTRSP	Transmit Transparent Mode. If one, the MT9075A is in transmit transparent mode. No framing or signaling is imposed on the data transmit from DSTi onto the line. If zero, it is in termination mode.

Table 14 - Mode Selection Control Word (Page 01H, Address 11H)

1	$\overline{\text{CSYN}}$	CRC-4 Synchronization. If zero, basic CRC-4 synchronization processing is activated, and TIU0 bit and TIU1 bit programming will be overwritten. If one, CRC-4 synchronization is disabled, the first bits of channel 0 are used as international use bits and are programmed by TIU0 and TIU1.
0	$\overline{\text{AUTC}}$	Automatic CRC-interworking. If zero, automatic CRC-interworking is activated. If one, it is deactivated. See Framing Algorithm section for a detail description.

Table 14 - Mode Selection Control Word (Page 01H, Address 11H)

Bit	Name	Functional Description
7	TIU1	Transmit International Use One. When CRC-4 operation is disabled ($\overline{\text{CSYN}}=1$), this bit is transmit on the PCM 30 2048 kbit/sec. link in bit position one of time-slot zero of non-frame-alignment frames. It is reserved for international use and should normally be kept at one. If CRC processing is used, i.e., $\overline{\text{CSYN}}=0$, this bit is ignored.
6	---	Unused. Set low for normal operation.
5	TALM	Transmit Remote Alarm. This bit is transmitted on the PCM 30 2048 kbit/sec. link in bit position three (A bit) of time slot zero of NFAS frames. It is used to signal an alarm to the remote end of the PCM 30 link (one - alarm, zero - normal). This control bit is ignored when $\overline{\text{ARAI}}$ is zero (page 01H, address 11H).
4-0	TNU4-8	Transmit National Use Four to Eight ($S_{a4} - S_{a8}$). These bits are transmitted on the PCM 30 2048 kbit/sec. link in bit positions four to eight of time slot zero of the NFA frame, if selected by $S_{a4} - S_{a8}$ control bits of the DL selection word (page 01H, address 10H).

Table 15 - NFA Control Word (page 01H, Address 12H)

Bit	Name	Functional Description
7-4	TMA1-4	Transmit Multiframe Alignment Bits One to Four. These bits are transmitted on the PCM 30 2048 kbit/sec. link in bit positions one to four of time slot 16 of frame zero of every signalling multiframe. These bits are used by the far end to identify specific frames of a signalling multiframe. TMA1-4 = 0000 for normal operation.
3	X1	This bit is transmitted on the PCM 30 2048 kbit/sec. link in bit position five of time slot 16 of frame zero of every multiframe. X1 is normally set to one.
2	Y	This bit is transmitted on the PCM 30 2048 kbit/sec. link in bit position six of time slot 16 of frame zero of every multiframe. It is used to indicate the loss of multiframe alignment to the remote end of the link. If one - loss of multiframe alignment; if zero - multiframe alignment acquired. This bit is ignored when $\overline{\text{AUTY}}$ is zero (page 01H, address 11H).
1-0	X2, X3	These bits are transmitted on the PCM 30 2048 kbit/sec. link in bit positions seven and eight respectively, of time slot 16 of frame zero of every multiframe. X2 and X3 are normally set to one.

Table 16 - Transmit MF Alignment Signal (Page 01H, Address 13H)

Bit	Name	Functional Description
7	HDLC0	HDLC0 Select. If one, then HDLC0 is connected to the data link on selected S _a bits at a rate of 4, 8, 12, 16 or 20 kbits/sec. If zero, HDLC0 is deselected and all HDLC0 interrupts are masked.
6	HDLC1	HDLC1 Select. If one, then HDLC1 is connected to time slot 16 in CCS mode. If zero, HDLC1 is deselected and all HDLC1 interrupts are masked.
5	RxTRSP	Receive Transparent Mode. When this bit is set to one, the framing function is disabled on the receive side. Data coming from the receive line passes through the slip buffer and drives DST ₀ with an arbitrary alignment. When zero, the receive framing function operates normally.
4-0	---	Unused.

Table 17 - HDLC Selection Word
(Page 01H, Address 14H)

Bit	Name	Functional Description
7	---	Unused.
6	MLBK	Metallic Loopback. If one, then the external RRTIP and RRING signals are isolated from the receiver, and TTIP and TRING are internally connected to the receiver analog input instead. If zero, metallic loopback is disabled.
5	HDB3	High Density Bipolar 3 Encoding. If zero, HDB3 encoding is enabled in the transmit direction. If one, AMI signal without HDB3 encoding is transmitted. HDB3 is always decoded in the receive direction.
4	MFRF	Multiframe Reframe. If one, for at least one frame, and then cleared the MT9075A will initiate a search for a new signalling multiframe position. Reframing function is activated on the one-to-zero transition of the MFRF bit.
3	DLBK	Digital Loopback. If one, then the digital stream to the transmit LIU is looped back in place of the digital output of the receive LIU. Data coming out of DST ₀ will be a delayed version of DST _i . If zero, this feature is disabled.
2	RLBK	Remote Loopback. If one, then all bipolar data received on RRTIP/RRING are directly routed to TTIP/TRING on the PCM 30 side of the MT9075A. If zero, then this feature is disabled.
1	SLBK	ST-BUS Loopback. If one, then all time slots of DST _i are connected to DST ₀ on the ST-BUS side of the MT9075A. If zero, then this feature is disabled. See Loopbacks section.
0	PLBK	Payload Loopback. If one, then all time slots received on RTIP/RRING are connected to TTIP/TRING on the ST-BUS side of the MT9075A (this excludes time slot zero). If zero, then this feature is disabled.

Table 18 - Coding and Loopback Control Word
(Page 01H, Address 15H)

Bit	Name	Functional Description
7	TAIS	Transmit Alarm Indication Signal. If one, an all ones signal is transmitted. TAIS=0 for normal operation.
6	TAIS0	Transmit AIS Time Slot Zero. If one, an all ones signal is transmitted in time slot zero. If zero, time slot zero functions normally.
5	TAIS16	Transmit AIS Time Slot 16. If one, an all ones signal is transmitted in time slot 16. If zero, time slot functions normally.
4	TE	Transmit E bits. When zero and CRC-4 synchronization is achieved, the E-bits transmit the received CRC-4 comparison results to the distant end of the link, as per G.704. That is, when zero and CRC-4 synchronization is lost, the transmit E-bits will be zero. If one, and CRC-4 synchronization is lost the transmit E-bits will be one.
3	REFRM	Reframe. If one for at least one frame, and then cleared, the device will initiate a search for a new basic frame position. Reframing function is activated on the one-to-zero transition of the REFRM bit.
2	64KSEL	64 KHz Select. If one, a 64 KHz signal divided down from the extracted received 2048 kbit/sec. clock is output on RxFP/Rx64KCK (pin 47 in PLCC, 35 in MQFP). If zero that pin outputs an 8 KHz signal derived from the extracted clock.
1	$\overline{\text{DSToDE}}$	DSTo Data Enable. If zero, DSTo is enabled. If one, DSTo will be tristated if one of the following conditions exists: LIU loss of signal, loss of terminal frame sync ($\overline{\text{SYNC}}=1$), loss of CRC4 sync ($\overline{\text{CRCSYN}}=1$) or AIS.
0	$\overline{\text{CSToDE}}$	CSTo Data Enable. If zero, CSTo is enabled. If one, CSTo will be tristated if one of the following conditions exists: loss of multiframe sync ($\overline{\text{MFSYNC}}=1$), or AIS16 =1

Table 19 - Transmit Alarm Control Word (Page 01H, Address 16H)

Bit	Name	Functional Description
7	---	Unused.
6	PRBSO	PRBS Counter Overflow Interrupt. When unmasked (PRBSO = 1), an interrupt is initiated on overflow of PRBS counter (page 04H, address 10H) from FFH to 0H. Interrupt vector = 00000010.
5	PRBSI	PRBS Interrupt. When unmasked (PRBSI = 1), an interrupt is initiated on a single PRBS detection error. Interrupt vector = 00000010.
4	$S_{a\text{nibl}}$	Changed S_a Nibble Interrupt. When unmasked ($S_{a\text{nibl}} = 1$), an interrupt is generated upon detection of a change of state in any of received S_a nibbles (nibble S_{a5} , nibble S_{a6} , nibble S_{a7} or nibble S_{a8}). Interrupt vector = 00000010.
3	$S_{a\text{bitl}}$	Changed S_a Bit Interrupt. When unmasked ($S_{a\text{bitl}} = 1$), an interrupt is generated upon detection of a change of state in any of received S_a bits (S_{a5} , S_{a6} , S_{a7} or S_{a8}). Interrupt vector = 00000010.
2	$C8S_{a6l}$	Eight Consecutive S_{a6} Nibble Interrupt. When unmasked ($C8S_{a6l} = 1$), an interrupt is generated upon detection of the eighth consecutive S_{a6} nibble with the same pattern. Interrupt vector = 00000010.
1	S_{a6l}	Changed S_{a6} Nibble Interrupt. When unmasked ($S_{a6l} = 1$), an interrupt is generated upon detection of a change of state in received S_{a6} nibbles. Interrupt vector = 00000010.
0	S_{a5l}	Changed S_{a5} Bit Interrupt. When unmasked ($S_{a5l} = 1$), an interrupt is generated upon detection of a change of state in the received S_{a5} bit. Interrupt vector = 00000010.

Table 20 - National Use Bit Interrupt Mask Word (Page 01H, Address 19H)

Bit	Name	Functional Description
7	ODE	Output Data Enable. If one, the DSTo and CSTo output drivers function normally. When low, DSTo and CSTo will be tristated. Note: When ODE =1, DSTo and CSTo can be individually tristated by $\overline{\text{DSToDE}}$ and $\overline{\text{CSToDE}}$ (page 01H, address 16H) respectively.
6	SPND	Suspend Interrupts. If one, the $\overline{\text{IRQ}}$ output (pin 12 in PLCC, 85 in MQFP) will be in a high-impedance state and all interrupts will be ignored. If zero, the $\overline{\text{IRQ}}$ output will function normally.
5	INTA	Interrupt Acknowledge. A zero-to-one or one-to-zero transition will clear <u>any</u> pending interrupt and make $\overline{\text{IRQ}}$ high.
4	TxCCS	Transmit Common Channel Signalling. If one, the transmit section of the device is in common channel signalling (CCS) mode. If zero, it is in Channel Associated Signalling (CAS) mode.
3	RPSIG	Register Programmed Signalling. If one, the transmit CAS signalling will be controlled by programming page 05H. If zero, the transmit CAS signalling will be controlled through the CSTi stream.

Table 21 - Interrupt, Signalling and BERT Control Word (Page 01H, Address 1AH) (continued)

Bit	Name	Functional Description
2	CNTCLR	Counter Clear. If one, all status counters are cleared and held low. Zero for normal operation.
1	MSN	Most Significant Signalling Nibble. If one, the CSTo and CSTi channel associated signalling nibbles will be valid in the most significant portion of each ST-BUS time slot. If zero, the CSTo and CSTi channel associated signalling nibbles will be valid in the least significant portion of each ST-BUS time slot.
0	64KCCS	64 Kbits/s Common Channel Signalling. If one, common channel signalling information is sourced from CSTi, and common channel signalling information is clocked out of CSTo. The transmit clock is an internal clock. This 64 KHz clock is divided down from $\overline{\text{C4b}}$ and is synchronous with the STBUS channel boundaries. The rising edges of the clock occur between channels 1 and 2; 5 and 6; 9 and 10; 13 and 14; 17 and 18; 21 and 22; 25 and 26; 29 and 30. The receive clock is synchronous with the same channel times, but derived from the extracted clock timebase. The CCS receive clock is driven out on Rx64KCK (pin 47 in PLCC, 35 in MQFP) when this bit is set.

Table 21 - Interrupt, Signalling and BERT Control Word (Page 01H, Address 1AH)

Bit	Name	Functional Description
7	SYNI	Synchronization Interrupt. When unmasked (SYNI = 0) an interrupt is initiated when a loss of basic frame synchronization condition exists. Interrupt vector = 10000000.
6	RAII	Remote Alarm Indication Interrupt. When unmasked (RAII = 0) a received RAI will initiate an interrupt. Interrupt vector = 01000000.
5	AISI	Alarm Indication Signal Interrupt. When unmasked (AISI = 0) a received AIS will initiate an interrupt. Interrupt vector = 01000000.
4	AIS16I	Channel 16 Alarm Indication Signal Interrupt. When unmasked (AIS16I = 0), a received AIS16 will initiate an interrupt. Interrupt vector = 01000000.
3	LOSI	Loss of Signal Interrupt. When unmasked (LOSI = 0) an interrupt is initiated when a loss of signal condition exists. Interrupt vector = 01000000.
2	FERI	Frame Error Interrupt. When unmasked (FERI = 0), an interrupt is initiated when an error in the frame alignment signal occurs. Interrupt vector = 00100000.
1	BPVO	Bipolar Violation Counter Overflow Interrupt. When unmasked (BPVO = 0), an interrupt is initiated when the bipolar violation error counter changes from FFFFH to 0H. Interrupt vector = 00010000.
0	SLPI	SLIP Interrupt. When unmasked (SLPI = 0), an interrupt is initiated when a controlled frame slip occurs. Interrupt vector = 00000100.

**Table 22 - Interrupt Mask Word Zero
(Page 01H, Address 1BH)**

Bit	Name	Functional Description
7	EBI	Receive E-bit Interrupt. When unmasked an interrupt is initiated when a receive E-bit indicates a remote CRC-4 error. 1 - unmasked, 0 - masked. Interrupt vector = 00100000.
6	CRCI	CRC-4 Error Interrupt. When unmasked an interrupt is initiated when a local CRC-4 error occurs. 1 - unmasked, 0 - masked. Interrupt vector = 00100000.
5	CEFI	Consecutively Errored FASs Interrupt. When unmasked an interrupt is initiated when two consecutive errored frame alignment signals are received. 1 - unmasked, 0 - masked. Interrupt vector = 00100000.
4	BPVI	Bipolar Violation Interrupt. When unmasked an interrupt is initiated when a bipolar violation error occurs. 1 - unmasked, 0 - masked. Interrupt vector = 00100000.
3	RCR0I	RAI and Continuous CRC Error Interrupt. When unmasked an interrupt is initiated when the received A bit has been one, and the received E bits have been zero, continuously for greater than 10 milliseconds (see page 04H, address 19H) 1- unmasked, 0 - masked. Interrupt vector = 00100000.
2	RCR1I	RAI and Continuous CRC Error Interrupt. When unmasked an interrupt is initiated when the received A bit had been set, and the received E bits were low, continuously for greater than 10 milliseconds, but less than 450 milliseconds (see page 04H, address 19H). 1 - unmasked, 0 - masked. Interrupt vector = 00100000.
1	BERI	Bit Error Interrupt. When unmasked an interrupt is initiated when a bit error occurs. 1 - unmasked, 0 - masked. Interrupt vector = 00100000.

**Table 23 - Interrupt Mask Word One
(Page 01H, Address 1CH) (continued)**

Bit	Name	Functional Description
0	SIGI	Signalling (CAS) Interrupt. When unmasked and any of the receive ABCD bits of any channel changes state an interrupt is initiated. 1 - unmasked, 0 - masked. Interrupt vector = 00000001

Table 23 - Interrupt Mask Word One (Page 01H, Address 1CH)

Bit	Name	Functional Description
7	EBOI	Receive E-bit Counter Overflow Interrupt. When unmasked an interrupt is initiated when the E-bit error counter overflows. 1 - unmasked, 0 - masked. Interrupt vector = 00010000.
6	CRCOI	CRC-4 Error Counter Overflow Interrupt. When unmasked an interrupt is initiated when the CRC-4 error counter overflows. 1 - unmasked, 0 - masked. Interrupt vector = 00010000.
5	CALNI	CRC-4 Alignment Interrupt. When unmasked an interrupt is initiated when the CALN status bit of page 03H, address 12H changes state. 1 - unmasked, 0 - masked. Interrupt vector = 00001000.
4	FEROI	Frame Alignment Signal Error Counter Overflow Interrupt. When unmasked an interrupt is initiated when the frame alignment signal error counter overflows. 1 - unmasked, 0 - masked. Interrupt vector = 00010000.
3	JAI	Jitter Attenuation Interrupt. When unmasked, an interrupt will be initiated when the jitter attenuator FIFO comes within four bytes of an overflow or underflow condition. 1 - unmasked, 0 - masked. Interrupt vector = 00000100.

Table 24 - Interrupt Mask Word Two (Page 01H, Address 1DH) (continued)

Bit	Name	Functional Description
2	BEROI	Bit Error Counter Overflow Interrupt. When unmasked (BERO = 1), an interrupt is initiated when the bit error counter overflows. Interrupt vector = 00010000.
1	AUXPI	Auxiliary Pattern Interrupt. When unmasked (AUXPI = 1), an interrupt is initiated when the AUXP status bit of page 03H, address 15H goes high. Interrupt vector = 01000000.
0	CMFOI	Receive CRC-4 Multiframe Counter Overflow Interrupt. When unmasked (CMFO = 1), an interrupt is initiated when the CRC-4 multiframe counter overflows. Interrupt vector = 00010000.

Table 24 - Interrupt Mask Word Two (Page 01H, Address 1DH)

Bit	Name	Functional Description
7	MFSYI	Multiframe Synchronization Interrupt. When unmasked (MFSYI = 1), an interrupt is initiated when multiframe synchronization is lost. Interrupt vector = 10000000.
6	CSYNI	CRC-4 Multiframe Synchronization Interrupt. When unmasked (CSYNI = 1), an interrupt is initiated when CRC-4 multiframe synchronization is lost. Interrupt vector = 10000000.
5	---	Unused.
4	YI	Remote Signalling Multiframe Alarm Interrupt. When unmasked (YI = 1), an interrupt is initiated when a remote signalling multiframe alarm signal is received. Interrupt vector = 10000000.

Table 25: Interrupt Mask Word Three (Page 01H, Address 1EH)

Bit	Name	Functional Description
3	1SECI	One Second Status Interrupt. When unmasked (1SECI = 1), an interrupt is initiated when the 1SEC status bit (page 03H, address 12H, bit 7) changes from zero to one. Interrupt vector = 00001000.
2	T1I	T1 Timer Interrupt. When unmasked (T1I = 1), an interrupt is initiated when the T1 timer bit (page 03H, address 12H, bit 5) changes from zero to one. Interrupt vector = 00001000.
1	T2I	T2 Timer Interrupt. When unmasked (T2I = 1), an interrupt is initiated when the T2 timer bit (page 03H, address 12H, bit 4) changes from zero to one. Interrupt vector = 00001000.
0	---	Unused

Table 25: Interrupt Mask Word Three (Page 01H, Address 1EH)

Bit	Name	Functional Description																																																						
7-3	---	Unused. Set low for normal operation.																																																						
2-0	TX2-0	<p>Transmit pulse amplitude. Select the TX2-TX0 bits according to the line type, value of termination resistors (R_T), and transformer turns ratio used</p> <table border="1"> <thead> <tr> <th>TX2</th> <th>TX1</th> <th>TX0</th> <th>Line(Ω)</th> <th>$R_T(\Omega)$</th> <th>Xfmr</th> </tr> </thead> <tbody> <tr> <td>0</td> <td>0</td> <td>0</td> <td>120</td> <td>0</td> <td>1:2</td> </tr> <tr> <td>0</td> <td>0</td> <td>1</td> <td>120</td> <td>0</td> <td>1:1</td> </tr> <tr> <td>0</td> <td>1</td> <td>0</td> <td>120</td> <td>15</td> <td>1:2</td> </tr> <tr> <td>0</td> <td>1</td> <td>1</td> <td>120/75</td> <td>12.1</td> <td>1:2</td> </tr> <tr> <td>1</td> <td>0</td> <td>0</td> <td>75</td> <td>0</td> <td>1:2</td> </tr> <tr> <td>1</td> <td>0</td> <td>1</td> <td>75</td> <td>0</td> <td>1:1</td> </tr> <tr> <td>1</td> <td>1</td> <td>1</td> <td>75</td> <td>9.1</td> <td>1:2</td> </tr> <tr> <td>1</td> <td>1</td> <td>1</td> <td>75/120</td> <td>12.1</td> <td>1:2</td> </tr> </tbody> </table>	TX2	TX1	TX0	Line(Ω)	$R_T(\Omega)$	Xfmr	0	0	0	120	0	1:2	0	0	1	120	0	1:1	0	1	0	120	15	1:2	0	1	1	120/75	12.1	1:2	1	0	0	75	0	1:2	1	0	1	75	0	1:1	1	1	1	75	9.1	1:2	1	1	1	75/120	12.1	1:2
TX2	TX1	TX0	Line(Ω)	$R_T(\Omega)$	Xfmr																																																			
0	0	0	120	0	1:2																																																			
0	0	1	120	0	1:1																																																			
0	1	0	120	15	1:2																																																			
0	1	1	120/75	12.1	1:2																																																			
1	0	0	75	0	1:2																																																			
1	0	1	75	0	1:1																																																			
1	1	1	75	9.1	1:2																																																			
1	1	1	75/120	12.1	1:2																																																			

Table 26: Transmit Pulse Control Word

Address (A ₄ A ₃ A ₂ A ₁ A ₀)	Register	Names
10H (Table 28)	Error and Debounce Selection Word	BPVE, CRCE, FASE, NFSE, LOSE, PERR & DBNCE
11H	---	Unused.
12H	---	Unused.
13H (Table 29)	Access Control Word	LOS/LOF, ADSEQ & GCI/ \overline{ST}
14H	---	Unused.
15H	---	Unused.
16H	---	Unused.
17H	---	Unused.
18H (Table 30)	Jitter Attenuator Control Word	JAS, JAT/ \overline{JAR} , JFC, JFD2, JFD1, JFD0, JACL
19H (Table 31)	Receive Equalization Control Word	REDBL, REMID, REMAX
1AH	Reserved	Set all bits to zero for normal operation.
1BH	Reserved	Set all bits to zero for normal operation.
1CH	Reserved	Set all bits to zero for normal operation.
1DH	Reserved	Set all bits to zero for normal operation.
1EH	Reserved	Set all bits to zero for normal operation.
1FH	Reserved	Set all bits to zero for normal operation.

Table 27: Master Control 2 (Page 02H)

Bit	Name	Functional Description
7	BPVE	Bipolar Violation Error Insertion. A zero-to-one transition of this bit inserts a single bipolar violation error into the transmit PCM 30 data. A one, zero or one-to-zero transition has no function.
6	CRCE	CRC-4 Error Insertion. A zero-to-one transition of this bit inserts a single CRC-4 error into the transmit PCM 30 data. A one, zero or one-to-zero transition has no function.
5	FASE	Frame Alignment Signal Error Insertion. A zero-to-one transition of this bit inserts a single error into the time slot zero frame alignment signal of the transmit PCM 30 data. A one, zero or one-to-zero transition has no function.
4	NFSE	Non-frame Alignment Signal Error Insertion. A zero-to-one transition of this bit inserts a single error into bit two of the time slot zero non-frame alignment signal of the transmit PCM 30 data. A one, zero or one-to-zero transition has no function.
3	LOSE	Loss of Signal Error Insertion. If one, the MT9075A transmits an all zeros signal (no pulses) in every PCM 30 time slot. If zero, data is transmitted normally.
2	PERR	Payload Error Insertion. A zero-to-one transition of this bit inserts a single error in the transmit payload. A one, zero or one-to-zero transition has no function.
1	---	Unused.
0	DBNCE	Debounce Select. This bit selects the debounce period (1 for 14 msec.; 0 for no debounce). Note: there may be as much as 2 msec. added to this duration because the state change of the signalling equipment is not synchronous with the PCM 30 signalling multiframe.

Table 28 - Error and Debounce Selection Word (Page 02H, Address 10H)

Bit	Name	Functional Description
7-3	--	Unused.
2	LOS/LOF	Loss of Signal or Loss of Frame Selection. If one, pin LOS (pin 61 in PLCC, 57 in MQFP) will go high when a loss of signal state exits (criteria as per LLOS status bit on page 03H address 18H). If low, pin LOS will go high when either a loss of signal (LLOST =1) or a loss of basic frame alignment state exits (bit SYNC on page 03H address 10H is zero).
1	ADSEQ	Digital Milliwatt or Digital Test Sequence. If one, the A-law digital milliwatt analog test sequence will be selected by the Per Time Slot Control bits TTST and RTST (on page 07H and 08H). If zero, the PRBS $2^{15}-1$ bit error rate test sequence will be selected by the Per Time Slot Control bits TTST and RTST. The PRBS generator is reset whenever this bit is set to 1.
0	GCI/ $\overline{\text{ST}}$	GCI or ST-BUS Frame Pulse. If one, the MT9075A will transmit or receive a GCI frame pulse on pin $\overline{\text{F0b}}$ (pin 46 in PLCC, 34 in MQFP). If zero, the MT9075A will transmit or receive an ST-BUS frame pulse on $\overline{\text{F0b}}$.

Table 29 - Access Control Word (Page 02H, Address 13H)

Bit	Name	Functional Description			
7	JAS	Jitter Attenuator Select. If one, the attenuator may be connected to either the transmit or receive sides of the PCM 30 interface depend on bit 6 - JAT/JAR. If zero, the jitter attenuator function is disabled.			
6	JAT/JAR	Transmit or Receive Jitter Attenuator. If one, the jitter attenuator will function on the transmit data. If zero, the jitter attenuator will function on the receive data.			
5	JFC	Jitter Attenuator FIFO Centre. When this bit is toggled the read pointer of the jitter attenuator shall be centered. During centering the jitter in the JA outputs is increased by 0.0625 U.I			
4 - 2	JFD2- JFD0	Jitter Attenuator FIFO Depth Control Bits. These bits determine the depth of the jitter attenuator FIFO as shown below:			
		JFD2	JFD1	JFD0	Depth (words)
		0	0	0	16
		0	0	1	32
		0	1	0	48
		0	1	1	64
		1	0	0	80
		1	0	1	96
		1	1	0	112
1	1	1	128		
1	JACL	Jitter Attenuator Clear bit. If one, the Jitter Attenuator, its FIFO and status are reset. The status registers will identify the FIFO as being empty. However, the actual bit values of the data in the JA FIFO will not be reset.			
0	---	Unused.			

Table 30 - Jitter Attenuator Control Word (Page 02H, Address 18H)

Bit	Name	Functional Description
7	REDBL	Receive Equalizer Auto Mode Disable. If one, the receive equalizer is turned off from the auto mode. If zero, the receive equalizer is turned on and will compensate for loop length automatically.
6	REMIC	Receive Equalization Mid-range. If one and REDBL is one, the one-stage equalization is enabled, which provides approximately 6 dB of gain. If zero, REDBL or REMAX will control the receive equalization.
5	REMAX	Receive Equalization Maximum. If one, REDBL is one and REMIC is zero, the two-stage equalization is enabled, which provides approximately 12 dB of gain. If zero, REDBL or REMIC will control the receive equalization.
4 - 0	---	Unused.

Table 31 - Receive Equalization Control Word (Page 02H, Address 19H)

Master Status 1 (Page 03H)

Address (A ₄ A ₃ A ₂ A ₁ A ₀)	Register	Names
10H (Table 33)	Synchronization Status Word	SYNC, MFSYNC, CRCSYN, REB1, REB2, CRCRF, RED & CRCIWK
11H (Table 34)	Receive Frame Alignment Signal	RIU0 & RFA2-8
12H (Table 35)	Timer Status Word	1SEC, 2SEC, T1, T2, 400T, 8T, CALN & KLVE
13H (Table 36)	Receive Non-frame Alignment Signal	RIU1, RNFA2, RALM & RNU4-8
14H (Table 37)	Receive Multiframe Alignment Signal	RMA1-4, X1, Y, X2 & X3
15H (Table 38)	Most Significant Phase Status Word	RSLIP, RSLPD, AUXP, CEFS, RxEBC11-8
16H (Table 39)	Least Significant Phase Status Word	RxEBC7-0
17H (Table 40)	Jitter Attenuator Status Word	JACS, JACF, JAE, JAF4, JAF4, JAE4, JAF
18H (Table 41)	Receive Signal Status Word	LL, ML, SL, LLOS
19H (Table 42)	Alarm Status Word One	CRCS1, CRCS2, RFAIL, LOSS, AIS16S, AISS, RAIS & RCRS
1AH (Table 43)	Changed S _{a6} Report Word	S _{a5} , S _{a6} nibble, C8S _{a6} , CS _{a6}
1BH - 1EH	---	Unused.
1FH (Table 44)	Identification Word	Set to 10101010

Table 32 - Master Status 1 (Page 03H)

Bit	Name	Functional Description
7	$\overline{\text{SYNC}}$	Receive Basic Frame Alignment. $\overline{\text{SYNC}}$ indicates the basic frame alignment status (1 - loss; 0 - acquired).
6	$\overline{\text{MFSYNC}}$	Receive Multiframe Alignment. $\overline{\text{MFSYNC}}$ indicates the multiframe alignment status (1 - loss; 0 - acquired).
5	$\overline{\text{CRCSYN}}$	Receive CRC-4 Synchronization. $\overline{\text{CRCSYN}}$ indicates the CRC-4 multiframe alignment status (1 - loss; 0 - acquired).
4	REB1	Receive E-Bit One Status. REB1 indicates the status of the received E1 bit of the last multiframe.
3	REB2	Receive E-Bit Two Status. REB2 indicates the status of the received E2 bit of the last multiframe.
2	CRCRF	CRC-4 Reframe. A one indicates that the receive CRC-4 multiframe synchronization could not be found within the time out period of 8 msec. after detecting basic frame synchronization. This will force a reframe when the maintenance option is selected and automatic CRC-4 interworking is de-selected.
1	RED	RED Alarm. RED goes high when basic frame alignment has been lost for at least 100 msec. This bit will be low when basic frame alignment is acquired (I.431).
0	CRCIWK	CRC-4 Interworking. CRCIWK indicates the CRC-4 interworking status (1 - CRC-to-CRC; 0 - CRC-to-non-CRC).

**Table 33 - Synchronization Status Word
(Page 03H, Address 10H)**

Bit	Name	Functional Description
7	RIU0	Receive International Use Zero. This is the bit which is received on the PCM 30 2048 kbit/sec. link in bit position one of the frame alignment signal. It is used for the CRC-4 remainder or for international use.
6 - 0	RFA2-8	Receive Frame Alignment Signal Bits 2 to 8. These bit are received on the PCM 30 2048 kbit/sec. link in bit positions two to eight of frame alignment signal. These bits form the frame alignment signal and should be 0011011.

**Table 34 - Receive Frame Alignment Signal
(Page 03H, Address 11H)**

Bit	Name	Functional Description
7	1SEC	One Second Timer Status. This bit changes state once every 0.5 second and is synchronous with the 2SEC timer. This feature is not available when the device is operated in freerun mode.
6	2SEC	Two Second Timer Status. This bit changes state once every second and is synchronous with the 1SEC timer. This feature is not available when the device is operated in freerun mode.
5	T1	Timer One. This bit will be high upon loss of terminal frame synchronization persisting for 100 msec. This bit shall be low when T2 becomes high. Refer to I.431 Section 5.9.2.2.3. This feature is not available when the device is operated in freerun mode.
4	T2	Timer Two. This bit will be high when the MT9075A acquires terminal frame synchronization persisting for 10 msec. This bit shall be low when non-normal operational frames are received. I.431 Section 5.9.2.2.3. This feature is not available when the device is operated in freerun mode.
3	400T	400 msec. Timer Status. This bit changes state when the 400 msec. CRC-4 multiframe alignment timer expires.
2	8T	8 msec. Timer Status. This bit changes state when the 8 msec. CRC-4 multiframe alignment timer expires.
1	CALN	CRC-4 Alignment. This bit changes state every msec. When CRC-4 multiframe alignment has been achieved state changes of this bit are synchronous with the receive CRC-4 synchronization signal.
0	KLVE	Keep Alive. This bit is high when the AIS status bit (page 03H, address 19H) has been high for at least 100msec. This bit will be low when AIS goes low (I.431).

**Table 35 - Timer Status Word
(Page 03H, Address 12H)**

Bit	Name	Functional Description
7	RIU1	Receive International Use 1. This bit is received on the PCM 30 2048 kbit/sec. link in bit position one of the non-frame alignment signal. It is used for CRC-4 multiframe alignment or international use.
6	RNFAB	Receive Non-frame Alignment Bit. This bit is received on the PCM 30 2048 kbit/sec. link in bit position two of the non-frame alignment signal. This bit should be one in order to differentiate between frame alignment frames and non-frame alignment frames.
5	RALM	Receive Alarm. This bit is received on the PCM 30 2048 kbit/sec. link in bit position three (the A bit) of the non-frame alignment signal. It is used as a remote alarm indication (RAI) from the far end of the PCM 30 link (1 - alarm, 0 - normal).
4 - 0	RNU4-8	Receive National Use Four to Eight. These bits are received on the PCM 30 2048 kbit/sec. link in bit positions four to eight (the S _a bits) of the non-frame alignment signal.

**Table 36 - Receive Non-Frame Alignment Signal
(Page 03H, Address 13H)**

Bit	Name	Functional Description
7 - 4	RMA1-4	Receive Multiframe Alignment Bits One to Four. These bits are received on the PCM 30 2048 kbit/sec. link in bit positions one to four of time slot 16 of frame zero of every signalling multiframe. These bit should be 0000 for proper signalling multiframe alignment.
3	X1	Receive Spare Bit X1. This bit is received on the PCM 30 2048 kbit/sec. link in bit position five of time slot 16 of frame zero of every signalling multiframe.
2	Y	Receive Y-bit. This bit is received on the PCM 30 2048 kbit/sec. link in bit position six of time slot 16 of frame zero of every signalling multiframe. The Y bit may indicate loss of multiframe alignment at the remote end (1 -loss of multiframe alignment; 0 - multiframe alignment acquired).
1 - 0	X2, X3	Receive Spare Bits X2 and X3. These bits are received on the PCM 30 2048 kbit/sec. link in bit positions seven and eight respectively, of time slot 16 of frame zero of every signalling multiframe.

Table 37 - Receive Multiframe Alignment Signal (Page 03H, Address 14H)

Bit	Name	Functional Description
7	RSLIP	Receive Slip. A change of state (i.e., 1-to-0 or 0-to-1) indicates that a receive controlled frame slip has occurred.
6	RSLPD	Receive Slip Direction. If one, indicates that the last received frame slip resulted in a repeated frame, i.e., system clock is faster than network clock. If zero, indicates that the last received frame slip resulted in a lost frame, i.e., system clock is slower than network clock. Updated on an RSLIP occurrence basis.
5	AUXP	Auxiliary Pattern. This bit will go high when a continuous 101010... bit stream (Auxiliary Pattern) is received on the PCM 30 link for a period of at least 512 bits. If zero, auxiliary pattern is not being received. This pattern will be decoded in the presence of a bit error rate of as much as 10^{-3} .
4	CEFS	Consecutively Errored Frame Alignment Signal. This bit goes high when the last two frame alignment signals were received in error. This bit will be low when at least one of the last two frame alignment signals is without error.
3-0	RxEBC 11-8	Receive Eighth Bit Count. The four most significant bit of a counter that indicates the number of one eighth bit times there are between the ST-BUS frame pulse and receive frame pulse (RxFP).

Table 38 - Most Significant Phase Status Word (Page 03H, Address 15H)

Bit	Name	Functional Description
7 - 0	RxEBC7 -0	Receive Eighth Bit Count. The 8 least significant bit of a counter that indicates the number of one eighth bit times there are between the ST-BUS frame pulse and receive frame pulse (\overline{RxFP}). The accuracy of the this measurement is approximately $\pm 1/16$ (one sixteenth) of a bit.

Table 39 - Least Significant Phase Status Word (Page 03H, Address 16H)

Bit	Name	Functional Description
7	JACS	Jitter Attenuated Clock Slow. If one it indicates that the dejittered clock period is increased by 1/16 UI. If zero the clock is at normal speed.
6	JACF	Jitter Attenuated Clock Fast. If one it indicates that the dejittered clock period is decreased by 1/16 UI. If zero the clock is at normal speed.
5	JAE	Jitter Attenuator FIFO Empty. If one it indicates that the JA FIFO is empty.
4	JAF4	Jitter Attenuator FIFO with 4 Full Locations. If one it indicates that the JA FIFO has at least 4 full locations.
3	J AFC	Jitter Attenuator Center Full. If one it indicates that the JA FIFO is at least half full.
2	JAE4	Jitter Attenuator FIFO with 4 Empty Locations. If one it indicates that the JA FIFO has at most 4 empty locations.
1	JAF	Jitter Attenuator FIFO Full. If one it indicates that the JA FIFO is full.
0	---	Unused

Table 40 - Jitter Attenuator Status Word (Page 03H, Address 17H)

Bit	Name	Functional Description
7	LL	Long Loop. This bit is one when the line signal has an amplitude so attenuated as to require substantial equalization for data recovery.
6	ML	Medium Loop. This bit is one when the line signal has an amplitude so attenuated as to require some equalization for data recovery.
5	SL	Short Loop. This bit is one when the line signal has an amplitude with minimal attenuation.
4	LLOS	LIU Loss of Signal Indication. This bit will be one when the received signal amplitude is more than 20 dB below the nominal value for a period of at least 1 msec. This bit will be zero for normal operation.
3-0	---	Unused

Table 41 - Receive Signal Status Word (Page 03H, Address 18H)

Bit	Name	Functional Description
7	CRCS1	Receive CRC Error Status One. If one, the evaluation of the last received submultiframe 1 resulted in an error. If zero, the last submultiframe 1 was error free. Updated on a submultiframe 1 basis.
6	CRCS2	Receive CRC Error Status Two. If one, the evaluation of the last received submultiframe 2 resulted in an error. If zero, the last submultiframe 2 was error free. Updated on a submultiframe 2 basis.
5	RFAIL	Remote CRC-4 Multiframe Generator/Detector Failure. If one, each of the previous five seconds have an E-bit error count of greater than 989, and for this same period the receive RAI bit was zero (no remote alarm), and for the same period the SYNC bit was equal to zero (basic frame alignment has been maintained). If zero, indicates normal operation.
4	LOSS	Loss of Signal Status Indication. If one, indicates the presence of a loss of signal condition. If zero, indicates normal operation. A loss of signal condition occurs when 255 consecutive bit periods are zero. A loss of signal condition terminates when an average ones density of at least 12.5% has been received over a period of 255 contiguous pulse positions starting with a pulse.
3	AIS16S	Alarm Indication Signal 16 Status. If one, indicates an all ones alarm is being received in channel 16. If zero, normal operation. Updated on a frame basis.
2	AISS	Alarm Indication Status Signal. If one, indicates that a valid AIS or all ones signal is being received. If zero, indicates that a valid AIS signal is not being received. The criteria for AIS detection is determined by the control bit ASEL (page 01H, address 10H).

Table 42 - Alarm Status Word One (Page 03H, Address 19H)(continued)

Bit	Name	Functional Description
1	RAIS	Remote Alarm Indication Status. If one, there is currently a remote alarm condition (i.e., received A bit is one). If zero, normal operation. Updated on a non-frame alignment frame basis.
0	R CRS	RAI and Continuous CRC Error Status. If one, there is currently an RAI and continuous CRC error condition. If zero, normal operation. Updated on a multiframe basis.

Table 42 - Alarm Status Word One (Page 03H, Address 19H)

Bit	Name	Functional Description
7	S _{a5}	S_{a5} Bit (latched by C8S_{a6}). It is cleared once this register is read.
6-3	S _{a6} nibble	S_{a6} Nibble (latched by C8S_{a6}). It is cleared once this register is read.
2	---	Unused
1	C8S _{a6}	Eight Consecutive S_{a6} nibbles. Upon detection of the eighth consecutive S _{a6} nibble with the same pattern, this bit goes high. It is cleared once this register is read.
0	CS _{a6}	Changed S_{a6} nibble. Upon detection of a change of state within the received S _{a6} nibbles, this bit goes high. It is cleared once this register is read.

Table 43 - Changed S_{a6} Report Word (Page 03H, Address 1AH)

Bit	Name	Functional Description
7 - 0	ID7-0	Contains device code 10101010.

Table 44 - Identification Word (Page 03H, Address 1FH)

Master Status 2 (Page 04H)

Address (A ₄ A ₃ A ₂ A ₁ A ₀)	Register	Names
10H (Table 46)	PRBS Error Counter	PS7-0
11H (Table 47)	CRC Multiframe counter for PRBS	PSM7-0
12H (Table 48)	Interrupt Vector	IV7 - IV0
13H (Table 49)	E-bit Error Counter Ebt	EC9-EC8
14H (Table 50)	E-bit Error Counter Ebt	EC7-EC0
15H (Table 51)	Jitter FIFO Counter	JFC7-JFC0
16H (Table 52)	Overflow Reporting Latch	PRBSO, FEBEO, JFO, LBO, BERO, EFO, BPVO, CCO
17H (Table 53)	Loss of Basic Synchronization Counter	LBF7-LBF0
18H (Table 54)	Bit Error Rate Counter	BR7 - BR0
19H (Table 55)	RAI and Continuous CRC Error Bits	RCRC1 - RCRC0
1AH (Table 56)	Errored Frame Alignment Signal Counter	EFAS7 - EFAS0
1BH (Table 57)	Alarm Reporting Latch	RAI, AIS, AIS16, LOS, AUXP, MFALM, RSLIP
1CH (Table 58)	Most Significant Bipolar Violation Error Counter	BPV15 - BPV8
1DH (Table 59)	Least Significant Bipolar Violation Error Counter	BPV7 - BPV0
1EH (Table 60)	CRC-4 Error Counter CEt	CC9-CC8
1FH (Table 61)	CRC-4 Error Counter CEt	CC7 - CC0

Table 45 - Master Status (Page 04H)

Bit	Name	Functional Description
7 - 0	PS7-0	PRBS Error Counter. This counter is incremented for each PRBS error detected on any of the receive channels connected to the PRBS error detector.

**Table 46 - PRBS Error Counter
(Page 04H, Address 10H)**

Bit	Name	Functional Description
7 - 0	PSM7-0	CRC Multiframe Counter for PRBS. This counter is incremented for each received CRC multiframe. It is cleared when the PRBS Error Counter is written to.

**Table 47 - CRC Multiframe Counter for PRBS
(Page 04H, Address 11H)**

Bit	Name	Functional Description
7 - 0	IV7 -IV0	Interrupt Vector. The interrupt vector status word contains an interrupt vector that indicates the category of the last interrupt as shown in Table 11.

**Table 48 - Interrupt Vector Status Word
(Page 04H, Address 12H)**

Bit	Name	Functional Description
7 - 2	---	Unused
1 - 0	EC9-8	E Bit Error Counter. The most significant 2 bits of the E bit error counter.

**Table 49 - E bit Error Counter
(Page 04H, Address 13H)**

Bit	Name	Functional Description
7 - 0	EC7-0	E bit Error Counter. The least significant eight bits of the E-bit error counter.

**Table 50 - E bit Error Counter
(Page 04H, Address 14H)**

Bit	Name	Functional Description
7 - 0	JFC7 - JFC0	Jitter FIFO Counter. This is an 8 bit counter that is incremented when the FIFO read pointer comes within 4 words of an underflow or overflow condition. During this time the read clock will abruptly slow-down or speed-up to avoid an overflow or underflow condition.

**Table 51 - Jitter FIFO Counter
(Page 04H, Address 15H)**

Bit	Name	Functional Description
7	PRBSO	PRBS Error Counter Overflow. This bit is set to one when the PRBS Error Counter (page 04H address 10H) overflows. It is cleared when this register is read.
6	FEBO	E Bit Counter Overflow. This bit is set to one when the E bit Counter (page 04H, address 13H & 14H) overflows. It is cleared when this register is read.
5	JFO	Jitter Attenuator FIFO Counter Overflow. This bit is set to one when the Jitter Attenuator FIFO Counter (page 04H, address 15H) overflows. It is cleared when this register is read.
4	LBO	Lost of Basic Frame Synchronization Counter Overflow. This bit is set to one when the Loss of Basic Frame Synchronization Counter (page 04H address 17H) overflows. It is cleared when this register is read.
3	BERO	Bit Error Rate Counter Overflow. This bit is set to one when the Bit Error Rate Counter (page 04H, address 18H) overflows. It is cleared when this register is read.
2	EFO	Errored Frame Alignment Signal Counter Overflow. This bit is set to one when the Errored Frame Alignment Signal Counter (page 04H, address 1AH) overflows. It is cleared when this register is read.
1	BPVO	Bipolar Violation Counter Overflow. This bit is set high when the Bipolar Violation Counter (page 04H, address 1CH & 1DH) overflows. It is cleared when this register is read.
0	CCO	CRC Error Counter Overflow. This bit is set high when the CRC Error Counter (page 04H, address 1EH & 1FH) overflows. It is cleared when this register is read.

**Table 52 - Overflow Reporting Latch
(Page 04H, Address 16H)**

Bit	Name	Functional Description
7 - 0	LBF7 - LBF0	Loss of Basic Frame Synchronization Counter. This eight bit counter will be incremented once for every 125 microsecond period in which basic frame synchronization is lost. It will be cleared by a basic frame synchronization to loss of basic frame synchronization state transition.

**Table 53 - Loss of Basic Synchronization Counter
(Page 04H, Address 17H)**

Bit	Name	Functional Description
7 - 0	BR7 - BR0	Bit Error Rate Counter. An eight bit counter that contains the total number of errors in the frame alignment signal.

**Table 54 - Bit Error Rate Counter
(Page 04H, Address 18H)**

Bit	Name	Functional Description
7 - 2	---	Unused
1	RCRC1	RAI and Continuous CRC Error bit 1. This bit goes high when received A (RAI) bits were high and receive E bits were low, continuously, for more than 10 milliseconds, but less than 450 milliseconds. This bit is cleared when read.
0	RCRC0	RAI and Continuous CRC Error Bit 0. This bit goes high when received A (RAI) bits are high and receive E bits are low, continuously, for more than 10 milliseconds.

**Table 55 - RAI With CRC Error Word
(Page 04H, Address 19H)**

Bit	Name	Functional Description
7 - 0	EFAS7 - EFAS0	Errored FAS Counter. An 8 bit counter that is incremented once for every receive frame alignment signal that contains one or more errors.

Table 56 - Errored Frame Alignment Signal Counter (Page 04H, Address 1AH)

Bit	Name	Functional Description
7	RAI	Remote Alarm Indication. This bit is set to one in the event of receipt of a remote alarm, i.e. A(RAI) = 1. It is cleared when the register is read.
6	AIS	Alarm Indication Signal. This bit is set to one in the event of receipt of an all ones alarm. It is cleared when the register is read.
5	AIS16	AIS Time Slot 16 Alarm. This bit is set to one in the event of receipt of an all ones alarm in the time slot 16. It is cleared when the register is read.
4	LOS	Loss of Signal. This bit is set to one in the event of loss of received signal. It is cleared when the register is read.
3	AUXP	Auxiliary Alarm. This bit is set to one in the event of receipt of the auxiliary alarm pattern. It is cleared when the register is read.
2	MFALM	Multiframe Alarm. This bit is set to one in the event of receipt of a multiframe alarm. It is cleared when the register is read.
1	RSLIP	Received Slip. This bit is set to one in the event of receive elastic buffer slip. It is cleared when the register is read.
0	---	Unused.

Table 57 - Alarm Reporting Latch (Page 04H, Address 1BH)

Bit	Name	Functional Description
7 - 0	BPV15 - BPV8	BPV Counter. The most significant eight bits of a 16 bit counter that is incremented once for every bipolar violation error received.

Table 58 - Most Significant Bits of the BPV Counter (Page 04H, Address 1CH)

Bit	Name	Functional Description
7 - 0	BPV7 - BPV0	BPV Counter. The least significant eight bits of a 16 bit counter that is incremented once for every bipolar violation error received.

Table 59 - Least Significant Bits of the PBV Counter (Page 04H, Address 1DH)

Bit	Name	Functional Description
7 - 2	---	Unused
1 - 0	CC9- CC8	CRC-4 Error Counter. The most significant eight bits of the CRC-4 error counter.

Table 60 - CRC-4 Error Counter (Page 04H, Address 1EH)

Bit	Name	Functional Description
7 - 0	CC7- CC0	CRC-4 Error Counter. The least significant eight bits of the CRC-4 error counter.

Table 61 - CRC-4 Error Counter (Page 04H, Address 1FH)

Per Channel Transmit Signalling (Page 05H)

Table 62 describes Page 05H, addresses 11H to 1FH, which contains the Transmit Signalling Control Words for PCM 30 channels 1 to 15 and 16 to 30. Control of these bits is through the processor or controller port when page 01H, address 1AH, bit 3, RPSIG = 1.

Bit	Name	Functional Description
7 - 4	A(n), B(n), C(n), D(n)	Transmit Signalling Bits for Channel n. These bits are transmitted on the PCM 30 2048 kbit/sec. link in bit positions one to four of time slot 16 in frame n (where n = 1 to 15), and are the A, B, C, D signalling bits associated with channel n.
3 - 0	A(n+15), B(n+15), C(n+15), D(n+15)	Transmit Signalling Bits for Channel n + 15. These bits are transmitted on the PCM 30 2048 kbit/sec. link in bit positions five to eight of time slot 16 in frame n (where n = 1 to 15), and are the A, B, C, D signalling bits associated with channel n + 15.

**Table 62 - Transmit Channel Associated Signalling
(Page 05H)**

Serial per channel transmit signalling control through CSTi is selected when bit RPSIG is zero. Table 63 describes the function of CSTi time slots 1 to 15, and Table 64 describes the function of CSTi time slots 17 to 31, when page 01H, address 1CH, bit 1, MSN = 1. If MSN = 0, the signalling nibble appears at least significant bits (bits 3-0).

Bit	Name	Functional Description
7 - 4	A(n), B(n), C(n), D(n)	Transmit Signalling Bits for Channel n. These bits are transmitted on the PCM 30 2048 kbit/sec. link in bit positions one to four of time slot 16 in frame n (where n = 1 to 15), and are the A, B, C, D signalling bits associated with channel n.
3 - 0	---	Unused.

Table 63 - Transmit CAS Channels 1 to 15 (CSTi)

Bit	Name	Functional Description
7 - 4	A(n+15), B(n+15), C(n+15), D(n+15)	Transmit Signalling Bits for Channel n + 15. These bits are transmitted on the PCM 30 2048 kbit/sec. link in bit positions five to eight of time slot 16 in frame n (where n = 1 to 15), and are the A, B, C, D signalling bits associated with channel n + 15.
3 - 0	---	Unused.

Table 64 - Transmit CAS Channels 16 to 30 (CSTi)

Per Channel Receive Signalling (Page 06H)

Page 06H, addresses 11H to 1FH contain the Receive Signalling Control Words for PCM 30 channels 1 to 15 and 16 to 30.

Bit	Name	Functional Description
7 - 4	A(n), B(n), C(n), D(n)	Receive Signalling Bits for Channel n. These bits are received on the PCM 30 2048 kbit/sec. link in bit positions one to four of time slot 16 in frame n (where n = 1 to 15), and are the A, B, C, D signalling bits associated with channel n.
3 - 0	A(n+15), B(n+15), C(n+15), D(n+15)	Receive Signalling Bits for Channel n + 15. These bits are received on the PCM 30 2048 kbit/sec. link in bit positions five to eight of time slot 16 in frame n (where n = 1 to 15), and are the A, B, C, D signalling bits associated with channel n + 15.

Table 65 - Receive CAS (Page 06H)

Serial per channel receive signalling status bits also appear on ST-BUS stream CSTo. Table 66 describes the function of CSTo time slots 1 to 15, and Table 67 describes the function of CSTo time slots 17 to 31, when page 01H, address 1CH, bit 1, MSN = 1. If MSN = 0, the signalling nibble appears at least significant bits (bits 3-0).

Bit	Name	Functional Description
7 - 4	A(n), B(n), C(n), D(n)	Receive Signalling Bits for Channel n. These bits are received on the PCM 30 2048 kbit/sec. link in bit positions one to four of time slot 16 in frame n (where n = 1 to 15), and are the A, B, C, D signalling bits associated with channel n.
3 - 0	---	Unused - High impedance state.

Table 66 - Receive CAS Channels 1 to 15 (CSTo)

Bit	Name	Functional Description
7 - 4	A(n+15), B(n+15), C(n+15), D(n+15)	Receive Signalling Bits for Channel n + 15. These bits are received on the PCM 30 2048 kbit/sec. link in bit positions five to eight of time slot 16 in frame n (where n = 1 to 15), and are the A, B, C, D signalling bits associated with channel n + 15.
3 - 0	---	Unused - High impedance state.

Table 67 - Receive CAS Channels 17 to 31 (CSTo)

Per Time Slot Control Words (Pages 07H and 08H)

The control functions described by Table 69 are repeated for each PCM-30 channel. Page 07H addresses 10H to 1FH correspond to time slots 0 to 15, while page 08H addresses 10H to 1FH correspond to time slots 16 to 31.

Page 07H Address:	0	1	2	3	4	5	6	7	8	9	10	11	12	13	14	15
Equivalent PCM 30 Timeslots	0	1	2	3	4	5	6	7	8	9	10	11	12	13	14	15
Page 08H Address:	0	1	2	3	4	5	6	7	8	9	10	11	12	13	14	15
Equivalent PCM 30 Timeslots	16	17	18	19	20	21	22	23	24	25	26	27	28	29	30	31

Table 68 - Mapping to CEPT Channels (Page 07H and 08H)

Bit	Name	Functional Description
7	TXMSG	Transmit Message Mode. If one, the data from the corresponding address location of Tx message mode buffer is transmitted in the corresponding PCM 30 time slot. If zero, the data on DSTi is transmitted on the corresponding PCM 30 time slot. Tx message mode buffer are accessed from pages 0FH and 10H.
6	ADI	Alternate Digit Inversion. If one, the corresponding transmit time slot data on DSTi has every second bit inverted, and the corresponding PCM 30 receive time slot has every second bit inverted. If zero, this bit has no effect on channel data.
5	RTSL	Remote Time Slot Loopback. If one, the corresponding PCM 30 receive time slot is looped to the corresponding PCM 30 transmit time slot. This received time slot will also be present on DSTo. If zero, the loopback is disabled.
4	LTSL	Local Time Slot Loopback. If one, the corresponding transmit time slot is looped to the corresponding receive time slot. This transmit time slot will also be present on the transmit PCM 30 stream. If zero, this loopback is disabled.
3	TTST	Transmit Test. If one and control bit ADSEQ (page 02H, address 13H) is one, the A-law digital milliwatt will be transmitted in the corresponding PCM 30 time slot. When one and ADSEQ is zero, a Pseudo-Random Bit Sequence (PRBS $2^{15}-1$) will be transmitted in the corresponding PCM 30 time slot. More than one time slot may be activated at once. If zero, neither of these test signals will be connected to the corresponding time slot.
2	RRST	Receive Test. If one and control bit ADSEQ (page 02H, address 13H) is one, the A-law digital milliwatt will be transmitted in the corresponding DSTo time slot. When one and ADSEQ is zero, a Pseudo Random Bit Sequence (PRBS $2^{15}-1$) receiver will be connected to the corresponding time slot. This receiver circuit will synchronize to the transmit PRBS signal and perform a bit comparison of the two sequences. If zero, neither of these test signals will be connected to the corresponding time slot.
1	---	Unused.
0	---	Unused.

Table 69 - Per Time Slot Control Word (Page 07H and 08H)

One Second Status (Page 09H)

Address (A ₄ A ₃ A ₂ A ₁ A ₀)	Register	Names
10H (Table 71)	MSB Latched E-bit Error Count	LEC9-LEC8
11H (Table 72)	LSB Latched E-bit Error Count	LEC7-LEC0
12H (Table 73)	Latched Errored Frame Alignment Signal Count	LEFAS7-LEFAS0
13H (Table 74)	MSB Latched BPV Error Count	LBPV15-LBPV8
14H (Table 75)	LSB Latched BPV Error Count	LBPV7-LBPV0
15H (Table 76)	MSB Latched CRC Error Count	LCC9-LCC8
16H (Table 77)	LSB Latched CRC Error Count	LCC7-LCC0
17H - 1FH	- - -	Unused.

Table 70 - One Second Status (Page 09H)

Bit	Name	Functional Description
7 - 2	---	Unused
1 - 0	LEC9 - LEC8	Latched E bit error counter (the most significant two bits). These bits are sampled every second by the internal one second timer.

Table 71 - Latched E-bit Error Counter (Page 09H, Address 10H)

Bit	Name	Functional Description
7 - 0	LEC7 - LEC0	Latched E Bit Error Counter (the least significant eight bits). These bits are sampled every second by the internal one second timer.

Table 72 - Latched E-bit Error Counter (Page 09H, Address 11H)

Bit	Name	Functional Description
7 - 0	LEFAS7 - LEFAS0	Latched Errored FAS Counter. An 8 bit counter that is incremented once for every receive frame alignment signal that contains one or more errors. These bits are sampled every second by the internal one second timer.

Table 73 - Latched Errored Frame Alignment Signal Counter (Page 09H, Address 12H)

Bit	Name	Functional Description
7 - 0	LBPV15 - LBPV8	Latched BPV Counter (most significant 8 bits). The BPV counter is incremented once for every bipolar violation error received. These bits are sampled every second by the internal one second timer.

Table 74 - Most Significant Bits of the Latched BPV Counter (Page 09H, Address 13H)

Bit	Name	Functional Description
7 - 0	LBPV7 - LBPV0	Latched BPV Counter (least significant 8 bits). The least significant eight bits of a 16 bit counter that is incremented once for every bipolar violation error received. These bits are sampled every second by the internal one second timer.

Table 75 - Least Significant Bits of the Latched BPV Counter (Page 09H, Address 14H)

Bit	Name	Functional Description
7 - 2	---	Unused
1 - 0	LCC9 - LCC8	Latched CRC-4 Error Counter (Bits 9 & 8). These are the most significant two bits of the CRC-4 error counter. These bits are sampled every second by the internal one second timer.

Table 76 - Latched CRC-4 Error Counter (Page 09H, Address 15H)

Bit	Name	Functional Description
7 - 0	LCC7 - LCC0	Latched CRC-4 Error Counter (Bits 7-0). These are the least significant eight bits of the CRC-4 error counter. These bits are sampled every second by the internal one second timer.

Table 77 - Latched CRC-4 Error Counter (Page 09H, Address 16H)

HDLC Control and Status (Page 0BH & 0CH)

Address	Register		Name
	Control (Write/Verify)	Status (Read)	
10H (Table 79)	Address Recognition 1	---	Adr16-Adr10, A1en
11H (Table 80)	Address Recognition 2	---	Adr26-Adr20, A2en
12H (Table 81) & (Table 82)	TX FIFO	RX FIFO	Bit7-Bit0
13H (Table 83)	HDLC Control 1	---	Adrec, RxEN, TxEN, EOP, FA, Mark-idle, RSV, RSV
14H (Table 84)	---	HDLC Status	Intgen, Idle-Chan, RQ9, RQ8, Txstat2, Txstat1, Rxstat2, Rxstat1
15H (Table 85)	HDLC Control 2	---	Intsel, Cycle, Tcrcl, Seven, RSV, RSV, Rxfrst, Txfrst
16H (Table 86)	Interrupt Mask	---	Ga, EOPD, TEOP, EOPR, TxFI, FA:Txunder, RxFf, RxOvfl
17H (Table 87)	---	Interrupt Status	Ga, EOPD, TEOP, EOPR, TxFI, FA:Txunder, RxFf, RxOvfl
18H (Table 88)	---	Rx CRC MSB	Crc15-Crc8
19H (Table 89)	---	Rx CRC LSB	Crc7-Crc0
1AH (Table 90)	TX byte count	---	Cnt7-Cnt0
1BH (Table 91)	Test Control	---	HRST, RTloop, RSV, RSV, RSV, Ftst, RSV, Hloop
1CH (Table 92)	---	Test Status	RXclk, TXclk, Vcrc, Vaddr
1DH (Table 93)	HDLC Control 3	---	RFD2-0, TFD2-0
1EH (Table 94)	HDLC Control 4	---	RFFS2-0, TFLS2-0

Table 78 - HDLC 0 & 1 Control and Status (Pages 0BH & 0CH)

Bit	Name	Functional Description
7 - 2	Adr16 - Adr11	A six bit mask used to interrogate the first byte of the received address. Adr16 is the MSB.
1	Adr10	This bit is used in address comparison, if control bit Seven, bit 4 of HDLC Control Register 2 (address 15H) is one.
0	A1en	When this bit is high, this six (or seven) bit mask is used in address comparison of the first address byte. If address recognition is enabled, any packet failing the address comparison will not be stored in the RX FIFO. A1en must be high for All-call (1111111) address recognition for single byte address. When this bit is low, this bit mask is ignored in address comparison

Table 79 - HDLC Address Recognition Register1 (Page 0BH & 0CH, Address 10H)

Bit	Name	Functional Description
7 - 1	Ad26 - Ad20	A seven bit mask used to interrogate the second byte of the received address. Adr26 is MSB. This mask is ignored (as well as first byte mask) if all call address (1111111) is received.
0	A2en	When this bit is one, this seven bit mask is used in address comparison of the second address byte. If address recognition is enabled, any packet failing the address comparison will not be stored in the Rx FIFO. A2en must be one for All-call address recognition. When this bit is zero, this bit mask is ignored in address comparison

Table 80 - HDLC Address Recognition Register 2 (Pages 0BH & 0CH, Address 11H)

Bit	Name	Functional Description
7 - 0	Bit7 - Bit0	This eight bit word is tagged with the two status bits (EOP and FA) from the Control Register 1, and the resulting 10 bit word is written to the TX FIFO. The FIFO status is not changed immediately after a write or read occurs. It is updated after the data and the read/write pointers have settled.

Table 81 - TX FIFO Write Register (Pages 0BH & 0CH, Address 12H)

Bit	Name	Functional Description
7 - 0	Bit7 - Bit0	This is the received data byte read from the RX FIFO. The status bits of this byte can be read from the status register. The FIFO status is not changed immediately when a write or read occurs. It is updated after the data and the read/write pointers have settled.

Table 82 - RX FIFO Read Register (Pages 0BH & 0CH, Address 12H)

Bit	Name	Functional Description
7	Adrec	Address Recognition. When one this bit will enable address recognition. This forces the receiver to recognize only those packets having the unique address as programmed in the Receive Address Recognition Registers or if the address is an All call address.
6	RxEN	Receive Enable. When one the receiver will be immediately enabled and will begin searching for flags, Go-Aheads etc. When zero this bit will disable the HDLC receiver after the rest of the packet presently being received is finished. The receiver internal clock is disabled.
5	TxEN	Transmit Enable. When one the transmitter will be immediately enabled and will begin transmitting data, if any, or go to a mark idle or interframe time fill state. When zero this bit will disable the HDLC transmitter after the completion of the packet presently being transmitted. The transmitter internal clock is disabled.
4	EOP	End Of Packet. Forms a tag on the next byte written the TX FIFO, and when set will indicate an end of packet byte to the transmitter, which will transmit an FCS following this byte. This facilitates loading of multiple packets into TX FIFO. Reset automatically after a write to the TX FIFO occurs.
3	FA	Frame Abort. Forms a tag on the next byte written to the TX FIFO, and when set to one FA will indicate to the transmitter that it should abort the packet in which that byte is being transmitted. Reset automatically after a write to the TX FIFO.

Table 83 - HDLC Control Register 1 (Page 0BH & 0CH, Address 13H) (continued)

Bit	Name	Functional Description
2	Mark-Idle	When zero, the transmitter will be in an idle state. When one it is in an interframe time fill state. These two states will only occur when the TX FIFO is empty.
1-0	RSV	Reserved: Must be set to 0 for normal operation.

Table 83 - HDLC Control Register 1 (Page 0BH & 0CH, Address 13H)

Bit	Name	Functional Description															
7	Intgen	Interrupt Generation. Intgen is set to 1 when an interrupt (in conjunction with the Interrupt Mask Register) has been generated by the HDLC. This is an asynchronous event. It is reset when the Interrupt Register is read.															
6	Idle Chan	Idle Channel. This bit is set to a 1 when an idle Channel state (15 or more ones) has been detected at the receiver. This is an asynchronous event. Status becomes valid after the first 15 bits or the first zero is received.															
5, 4	RQ9, RQ8	Byte Status bits from RX FIFO. These bits determine the status of the byte to be read from RX FIFO as follows: <table border="1" style="margin-left: 20px;"> <thead> <tr> <th>RQ9</th> <th>RQ8</th> <th>Byte Status</th> </tr> </thead> <tbody> <tr> <td>0</td> <td>0</td> <td>Packet byte.</td> </tr> <tr> <td>0</td> <td>1</td> <td>First byte.</td> </tr> <tr> <td>1</td> <td>0</td> <td>Last byte of a good packet.</td> </tr> <tr> <td>1</td> <td>1</td> <td>Last byte of a bad packet.</td> </tr> </tbody> </table>	RQ9	RQ8	Byte Status	0	0	Packet byte.	0	1	First byte.	1	0	Last byte of a good packet.	1	1	Last byte of a bad packet.
RQ9	RQ8	Byte Status															
0	0	Packet byte.															
0	1	First byte.															
1	0	Last byte of a good packet.															
1	1	Last byte of a bad packet.															

Table 84 - HDLC Status Register (Pages 0BH & 0CH, Address 14H) (Continued)

Bit	Name	Functional Description		
3, 2	Txstat2, Txstat1	Transmit Status. These bits indicate the status of the TX FIFO as follows:		
		Txsta t2	Txsta t1	TX FIFO Status
		0	0	TX FIFO full up to the selected status level or more. See Table 93.
		0	1	The number of bytes in the TX FIFO has reached or exceeded the selected interrupt threshold level. See Table 94.
		1	0	TX FIFO empty.
	1	1	The number of bytes in the TX FIFO is less than the selected interrupt threshold level. See Table 94.	
1, 0	Rxstat2, Rxstat1	Receive Status. These bits indicate the status of the RX FIFO as follows:		
		Rxsta t2	Rxsta t1	RX FIFO Status
		0	0	RX FIFO empty.
		0	1	The number of bytes in the RX FIFO is less than the selected threshold level. See Table 94.
		1	0	RX FIFO full up to the selected status level or more. See Table 93.
	1	1	The number of bytes in the RX FIFO has reached or exceeded the selected interrupt threshold level. See Table 94.	

**Table 84 - HDLC Status Register
(Pages 0BH & 0CH, Address 14H)**

Bit	Name	Functional Description
7	Intsel	Interrupt Selection. When one, this bit will cause bit 2 of the Interrupt Register to reflect a TX FIFO underrun (TXunder). When zero, this interrupt will reflect a frame abort (FA).
6	Cycle	When one, this bit will cause the transmit byte count to cycle through the value loaded into the Transmit Byte Count Register.
5	Tcrcl	Transmit CRC Inhibited. When one, this bit will inhibit transmission of the CRC. That is, the transmitter will not insert the computed CRC onto the bit stream after seeing the EOP tag byte. This is used in V.120 terminal adaptation for synchronous protocol sensitive UI frames.
4	Seven	Seven Bits Address Recognition. When one, this bit will enable seven bits of address recognition in the first address byte. The received address byte must have bit 0 equal to 1 which indicates a single address byte is being received.
3	RSV	Reserved, must be zero for normal operation.
2	RSV	Reserved, must be zero for normal operation.
1	Rxfrst	RX FIFO Reset. When one, the RX FIFO will be reset. This causes the receiver to be disabled until the next reception of a flag. The status register will identify the FIFO as being empty. However, the actual bit values in the RX FIFO will not be reset.
0	Txfrst	TX FIFO Reset. When one, the TX FIFO will be reset. The Status Register will identify the FIFO as being empty. This bit will be reset when data is written to the TX FIFO. However, the actual bit values of data in the TX FIFO will not be reset. It is cleared by the next write to the TX FIFO.

**Table 85 - HDLC Control Register 2
(Pages 0BH & 0CH, Address 15H)**

Bit	Name	Functional Description
7-0	Ga, EOPD, TEOP, EOPR, TxFl, FA: Txunder, RxFf & RxOvfl	This register is used with the Interrupt Register to mask out the interrupts that are not required by the microprocessor. Interrupts that are masked out will not produce an \overline{IRQ} ; however, they will set the appropriate bit in the Interrupt Register. An interrupt is disabled when the microprocessor writes a 0 to a bit in this register. This register is cleared on power reset.

Table 86 - HDLC Interrupt Mask Register (Pages 0BH & 0CH, Address 16H)

Bit	Name	Functional Description
7	GA	Go-Ahead. Indicates a go-ahead pattern was detected by the HDLC receiver. This bit is reset after a read.
6	EOPD	End Of Packet Detect. This bit is set to one when an end of packet (EOP) byte was written into the RX FIFO by the HDLC receiver. This can be in the form of a flag, an abort sequence or as an invalid packet. This bit is reset after a read.
5	TEOP	Transmit End Of Packet. This bit is set to one when the transmitter has finished sending the closing flag of a packet or after a packet has been aborted. This bit is reset after read.
4	EOPR	End Of Packet Read. This bit is set to one when the byte about to be read from the RX FIFO is the last byte of the packet. It is also set to one if the Rx FIFO is read and there is no data in it. This bit is reset after a read.
3	TxFL	TX FIFO Low. This bit is set to one when the TX FIFO is emptied below the selected low threshold level. This bit is reset after a read.

Table 87 - HDLC Interrupt Status Register (Page 0BH & 0CH, Address 17H) (continued)

Bit	Name	Functional Description
2	FA: Txunder	Frame Abort/TX FIFO Underrun. When Intsel bit of Control Register 2 is low, this bit is set to one when a frame abort is received during packet reception. It must be received after a minimum number of bits have been received (26) otherwise it is ignored. When Intsel bit of Control Register 2 is one, this bit is set to one for a TX FIFO underrun indication. If one it indicates that a read by the transmitter was attempted on an empty Tx FIFO. This bit is reset after a read.
1	RxFf	RX FIFO Full. This bit is set to one when the RX FIFO is filled above the selected full threshold level. This bit is reset after a read.
0	RxOvfl	RX FIFO Overflow. A one indicates that the 128 byte RX FIFO overflowed (i.e. an attempt to write to a 128 byte full RX FIFO). The HDLC will always disable the receiver once the receive overflow has been detected. The receiver will be re-enabled upon detection of the next flag, but will overflow again unless the RX FIFO is read. This bit is reset after a read.

Table 87 - HDLC Interrupt Status Register (Page 0BH & 0CH, Address 17H)

Bit	Name	Functional Description
7 - 0	Crc15-8	The MSB byte of the CRC received from the transmitter. These bits are as the transmitter sent them; that is, most significant bit first and inverted. This register is updated at the end of each received packet and therefore should be read when end of packet is detected.

Table 88 - Receive CRC MSB Register (Pages 0BH & 0CH, Address 18H)

Bit	Name	Functional Description
7 - 0	Crc7 - 0	The LSB byte of the CRC received from the transmitter. These bits are as the transmitter sent them; that is, most significant bit first and inverted. This register is updated at the end of each received packet and therefore should be read when end of packet is detected.

Table 89 - Receive CRC LSB Register (Pages 0BH & 0CH, Address 19H)

Bit	Name	Functional Description
7 - 0	Cnt7 - 0	The Transmit Byte Count Register. It is used to indicate the length of the packet about to be transmitted. When this register reaches the count of one, the next write to the Tx FIFO will be tagged as an end of packet byte. The counter decrements at the end of the write to the Tx FIFO. If the Cycle bit of Control Register 2 is set high, the counter will cycle through the programmed value continuously.

Table 90 - Transmit Byte Count register (Pages B & C, Address 1AH)

Bit	Name	Functional Description
7	HRST	HDLC Reset. When this bit is set to one, the HDLC will be reset. This is similar to RESET being applied, the only difference being that this bit will not be reset automatically. This bit can only be reset by writing a zero <u>twice</u> to this location or applying RESET.

Table 91 - HDLC Test Control Register (Pages 0BH & 0CH, Address 1BH) (continued)

Bit	Name	Functional Description
6	RTloop	RT Loopback. When this bit is set to one, receive to transmit HDLC loopback will be activated. Receive data, including end of packet indication, but not including flags or CRC, will be written to the TX FIFO as well as the RX FIFO. When the transmitter is enabled, this data will be transmitted as though written by the microprocessor. Both good and bad packets will be looped back. Receive to transmit loopback may also be accomplished by reading the RX FIFO using the microprocessor and writing these bytes, with appropriate tags, into the TX FIFO.
5	RSV	Reserved; must be set to 0 for normal operation.
4	RSV	Reserved; must be set to 0 for normal operation.
3	RSV	Reserved; must be set to 0 for normal operation.
2	Ftst	FIFO Test. This bit when set to one allows the writing to the RX FIFO and reading of the TX FIFO through the microprocessor to allow more efficient testing of the FIFO status/interrupt functionality. This is done by making a TX FIFO write become a RX FIFO write and a RX FIFO read become a TX FIFO read. In addition, EOP/FA and RQ8/RQ9 are re-defined to be accessible (i.e. RX write causes EOP/FA to go to RX fifo input; TX read looks at output of TX FIFO through RQ8/RQ9 bits).
1	RSV	Reserved; must be set to 0 for normal operation.
0	Hloop	TR Loopback. When high, transmit to receive HDLC loopback will be activated. The packetized transmit data will be looped back to the receive input. RxEN and TxEN bits must also be enabled.

Table 91 - HDLC Test Control Register (Pages 0BH & 0CH, Address 1BH)

Bit	Name	Functional Description
7 - 4	RSV	These bits are reserved.
3	RXclk	This bit represents the receiver clock generated after the RXEN control bit is enabled, but before zero deletion is considered.
2	TXclk	This bit represents the transmit clock generated after the TXEN control bit is enabled, but before zero insertion is considered.
1	Vcrc	This is the CRC recognition status bit for the receiver. Data is clocked into the register and then this bit is monitored to see if comparison was successful (bit will be one).
0	Vaddr	This is the address recognition status bit for the receiver. Data is clocked into the Address Recognition Register and then this bit is monitored to see if comparison was successful (bit will be one).

**Table 92 - HDLC Test Status Register
(Page 0BH & 0CH, Address 1CH)**

Bit	Name	Functional Description																																				
7	---	Unused.																																				
6 - 4	RFD2 - 0	These bits select the Rx FIFO full status level:																																				
		<table border="1"> <thead> <tr> <th>RFD2</th> <th>RFD1</th> <th>RFD0</th> <th>Full Status Level</th> </tr> </thead> <tbody> <tr> <td>0</td> <td>0</td> <td>0</td> <td>16</td> </tr> <tr> <td>0</td> <td>0</td> <td>1</td> <td>32</td> </tr> <tr> <td>0</td> <td>1</td> <td>0</td> <td>48</td> </tr> <tr> <td>0</td> <td>1</td> <td>1</td> <td>64</td> </tr> <tr> <td>1</td> <td>0</td> <td>0</td> <td>80</td> </tr> <tr> <td>1</td> <td>0</td> <td>1</td> <td>96</td> </tr> <tr> <td>1</td> <td>1</td> <td>0</td> <td>112</td> </tr> <tr> <td>1</td> <td>1</td> <td>1</td> <td>128</td> </tr> </tbody> </table>	RFD2	RFD1	RFD0	Full Status Level	0	0	0	16	0	0	1	32	0	1	0	48	0	1	1	64	1	0	0	80	1	0	1	96	1	1	0	112	1	1	1	128
		RFD2	RFD1	RFD0	Full Status Level																																	
		0	0	0	16																																	
		0	0	1	32																																	
		0	1	0	48																																	
		0	1	1	64																																	
		1	0	0	80																																	
		1	0	1	96																																	
1	1	0	112																																			
1	1	1	128																																			
3	---	Unused.																																				
2 - 0	TFD2 - 0	These bits select the Tx HDLC FIFO full status level:																																				
		<table border="1"> <thead> <tr> <th>TFD2</th> <th>TFD1</th> <th>TFD0</th> <th>Full Status Level</th> </tr> </thead> <tbody> <tr> <td>0</td> <td>0</td> <td>0</td> <td>16</td> </tr> <tr> <td>0</td> <td>0</td> <td>1</td> <td>32</td> </tr> <tr> <td>0</td> <td>1</td> <td>0</td> <td>48</td> </tr> <tr> <td>0</td> <td>1</td> <td>1</td> <td>64</td> </tr> <tr> <td>1</td> <td>0</td> <td>0</td> <td>80</td> </tr> <tr> <td>1</td> <td>0</td> <td>1</td> <td>96</td> </tr> <tr> <td>1</td> <td>1</td> <td>0</td> <td>112</td> </tr> <tr> <td>1</td> <td>1</td> <td>1</td> <td>128</td> </tr> </tbody> </table>	TFD2	TFD1	TFD0	Full Status Level	0	0	0	16	0	0	1	32	0	1	0	48	0	1	1	64	1	0	0	80	1	0	1	96	1	1	0	112	1	1	1	128
		TFD2	TFD1	TFD0	Full Status Level																																	
		0	0	0	16																																	
		0	0	1	32																																	
		0	1	0	48																																	
		0	1	1	64																																	
		1	0	0	80																																	
		1	0	1	96																																	
1	1	0	112																																			
1	1	1	128																																			

**Table 93 - HDLC Control Register 3
(Pages 0BH & 0CH, Address 1DH)**

Bit	Name	Functional Description			
7	---	Unused.			
6 - 4	RFFS2 - 0	These bits select the RXFF (Rx FIFO Full) interrupt threshold level:			
		RFFS 2	RFFS 1	RFFS 0	RX FIFO Full Interrupt threshold Level.
		0	0	0	64
		0	0	1	72
		0	1	0	80
		0	1	1	88
		1	0	0	96
		1	0	1	104
		1	1	0	112
		1	1	1	120
3	---	Unused.			
2 - 0	TFLS2 - 0	These bits select the TXFL (Tx FIFO Low) interrupt threshold level:			
		TFLS 2	TFLS 1	TFLS 0	TX FIFO Low Interrupt threshold Level.
		0	0	0	8
		0	0	1	16
		0	1	0	24
		0	1	1	32
		1	0	0	40
		1	0	1	48
		1	1	0	56
1	1	1	64		

**Table 94 - HDLC Control Register 4
(Pages 0BH & 0CH, Address 1EH)**

Transmit National Bit Buffer (Page 0DH)

Page 0DH, addresses 10H to 14H contain the five bytes of the transmit national bit buffer (TNBB0 - TNBB4 respectively). This feature is functional only when control bit NBTB (page 01H, address 10H) is one.

Bit	Name	Functional Description
7 - 0	TNBBn.F1 - TNBBn.F15	Transmit S_{an+4} Bits Frames 1 to 15. This byte contains the bits transmitted in bit position n+4 of channel zero of frames 1, 3, 5, 7, 9, 11, 13 and 15 when CRC-4 multiframe alignment is used, or of consecutive odd frames when CRC-4 multiframe alignment is not used. n = 0 to 4 inclusive and corresponds to a byte of the receive national bit buffer.

Table 95 - Transmit National Bit Buffer Bytes Zero to Four (Page 0DH)

Receive National Bit Buffer (Page 0EH)

Page 0EH, addresses 10H to 14H contain the five bytes of the receive national bit buffer (RNBB0 - RNBB4 respectively).

Bit	Name	Functional Description
7 - 0	RNBBn.F1 - RNBBn.F15	Receive S_{an+4} Bits Frames 1 to 15. This byte contains the bits received in bit position n+4 of channel zero of frames 1, 3, 5, 7, 9, 11, 13 and 15 when CRC-4 multiframe alignment is used, or of consecutive odd frames when CRC-4 multiframe alignment is not used. n = 0 to 4 inclusive and corresponds to a byte of the receive national bit buffer.

Table 96 - Receive National Bit Buffer Bytes Zero to Four (Page 0EH)

Transmit Message Mode Buffer Zero and One (Pages 0FH and 10H)

Pages 0FH and 10H together contain 32 byte storage locations for data that may be transmit onto the equivalent PCM 30 transmit timeslot. Transmission of these bytes is enabled by setting the TXMSG bits (bit 7) in the equivalent Per Time Slot Control Register (page 07H and 08H). Table 97 shows the mapping between the Tx Message Buffer addresses and the equivalent PCM 30 Channels.

Page 0FH (Tx Message Buffer 0) Address:	0	1	2	3	4	5	6	7	8	9	10	11	12	13	14	15
Equivalent PCM 30 Timeslots	0	1	2	3	4	5	6	7	8	9	10	11	12	13	14	15
Page 10H (Tx Message Buffer 1) Address:	0	1	2	3	4	5	6	7	8	9	10	11	12	13	14	15
Equivalent PCM 30 Timeslots	16	17	18	19	20	21	22	23	24	25	26	27	28	29	30	31

Table 97 - Pages 0FH & 10H Address Mapping to CEPT Channels

Page 0FH, addresses 10H to 1FH contain the 16 bytes of transmit message buffer zero

Bit	Name	Functional Description
7 - 0	TxB0.n.7 - TxB0.n.0	Transmit Bits 7 to 0. This byte is transmit on a time slot when selected by the TXMSG bit of the appropriate per time slot control word. n = 0 to 15 and represents transmit timeslot numbers 0 to 15.

Table 98 - Transmit Message Mode Buffer Zero (Page 0FH)

Page 10H, addresses 10H to 1FH contain the 16 bytes of transmit message buffer one

Bit	Name	Functional Description
7 - 0	TxB1.n.7 - TxB1.n.0	Transmit Bits 7 to 0. This byte is transmit on a time slot when selected by the TXMSG bit of the appropriate per time slot control word. n = 0 to 15 and represents transmit timeslot numbers 16 to 31.

Table 99 - Transmit Message Mode Buffer One (Page 10H)

Receive Message Mode Buffer Zero and One (Pages 11H and 12H)

Pages 11H and 12H - Receive Message Buffer 0 and 1 respectively, contain 32 bytes of memory. Each byte is updated once per frame by the equivalent PCM 30 channel from the receive data stream.

Page 0FH (Rx Message Buffer 0) Address:	0	1	2	3	4	5	6	7	8	9	10	11	12	13	14	15
Equivalent PCM 30 Timeslots	0	1	2	3	4	5	6	7	8	9	10	11	12	13	14	15
Page 10H (Rx Message Buffer 1) Address:	0	1	2	3	4	5	6	7	8	9	10	11	12	13	14	15
Equivalent PCM 30 Timeslots	16	17	18	19	20	21	22	23	24	25	26	27	28	29	30	31

Table 100 - Pages 11H & 12H Address Mapping to CEPT Channels

Page 11H, addresses 10H to 1FH contain the 16 bytes of receive message buffer zero

Bit	Name	Functional Description
7 - 0	RxB0.n.7 - RxB0.n.0	Receive Bits 7 to 0. Each byte is sourced from a time slot coming from the line data. n=0 to 15 represents receive timeslots 0 to 15.

Table 101 - Receive Message Buffer Zero (Page 11H)

Page 12H, addresses 10H to 1FH contain the 16 bytes of receive message buffer one

Bit	Name	Functional Description
7 - 0	RxB1.n.7 - RxB1.n.0	Receive Bits 7 to 0. Each byte is sourced from a time slot coming from the line data. n=0 to 15 represents receive timeslots 16 to 31.

Table 102 - Receive Message Buffer One (Page 12H)

Absolute Maximum Ratings* - Voltages are with respect to ground (VSS) unless otherwise stated.

	Parameter	Symbol	Min	Max	Units
1	Supply Voltage	V_{DD}	-0.3	7	V
2	Voltage at Digital Inputs	V_I	-0.3	$V_{DD} + 0.3$	V
3	Current at Digital Inputs	I_I		30	mA
4	Voltage at Digital Outputs	V_O	-0.3	$V_{DD} + 0.3$	V
5	Current at Digital Outputs	I_O		30	mA
6	Storage Temperature	T_{ST}	-55	125	°C

* Exceeding these values may cause permanent damage. Functional operation under these conditions is not implied.

Recommended Operating Conditions - Voltages are with respect to ground (VSS) unless otherwise stated.

	Characteristics	Sym	Min	Typ [‡]	Max	Units	Test Conditions
1	Operating Temperature	T_{OP}	-40		85	°C	
2	Supply Voltage	V_{DD}	4.75	5	5.25	V	

‡ Typical figures are at 25°C and are for design aid only: not guaranteed and not subject to production testing.

DC Electrical Characteristics[†] - Voltages are with respect to ground (VSS) unless otherwise stated.

	Characteristics	Sym	Min	Typ [‡]	Max	Units	Test Conditions
1	Supply Current	I_{DD}			150	mA	Outputs unloaded. Transmitting an all 1's signal.
2	Input High Voltage (Digital Inputs)	V_{IH}	2.0		V_{DD}	V	
3	Input Low Voltage (Digital Inputs)	V_{IL}	0		0.8	V	
4	Input Leakage (Digital Inputs)*	I_{IL}			10	μA	$V_I = 0$ to V_{DD}
5	Output High Voltage (Digital Outputs)	V_{OH}	2.4		V_{DD}	V	$I_{OH}=7$ mA @ $V_{OH}=2.4$ V
6	Output High Current (Digital Outputs)	I_{OH}	10			mA	Source $V_{OH}=2.4$ V
7	Output Low Voltage (Digital Outputs)	V_{OL}	V_{SS}		0.4	V	$I_{OL}=2$ mA @ $V_{OL}=0.4$ V
8	Output Low Current (Digital Outputs)	I_{OL}	10			mA	Sink $V_{OL}=0.4$ V
9	High Impedance Leakage (Digital I/O)	I_{OZ}			10	μA	$V_O = 0$ to V_{DD}

† Characteristics are for clocked operation over the ranges of recommended operating temperature and supply voltage.

‡ Typical figures are at 25°C and are for design aid only: not guaranteed and not subject to production testing.

‡ * Limits for input leakage on pin names: tdi, tck, tms and trstb are max 100uA.

AC Electrical Characteristics - Timing Parameter Measurement Voltage Levels

	Characteristics	Sym	Level	Units	Conditions/Notes
1	TTL Threshold Voltage	V_{TT}	1.5	V	See Note 1
2	CMOS Threshold Voltage	V_{CT}	$0.5 * V_{DD}$	V	See Note 1
3	Rise/Fall Threshold Voltage High	V_{HM}	2.0 $0.7 * V_{DD}$	V V	TTL CMOS
4	Rise/Fall Threshold Voltage Low	V_{LM}	0.8 $0.3 * V_{DD}$	V V	TTL CMOS

Note 1: Timing for output signals is based on the worst case result of the combination of TTL and CMOS thresholds.

AC Electrical Characteristics† - Motorola Microprocessor Timing

	Characteristics	Sym	Min	Typ‡	Max	Units	Test Conditions
1	\overline{DS} low	t_{DSL}	70			ns	
2	\overline{DS} High	t_{DSH}	50			ns	
3	\overline{CS} Setup	t_{CSS}	0			ns	
4	R/ \overline{W} Setup	t_{RWS}	10			ns	
5	Address Setup	t_{ADS}	10			ns	
6	\overline{CS} Hold	t_{CSH}	0			ns	
7	R/ \overline{W} Hold	t_{RWH}	15			ns	
8	Address Hold	t_{ADH}	15			ns	
9	Data Delay Read	t_{DDR}	80			ns	$C_L=50pF, R_L=1k\Omega$
10	Data Hold Read	t_{DHR}	80			ns	$C_L=50pF, R_L=1k\Omega$
11	Data Active to High Z Delay	t_{DAZ}	80			ns	
12	Data Setup Write	t_{DSW}	10			ns	
13	Data Hold Write	t_{DHW}	10			ns	
14	Cycle Time*	t_{CYC}	110			ns	

† Characteristics are for clocked operation over the ranges of recommended operating temperature and supply voltage

‡ Typical figures are at 25°C and are for design aid only; not guaranteed and not subject to production testing.

* This cycle time is for all accesses other than HDLC FIFOs. For HDLC FIFO accesses, a minimum 100ns wait state is required between successive Read/Write operations.

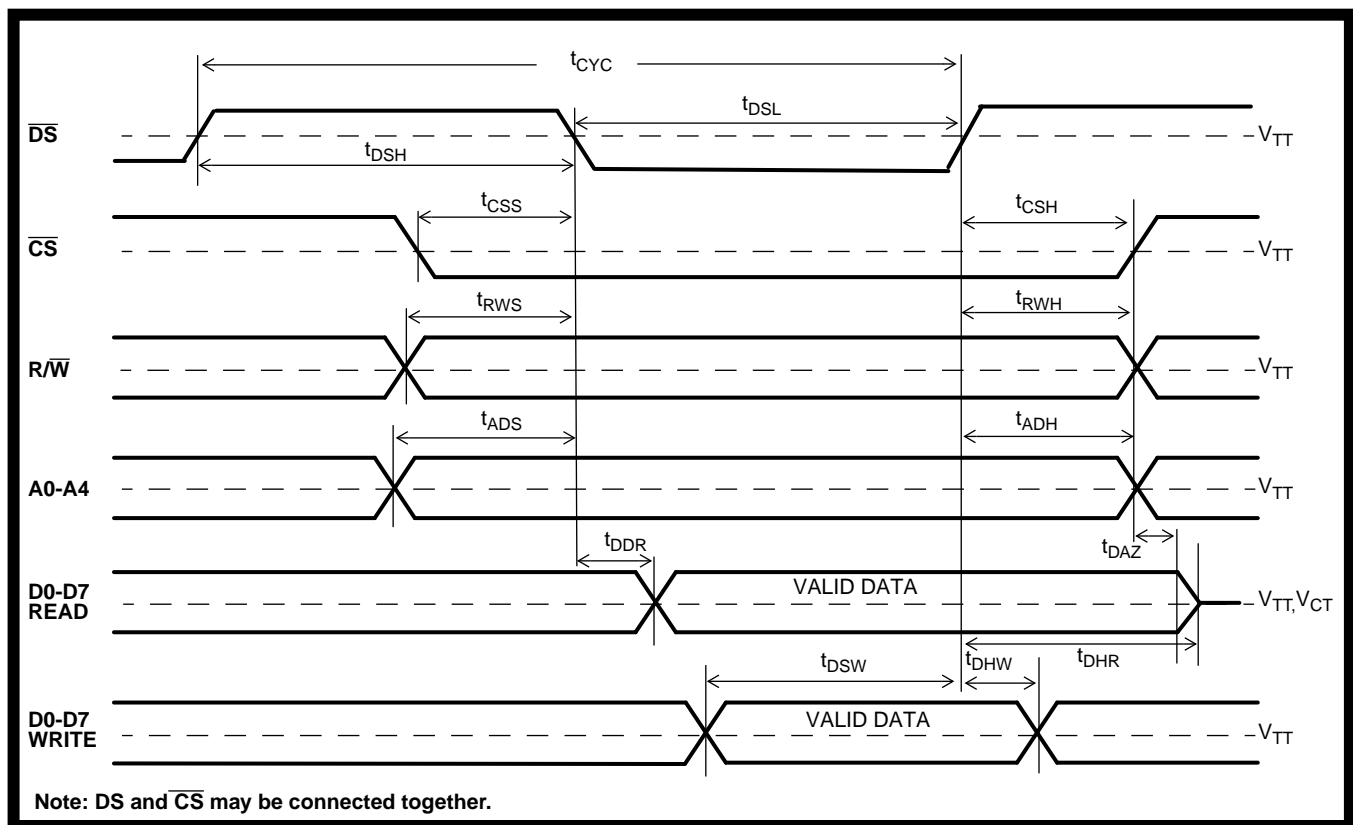

Figure 11 - Motorola Microprocessor Timing

AC Electrical Characteristics† - Intel Microprocessor Timing

	Characteristics	Sym	Min	Typ‡	Max	Units	Test Conditions
1	\overline{RD} low	$t_{RD L}$	60			ns	
2	\overline{RD} High	$t_{RD H}$	50			ns	
3	\overline{CS} Setup	$t_{CS S}$	0			ns	
4	\overline{CS} Hold	$t_{CS H}$	0			ns	
5	Address Setup	$t_{AD S}$	10			ns	
6	Address Hold	$t_{AD H}$	15			ns	
7	Data Delay Read	$t_{DD R}$	80			ns	$C_L=50pF, R_L=1k\Omega$
8	Data Active to High Z Delay	$t_{DA Z}$	80			ns	
9	Data Setup Write	$t_{DS W}$	10			ns	
10	Data Hold Write	$t_{DH W}$	10			ns	
11	Cycle Time*	$t_{CY C}$	110				

† Characteristics are for clocked operation over the ranges of recommended operating temperature and supply voltage

‡ Typical figures are at 25°C and are for design aid only; not guaranteed and not subject to production testing.

* This cycle time is for all accesses other than HDLC FIFOs. For HDLC FIFO accesses, a minimum 100ns wait state is required between successive Read/Write operations.

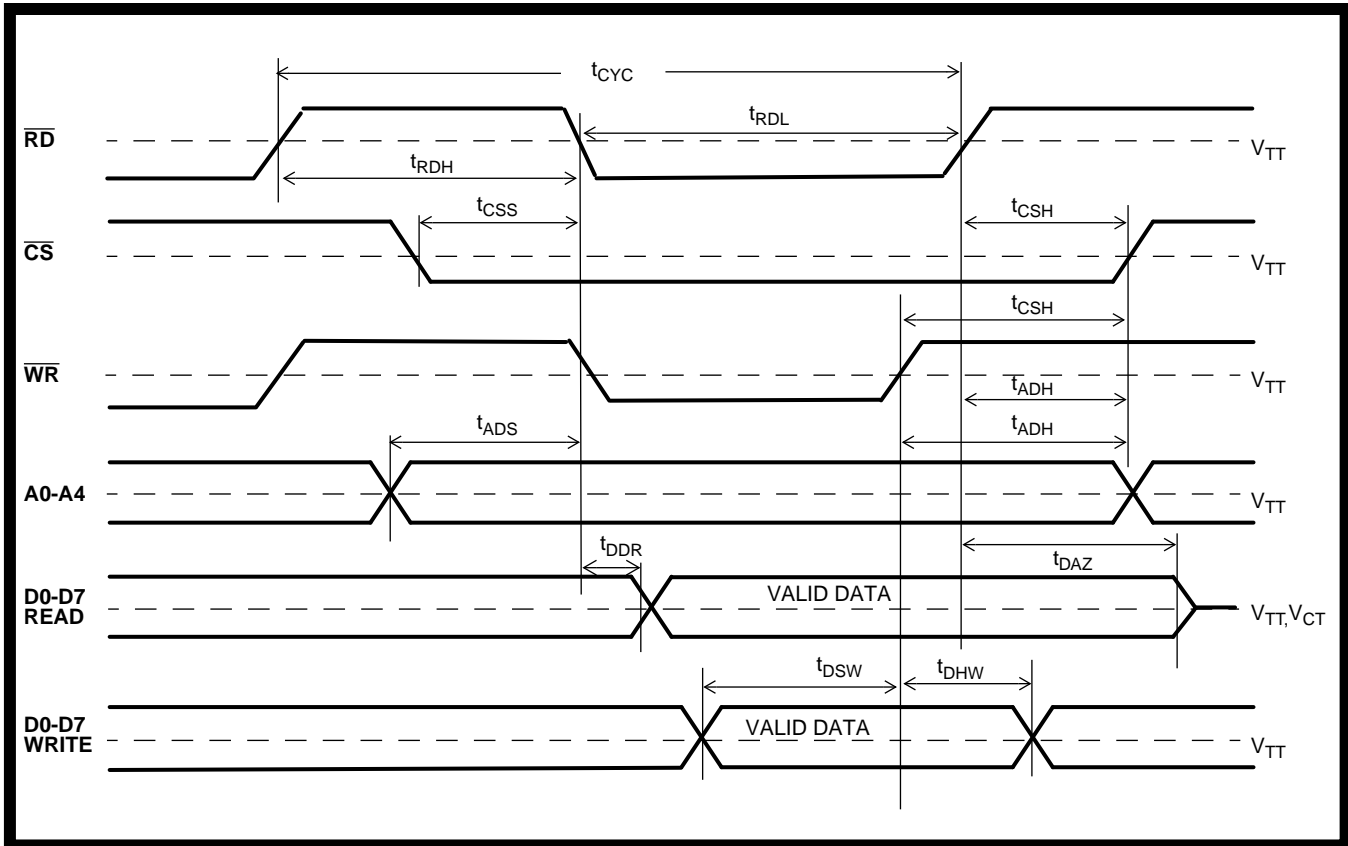

Figure 12 - Intel Microprocessor Timing

AC Electrical Characteristics - Transmit Data Link Timing

	Characteristic	Sym	Min	Typ	Max	Units	Test Conditions
1	Data Link Clock Output Delay	t_{TDC}	35			ns	50pF
2	Data Link Setup	t_{DLS}	10			ns	
3	Data Link Hold	t_{DLH}	10			ns	

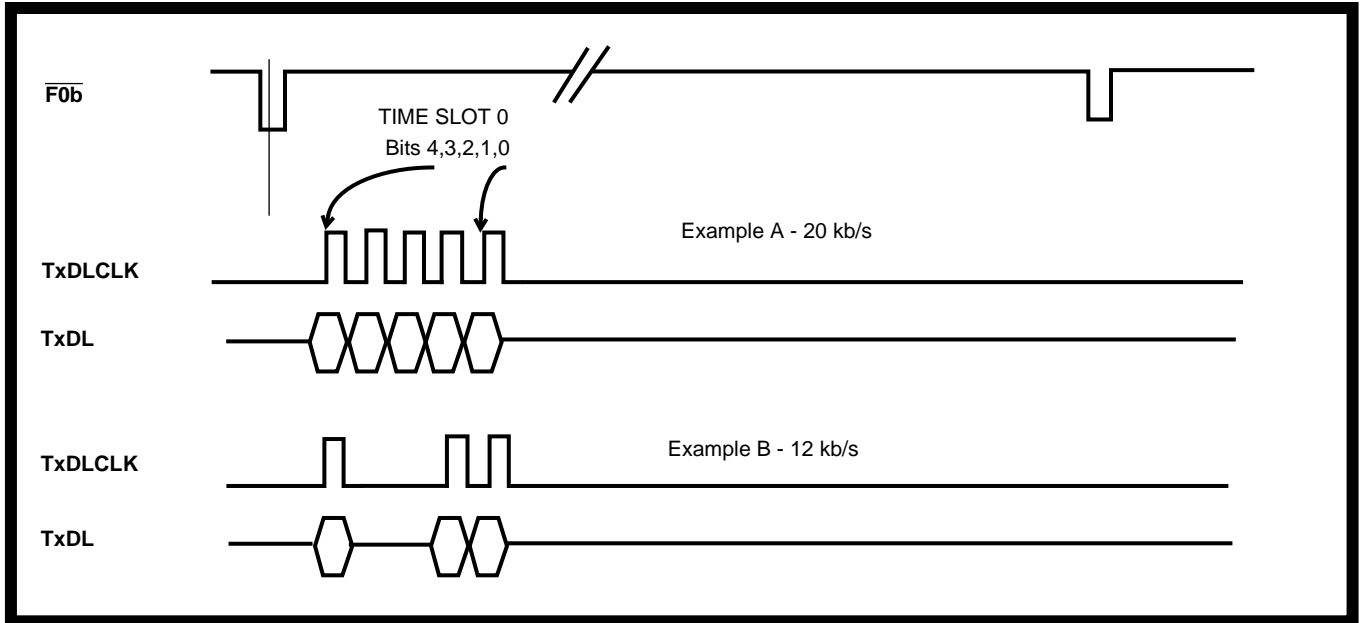

Figure 13 - Transmit Data Link Functional Timing

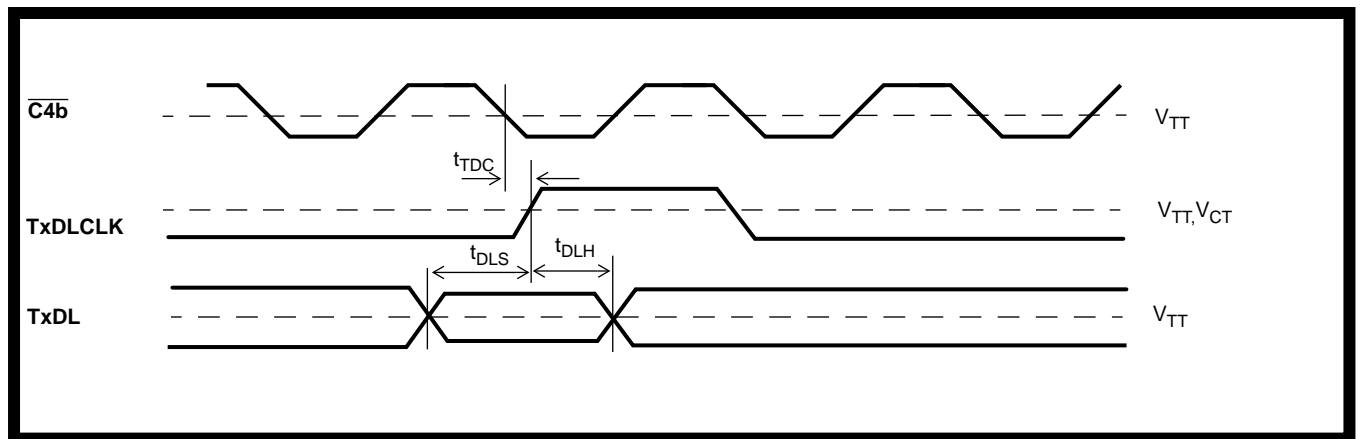

Figure 14 - Transmit Data Link Timing Diagram

AC Electrical Characteristics - Receive Data Link Timing

	Characteristic	Sym	Min	Typ	Max	Units	Test Conditions
1	Data Link Clock Output Delay	t_{RDC}	150			ns	50pF
2	Data Link Output Delay	t_{RDD}	45			ns	50pF

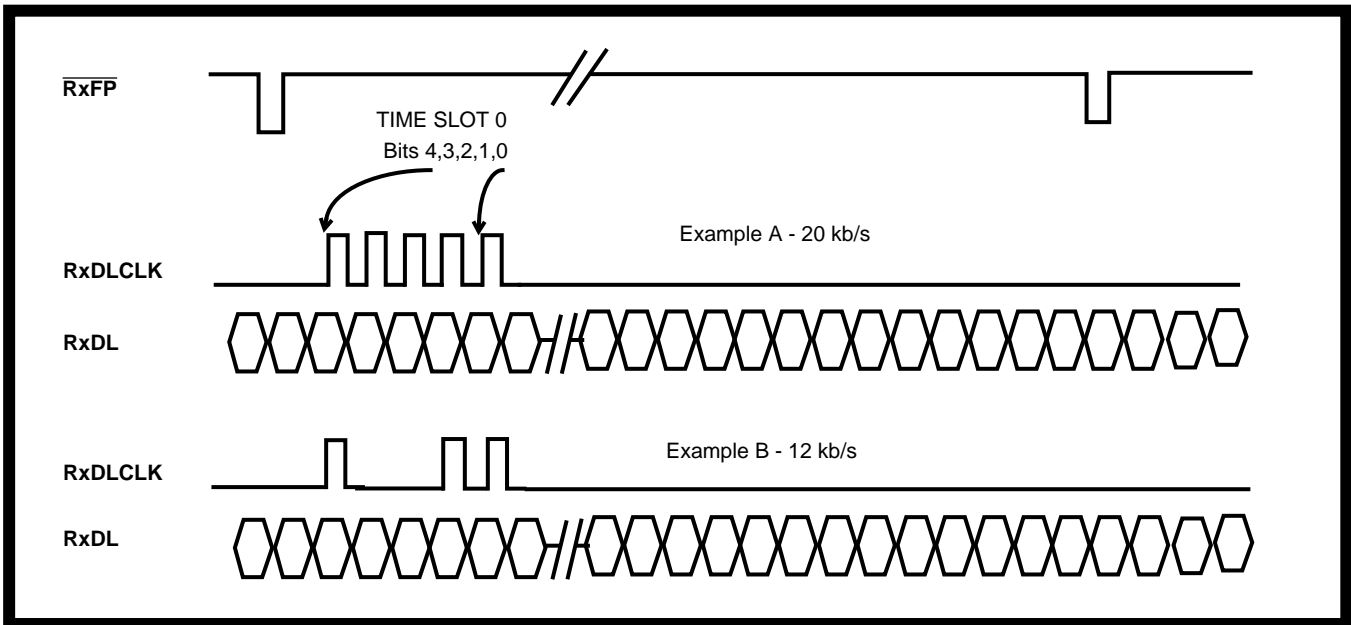

Figure 15 - Receive Data Link Functional Timing

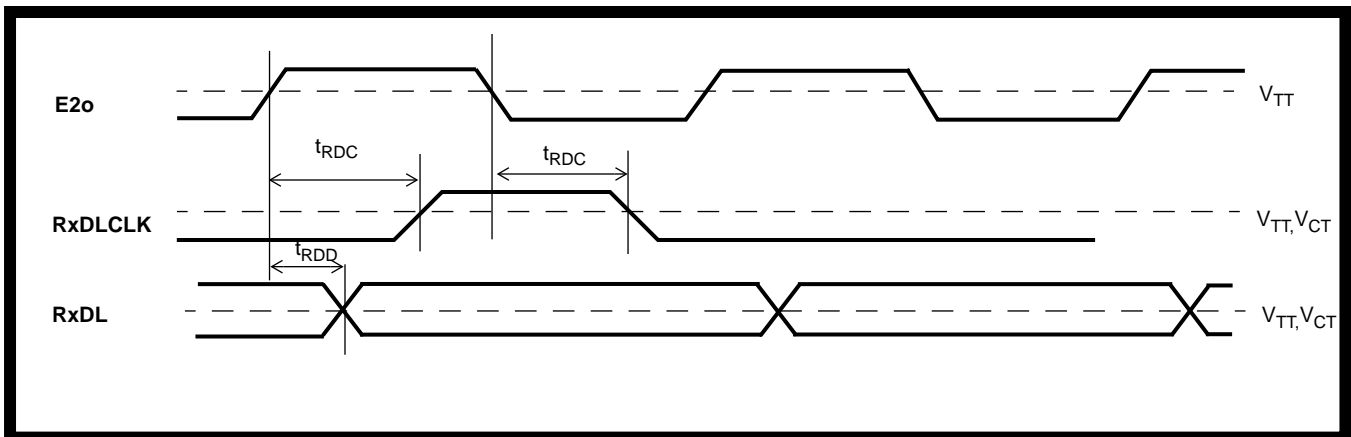

Figure 16 - Receive Data Link Timing Diagram

AC Electrical Characteristics - Transmit 64 k Common Channel Timing

	Characteristic	Sym	Min	Typ	Max	Units	Test Conditions
2	Transmit Common Channel Setup	t_{TCS}	15			ns	
3	Transmit Common Channel Hold	t_{TCH}	15			ns	

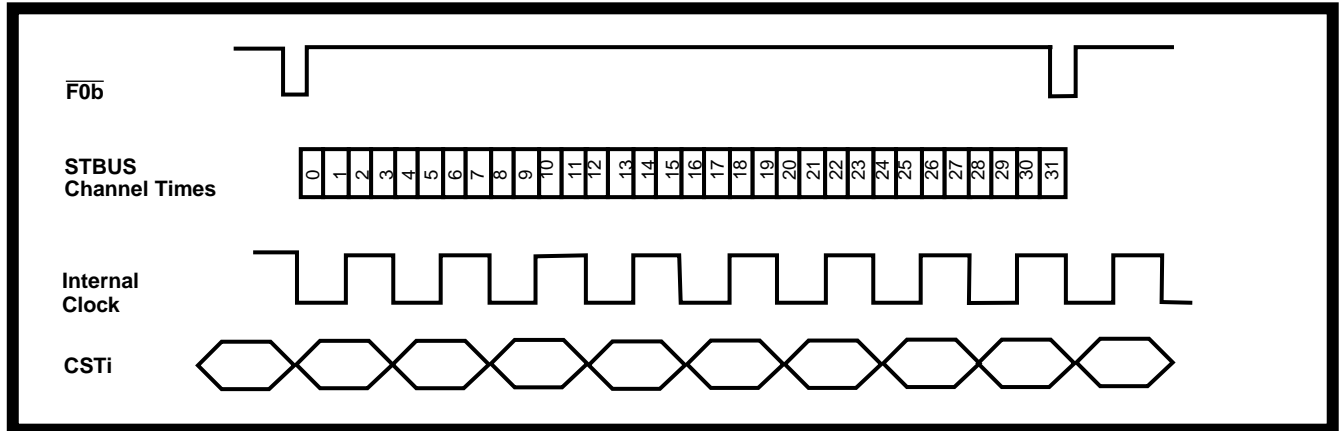

Figure 17 - Transmit 64k Common Channel Functional Timing

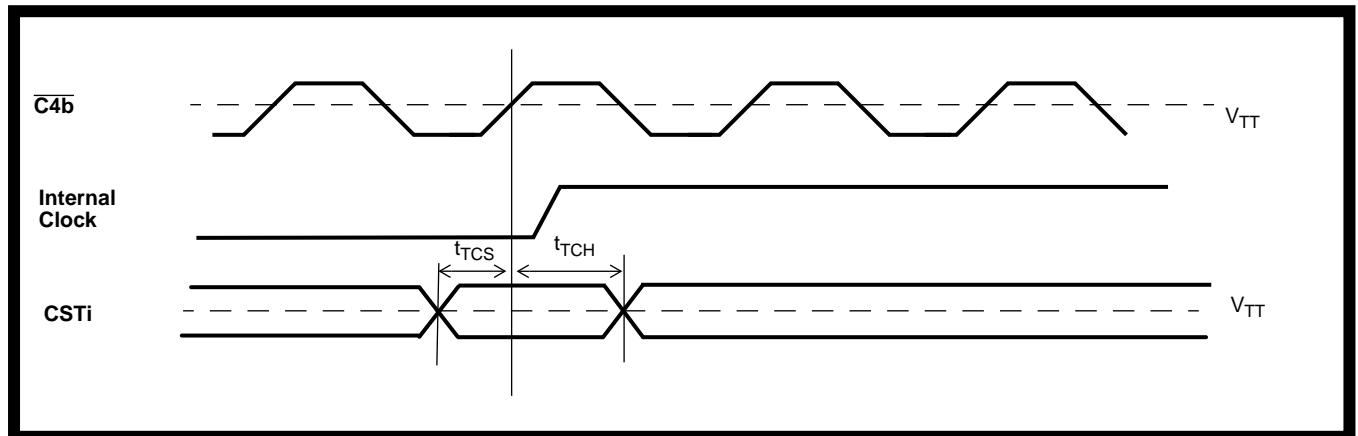

Figure 18 - Transmit 64k Common Channel Timing Diagram

AC Electrical Characteristics - Receive 64k Common Channel Timing

	Characteristic	Sym	Min	Typ	Max	Units	Test Conditions
1	Receive Common Channel Output Delay	t_{RCD}	50			ns	50pF

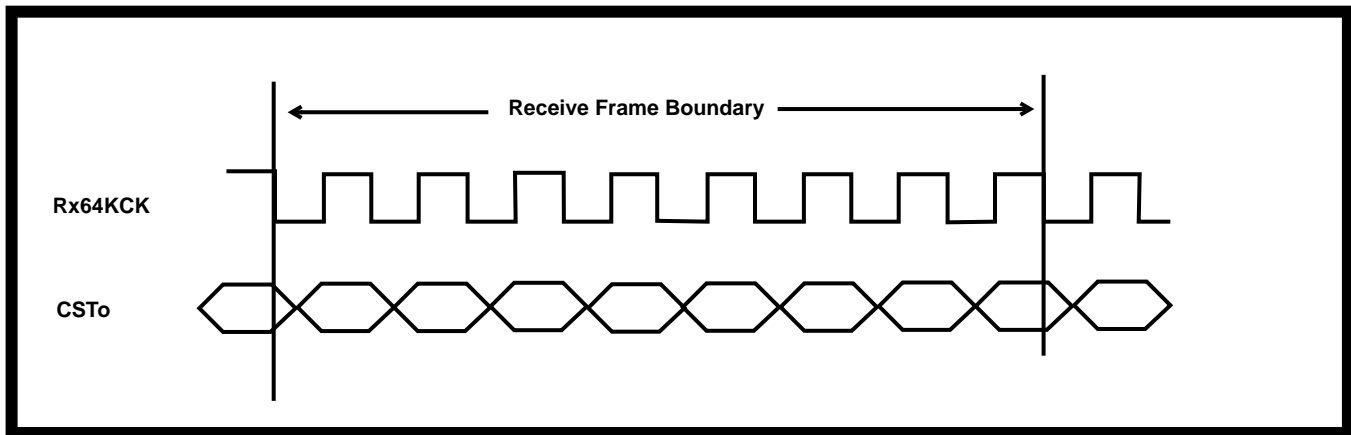

Figure 19 - Receive 64k Common Channel Functional Timing

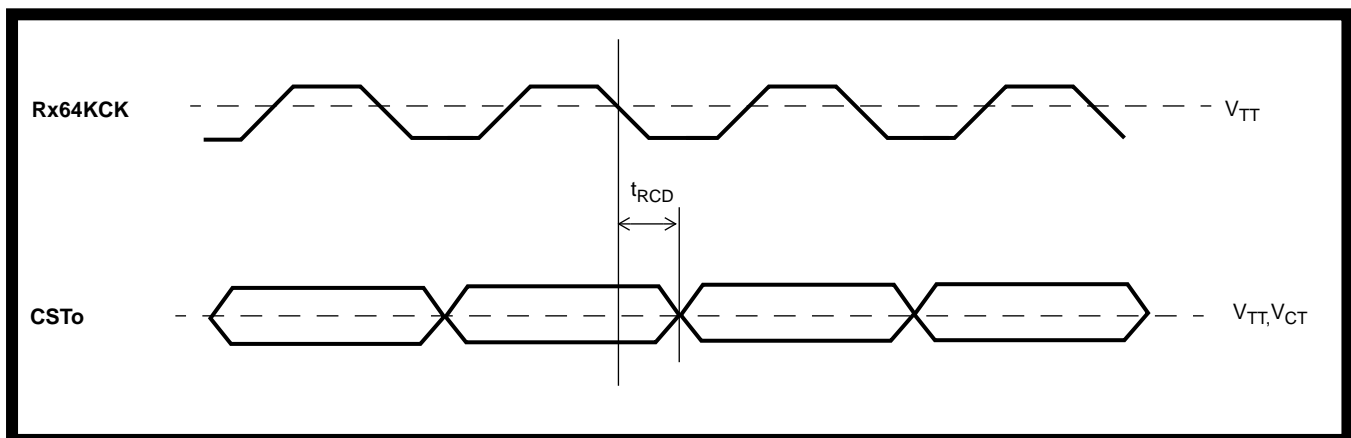

Figure 20 - Receive 64k Common Channel Timing Diagram

AC Electrical Characteristics - ST-BUS / GCI Timing

	Characteristic	Sym	Min	Typ	Max	Units	Test Conditions
1	C4b Clock Width High or Low	t_{4WI}	80		164	ns	C4b as input
2	C4b Clock Width High or Low	t_{4WO}	110		135	ns	C4b as output
3	Frame Pulse Setup	t_{FPS}	10			ns	F0b as input
4	Frame Pulse Hold	t_{FPH}	10			ns	F0b as input
5	Frame Pulse Delay	t_{FPD}	12			ns	F0b as output
6	Serial Input Setup	t_{SIS}	15			ns	
7	Serial Input Hold	t_{SIH}	15			ns	
8	Serial Output Delay	t_{SOD}	50			ns	50pF

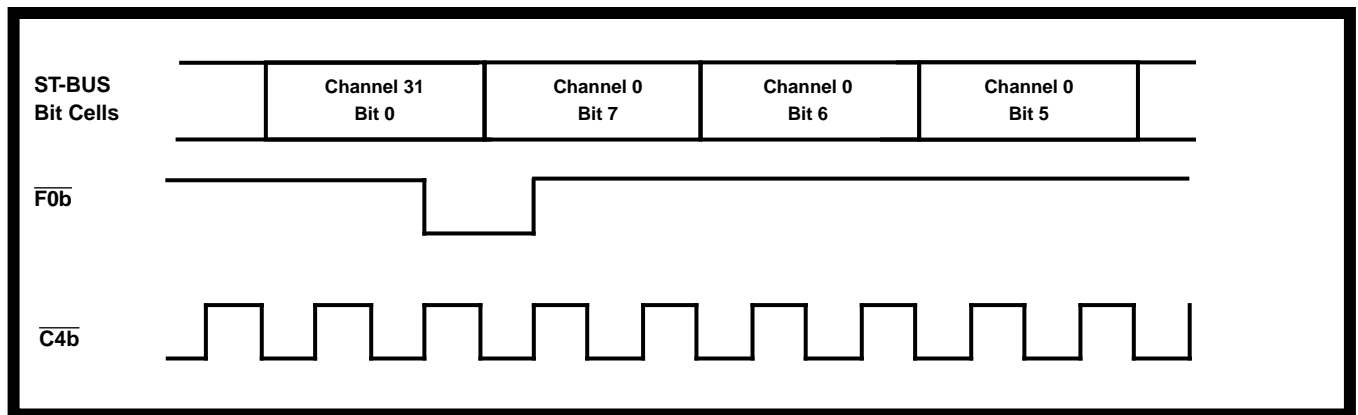

Figure 21 - ST-BUS Functional Timing Diagram

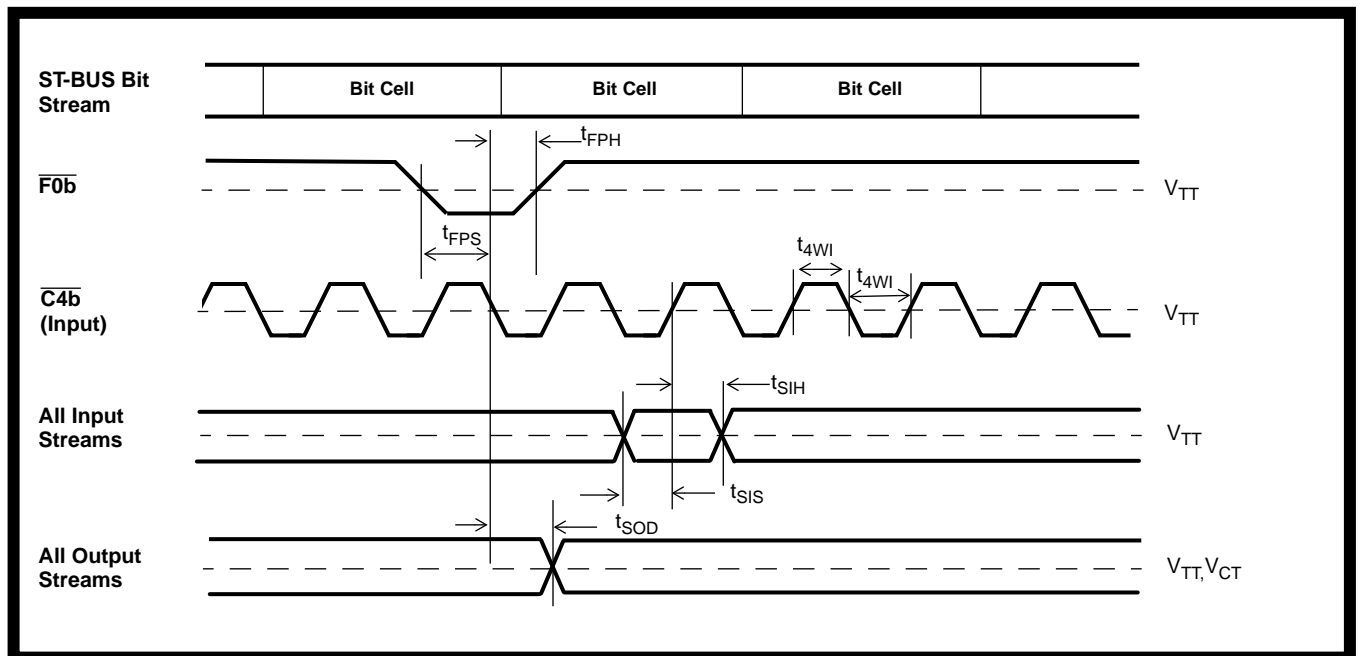

Figure 22 - ST-BUS Timing Diagram

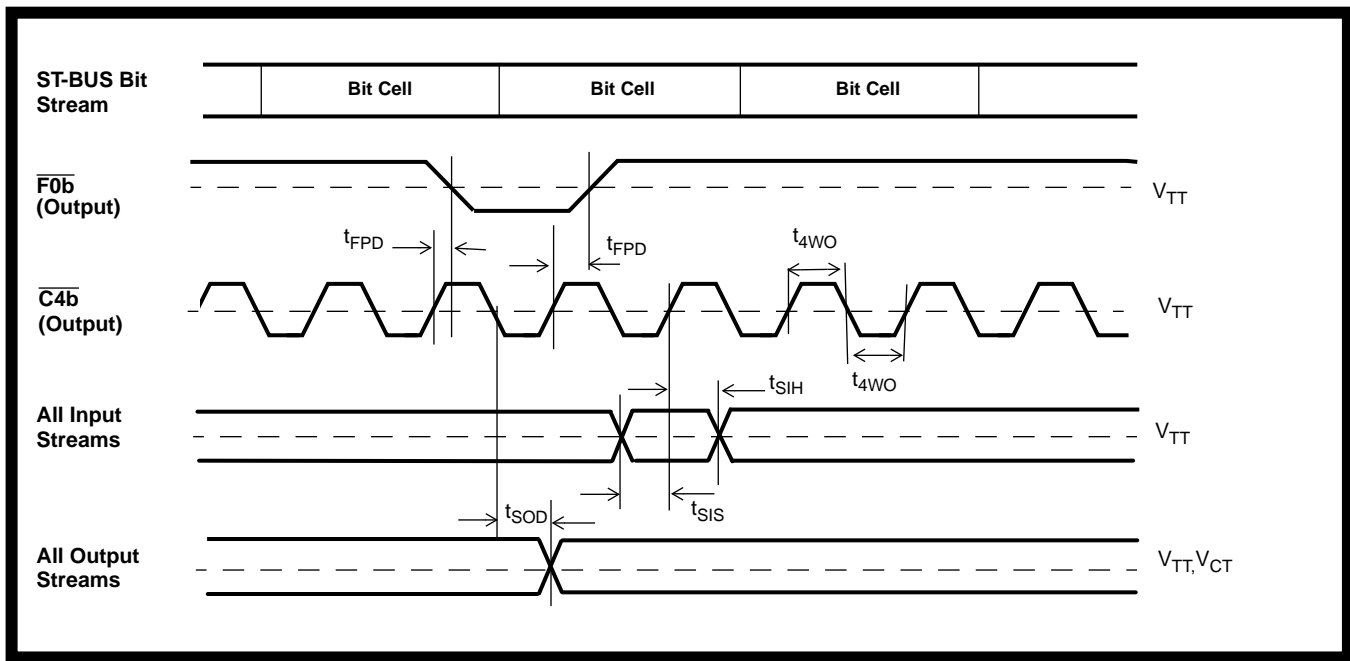

Figure 23 - ST-BUS Timing Diagram (Output Clocks)

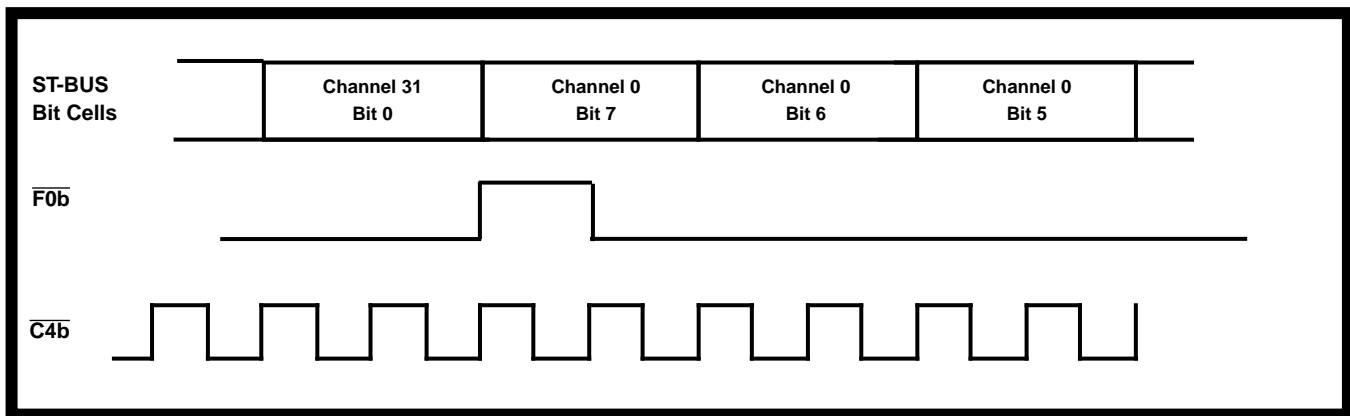

Figure 24 - GCI Functional Timing Diagram

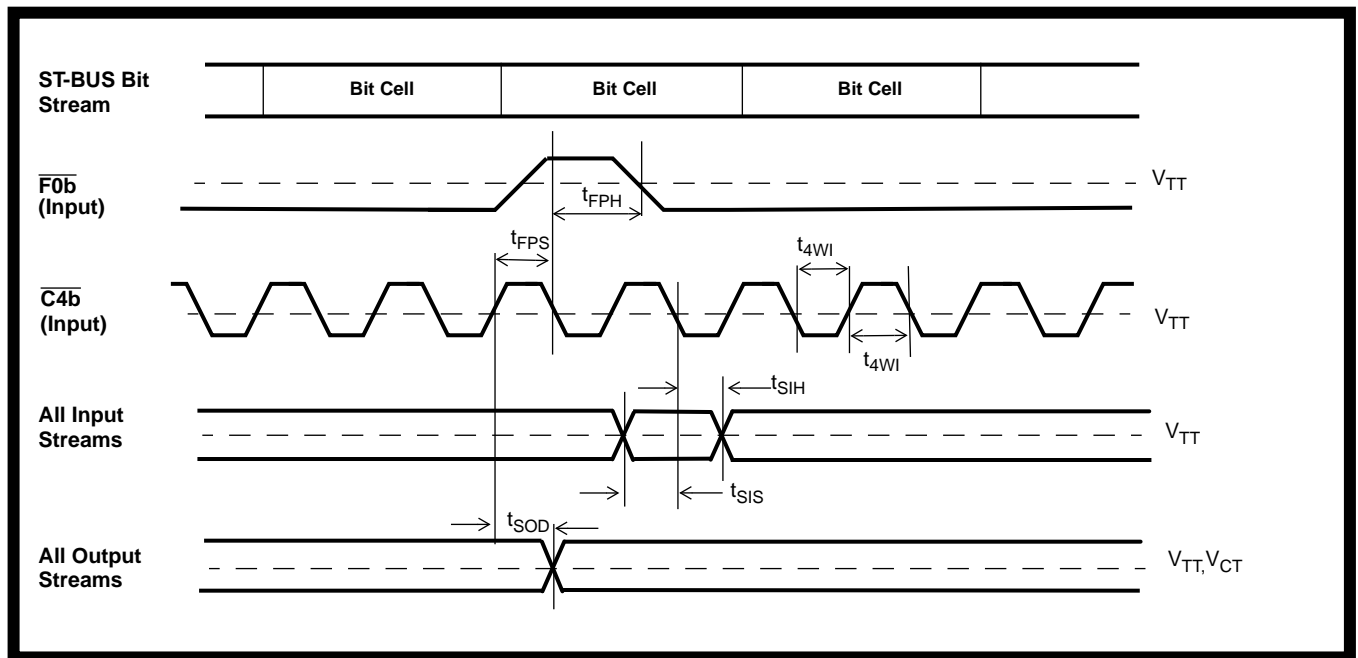

Figure 25 - GCI Timing Diagram (Input Clocks)

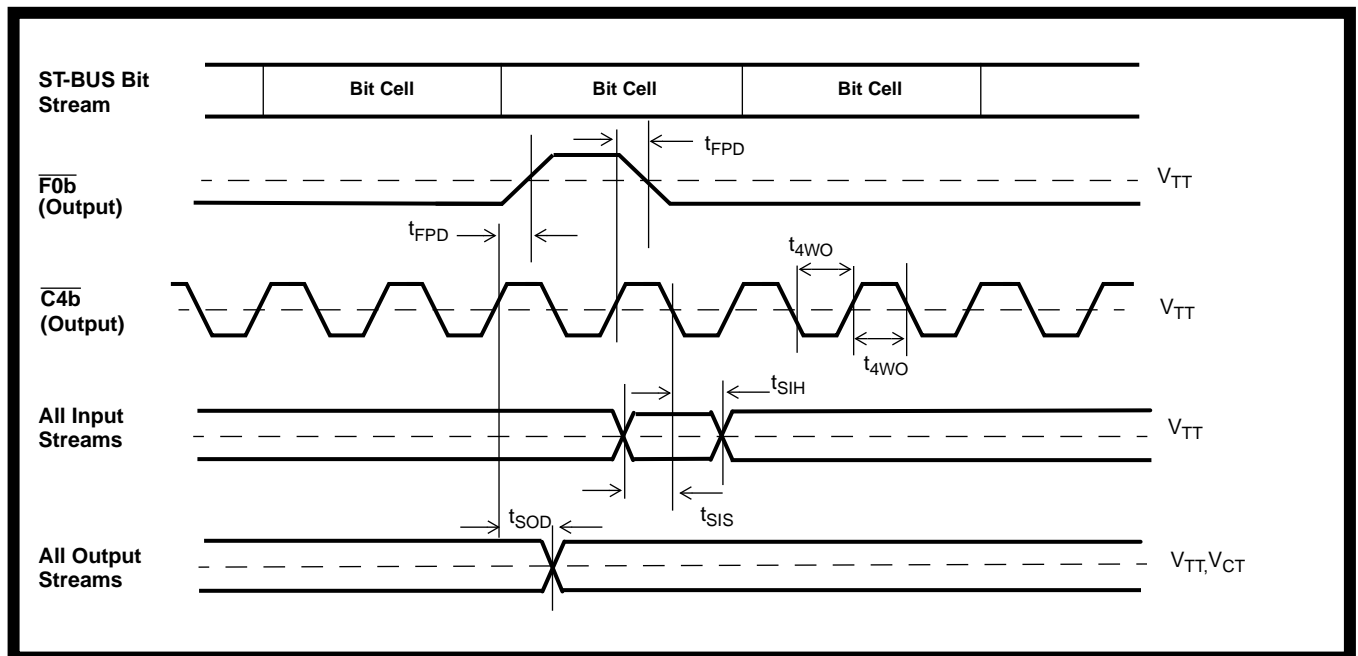

Figure 26 - GCI Timing Diagram (Output Clocks)

AC Electrical Characteristics - Multiframe Timing

	Characteristic	Sym	Min	Typ	Max	Units	Test Conditions
1	Receive Multiframe Output Delay	t_{MOD}	50			ns	50pF
2	Transmit Multiframe Setup	t_{MS}	50			ns	
3	Transmit Multiframe Hold	t_{MH}	50		*	ns	* 256 C2 periods -100nsec

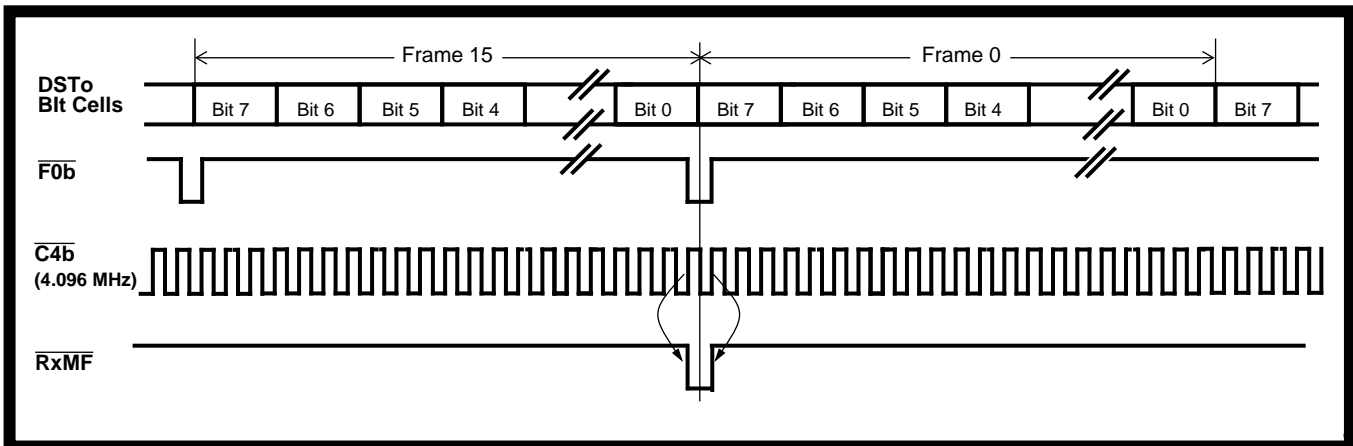

Figure 27 - Receive Multiframe Functional Timing

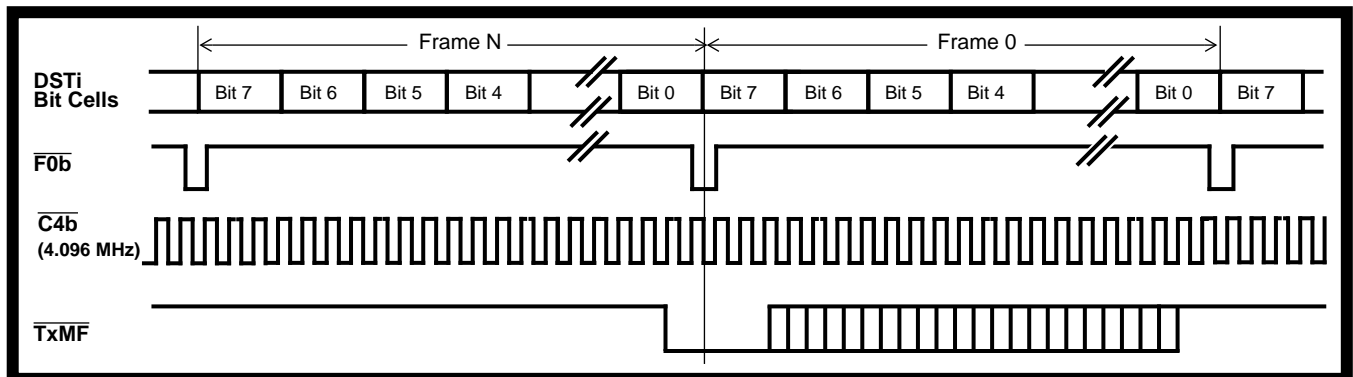

Figure 28 - Transmit Multiframe Functional Timing

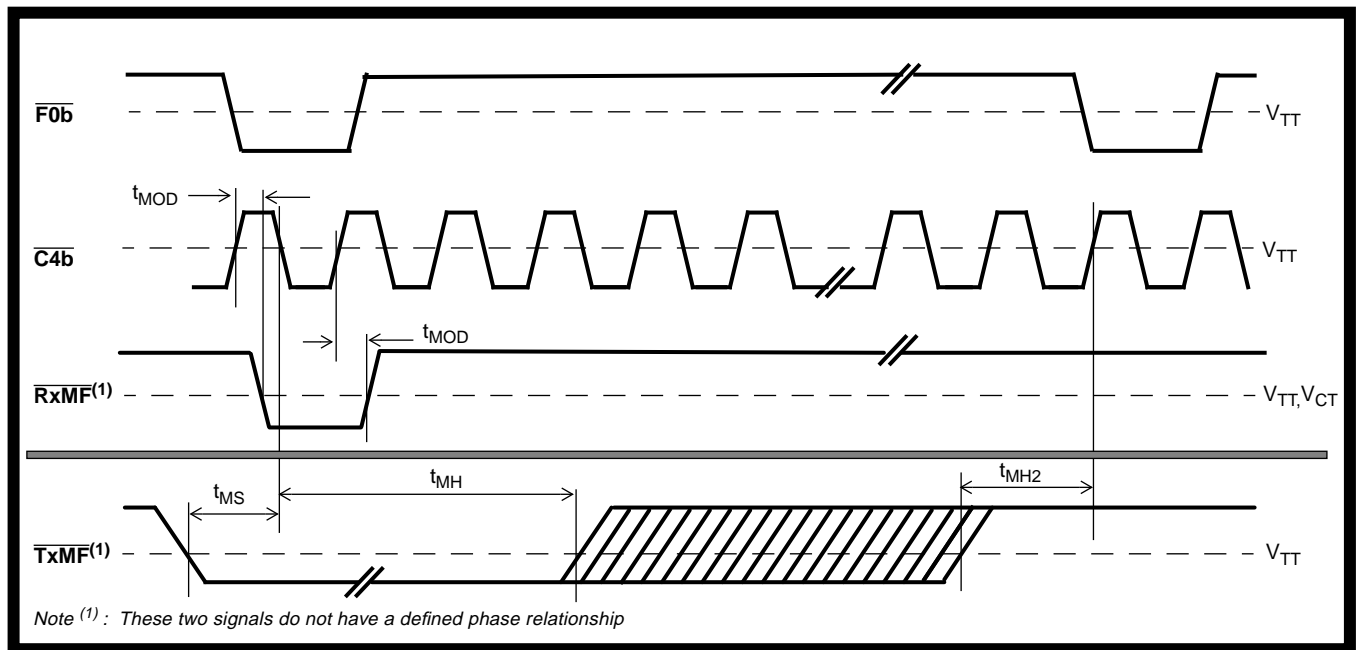

Figure 29 - Multiframe Timing Diagram

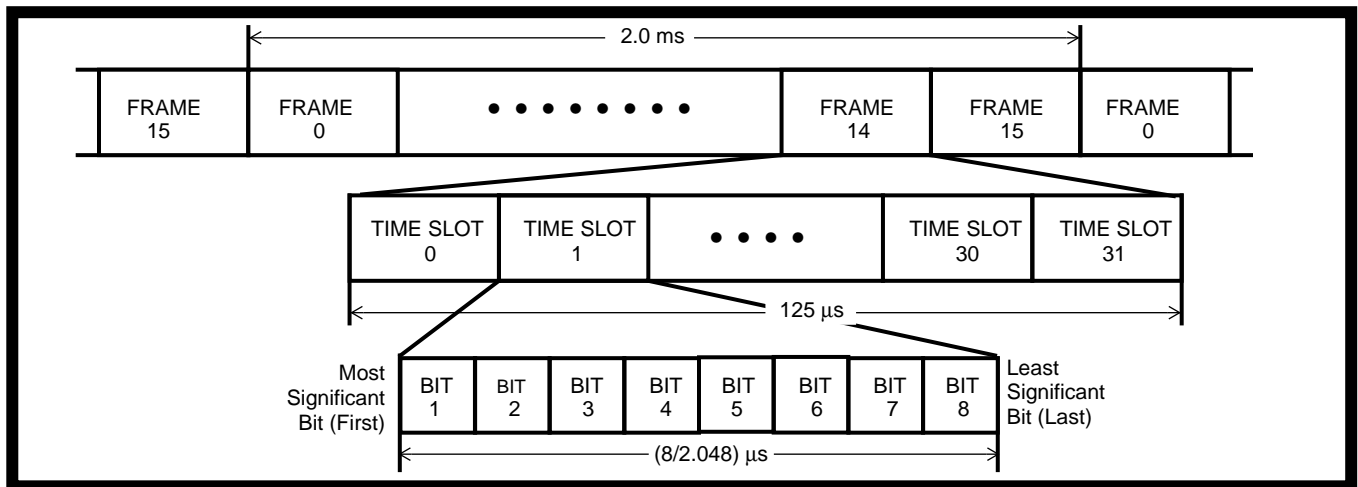

Figure 30 - PCM 30 Format

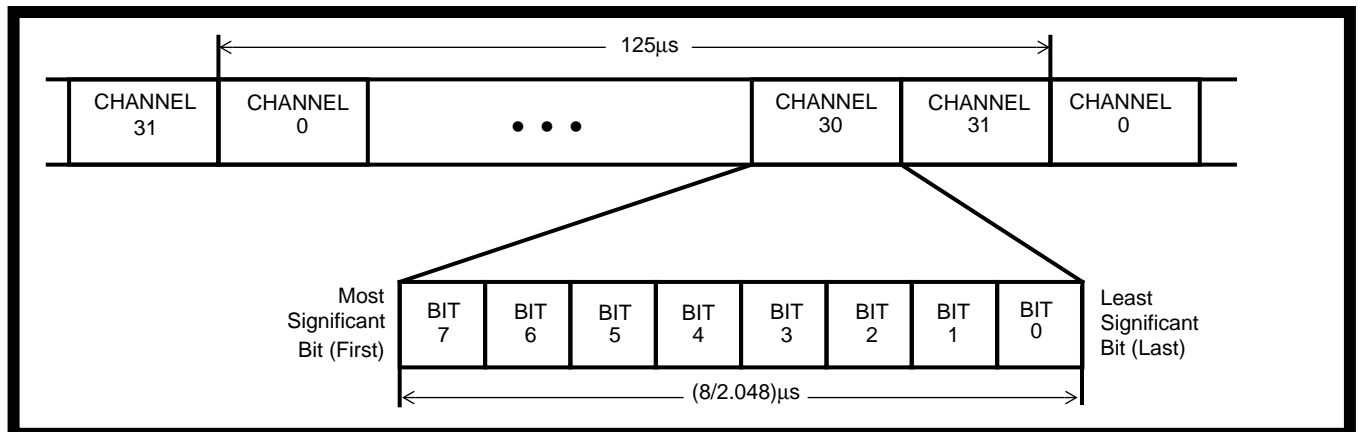

Figure 31 - ST-BUS Stream Format

Notes: