

*Designer's™ Data Sheet*  
**Fully Isolated TMOS E-FET™**  
**Power Field Effect Transistor**  
**N-Channel Enhancement-Mode Silicon Gate**  
**Isolated TO-220**

This high voltage MOSFET uses an advanced termination scheme to provide enhanced voltage-blocking capability without degrading performance over time. In addition, this advanced TMOS E-FET is designed to withstand high energy in the avalanche and commutation modes. The new energy efficient design also offers a drain-to-source diode with a fast recovery time. Designed for high voltage, high speed switching applications in power supplies, converters and PWM motor controls, these devices are particularly well suited for bridge circuits where diode speed and commutating safe operating areas are critical and offer additional safety margin against unexpected voltage transients.

- Robust High Voltage Termination
- Avalanche Energy Specified
- Source-to-Drain Diode Recovery Time Comparable to a Discrete Fast Recovery Diode
- Diode is Characterized for Use in Bridge Circuits
- $I_{DSS}$  and  $V_{DS(on)}$  Specified at Elevated Temperature
- Isolated Version of the MTP2N60E

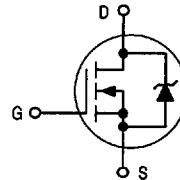

**MTA1N60E**

Motorola Preferred Device

**TMOS POWER FET**  
**1.0 AMPERE**  
**600 VOLTS**  
 **$R_{DS(on)} = 8.0 \text{ OHM}$**

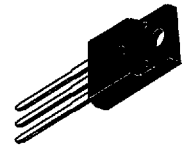

**CASE 221D-02, Style 1**  
**(ISOLATED TO-220 TYPE)**

**MAXIMUM RATINGS** ( $T_C = 25^\circ\text{C}$  unless otherwise noted)

Rating	Symbol	Value	Unit
Drain-Source Voltage	$V_{DSS}$	600	Vdc
Drain-Gate Voltage ( $R_{GS} = 1.0 \text{ M}\Omega$ )	$V_{DGR}$	600	Vdc
Gate-Source Voltage — Continuous	$V_{GS}$	$\pm 20$	Vdc
— Non-Repetitive ( $t_p \leq 10 \text{ ms}$ )	$V_{GSM}$	$\pm 40$	Vpk
Drain Current — Continuous	$I_D$	1.0	Adc
— Continuous @ $100^\circ\text{C}$	$I_D$	0.8	
— Single Pulse ( $t_p \leq 10 \mu\text{s}$ )	$I_{DM}$	3.0	Apk
Total Power Dissipation @ $T_C = 25^\circ\text{C}$	$P_D$	40	Watts
Derate above $25^\circ\text{C}$		0.32	$\text{W}/^\circ\text{C}$
Operating and Storage Temperature Range	$T_J, T_{stg}$	-55 to 150	$^\circ\text{C}$
Single Pulse Drain-to-Source Avalanche Energy — Starting $T_J = 25^\circ\text{C}$ ( $V_{DD} = 100 \text{ Vdc}$ , $V_{GS} = 10 \text{ Vdc}$ , $I_L = 3.0 \text{ Apk}$ , $L = 10 \text{ mH}$ , $R_G = 25 \Omega$ )	$E_{AS}$	45	mJ
Thermal Resistance — Junction to Case	$R_{\theta JC}$	3.13	$^\circ\text{C}/\text{W}$
— Junction to Ambient	$R_{\theta JA}$	71.4	
Maximum Lead Temperature for Soldering Purposes, 1/8" from case for 10 seconds	$T_L$	260	$^\circ\text{C}$

**Designer's Data for "Worst Case" Conditions** — The Designer's Data Sheet permits the design of most circuits entirely from the information presented. SOA Limit curves — representing boundaries on device characteristics — are given to facilitate "worst case" design.

Preferred devices are Motorola recommended choices for future use and best overall value.

**ELECTRICAL CHARACTERISTICS** (T<sub>J</sub> = 25°C unless otherwise noted)

Characteristic	Symbol	Min	Typ	Max	Unit
----------------	--------	-----	-----	-----	------

**OFF CHARACTERISTICS**

Drain-Source Breakdown Voltage (V <sub>GS</sub> = 0 Vdc, I <sub>D</sub> = 250 μAdc) Temperature Coefficient (Positive)	V <sub>(BR)DSS</sub>	600 —	— 720	— —	Vdc mV/°C
Zero Gate Voltage Drain Current (V <sub>DS</sub> = 600 Vdc, V <sub>GS</sub> = 0 Vdc) (V <sub>DS</sub> = 600 Vdc, V <sub>GS</sub> = 0 Vdc, T <sub>J</sub> = 125°C)	I <sub>DSS</sub>	— —	— —	10 100	μAdc
Gate-Body Leakage Current (V <sub>GS</sub> = ±20 Vdc, V <sub>DS</sub> = 0)	I <sub>GSS</sub>	—	—	100	nAdc

**ON CHARACTERISTICS (1)**

Gate Threshold Voltage (V <sub>DS</sub> = V <sub>GS</sub> , I <sub>D</sub> = 250 μAdc) Temperature Coefficient (Negative)	V <sub>GS(th)</sub>	2.0 —	3.2 6.0	4.0 —	Vdc mV/°C
Static Drain-Source On-Resistance (V <sub>GS</sub> = 10 Vdc, I <sub>D</sub> = 0.5 Adc)	R <sub>DS(on)</sub>	—	5.9	8.0	Ohm
Drain-Source On-Voltage (V <sub>GS</sub> = 10 Vdc) (I <sub>D</sub> = 1.0 Adc) (I <sub>D</sub> = 0.5 Adc, T <sub>J</sub> = 125°C)	V <sub>DS(on)</sub>	— —	— —	9.6 8.4	Vdc
Forward Transconductance (V <sub>DS</sub> = 15 Vdc, I <sub>D</sub> = 0.5 Adc)	g <sub>FS</sub>	0.5	0.8	—	mhos

**DYNAMIC CHARACTERISTICS**

Input Capacitance	(V <sub>DS</sub> = 25 Vdc, V <sub>GS</sub> = 0 Vdc, f = 1.0 MHz)	C <sub>iss</sub>	—	224	310	pF
Output Capacitance		C <sub>oss</sub>	—	27	40	
Reverse Transfer Capacitance		C <sub>rss</sub>	—	6.0	10	

**SWITCHING CHARACTERISTICS (2)**

Turn-On Delay Time	(V <sub>DD</sub> = 300 Vdc, I <sub>D</sub> = 1.0 Adc, V <sub>GS</sub> = 10 Vdc, R <sub>G</sub> = 9.1 Ω)	t <sub>d(on)</sub>	—	8.8	20	ns
Rise Time		t <sub>r</sub>	—	6.8	14	
Turn-Off Delay Time		t <sub>d(off)</sub>	—	15	30	
Fall Time		t <sub>f</sub>	—	20	40	
Gate Charge (See Figure 8)	(V <sub>DS</sub> = 400 Vdc, I <sub>D</sub> = 1.0 Adc, V <sub>GS</sub> = 10 Vdc)	Q <sub>T</sub>	—	7.1	11	nC
		Q <sub>1</sub>	—	1.7	—	
		Q <sub>2</sub>	—	3.2	—	
		Q <sub>3</sub>	—	3.9	—	

**SOURCE-DRAIN DIODE CHARACTERISTICS**

Forward On-Voltage (1)	(I <sub>S</sub> = 1.0 Adc, V <sub>GS</sub> = 0 Vdc) (I <sub>S</sub> = 1.0 Adc, V <sub>GS</sub> = 0 Vdc, T <sub>J</sub> = 125°C)	V <sub>SD</sub>	— —	0.82 0.7	1.4 —	Vdc
Reverse Recovery Time (See Figure 14)	(I <sub>S</sub> = 1.0 Adc, V <sub>GS</sub> = 0 Vdc, di <sub>S</sub> /dt = 100 A/μs)	t <sub>rr</sub>	—	464	—	ns
		t <sub>a</sub>	—	36	—	
		t <sub>b</sub>	—	428	—	
Reverse Recovery Stored Charge		Q <sub>RR</sub>	—	0.629	—	μC

**INTERNAL PACKAGE INDUCTANCE**

Internal Drain Inductance (Measured from contact screw on tab to center of die) (Measured from the drain lead 0.25" from package to center of die)	L <sub>D</sub>	— —	3.5 4.5	— —	nH
Internal Source Inductance (Measured from the source lead 0.25" from package to source bond pad)	L <sub>S</sub>	—	7.5	—	nH

- (1) Pulse Test: Pulse Width ≤ 300 μs, Duty Cycle ≤ 2%.
- (2) Switching characteristics are independent of operating junction temperature.

9

TYPICAL ELECTRICAL CHARACTERISTICS

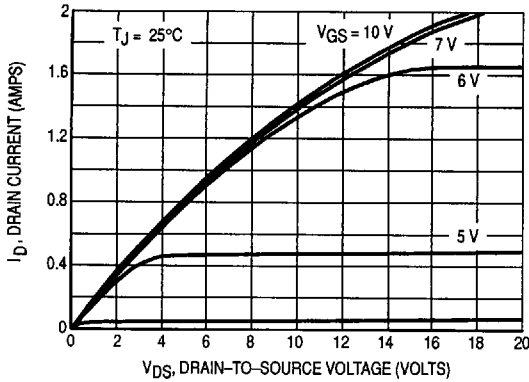

Figure 1. On-Region Characteristics

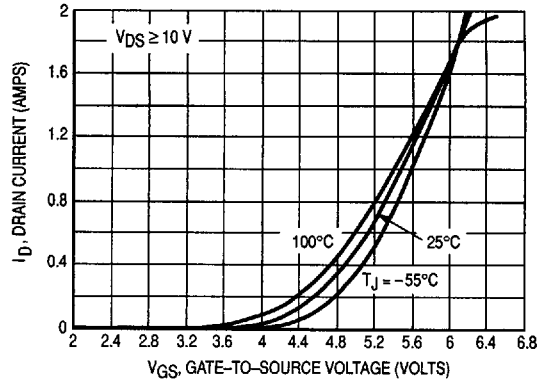

Figure 2. Transfer Characteristics

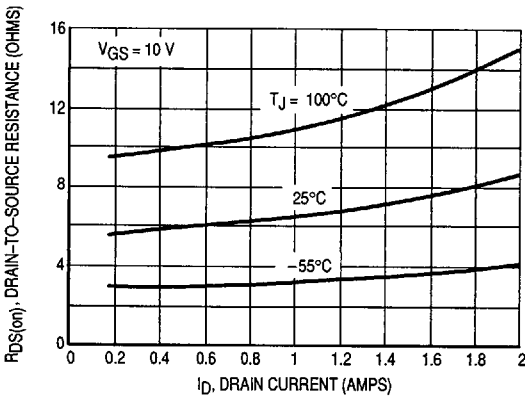

Figure 3. On-Resistance versus Drain Current and Temperature

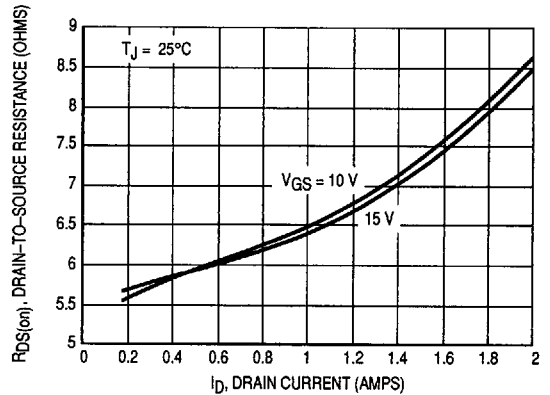

Figure 4. On-Resistance versus Drain Current and Gate Voltage

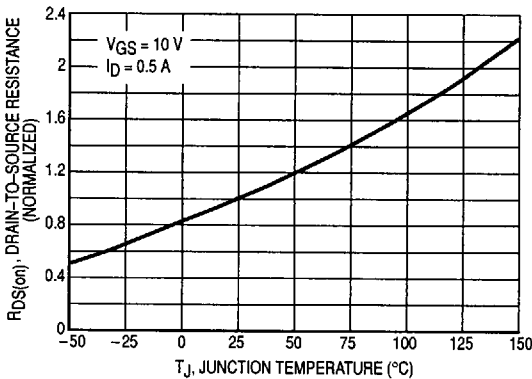

Figure 5. On-Resistance Variation with Temperature

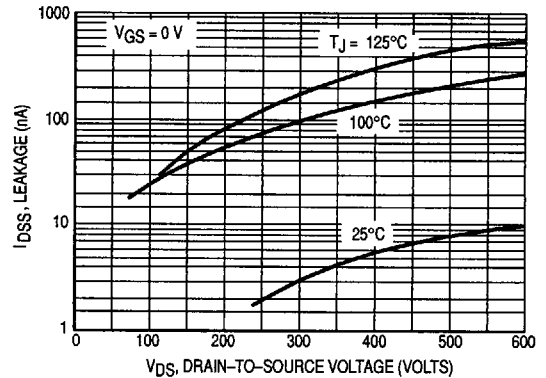

Figure 6. Drain-to-Source Leakage Current versus Voltage

POWER MOSFET SWITCHING

Switching behavior is most easily modeled and predicted by recognizing that the power MOSFET is charge controlled. The lengths of various switching intervals ( $\Delta t$ ) are determined by how fast the FET input capacitance can be charged by current from the generator.

The published capacitance data is difficult to use for calculating rise and fall because drain-gate capacitance varies greatly with applied voltage. Accordingly, gate charge data is used. In most cases, a satisfactory estimate of average input current ( $I_G(AV)$ ) can be made from a rudimentary analysis of the drive circuit so that

$$t = Q/I_G(AV)$$

During the rise and fall time interval when switching a resistive load,  $V_{GS}$  remains virtually constant at a level known as the plateau voltage,  $V_{GSP}$ . Therefore, rise and fall times may be approximated by the following:

$$t_r = Q_2 \times R_G / (V_{GG} - V_{GSP})$$

$$t_f = Q_2 \times R_G / V_{GSP}$$

where

$V_{GG}$  = the gate drive voltage, which varies from zero to  $V_{GG}$

$R_G$  = the gate drive resistance

and  $Q_2$  and  $V_{GSP}$  are read from the gate charge curve.

During the turn-on and turn-off delay times, gate current is not constant. The simplest calculation uses appropriate values from the capacitance curves in a standard equation for voltage change in an RC network. The equations are:

$$t_{d(on)} = R_G C_{iss} \ln [V_{GG}/(V_{GG} - V_{GSP})]$$

$$t_{d(off)} = R_G C_{iss} \ln (V_{GG}/V_{GSP})$$

The capacitance ( $C_{iss}$ ) is read from the capacitance curve at a voltage corresponding to the off-state condition when calculating  $t_{d(on)}$  and is read at a voltage corresponding to the on-state when calculating  $t_{d(off)}$ .

At high switching speeds, parasitic circuit elements complicate the analysis. The inductance of the MOSFET source lead, inside the package and in the circuit wiring which is common to both the drain and gate current paths, produces a voltage at the source which reduces the gate drive current. The voltage is determined by  $L di/dt$ , but since  $di/dt$  is a function of drain current, the mathematical solution is complex. The MOSFET output capacitance also complicates the mathematics. And finally, MOSFETs have finite internal gate resistance which effectively adds to the resistance of the driving source, but the internal resistance is difficult to measure and, consequently, is not specified.

The resistive switching time variation versus gate resistance (Figure 9) shows how typical switching performance is affected by the parasitic circuit elements. If the parasitics were not present, the slope of the curves would maintain a value of unity regardless of the switching speed. The circuit used to obtain the data is constructed to minimize common inductance in the drain and gate circuit loops and is believed readily achievable with board mounted components. Most power electronic loads are inductive; the data in the figure is taken with a resistive load, which approximates an optimally snubbed inductive load. Power MOSFETs may be safely operated into an inductive load; however, snubbing reduces switching losses.

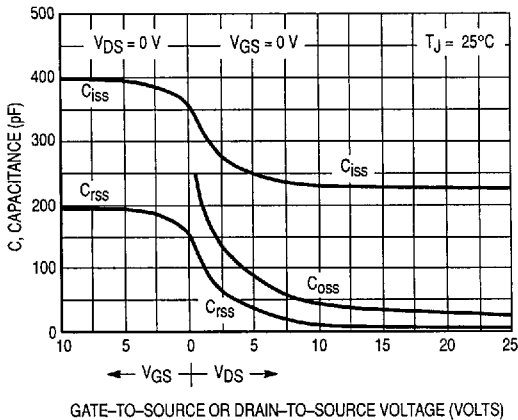

Figure 7a. Capacitance Variation

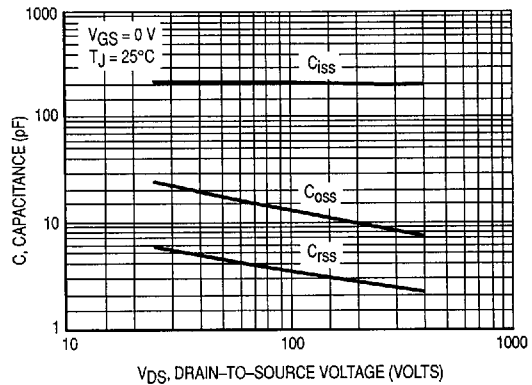

Figure 7b. High Voltage Capacitance Variation

## MTA1N60E

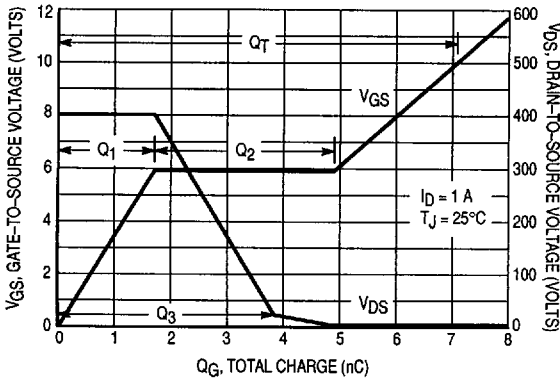

Figure 8. Gate-To-Source and Drain-To-Source Voltage versus Total Charge

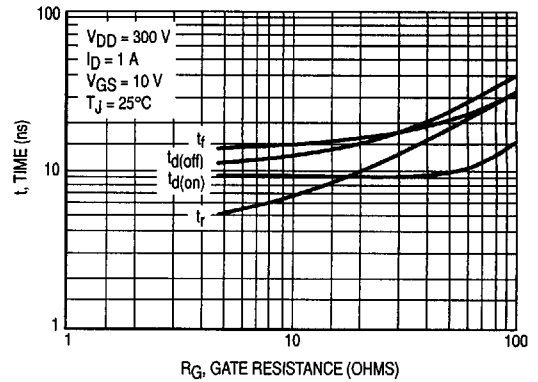

Figure 9. Resistive Switching Time Variation versus Gate Resistance

## DRAIN-TO-SOURCE DIODE CHARACTERISTICS

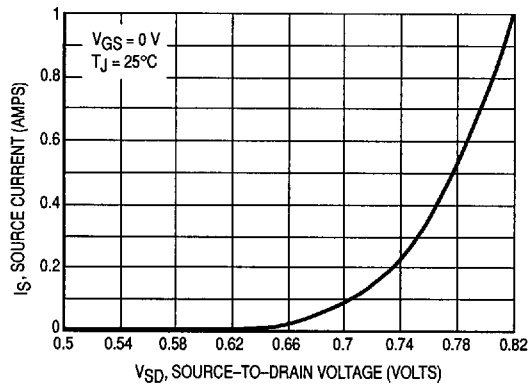

Figure 10. Diode Forward Voltage versus Current

## SAFE OPERATING AREA

The Forward Biased Safe Operating Area curves define the maximum simultaneous drain-to-source voltage and drain current that a transistor can handle safely when it is forward biased. Curves are based upon maximum peak junction temperature and a case temperature ( $T_C$ ) of 25°C. Peak repetitive pulsed power limits are determined by using the thermal response data in conjunction with the procedures discussed in AN569, "Transient Thermal Resistance—General Data and Its Use."

Switching between the off-state and the on-state may traverse any load line provided neither rated peak current ( $I_{DM}$ ) nor rated voltage ( $V_{DSS}$ ) is exceeded and the transition time ( $t_r, t_f$ ) do not exceed 10  $\mu$ s. In addition the total power averaged over a complete switching cycle must not exceed  $(T_{J(MAX)} - T_C)/(R_{\theta JC})$ .

A Power MOSFET designated E-FET can be safely used in switching circuits with unclamped inductive loads. For reli-

able operation, the stored energy from circuit inductance dissipated in the transistor while in avalanche must be less than the rated limit and adjusted for operating conditions differing from those specified. Although industry practice is to rate in terms of energy, avalanche energy capability is not a constant. The energy rating decreases non-linearly with an increase of peak current in avalanche and peak junction temperature.

Although many E-FETs can withstand the stress of drain-to-source avalanche at currents up to rated pulsed current ( $I_{DM}$ ), the energy rating is specified at rated continuous current ( $I_D$ ), in accordance with industry custom. The energy rating must be derated for temperature as shown in the accompanying graph (Figure 12). Maximum energy at currents below rated continuous  $I_D$  can safely be assumed to equal the values indicated.

SAFE OPERATING AREA

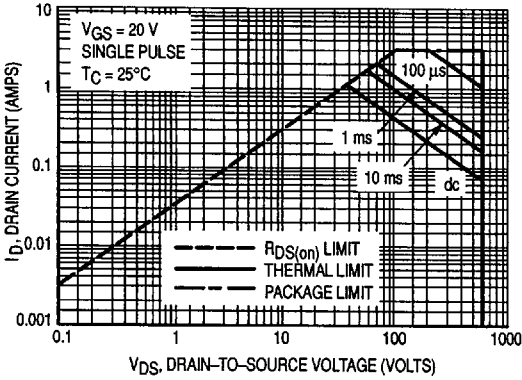

Figure 11. Maximum Rated Forward Biased Safe Operating Area

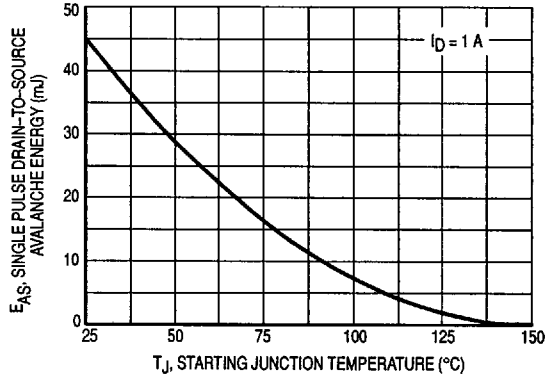

Figure 12. Maximum Avalanche Energy versus Starting Junction Temperature

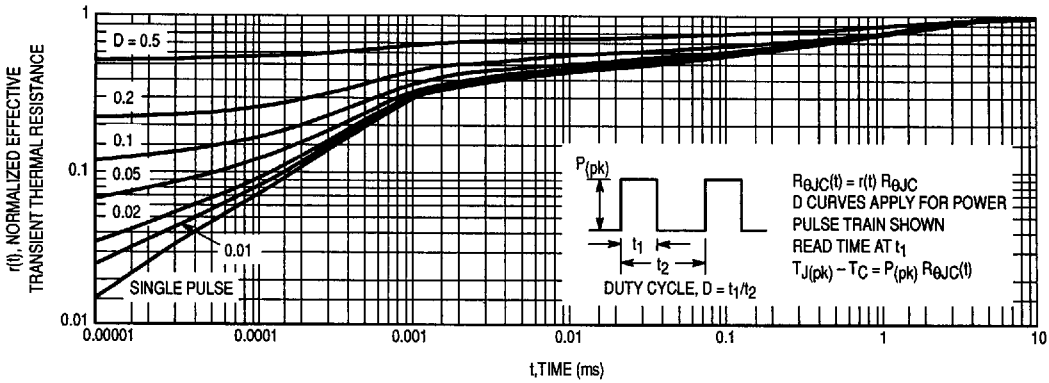

Figure 13. Thermal Response

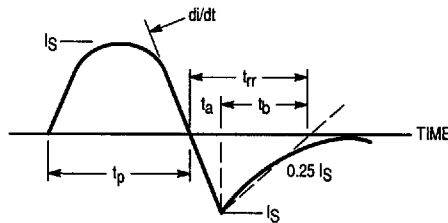

Figure 14. Diode Reverse Recovery Waveform

*Designer's™ Data Sheet*  
**Fully Isolated TMOS E-FET™**  
**High Energy Power FET**  
**N-Channel Enhancement-Mode Silicon Gate**

**MTA2N60E**

Motorola Preferred Device

**TMOS POWER FET**  
**2.0 AMPERES**  
**600 VOLTS**  
**R<sub>DS(on)</sub> = 2.2 OHMS MAX**

This advanced high voltage TMOS E-FET is designed to withstand high energy in the avalanche mode and commutation modes. This new high energy device also offers a drain-to-source diode with fast recovery time. Designed for high voltage, high speed switching applications such as power supplies, PWM motor controls and other inductive loads, the avalanche energy capability is specified to eliminate the guesswork in designs where inductive loads are switched and offer additional safety margin against unexpected voltage transients.

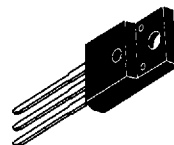

- Designed to Eliminate the Need for External Zener Transient Suppressor — Absorbs High Energy in the Avalanche Mode
- Commutating Safe Operating Area (CSOA) Specified for Use in Half and Full Bridge Circuits
- Diode is Characterized for Use in Bridge Circuits
- I<sub>DSS</sub> and V<sub>DS(on)</sub> Specified at Elevated Temperature
- Isolated Version of the MTP3N60E

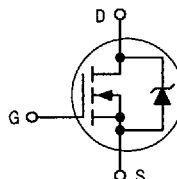

**CASE 221D-02, Style 1**  
**(ISOLATED TO-220 TYPE)**

9

**MAXIMUM RATINGS** (T<sub>C</sub> = 25°C unless otherwise noted)

Rating	Symbol	Value	Unit
Drain-to-Source Voltage	V <sub>DSS</sub>	600	Volts
Drain-to-Gate Voltage (R <sub>GS</sub> = 1.0 MΩ)	V <sub>DGR</sub>	600	Volts
Gate-to-Source Voltage — Continuous — Non-Repetitive (t <sub>p</sub> ≤ 50 μs)	V <sub>GS</sub> V <sub>GSM</sub>	±20 ±40	Volts
Drain Current — Continuous — Single Pulse (t <sub>p</sub> ≤ 10 μs)	I <sub>D</sub> I <sub>DM</sub>	2.0 9.0	Amps
RMS Isolation Voltage (t = 1 second, R.H. ≤ 30%, T <sub>A</sub> = 25°C)	V <sub>ISO1</sub> V <sub>ISO2</sub> V <sub>ISO3</sub>	4500 3500 1500	Volts
Total Power Dissipation @ T <sub>C</sub> = 25°C Derate above 25°C	P <sub>D</sub>	50 0.4	Watts W/°C
Operating and Storage Temperature Range	T <sub>J</sub> , T <sub>stg</sub>	-55 to 150	°C

**UNCLAMPED DRAIN-TO-SOURCE AVALANCHE CHARACTERISTICS** (T<sub>J</sub> ≤ 150°C)

Single Pulse Drain-to-Source Avalanche Energy — Starting T <sub>J</sub> = 25°C (V <sub>DD</sub> = 75 V, V <sub>GS</sub> = 10 V, L = 64 mH, R <sub>G</sub> = 25 Ω, Peak I <sub>L</sub> = 4.0 A) (See Figures 16, 17 and 18)	E <sub>AS</sub>	290	mJ
--	-----------------	-----	----

**THERMAL CHARACTERISTICS**

Thermal Resistance — Junction to Case — Junction to Ambient	R <sub>θJC</sub> R <sub>θJA</sub>	2.7 62.5	°C/W
Maximum Lead Temperature for Soldering Purposes, 1/8" from case for 10 seconds	T <sub>L</sub>	260	°C

**Designer's Data for "Worst Case" Conditions** — The Designer's Data Sheet permits the design of most circuits entirely from the information presented. SOA Limit curves — representing boundaries on device characteristics — are given to facilitate "worst case" design.

Preferred devices are Motorola recommended choices for future use and best overall value.

REV 1

**ELECTRICAL CHARACTERISTICS** ( $T_J = 25^\circ\text{C}$  unless otherwise noted)

Characteristic	Symbol	Min	Typ	Max	Unit
----------------	--------	-----	-----	-----	------

**OFF CHARACTERISTICS**

Drain-to-Source Breakdown Voltage ( $V_{GS} = 0$ , $I_D = 250 \mu\text{A}$ ) Temperature Coefficient (positive)	$V_{(BR)DSS}$	600 —	— 480	— —	Vdc mV/°C
Zero Gate Voltage Drain Current ( $V_{DS} = 600 \text{ V}$ , $V_{GS} = 0$ ) ( $V_{DS} = 480 \text{ V}$ , $V_{GS} = 0$ , $T_J = 125^\circ\text{C}$ )	$I_{DSS}$	— —	— —	0.25 1.0	mA
Gate-Body Leakage Current — Forward ( $V_{GSF} = 20 \text{ Vdc}$ , $V_{DS} = 0$ )	$I_{GSSF}$	—	—	100	nA
Gate-Body Leakage Current — Reverse ( $V_{GSR} = 20 \text{ Vdc}$ , $V_{DS} = 0$ )	$I_{GSSR}$	—	—	100	nA

**ON CHARACTERISTICS\***

Gate Threshold Voltage ( $V_{DS} = V_{GS}$ , $I_D = 250 \mu\text{A}$ ) Temperature Coefficient (negative)	$V_{GS(th)}$	2.0 —	2.8 8.5	4.0 —	Vdc mV/°C
Static Drain-to-Source On-Resistance ( $V_{GS} = 10 \text{ Vdc}$ , $I_D = 1.5 \text{ A}$ )	$R_{DS(on)}$	—	1.9	2.2	Ohm
Drain-to-Source On-Voltage ( $V_{GS} = 10 \text{ V}$ ) ( $I_D = 3.0 \text{ A}$ ) ( $I_D = 1.5 \text{ A}$ , $T_J = 125^\circ\text{C}$ )	$V_{DS(on)}$	— —	— —	7.0 7.5	Vdc
Forward Transconductance ( $V_{DS} \geq 15 \text{ V}$ , $I_D = 1.5 \text{ A}$ )	$g_{FS}$	1.5	—	—	mhos

**DYNAMIC CHARACTERISTICS**

Input Capacitance	$(V_{DS} = 25 \text{ V}$ , $V_{GS} = 0$ , $f = 1.0 \text{ MHz}$ ) See Figures 14 and 15	$C_{iss}$	—	800	—	pF
Reverse Transfer Capacitance		$C_{rss}$	—	19	—	
Output Capacitance		$C_{oss}$	—	105	—	

**SWITCHING CHARACTERISTICS** ( $T_J = 100^\circ\text{C}$ )

Turn-On Delay Time	$(V_{DS} = 300 \text{ V}$ , $I_D = 3.0 \text{ A}$ , $V_{GS} = 10 \text{ V}$ , $R_g = 12 \Omega$ ) See Figure 7	$t_{d(on)}$	—	16	—	ns
Rise Time		$t_r$	—	27	—	
Turn-Off Delay Time		$t_{d(off)}$	—	32	—	
Fall Time		$t_f$	—	25	—	
Gate Charge	$(V_{DS} = 400 \text{ V}$ , $I_D = 3.0 \text{ A}$ , $V_{GS} = 10 \text{ Vdc}$ ) See Figures 5 and 6	$Q_T$	—	24	31	nC
		$Q_1$	—	4.0	—	
		$Q_2$	—	10	—	
		$Q_3$	—	8.0	—	

**SOURCE-DRAIN DIODE CHARACTERISTICS\***

Forward On-Voltage	$(I_S = 3.0 \text{ A}$ , $V_{GS} = 0$ ) ( $I_S = 3.0 \text{ A}$ , $V_{GS} = 0$ , $T_J = 125^\circ\text{C}$ )	$V_{SD}$	—	1.0	1.4	Vdc
			—	0.9	—	
Reverse Recovery Time	$(I_S = 3.0 \text{ A}$ , $V_{GS} = 0$ , $di_S/dt = 100 \text{ A}/\mu\text{s}$ )	$t_{rr}$	—	350	—	ns

**INTERNAL PACKAGE INDUCTANCE**

Internal Drain Inductance (Measured from the drain lead 0.25" from package to center of die)	$L_D$	—	4.5	—	nH
Internal Source Inductance (Measured from the source lead 0.25" from package to source bond pad)	$L_S$	—	7.5	—	

**ISOLATION CAPACITANCE**

Isolation Capacitance, Drain-to-Heatsink	$C_{iso}$	—	15	—	pF
--	-----------	---	----	---	----

\* Pulse Test: Pulse Width  $\leq 300 \mu\text{s}$ , Duty Cycle  $\leq 2.0\%$ .



TYPICAL ELECTRICAL CHARACTERISTICS

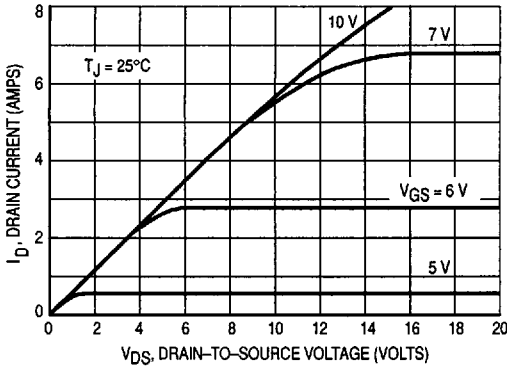

Figure 1. On-Region Characteristics

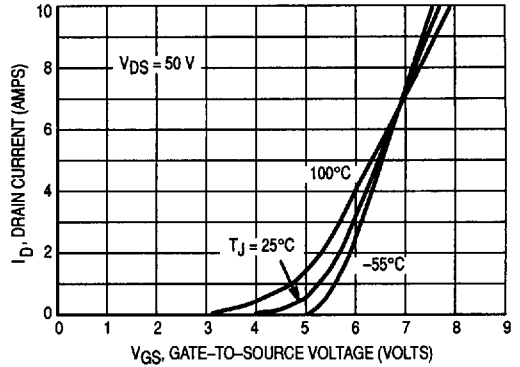

Figure 2. Transfer Characteristics

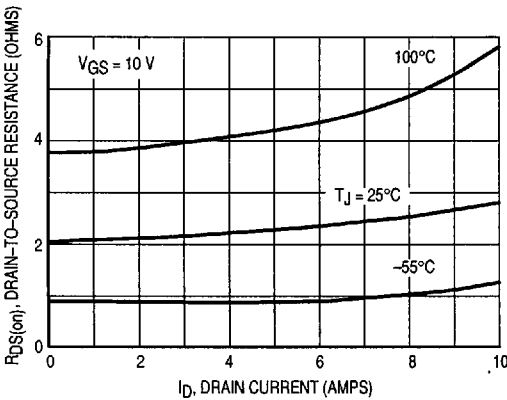

Figure 3. On-Resistance versus Drain Current

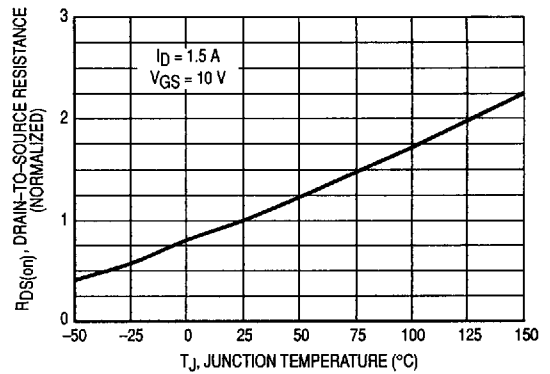

Figure 4. On-Resistance Variation With Temperature

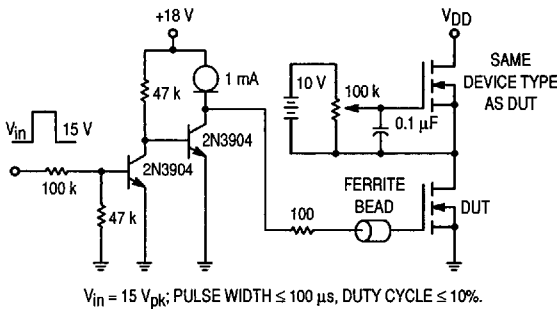

Figure 5. Gate Charge Test Circuit

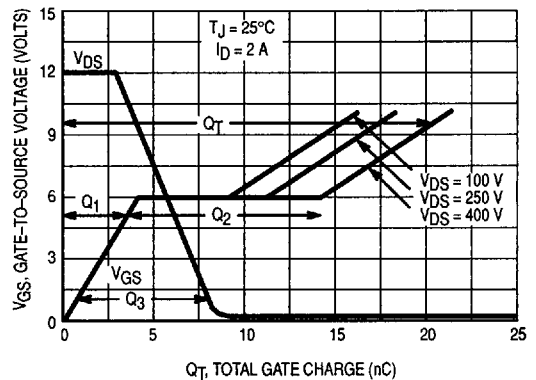

Figure 6. Gate Charge versus Gate-to-Source Voltage

SAFE OPERATING AREA INFORMATION

FORWARD BIASED SAFE OPERATING AREA

The FBSOA curves define the maximum drain-to-source voltage and drain current that a device can safely handle when it is forward biased, or when it is on, or being turned on. Because these curves include the limitations of simultaneous high voltage and high current, up to the rating of the device, they are especially useful to designers of linear systems. The curves are based on a case temperature of 25°C and a maximum junction temperature of 150°C. Limitations for repetitive pulses at various case temperatures can be determined by using the thermal response curves. Motorola Application Note, AN569, "Transient Thermal Resistance—General Data and Its Use" provides detailed instructions.

SWITCHING SAFE OPERATING AREA

The switching safe operating area (SOA) of Figure 9 is the boundary that the load line may traverse without incurring damage to the MOSFET. The fundamental limits are the peak current,  $I_{DM}$  and the breakdown voltage,  $BV_{DSS}$ . The switching SOA shown in Figure 9 is applicable for both turn-on and turn-off of the devices for switching times less than one microsecond.

The power averaged over a complete switching cycle must be less than:

$$\frac{T_{J(max)} - T_C}{R_{\theta JC}}$$

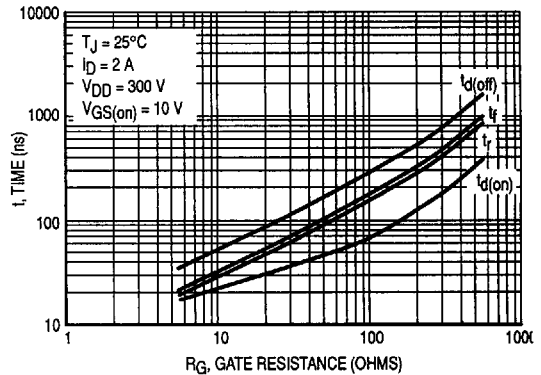

Figure 7. Resistive Switching Time Variation versus Gate Resistance

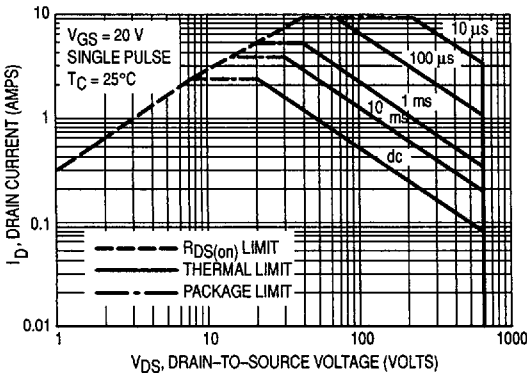

Figure 8. Maximum Rated Forward Biased Safe Operating Area

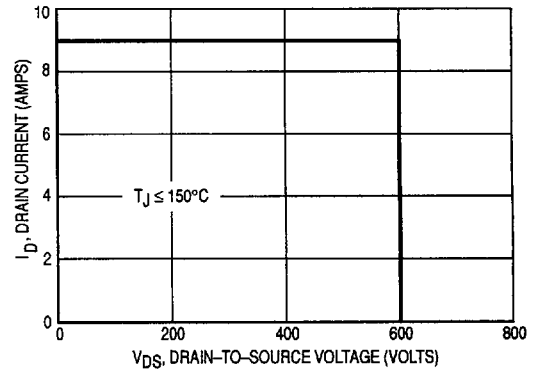

Figure 9. Maximum Rated Switching Safe Operating Area

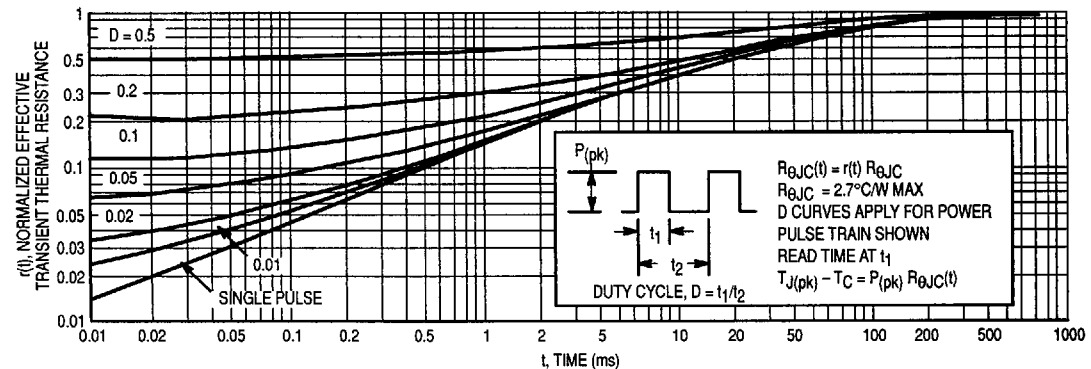

Figure 10. Thermal Response

COMMUTATING SAFE OPERATING AREA (CSOA)

The Commutating Safe Operating Area (CSOA) of Figure 12 defines the limits of safe operation for commutated source-drain current versus re-applied drain voltage when the source-drain diode has undergone forward bias. The curve shows the limitations of  $I_{FM}$  and peak  $V_{DS}$  for a given rate of change of source current. It is applicable when waveforms similar to those of Figure 11 are present. Full or half-bridge PWM DC motor controllers are common applications requiring CSOA data.

Device stresses increase with increasing rate of change of source current so  $di_s/dt$  is specified with a maximum value. Higher values of  $di_s/dt$  require an appropriate derating of  $I_{FM}$ , peak  $V_{DS}$  or both. Ultimately  $di_s/dt$  is limited primarily by device, package, and circuit impedances. Maximum device stress occurs during  $t_{rr}$  as the diode goes from conduction to reverse blocking.

$V_{DS(pk)}$  is the peak drain-to-source voltage that the device must sustain during commutation;  $I_{FM}$  is the maximum forward source-drain diode current just prior to the onset of commutation.

$V_R$  is specified at 80% of  $V_{(BR)DSS}$  to ensure that the CSOA stress is maximized as  $I_S$  decays from  $I_{FM}$  to zero.

$R_{GS}$  should be minimized during commutation.  $T_J$  has only a second order effect on CSOA.

Stray inductances in Motorola's test circuit are assumed to be practical minimums.  $dV_{DS}/dt$  in excess of 10 V/ns was attained with  $di_s/dt$  of 400 A/ $\mu$ s.

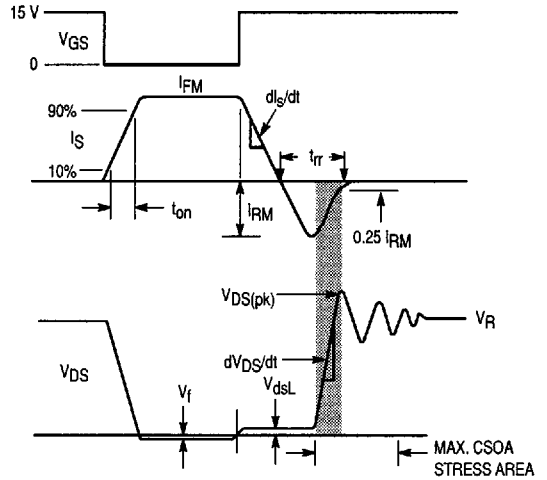

Figure 11. Commutating Waveforms

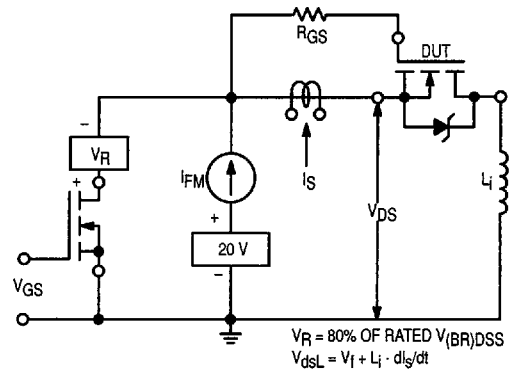

Figure 13. Commutating Safe Operating Area Test Circuit

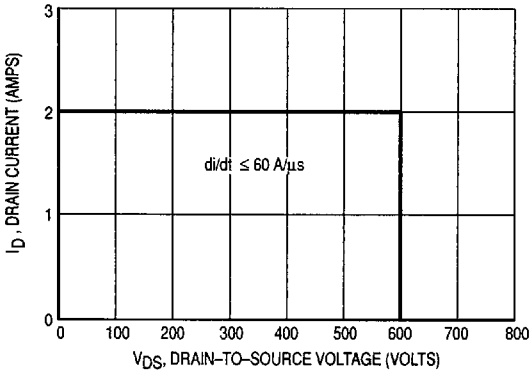

Figure 12. Commutating Safe Operating Area (CSOA)

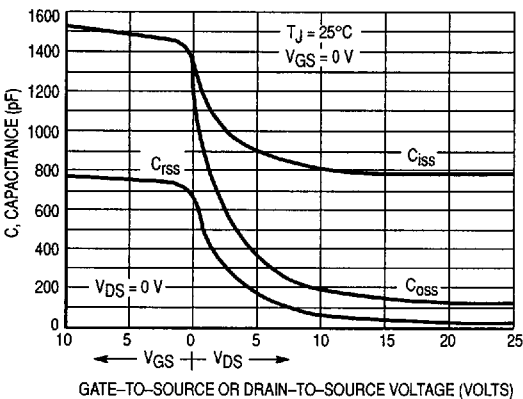

Figure 14. Low Voltage Capacitance Variation

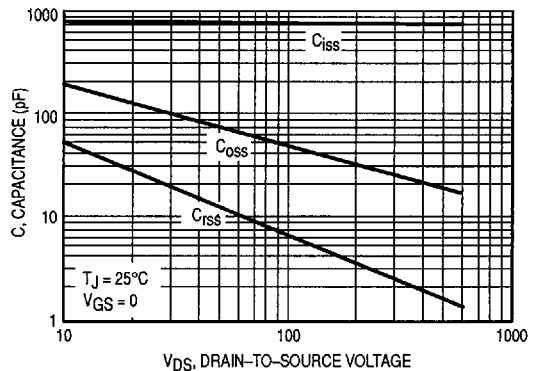

Figure 15. High Voltage Capacitance Variation

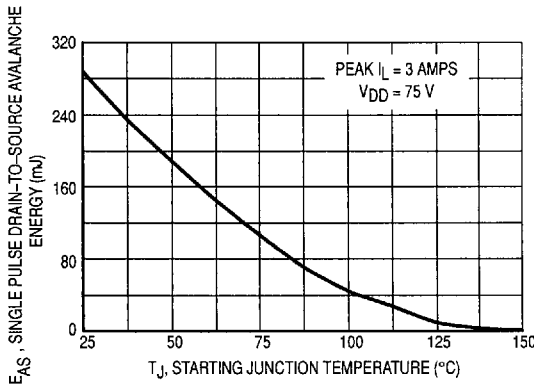

Figure 16. Maximum Avalanche Energy versus Starting Junction Temperature

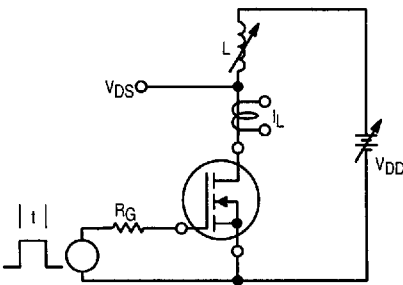

Figure 17. Unclamped Inductive Switching Test Circuit

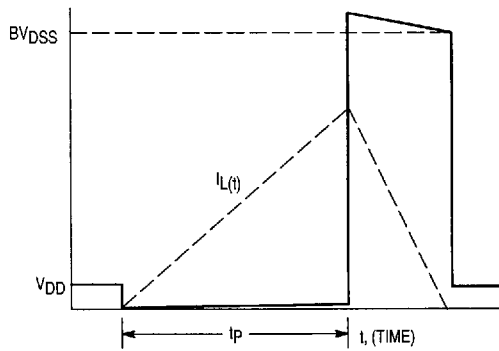

Figure 18. Unclamped Inductive Switching Waveforms

TEST CONDITIONS FOR ISOLATION TESTS\*

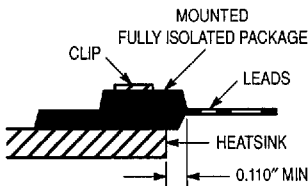

Figure 19. Clip Mounting Position for Isolation Test Number 1

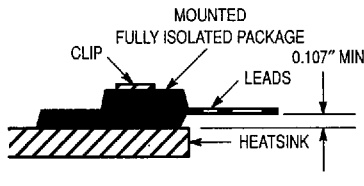

Figure 20. Clip Mounting Position for Isolation Test Number 2

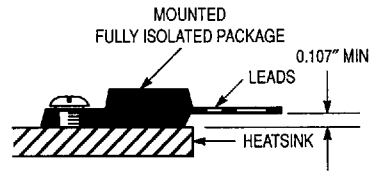
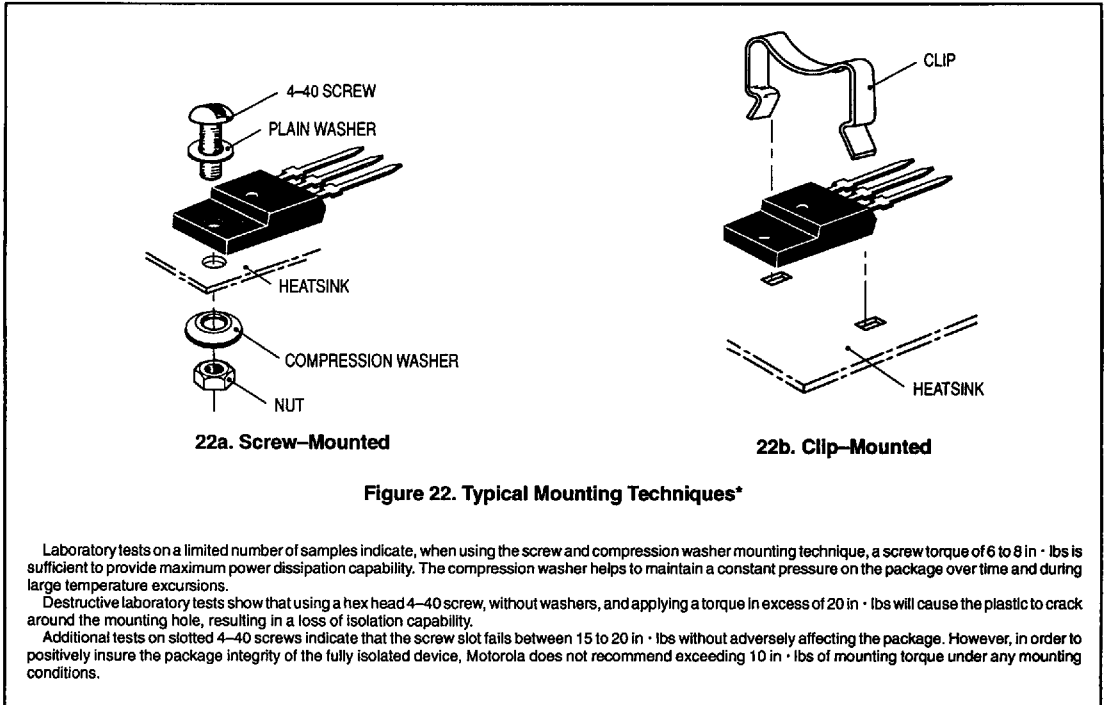

Figure 21. Screw Mounting Position for Isolation Test Number 3

\* Measurement made between leads and heatsink with all leads shorted together.

## MOUNTING INFORMATION\*\*



\*\* For more information about mounting power semiconductors see Application Note AN1040.