

**N- AND P-Channel Enhancement Mode MOSFET**

# MTC4203N8J

	N-CH	P-CH
BV <sub>DSS</sub>	30V	-30V
I <sub>D</sub> @V <sub>GS</sub> =10V(-10V), T <sub>A</sub> =25°C	4.4A	-4.5A
I <sub>D</sub> @V <sub>GS</sub> =10V(-10V), T <sub>C</sub> =25°C	6.3A	-6.5A
R <sub>DS(on)</sub> @V <sub>GS</sub> =10V(-10V) typ.	28mΩ	31mΩ
R <sub>DS(on)</sub> @V <sub>GS</sub> =4.5V(-4.5V) typ.	52mΩ	43mΩ
R <sub>DS(on)</sub> @V <sub>GS</sub> =4V(-4V) typ.	66mΩ	47mΩ

**Features**

- Simple drive requirement
- Low on-resistance
- Fast switching speed
- Pb-free lead plating and halogen-free package

**Equivalent Circuit**

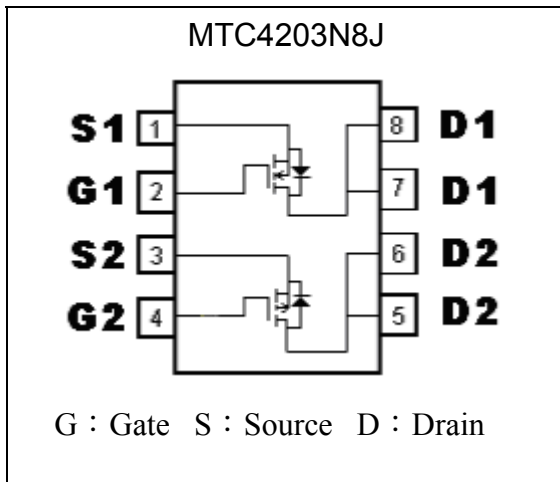

**Outline**

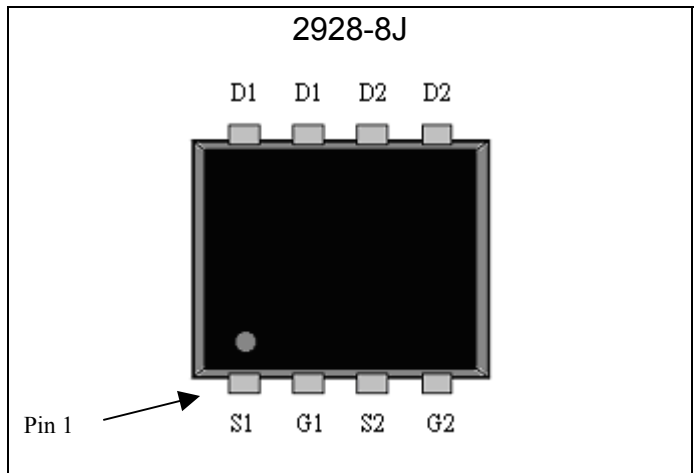

**Ordering Information**

Device	Package	Shipping
MTC4203N8J-0-T1-G	2928-8J (Pb-free lead plating and halogen-free package)	3000 pcs / Tape & Reel

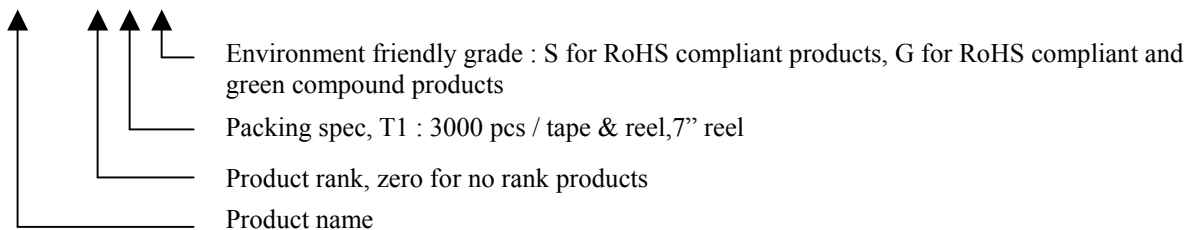



**Absolute Maximum Ratings** ( $T_C=25^{\circ}C$ , unless otherwise noted)

Parameter		Symbol	Limits		Unit
			N-channel	P-channel	
Drain-Source Breakdown Voltage		$BV_{DSS}$	30	-30	V
Gate-Source Voltage		$V_{GS}$	$\pm 20$	$\pm 20$	
Continuous Drain Current *2	$T_A=25^{\circ}C, V_{GS}=10V (-10V)$	$I_{DSM}$	4.4	-4.5	A
	$T_A=70^{\circ}C, V_{GS}=10V (-10V)$		3.5	-3.6	
Continuous Drain Current	$T_C=25^{\circ}C, V_{GS}=10V (-10V)$	$I_D$	6.3	-6.5	
	$T_C=100^{\circ}C, V_{GS}=10V (-10V)$		4.0	-4.1	
Pulsed Drain Current *3		$I_{DM}$	20	-20	
Total Power Dissipation	$T_A=25^{\circ}C$ , Single device operation	$P_{DSM}$	1.5 *2		
	$T_A=70^{\circ}C$ , Single device operation		0.96 *2		
	$T_A=25^{\circ}C$ , Single device value at dual operation		1.24 *2		
	$T_A=70^{\circ}C$ , Single device value at dual operation		0.79 *2		
	$T_C=25^{\circ}C$	$P_D * 1$	3.75		
	$T_C=100^{\circ}C$		1.88		
Operating Junction and Storage Temperature Range		$T_j; T_{stg}$	-55~+175		$^{\circ}C$

**Thermal Data**

Parameter	Symbol	Value	Unit
Max. Thermal Resistance, Junction-to-ambient, single device operation	$R_{th,j-a}$	84 *2	$^{\circ}C/W$
Max. Thermal Resistance, Junction-to-ambient, single device value at dual operation		101 *2	
Max. Thermal Resistance, Junction-to-case	$R_{th,j-c}$	40	

- Note : 1. The power dissipation  $P_D$  is based on  $T_{J(MAX)}=175^{\circ}C$ , using junction-to-case thermal resistance, and is more useful in setting the upper dissipation limit for cases where additional heatsinking is used.
2. The value of  $R_{\theta JA}$  is measured with the device mounted on 1 in<sup>2</sup>FR-4 board with 2 oz. copper, in a still air environment with  $T_A=25^{\circ}C, t \leq 5s$ .  $216^{\circ}C/W$  when mounted on a minimum pad of 2 oz. copper. The power dissipation  $P_{DSM}$  is based on  $R_{\theta JA}$  and the maximum allowed junction temperature of  $150^{\circ}C$ . The value in any given application depends on the user's specific board design.
3. Pulse width limited by junction temperature  $T_{J(MAX)}=175^{\circ}C$ . Ratings are based on low duty cycles to keep initial  $T_J=25^{\circ}C$ .

**N-Channel Electrical Characteristics** ( $T_C=25^{\circ}C$ , unless otherwise specified)

Symbol	Min.	Typ.	Max.	Unit	Test Conditions
<b>Static</b>					
$BV_{DSS}$	30	-	-	V	$V_{GS}=0V, I_D=250\mu A$
$V_{GS(th)}$	1	-	2.5		$V_{DS}=V_{GS}, I_D=250\mu A$
$I_{GSS}$	-	-	$\pm 100$	nA	$V_{GS}=\pm 20V, V_{DS}=0V$
$I_{DSS}$	-	-	1	$\mu A$	$V_{DS}=30V, V_{GS}=0V$
	-	-	10		$V_{DS}=24V, V_{GS}=0V, T_j=70^{\circ}C$
* $R_{DS(ON)}$	-	28	36	m $\Omega$	$V_{GS}=10V, I_D=2A$
	-	52	73		$V_{GS}=4.5V, I_D=1A$
	-	66	92		$V_{GS}=4V, I_D=1A$
* $G_{FS}$	-	3.1	-	S	$V_{DS}=10V, I_D=3A$



<b>Dynamic</b>					
Ciss	-	342	-	pF	V <sub>DS</sub> =10V, V <sub>GS</sub> =0V, f=1MHz
Coss	-	44	-		
Crss	-	41	-		
*td(ON)	-	5	-	ns	V <sub>DS</sub> =15V, I <sub>D</sub> =2A, V <sub>GS</sub> =10V, R <sub>G</sub> =1 Ω
*tr	-	16.6	-		
*td(OFF)	-	14.6	-		
*tf	-	4.6	-		
*Qg	-	7.1	-	nC	V <sub>DS</sub> =24V, I <sub>D</sub> =2A, V <sub>GS</sub> =10V
*Qgs	-	1.6	-		
*Qgd	-	1.2	-		
<b>Body Diode</b>					
*V <sub>SD</sub>	-	0.89	1.2	V	V <sub>GS</sub> =0V, I <sub>S</sub> =4.5A
*trr	-	6.2	-	ns	I <sub>F</sub> =4.5A, V <sub>GS</sub> =0V, dI <sub>F</sub> /dt=100A/μs
*Qrr	-	2.8	-	nC	

\*Pulse Test : Pulse Width ≤300μs, Duty Cycle≤2%

**P-Channel Electrical Characteristics (T<sub>c</sub>=25°C, unless otherwise specified)**

Symbol	Min.	Typ.	Max.	Unit	Test Conditions
<b>Static</b>					
B <sub>V</sub> DSS	-30	-	-	V	V <sub>GS</sub> =0, I <sub>D</sub> =-250μA
V <sub>GS(th)</sub>	-1.0	-	-2.5		V <sub>DS</sub> =V <sub>GS</sub> , I <sub>D</sub> =-250μA
I <sub>GSS</sub>	-	-	±100	nA	V <sub>GS</sub> =±20V, V <sub>DS</sub> =0V
I <sub>DSS</sub>	-	-	-1	μA	V <sub>DS</sub> =-30V, V <sub>GS</sub> =0V
	-	-	-10		V <sub>DS</sub> =-24V, V <sub>GS</sub> =0V, T <sub>j</sub> =70°C
*R <sub>D</sub> S(ON)	-	31	40	mΩ	V <sub>GS</sub> =-10V, I <sub>D</sub> =-2A
	-	43	60		V <sub>GS</sub> =-4.5V, I <sub>D</sub> =-1A
	-	47	66		V <sub>GS</sub> =-4V, I <sub>D</sub> =-1A
*G <sub>FS</sub>	-	4.9	-	S	V <sub>DS</sub> =-10V, I <sub>D</sub> =-3A
<b>Dynamic</b>					
Ciss	-	637	-	pF	V <sub>DS</sub> =-10V, V <sub>GS</sub> =0V, f=1MHz
Coss	-	90	-		
Crss	-	72	-		
*td(ON)	-	6	-	ns	V <sub>DS</sub> =-15V, I <sub>D</sub> =-2A, V <sub>GS</sub> =-10V, R <sub>G</sub> =1 Ω
*tr	-	19.6	-		
*td(OFF)	-	54.4	-		
*tf	-	25	-		
*Qg	-	14.2	-	nC	V <sub>DS</sub> =-24V, I <sub>D</sub> =-2A, V <sub>GS</sub> =-10V
*Qgs	-	2	-		
*Qgd	-	3.1	-		
<b>Body Diode</b>					
*V <sub>SD</sub>	-	-0.86	-1.2	V	V <sub>GS</sub> =0V, I <sub>S</sub> =-4.5A
*trr	-	7.3	-	ns	I <sub>F</sub> =-4.5A, V <sub>GS</sub> =0V, dI <sub>F</sub> /dt=100A/μs
*Qrr	-	2.7	-	nC	

\*Pulse Test : Pulse Width ≤300μs, Duty Cycle≤2%

### Recommended Soldering Footprint

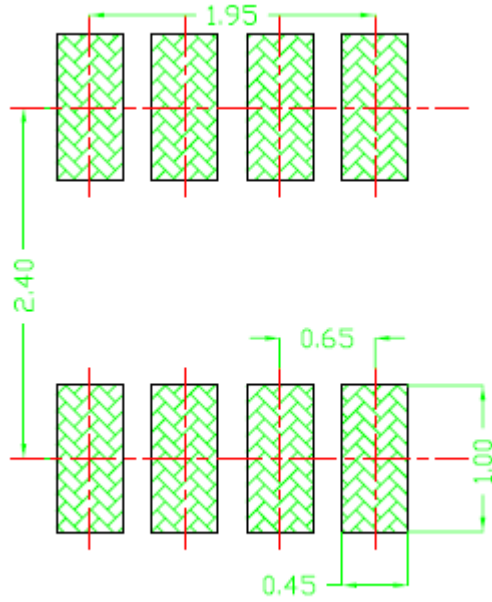

unit : mm



**Typical Characteristics : Q1( N-channel )**

Typical Output Characteristics

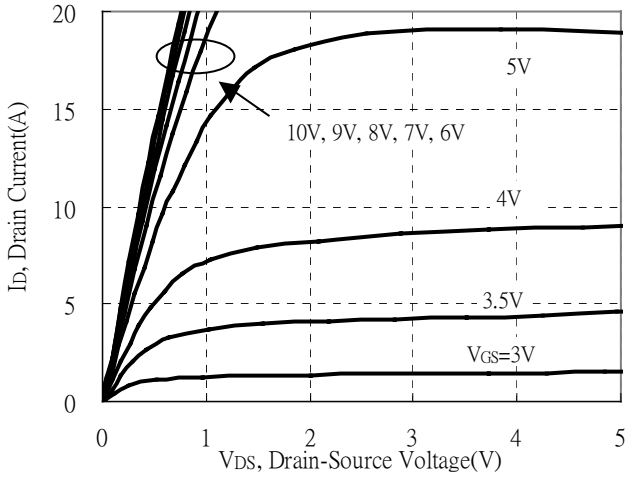

Brekdown Voltage vs Ambient Temperature

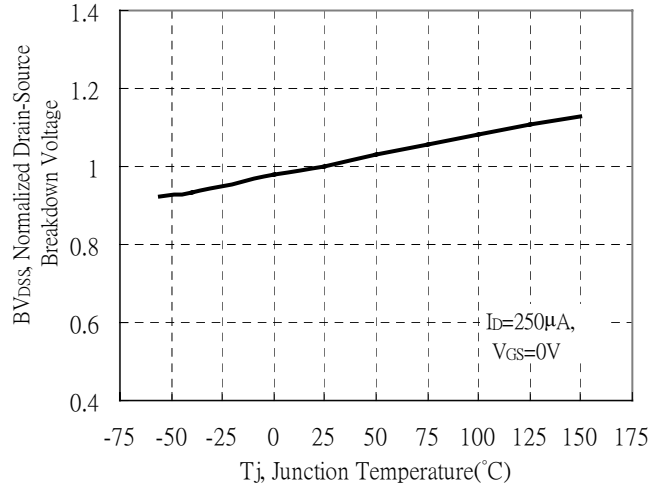

Static Drain-Source On-State resistance vs Drain Current

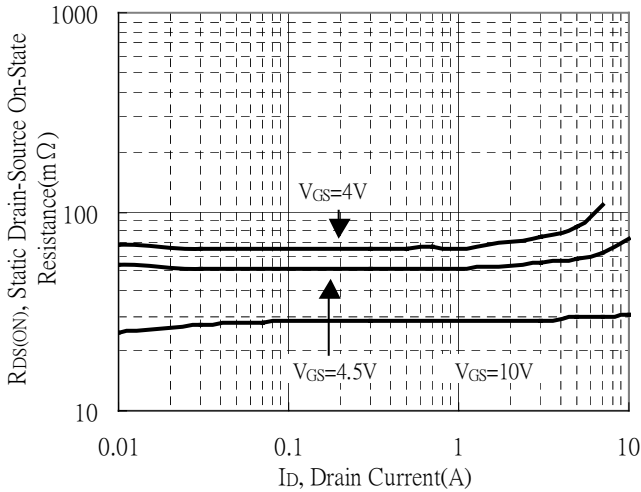

Reverse Drain Current vs Source-Drain Voltage

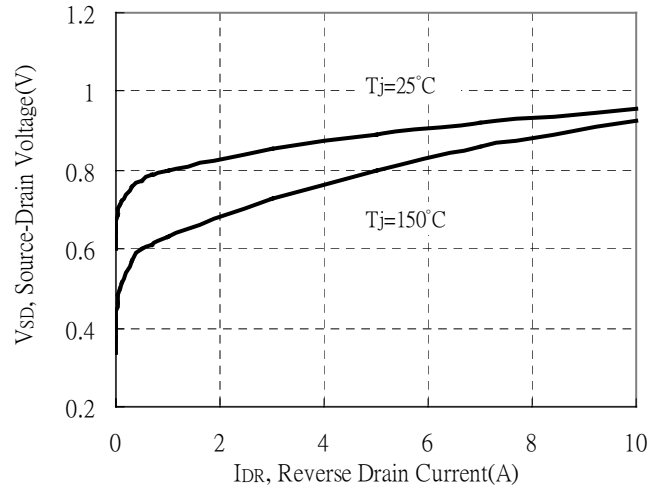

Static Drain-Source On-State Resistance vs Gate-Source Voltage

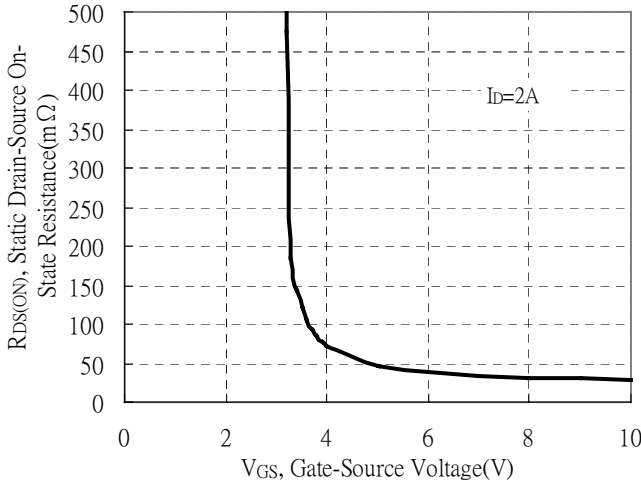

Drain-Source On-State Resistance vs Junction Temperature

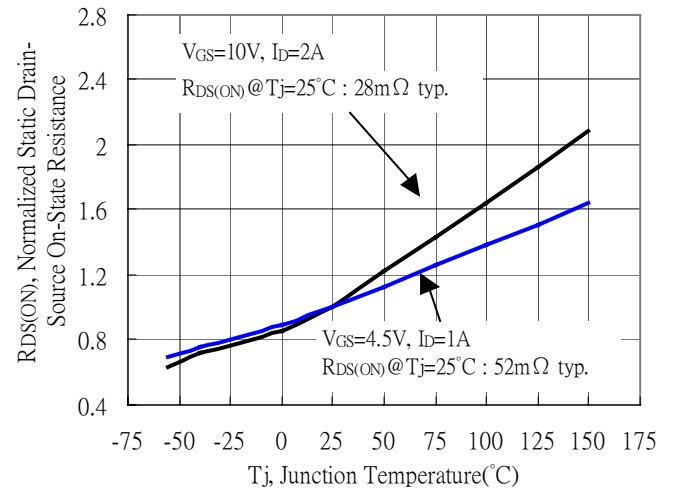

**Typical Characteristics(Cont.) : Q1( N-channel)**

Capacitance vs Drain-to-Source Voltage

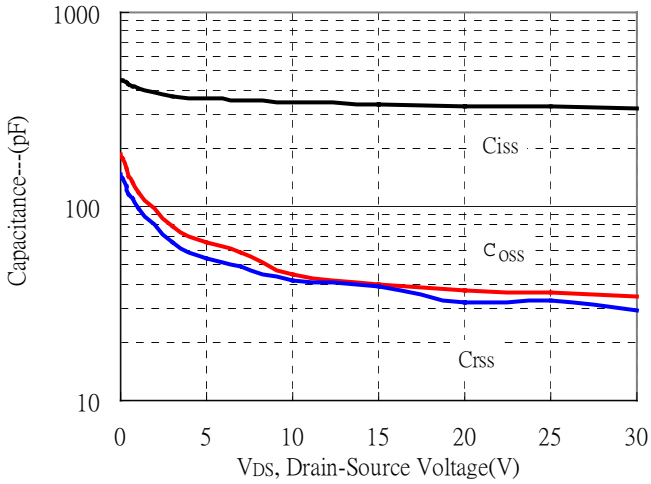

Threshold Voltage vs Junction Temperature

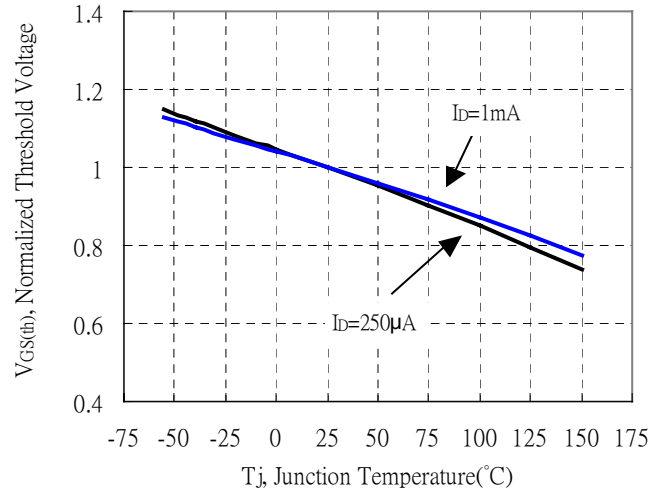

Forward Transfer Admittance vs Drain Current

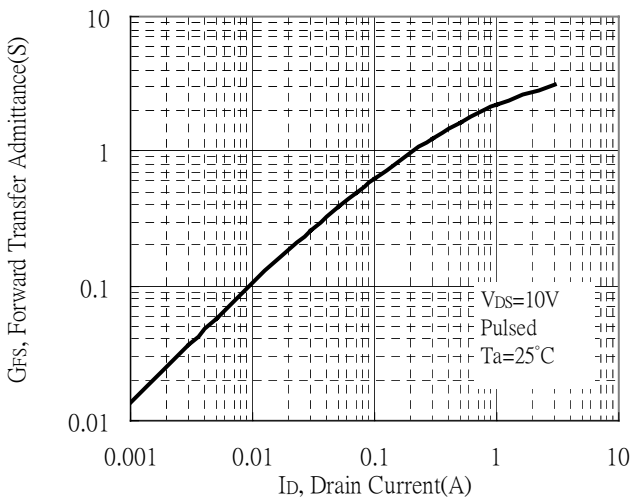

Gate Charge Characteristics

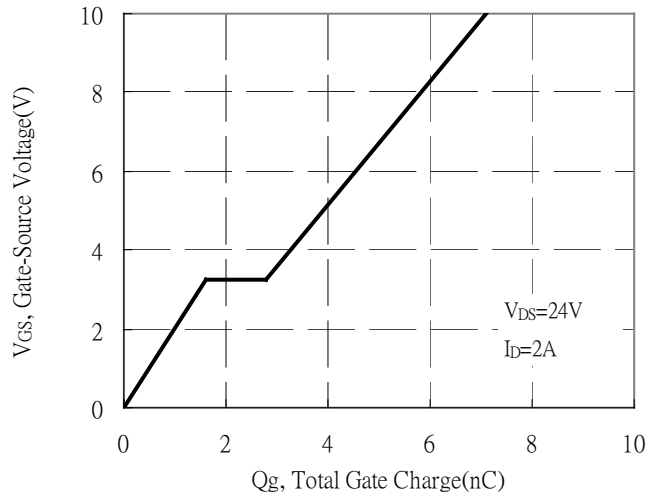

Maximum Safe Operating Area

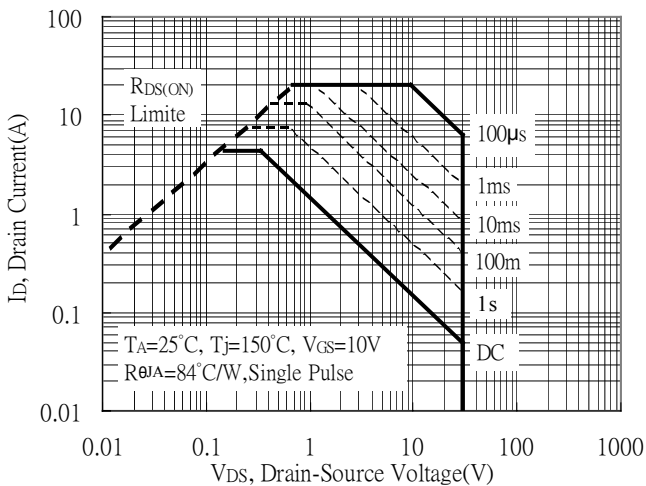

Maximum Drain Current vs Junction Temperature

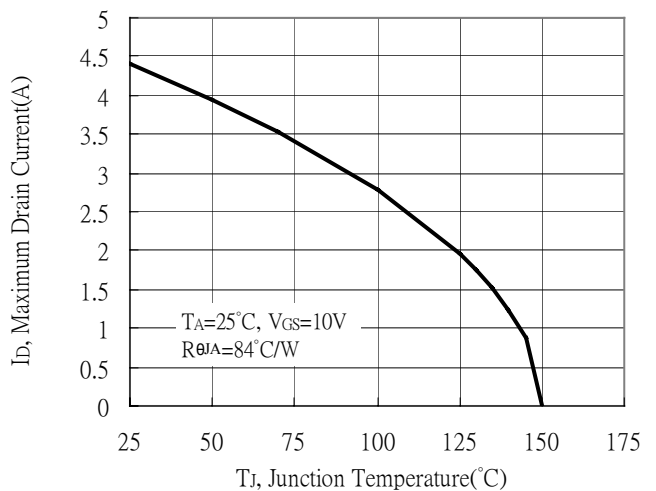



**Typical Characteristics(Cont.) : Q1( N-channel)**

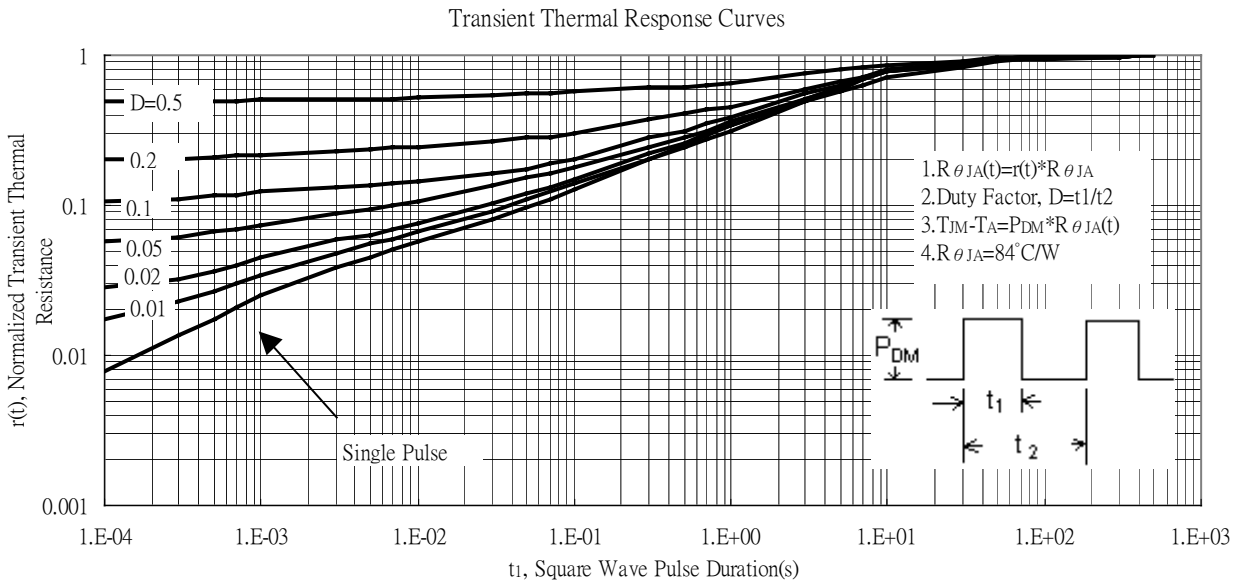
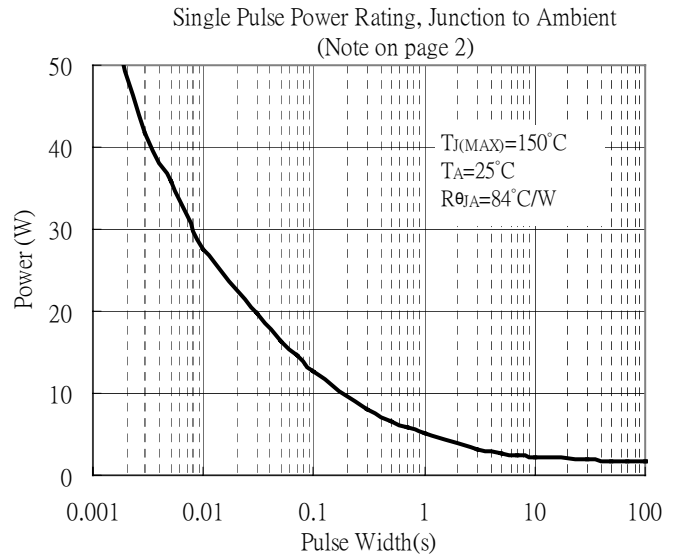
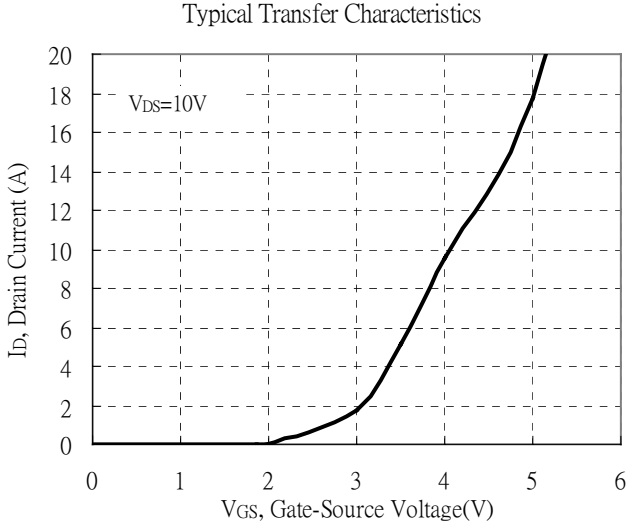

**Typical Characteristics : Q2( P-channel)**

Typical Output Characteristics

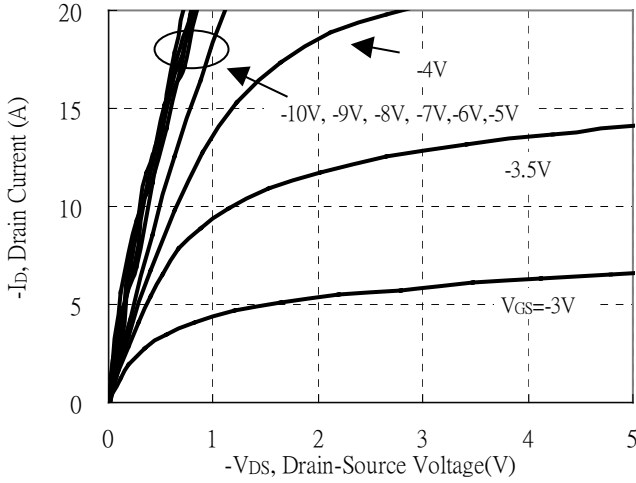

Breakdown Voltage vs Ambient Temperature

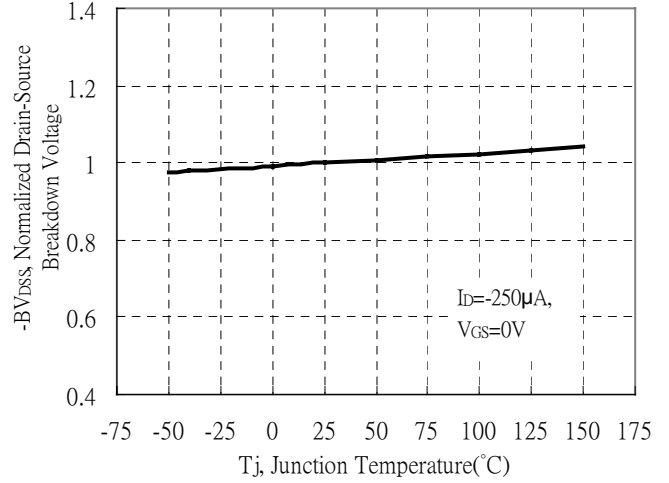

Static Drain-Source On-State resistance vs Drain Current

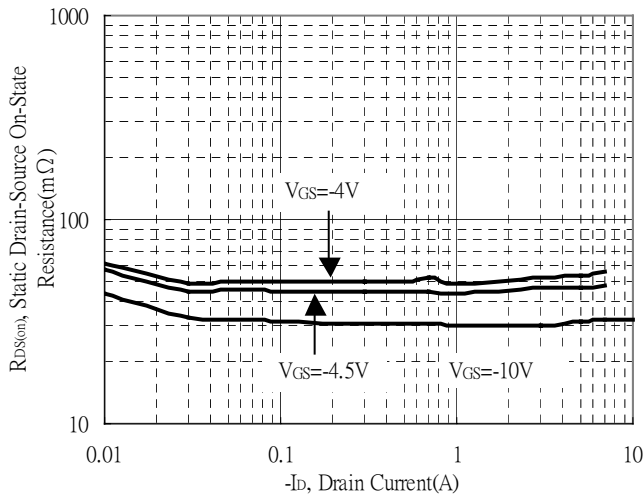

Source Drain Current vs Source-Drain Voltage

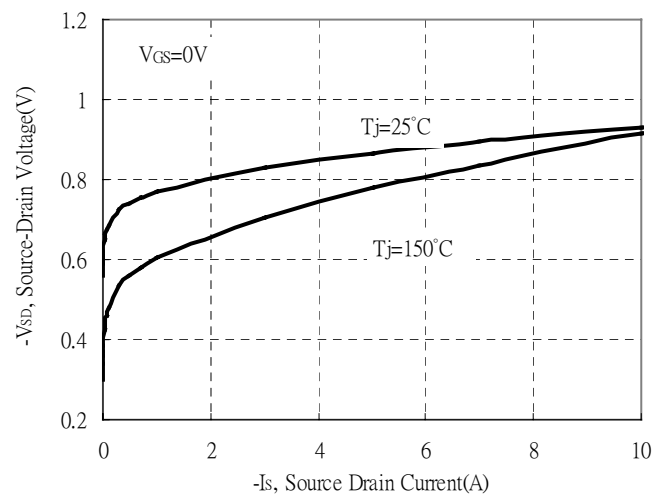

Static Drain-Source On-State Resistance vs Gate-Source Voltage

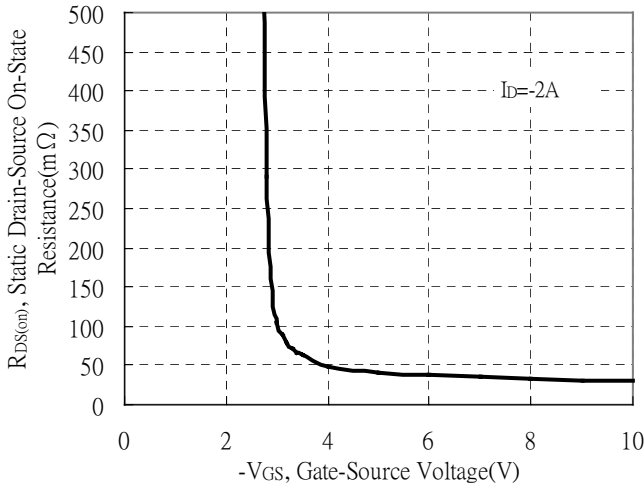

Drain-Source On-State Resistance vs Junction Temperature

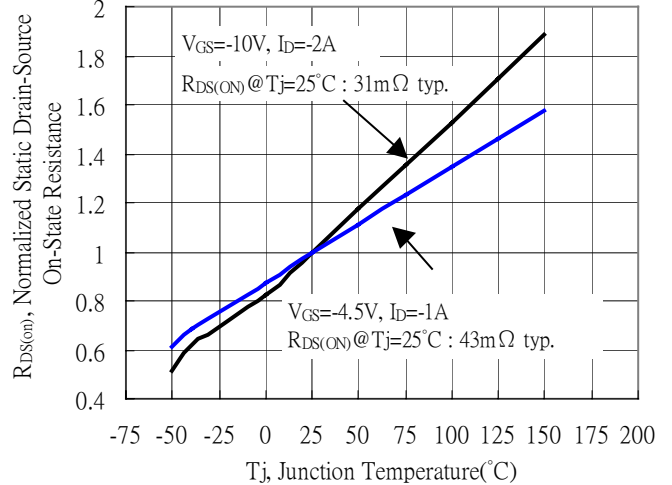



**Typical Characteristics(Cont.) : Q2(P-channel)**

Capacitance vs Drain-to-Source Voltage

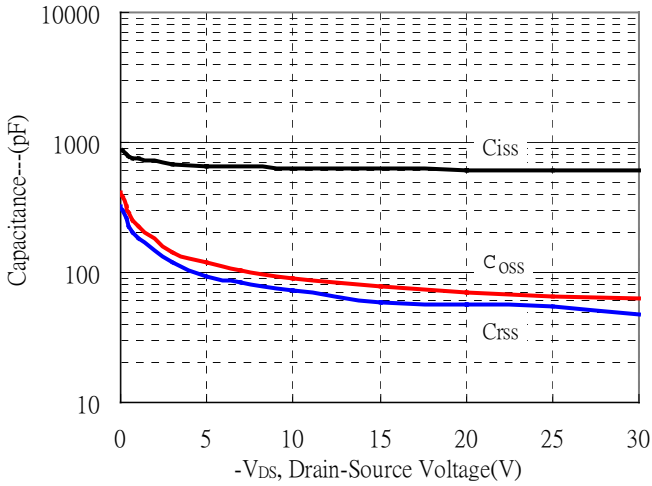

Threshold Voltage vs Junction Temperature

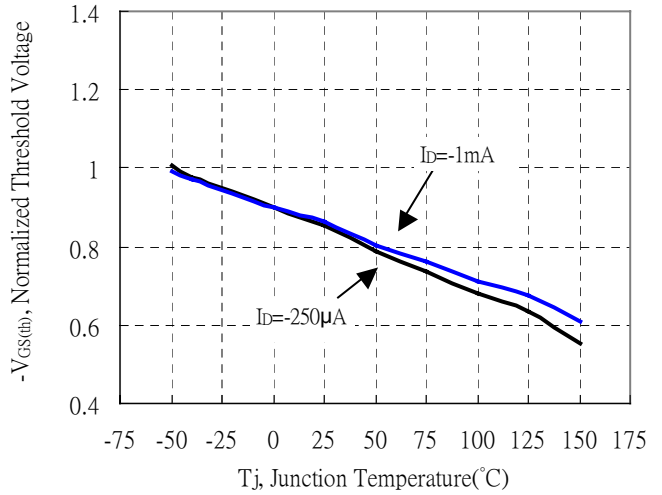

Forward Transfer Admittance vs Drain Current

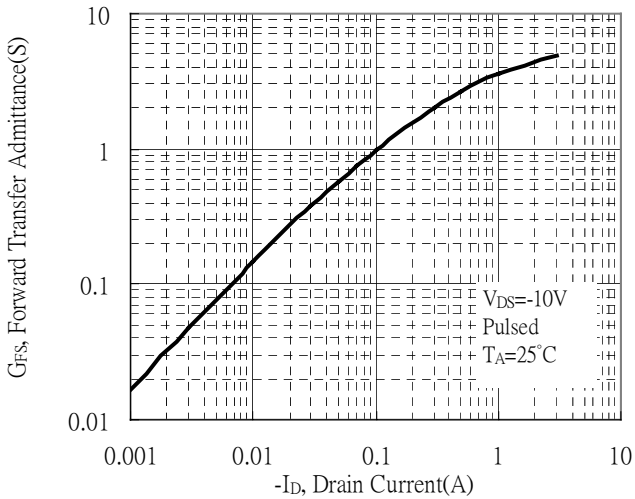

Gate Charge Characteristics

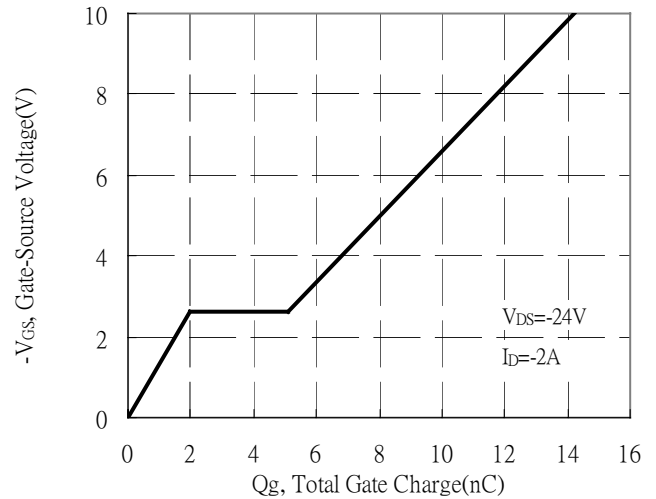

Maximum Safe Operating Area

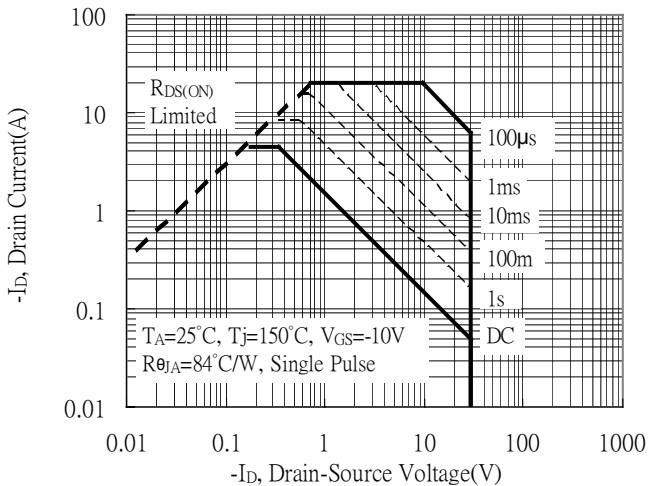

Maximum Drain Current vs Junction Temperature

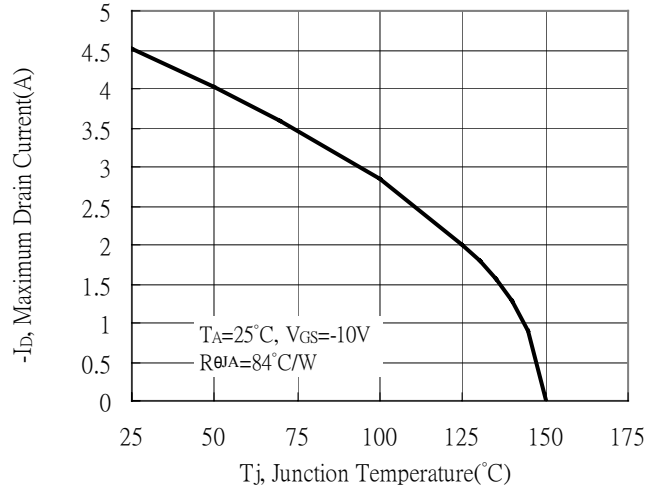



Typical Characteristics(Cont.) : Q2(P-channel)

Typical Transfer Characteristics

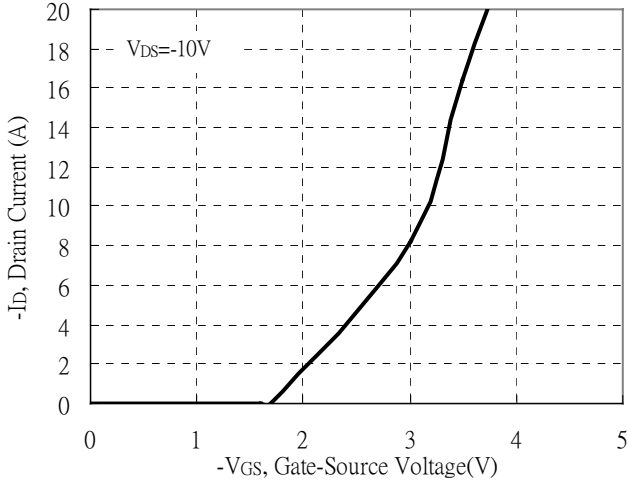

Single Pulse Power Rating, Junction to Ambient  
 (Note on page 2)

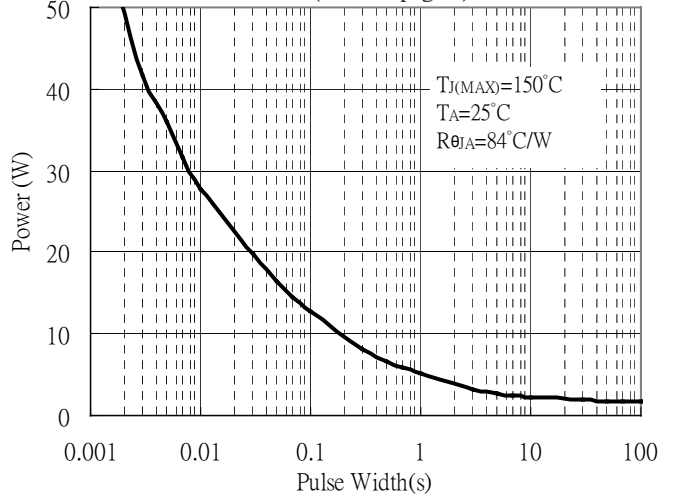

Transient Thermal Response Curves

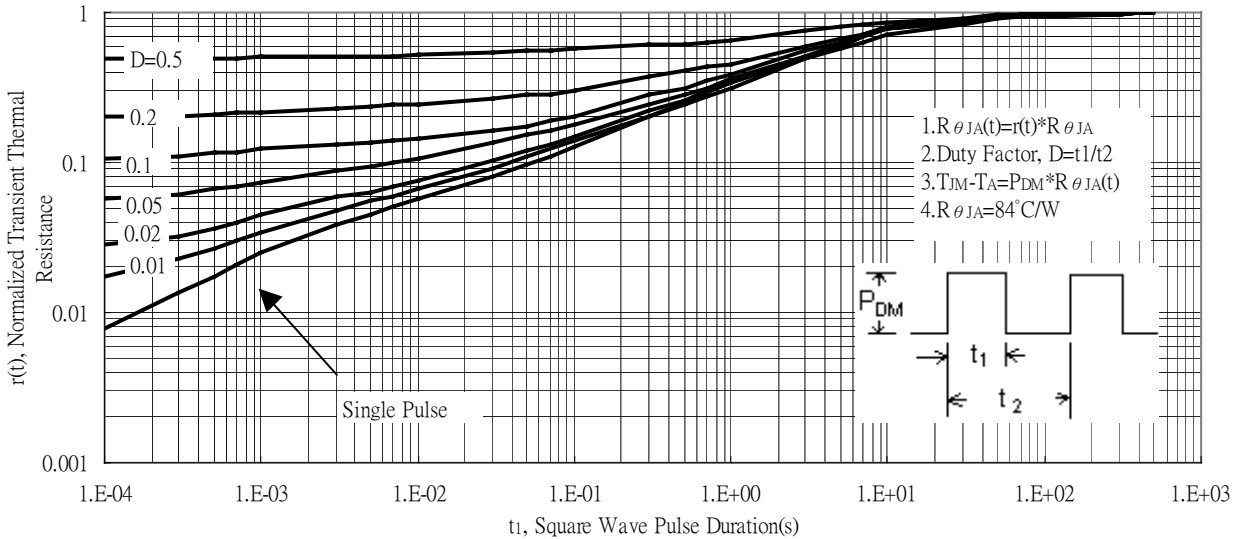

## Reel Dimension

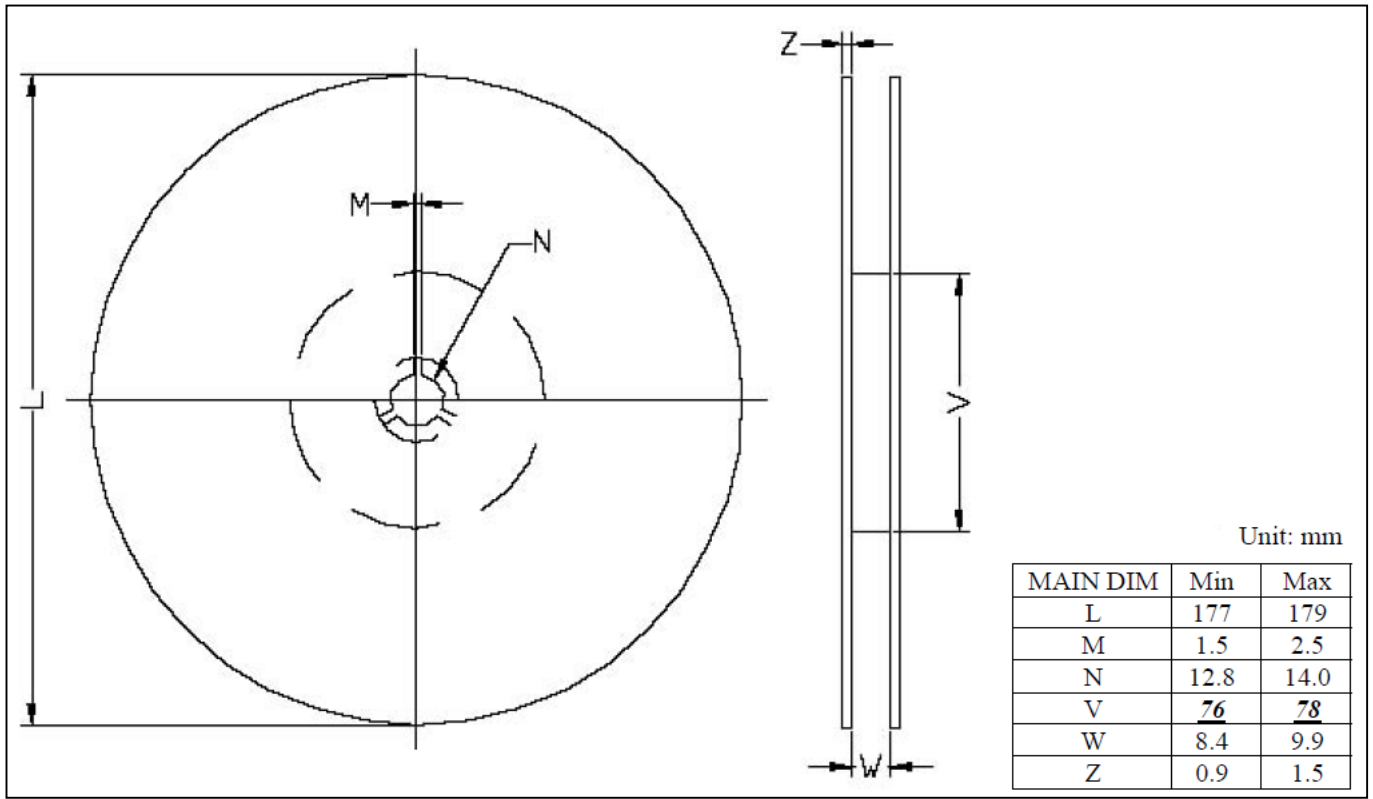

## Carrier Tape Dimension

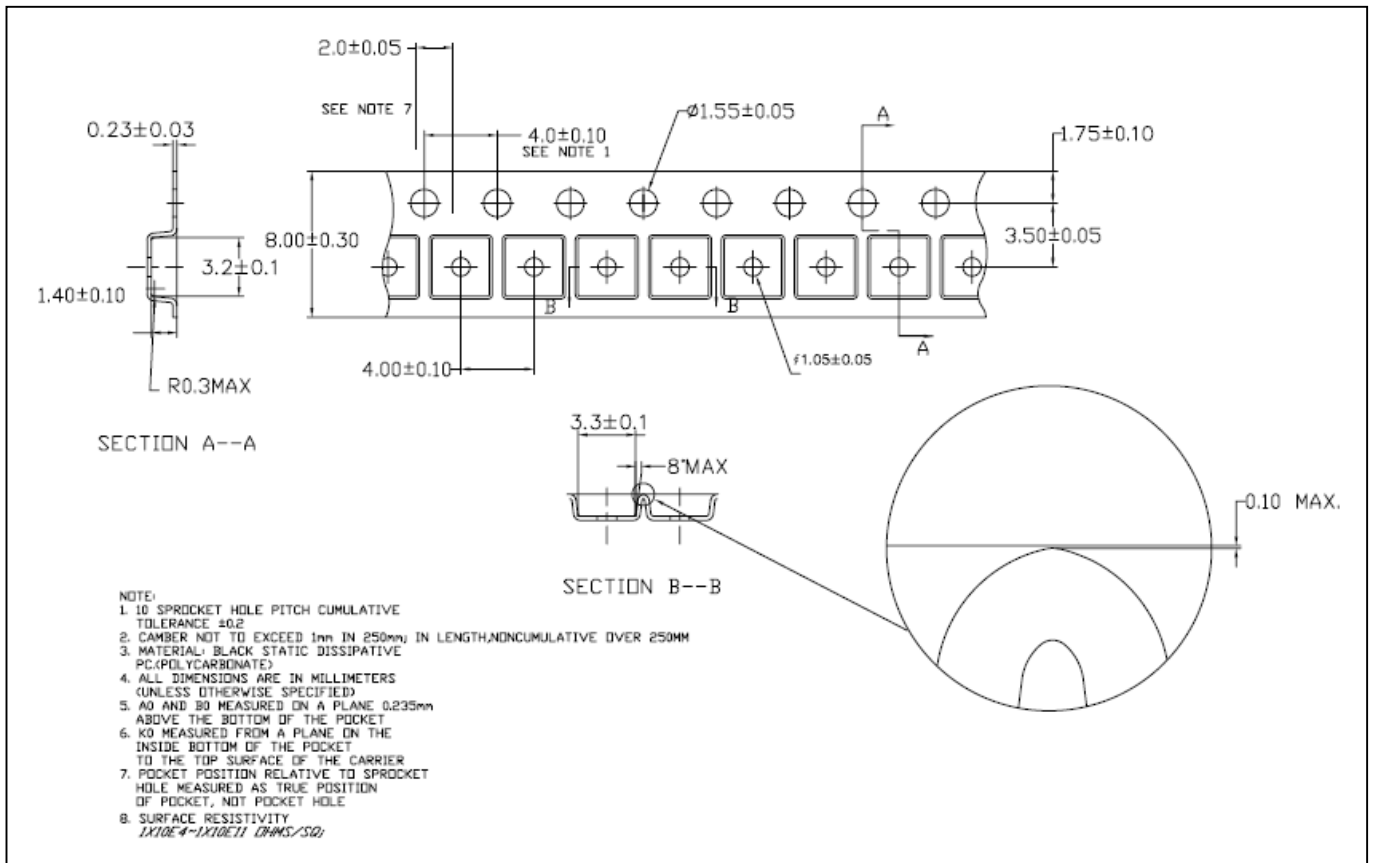

**Recommended wave soldering condition**

Product	Peak Temperature	Soldering Time
Pb-free devices	260 +0/-5 °C	5 +1/-1 seconds

**Recommended temperature profile for IR reflow**

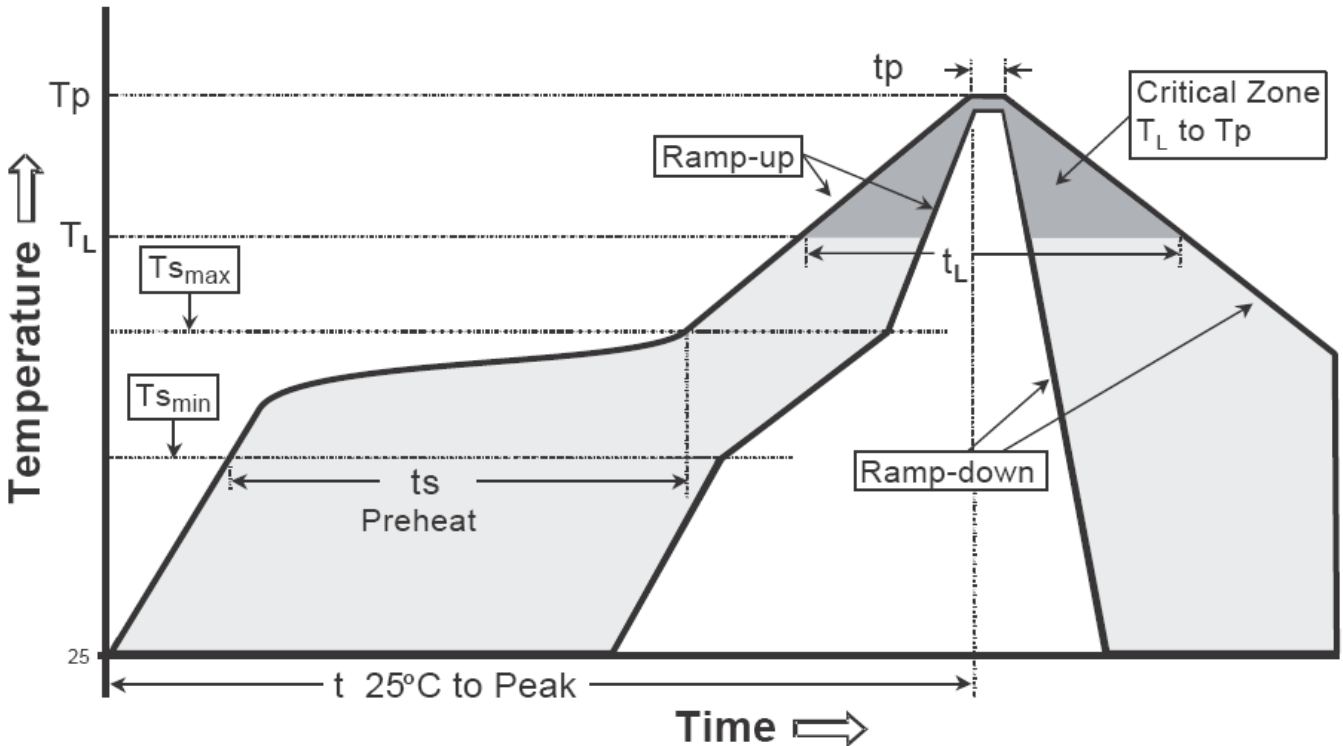

Profile feature	Sn-Pb eutectic Assembly	Pb-free Assembly
Average ramp-up rate (Tsmax to Tp)	3°C/second max.	3°C/second max.
Preheat		
-Temperature Min(Ts min)	100°C	150°C
-Temperature Max(Ts max)	150°C	200°C
-Time(ts min to ts max)	60-120 seconds	60-180 seconds
Time maintained above:		
-Temperature (TL)	183°C	217°C
- Time (tL)	60-150 seconds	60-150 seconds
Peak Temperature(TP)	240 +0/-5 °C	260 +0/-5 °C
Time within 5°C of actual peak temperature(tp)	10-30 seconds	20-40 seconds
Ramp down rate	6°C/second max.	6°C/second max.
Time 25 °C to peak temperature	6 minutes max.	8 minutes max.

Note : All temperatures refer to topside of the package, measured on the package body surface.

**2928-8J Dimension**

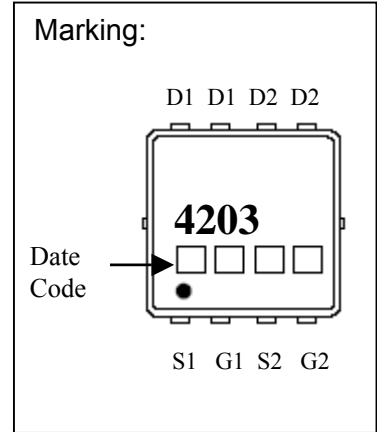
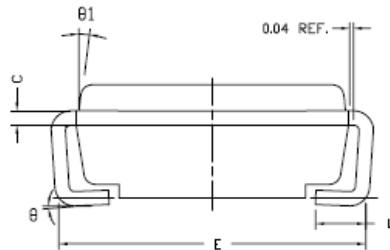
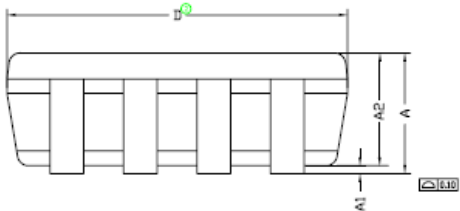
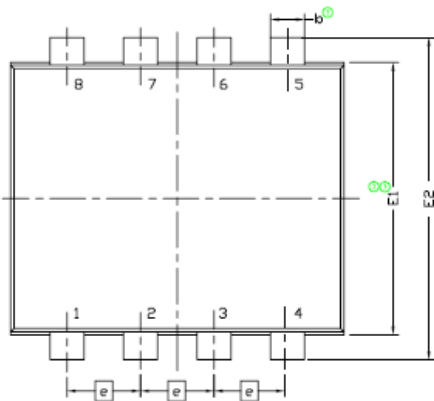

8-Lead 2928-8J Plastic Package  
 CYStek Package Code: N8J

**Note:**

1. All Dimension Are In mm.
2. Package Body Sizes Exclude Mold Flash, Protrusion Or Gate Burrs. Mold Flash, Protrusion Or Gate Burrs Shall Not Exceed 0.10 mm Per Side.
3. Package Body Sizes Determined At The Outermost Extremes Of The Plastic Body Exclusive Of Mold Flash, Tie Bar Burrs, Gate Burrs And Interlead Flash, But Including Any Mismatch Between The Top And Bottom Of The Plastic Body.
4. The Package Top May Be Smaller Than The Package Bottom.
5. Dimension "b" Does Not Include Dambar Protrusion. Allowable Dambar Protrusion Shall Be 0.08 mm Total In Excess Of "b" Dimension At Maximum Material Condition. The Dambar Cannot Be Located On The Lower Radius Of The Foot.

DIM	Millimeters		Inches		DIM	Millimeters		Inches	
	Min.	Max.	Min.	Max.		Min.	Max.	Min.	Max.
A	0.935	1.100	0.0368	0.0433	E1	2.300	2.500	0.0906	0.0984
A1	0.010	0.100	0.0004	0.0039	E2	2.650	3.050	0.1043	0.1201
A2	0.925	1.000	0.0364	0.0394	e	0.65 BSC		0.0256	BSC
b	0.250	0.400	0.0098	0.0157	L	0.300	0.600	0.0118	0.0236
c	0.100	0.200	0.0039	0.0079	θ	0°	8°	0°	8°
D	2.950	3.100	0.1161	0.1220	θ1	7° TYP		7° TYP	
E	2.500	3.000	0.0984	0.1181					

- Notes:**
1. Controlling dimension: millimeters.
  2. Maximum lead thickness includes lead finish thickness, and minimum lead thickness is the minimum thickness of base material.
  3. If there is any question with packing specification or packing method, please contact your local CYStek sales office.

**Material:**

- Lead: pure tin plated.
- Mold Compound: Epoxy resin family, flammability solid burning class: UL94V-0.

**Important Notice:**

- All rights are reserved. Reproduction in whole or in part is prohibited without the prior written approval of CYStek.
- CYStek reserves the right to make changes to its products without notice.
- CYStek **semiconductor products are not warranted to be suitable for use in Life-Support Applications, or systems.**
- CYStek assumes no liability for any consequence of customer product design, infringement of patents, or application assistance.