

## 5 Port 10M/100M Ethernet Switch

### FEATURES

- IEEE802.3 and IEEE802.3u compliant.
- Provide 4 RMI and 1 MII/RMII ports.
- Programmable 1K/8K MAC addresses filtering.
- Store and forward switching function and bad packet filtering function.
- Optional back\_pressure/802.3x flow control/flooding control/broadcast control.
- Optional EEPROM Interface for advanced switch configurations.
- 1MB/2MB SGRAM/SDRAM flexible memory interface.
- Port VLAN/trunking.
- Link/Rx activity, packet buffer utilization LED display.
- 50MHz for non-blocking for 5 ports switch operation
- Build in internal/external memory test function.
- 128 pin PQFP package, 3.3V operation voltage.

### GENERAL DESCRIPTION

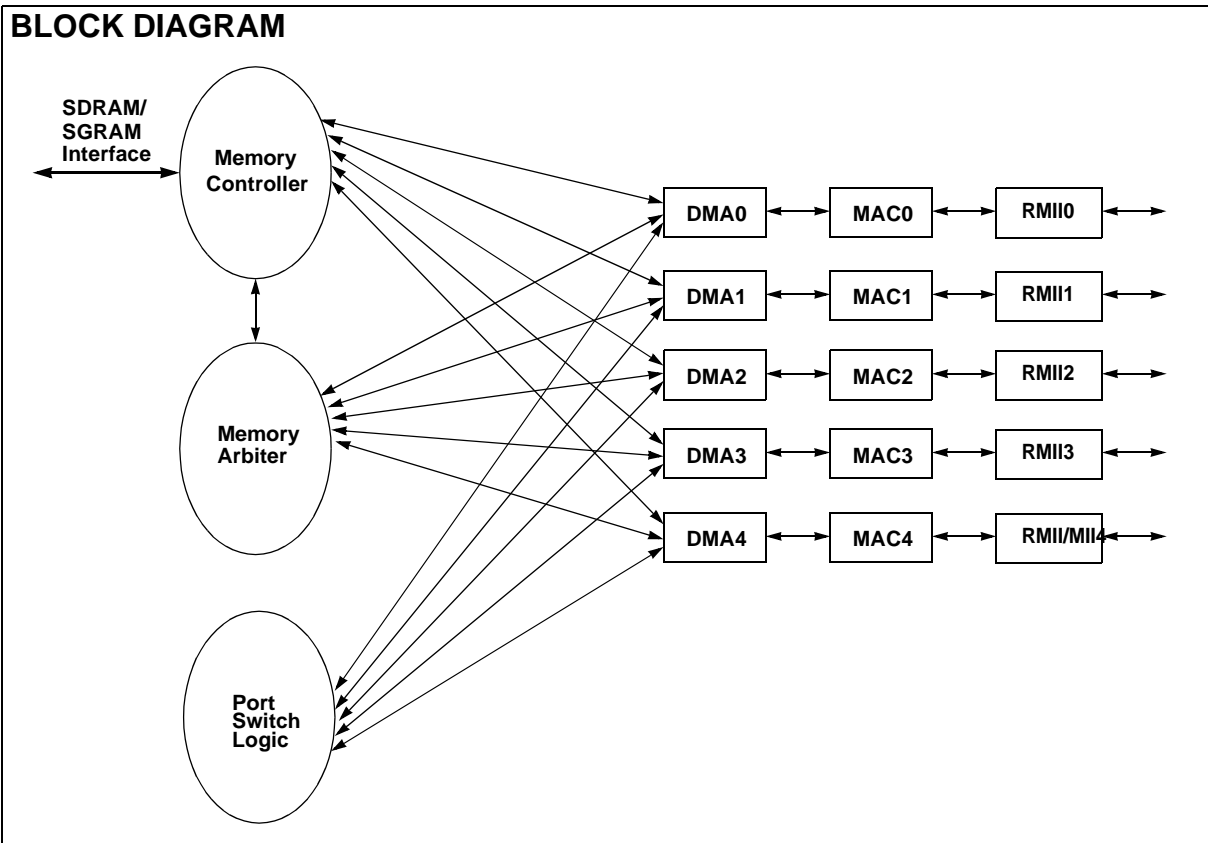
The MTD505 complies fully with the IEEE802.3, 802.3u and 802.3x specifications and is a non-blocking 5 port 10M/100M Ethernet switch device.

Support 4 RMI and 1 MII/RMII ports for 10M/100M operation. 1MByte/2MBytes memory interface provides maximum 1365 packet buffers for Ethernet packet buffering. Up to 8192 address entries are provided by the MTD505, and the MTD505 use full Ethernet address compare algorithm to minimize hashing collision events.

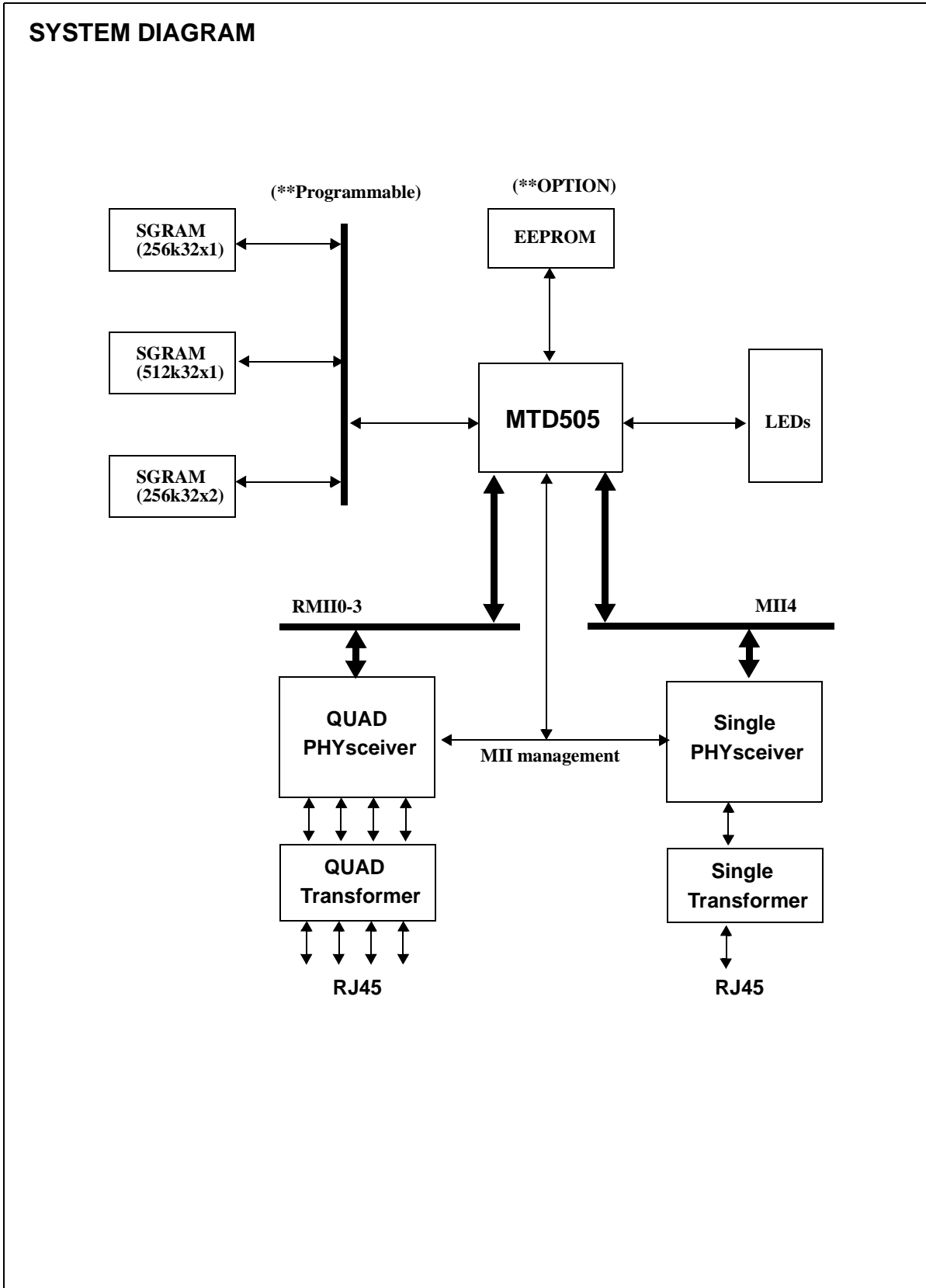
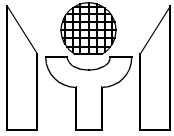
The MTD505 provides EEPROM interface to config port trunking, port VLAN, static entry, 802.3x flow control threshold, flooding port, broadcast control threshold. Each MTD505 port support 10/100M auto-negotiation by MDC/MDIO interface for connecting external PHY devices.

The MTD505 also provides 10 pins for Link/RX activity, packet buffer utilization LED display function.

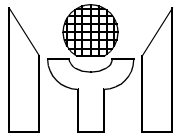
### BLOCK DIAGRAM



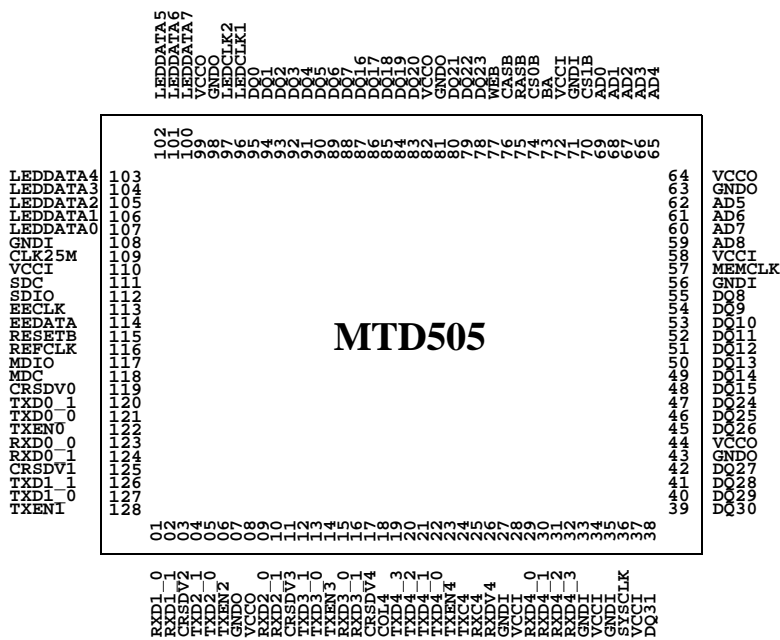
This datasheet contains new product information. Myson Technology reserves the rights to modify the product specification without notice. No liability is assumed as a result of the use of this products. No rights under any patent accompany the sales of the product.

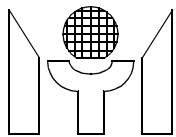


This datasheet contains new product information. Myson Technology reserves the rights to modify the product specification without notice. No liability is assumed as a result of the use of this products. No rights under any patent accompany the sales of the product



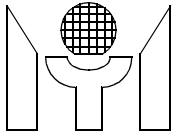
## 1.0 PIN CONNECTION





**2.0 PIN DESCRIPTIONS**

<b>RMII/MII Port Interface Pins</b>			
<b>Name</b>	<b>Pin Number</b>	<b>I/O</b>	<b>Descriptions</b>
CRSDV0	119	I	Port0 RMII receive interface signal, CRSDV0 is asserted high when port0 media is non_idle.
RXD0_0	123	I	Port0 RMII receive data bit_0.
RXD0_1	124	I	Port0 RMII receive data bit_1.
TXEN0	122	O	Port0 RMII transmit enable signal.
TXD0_0	121	O	Port0 RMII transmit data bit_0.
TXD0_1	120	O	Port0 RMII transmit data bit_1.
CRSDV1	125	I	Port1 RMII receive interface signal, CRSDV1 is asserted high when port1 media is non_idle.
RXD1_0	01	I	Port1 RMII receive data bit_0.
RXD1_1	02	I	Port1 RMII receive data bit_1.
TXEN1	128	O	Port1 RMII transmit enable signal.
TXD1_0	127	O	Port1 RMII transmit data bit_0.
TXD1_1	126	O	Port1 RMII transmit data bit_1.
CRSDV2	03	I	Port2 RMII receive interface signal, CRSDV2 is asserted high when port2 media is non_idle.
RXD2_0	09	I	Port2 RMII receive data bit_0.
RXD2_1	10	I	Port2 RMII receive data bit_1.
TXEN2	06	O	Port2 RMII transmit enable signal.
TXD2_0	05	O	Port2 RMII transmit data bit_0.
TXD2_1	04	O	Port2 RMII transmit data bit_1.
CRSDV3	11	I	Port3 RMII receive interface signal, CRSDV0 is asserted high when port3 media is non_idle.
RXD3_0	15	I	Port3 RMII receive data bit_0.
RXD3_1	16	I	Port3 RMII receive data bit_1.
TXEN3	14	O	Port3 RMII transmit enable signal.
TXD3_0	13	O	Port3 RMII transmit data bit_0.
TXD3_1	12	O	Port3 RMII transmit data bit_1.
CRSDV4	17	I	Port4 RMII/MII receive interface signal, CRSDV4 is asserted high when port4 media is non_idle.
RXDV4	26	I	Port4 MII receive data valid. In RMII mode, this pin don't use.
RXCLK4	25	I	Port4 MII receive clock signal. In RMII mode, this pin is not used.
RXD4_3	32	I	Port4 MII receive data bit_3. In RMII mode, this pin don't use.
RXD4_2	31	I	Port4 MII receive data bit_2. In RMII mode, this pin don't use.
RXD4_0	29	I	Port4 RMII/MII receive data bit_0.
RXD4_1	30	I	Port4 RMII/MII receive data bit_1.
TXEN4	23	O	Port4 RMII transmit enable signal.
TXCLK4	24	I	Port4 RMII transmit clock signal. In RMII mode, this pin is not used.

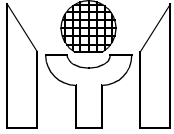


<b>RMII/MII Port Interface Pins</b>			
<b>Name</b>	<b>Pin Number</b>	<b>I/O</b>	<b>Descriptions</b>
TXD4_3	19	O	Port4 MII transmit data bit_3. In RMII mode, this pin don't use.
TXD4_2	20	O	Port4 MII transmit data bit_2. In RMII mode, this pin don't use.
TXD4_0	22	O	Port4 RMII/MII transmit data bit_0.
TXD4_1	21	O	Port4 RMII/MII transmit data bit_1.
COL4	18	I	Port4 MII collision input. In RMII mode, this pin don't use.
CLK25M	109	O	Port4 MII 25MHz clock output.

<b>SGRAM/SDRAM Interface Pins</b>			
<b>Name</b>	<b>Pin Number</b>	<b>I/O</b>	<b>Descriptions</b>
AD[8:0]	59,60,61,62, 65,66,67,68, 69	O	Memory row/column address bus outputs AD[7:0] are row/column address [7:0]. AD[8] : This pin should connect to SGRAM/SDRAM MSB address bit.
DQ[31:0]	38~42,45~55, 78~80, 83~95	I/O	Memory data bus
RASB	75	O	SGRAM/SDRAM row address select
CASB	76	O	SGRAM/SDRAM column address select
WEB	77	O	SGRAM/SDRAM write enable
BA	73	O	SGRAM/SDRAM bank select
CS0B	74	O	Memory chip select 0
CS1B	70	O	Memory chip select 1
MEMCLK	57	O	Memory clock output.

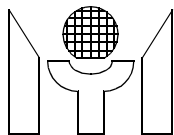
Note: SGRAM/SDRAM access time: 10 ns (max)

<b>LED Interface Pins</b>			
<b>Name</b>	<b>Pin Number</b>	<b>I/O</b>	<b>Descriptions</b>
LEDDATA [7:0]	100,101,102, 103,104,105, 106,107	I/O	LED data output. These LED pins report Port0~7 Link/Rx activity status using LEDCLK1 strobe , and report packet buffer utilization status using LEDCLK2 strobe.  LEDDATA [0] [1] [2] [3] [4] [5] [6] [7] LEDCLK1 LR0 LR1 LR2 LR3 LR4 --- --- --- LEDCLK2 Uti0 Uti1 Uti2 Uti3 Uti4 --- BFull MFail  note: LRn: means per port's Link_RxAct status. Uti0: 5%, Uti1: 10%, Uti2: 20%, Uti3: 35%, Uti4: 50 above . BFull: Buffer almost full alarm signal. Mfail: External memory poer on test failure.

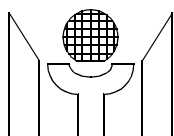


<b>LED Interface Pins</b>			
<b>Name</b>	<b>Pin Number</b>	<b>I/O</b>	<b>Descriptions</b>
LEDCLK1	96	I/O	LED strobe 1
LEDCLK2	97	I/O	LED strobe 2

<b>Miscellaneous Pins</b>			
<b>Name</b>	<b>Pin Number</b>	<b>I/O</b>	<b>Descriptions</b>
RESETB	115	I	System reset input, low active.
SYSCLK	36	I	Switch core system clock input, using the same clock source with REFCLK.
REFCLK	116	I	RMII reference clock input, using 50Mhz.
MDC	118	I/O	MII management clock inout
MDIO	117	I/O	MII management data inout
SDC	111	I/O	MII register clock inout
SDIO	112	I/O	MII register data inout
EEDATA	114	I/O	EEPROM data input
EECLK	113	I/O	EEPROM clock output
VCC	08,28,34,37, 44,58,64,72, 82,99,110	PWR	Power pins
GND	02,27,33,35, 43,56,63,71, 81,98,108	GND	Ground pins

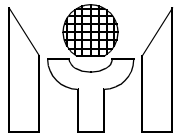


<b>Jumpper Configuration After Power On Reset</b>			
<b>Name</b>	<b>Pin Number</b>	<b>I/O</b>	<b>Descriptions</b>
LEDDATA[0] LEDDATA[1] LEDDATA[2] LEDDATA[3] LEDDATA[4] LEDDATA[5] LEDDATA[6] LEDDATA[7]		I/O	<p>During power on reset duration, these pins are jumper setting pins (pull_hgih = 1, pull_low = 0).</p> <p>LEDDATA[0] : select SGRAM/SDRAM interface ,            “1” means 256K32 x 1 or 512K32 x 1 is selected.            “0” means 256K32 x 2 is selected, default is “1”.</p> <p>LEDDATA[1] : config packet buffer size,            “1” means 2 M bytes buffer size is selected.            “0” means 1 M byte buffer size is selected, default is “0”</p> <p>LEDDATA[2] : enable memory test function,            “1” means enable.            ‘0” means disable, default is “1”.</p> <p>LEDDATA[3] : enable aging function,            “1” means enable.            “0” means disable, default is “1”.</p> <p>LEDDATA[4] : enable MII polling(MDC/MDIO),            “1” means enable.            “0” means disable, default is “1”.</p> <p>LEDDATA[5] : enable broadcast storm control,            “1” means enable.            “0” means disable, default is “1”.</p> <p>LEDDATA[6] : enable backpressure function (in half mode),            “1” means enable.            “0” means disable, default is “1”.</p> <p>LEDDATA[7] : enable 802.3x flow control function (in full mode) ,            “1” means enable.            “0” means disable, default is ”1”.</p>
LEDCLK1		I/O	<p>During power on reset duration, this pin is a jumper setting pin (pull_high=1, pull_low = 0).</p> <p>LEDCLK1 : select 1K or 8K address entry table,            “1” means 8K address entry is selected.            “0” means 1K address entry is selected, default is “1”.</p>
LEDCLK2		I/O	<p>During power on reset duration, this pin is a jumper setting pin (pull_high=1, pull_low = 0).</p> <p>LEDCLK2 : enable EEPROM interface.            “1” means enable.            “0” means disable, default is “1”.</p>



<b>Jummper Configuration After Power On Reset</b>			
<b>Name</b>	<b>Pin Number</b>	<b>I/O</b>	<b>Descriptions</b>
EEDATA		I/O	During power on reset duration, this pin is a jumper setting pin (pull_hgh =1, pull_low = 0). EEDATA : enable EEPROM auto_load configuration function while EEPROM interface is enabled, “1” means enable. “0” means disable, default is “1”.
TXEN[2:0]		I/O	During power on reset duration, this pin is a jumper setting pin (pull_hgh =1, pull_low = 0). TXEN[2:0] : uplink port (flooding port) 0 ~7 selection; default is “000”.
TXEN[3]		I/O	During power on reset duration, this pin is a jumper setting pin (pull_hgh =1, pull_low = 0). TXEN[3] : enable flooding control, “1” means enable. “0” means disable, default is “0”.
TXEN[4]		I/O	During power on reset duration, this pin is a jumper setting pin (pull_hgh =1, pull_low = 0). TXEN[4] : enable VLAN tag 1522 bytes receiving, “1” means enable. “0” means disable, default is “0”.
SDC		I/O	During power on reset duration, this pin is a jumper setting pin (pull_hgh =1, pull_low = 0). SDC : Port4 MII/RMII interface selection, “1” means Port4 MII interface is selected. “0” means Port4 RMII interface is selected, default is “0”.
EECLK		I/O	During power on reset duration, this pin is a jumper setting pin (pull_hgh =1, pull_low = 0). EECLK : scan mode enable for debugging purpose, “1” means scan mode enable. “0” means scan mode disable, default is “0”.
MDC		I/O	During power on reset duration, this pin is a jumper setting pin (pull_hgh =1, pull_low = 0). MDC : fast mode enable for testing purpose, “1” means fast mode enable. “0” means fast mode disable, default is “0”.





### 3.0 FUNCTIONAL DESCRIPTIONS

The MTD505 is an 5 ports 10/100 Mbps fast Ethernet switch controller. It is a low cost solution for eight ports fast Ethernet SOHO switch design. No CPU interface is required; After power on reset, MTD505 provide an auto load configuration setting function through a 2 wire serial EEPROM interface to access external EEPROM device, and MTD505 can easily be configured to support port\_trunking, port\_VLAN, static entry, 802.3X flow control threshold setting, flooding port assignment ...etc functions. The following descriptions are MTD505's major functional blocks overview.

#### 3.1 Packet store and forwarding

The MTD505 use simple store and forward algorithm as packet switching method. Input packet from ports will be stored to external memory first, while packet is good for forward (CRC check ok, 64Bytes < length < 1518Bytes, not local packets, in the same VLAN group), if this packet's DA hits, then forward this packet to the destination port, otherwise this packet will be broadcasted.

#### 3.2 Learning and Routing

The MTD505 supports 1K or 8K MAC entries for switching. Dynamic address learning is performed by each good unicast packet is completely received. The static address learning is achieved by EEPROM configuration. On the other hand, the routing process is performed whenever the packet's DA is captured. If the DA can not get a hit result, the packet is going to switch broadcast or forward to the dedicated port according to the flooding control selection.

#### 3.3 Aging

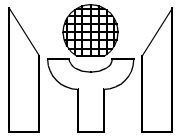
Only the dynamic address entries are scheduled in the aging machine. If one station does not transmit any packet for a period of time, the belonging MAC address will be kicked out from the address table. The aging out time can be program through the EEPROM auto load configuration. (Default value is 300 seconds)

#### 3.4 Buffer Queue Management

The buffer queue manager is implemented to manage the external shared memory (use SDRAM/SGRAM) for packet buffering. The main function of the buffer queue manager is to maintain the linked list consists of buffer IDs, which is used to show the corresponding memory address for each incoming packet. In addition, the buffer queue manager monitors the rested free spaces status of the external memory, If the packet storage achieve the predefined threshold value, the buffer queue manager will raise the alarm signal which is used to enable the flow control mechanism for avoiding transmission ID queue overflow happening. MTD505 provide 802.3x flow control in full duplex mode and back pressure control in half duplex mode.

#### 3.5 Full Duplex 802.3x Flow Control

In full duplex mode, MTD505 supports the standard flow control defined in IEEE802.3x standard. It enables the stopping of remote node transmissions via a PAUSE frame information interaction. When the "802.3x flow control enable" bit is set during power on reset (LEDDATA[7] pin is external pull\_high), it enables MTD505 supporting 802.3x flow control function in full\_duplex mode; When output port buffer queue's on\_using value reach the initialization setting threshold value (recommended Xon\_TH = 74'h when using 2Mbytes external memory; Xon\_TH = 2e'h when using 1Mbytes external memory), MTD505 will send out a PAUSE packet with pause time equal to FFF to stop the remote node transmission; When the output port buffer queue's on\_using value reduce to the initialization threshold value (recommended Xoff\_TH = 30'h when using 2Mbytes external memory; Xoff\_TH=18'h when using 1Mbytes external memory), MTD505 will also send a PAUSE packet with pause time equal to zero to inform the remote node to retransmit packet.



### 3.6 Half Duplex Back Pressure Control

In half duplex mode, MTD505 provide a back pressure control mechanism to avoid dropping packets during network conjection situation. When the “back pressure control enable” bit is set during power on reset (LEDDATA[6] pin is external pull\_high), it enables MTD505 supporting back pressure function in half\_duplex mode; When output port buffer queue’s on\_using value reach the initialization setting threshold value (same with the Xon\_TH value), MTD505 will send a JAM pattern in the input port when it senses an incoming packet , thus force a collision to inform the remote node transmission back off and will effectively avoid dropping packets. If the “back pressure control enable” bit is not set, and there is no free buffer queue available for the incoming packets, the incoming packets will be dropped.

### 3.7 MII Polling

The MTD505 supports PHY management through the serial MDIO/MDC interface. After power on reset, the MTD505 write related abilities to the advertisement register 4 of connected PHY devices and restart the auto\_negotiation pcedure via MDIO/MDC interface using the predefined PHY addresses increasingly from “01000”b to “01100”b. The MTD505 will periodically and continuously poll and update the link status and link partner’s ability which include speed, duplex mode, and 802.3x flow control capable status of the connected PHY devices through MDIO/MDC serial interface.

### 3.8 MAC and DMA engine

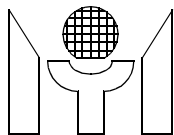
The MTD505’s MAC performs all the functions in IEEE802.3 protocol, such as frame formatting, frame stripping, CRC checking, bad packet dropping, defering to line traffic, and collision handling. The MAC Rx\_engine checks incoming packets and drops the bad packet which include CRC error, alignment error, short packet (less than 64 bytes), and long packet(more than 1518 bytes or 1522 bytes when the “VLAN tag 1522 bytes receive enable” bit is set during power on reset). Before transmission, The MAC Tx\_engine will constantly monitor the line traffic using derfering pcedure. Only if it has been idle for a 96 bits time (a minimum interpacket gap time, IPG time), actual transmsmission can be started. For the half duplex mode, MAC engine will detect collision; if a collision is detected, the MAC Tx\_engine will transmit a JAM pattern and then delay the re\_transmission for a random time period determined by the back\_off algorithm (MTD505 implements the truncated exponential back\_off algorithm defined in IEEE 802.3 standard). For the full duplex mode, collision signal is ignored.

The MTD505’s DMA engine performs the packets non\_blocking transportation between MAC engine and external memory according to a high speed switching pcedure. The switching pcedure is completed by address learning/routing process and buffer queue management operation.

### 3.9 EEPROM interface

MTD505 provide an auto load configuration setting function through a 2 wire serial EEPROM interface to acess external EEPROM device(24C02) after power on reset . MTD505 can easily be configured to support port\_trunking, port\_VLAN, static entry, 802.3X flow control threshold setting , flooding port assignment ...etc functions. The following table is the EEPROM contents mapping:

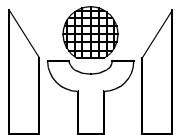
Name	EEPROM Address	EEPROM Content Description	Recommended Value Under Basic Operation
EOB	00	Last EEPROM content address value	8’h13
AgeLow	01	Aging Time bit [7:0]	8’h2c
AgeHigh	02	Aging Time bit [15:8]	8’h01
VLAN0	03	Port0 VLAN register	8’hfe
VLAN1	04	Port1 VLAN register	8’hfd
VLAN2	05	Port2 VLAN register	8’hfb
VLAN3	06	Port3 VLAN register	8’hf7
VLAN4	07	Port4 VLAN register	8’hef



Name	EEPROM Address	EEPROM Content Description	Recommended Value Under Basic Operation
Reserved	08	reserved	8'hdf
Reserved	09	reserved	8'hbf
Reserved	0a	reserved	8'h7f
UpLink10	0b	bit[7:4] --- the flooding port_no of Port1 bit[3:0] --- the flooding port_no of Port0 *ex1: bit[7:4] = "0011"b, means that if the incomin packet of Port1 got the "un_routed" result, then this incoming packet will be flooded to Port3. *ex2: bit[3:0] = "0111"b, means that if the incomin packet of Port0 got the "un_routed" result, then this incoming packet will be flooded to Port7. (note: set value "4'hf", means flooding to all the other ports; set value "4'h8"~"4'he" is forbidden)	8'h0f
UpLink32	0c	bit[7:4] --- the flooding port_no of Port3 bit[3:0] --- the flooding port_no of Port2 (note: set value "4'hf", means flooding to all the other ports; set value "4'h8"~"4'he" is forbidden)	8'h00
UpLink54	0d	bit[7:4] --- reserved bit[3:0] --- the flooding port_no of Port4 (note: value setting "f", means flooding to all the other ports; value setting "8" ~ "e" is forbidden)	8'h00
Reserved	0e	reserved	8'h00
Broadcast TH	0f	Broadcast threshold	8'hff
Xon TH	10	Xon threshold	8'h74
Xoff TH	11	Xoff threshold	8'h30
DisPort	12	Disable Port	8'h00
System Control	13	System control byte : bit[0] --- enhanced back pressure enable, bit[7:1] --- reserved.	8'h00
Reserved	14 ~1f	none	
StaticSA1	20 ~26	Address 26 bit[2:0] --- means Port ID Address 25 bit[7:0] ~ Address 20 bit[7:0] --- means static SA[47:0]	
StaticSA2	27 ~ 2d	Address 2d bit[2:0] --- means Port ID Address 2c bit[7:0] ~ Address 27 bit[7:0] --- means static SA[47:0]	

### 3.10 Port Based VLAN

The MTD505 supports VLAN configuration by port based methodology. One port select the certain ports to form its VLAN group by configuring the VLAN register. The packet (including broadcast packet) is not forwarding to the destination port whose VLAN group is different from the source port.



### 3.11 Port Trunking

The port trunking function can also be implemented by VLAN registers. One trunk port isolates the packet transmitting and receiving from the other trunk ports, which performs a logical trunk topology. The non-trunk port should choose only one trunk port for transmitting, which can achieve the load balancing and maintain the packet sequences.

### 3.12 Memory Interface

Two kinds of external memory interface can be selected by user -- 1M byte memory (256K32 x 1) and 2 M bytes (256K32 x 2 or 512K32 x 1). Maximum 2M byte external memory can be used for packet buffering. "-10 " speed grade of SGRAM/SDRAM device is recommended. The following table is the

SGRAM application pin connection :

Memory Type	Memory Chip No	A[8]	CS0B	CS1B
256K32	x 1	A8	CS0B	NC
256K32	x 2	A8	CS0B	CS1B
512K32	x 1	A9	CS0B	A8

### 3.13 Internal MII Registers Access and Control

The MTD505 support 2 serial pins (SDIO/SDC) for internal registers access and control; The detailed registers informations are presented in Section4.0 (Internal MII Registers).

### 3.14 LED Display

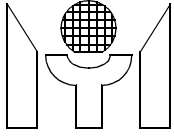
The MTD505 use 10 pins to output 2 kinds of LED display -- LEDDATA[7:0], LEDCLK1, LEDCLK2. Using LEDCLK1 rising edge, LEDDATA[7:0] report Port7~0 link/receive activity led status. Using LEDCLK2 rising edge, LEDDATA[4:0] report packet buffer utilization rating, and LEDDATA[7] report external memory test result(after power reset, MTD505 will test external SDRAM automatically), LEDDATA[6] report the buffer almost full alarm signal .

## 4.0 Internal MII Registers

The MTD505 implements 10 MII global registers and 4 per port registers, define as following tables:

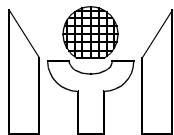
TABLE 1. MII registers

GLOBAL REGISTERS					
REG NO	Bits	Name	R/W	Descriptions	Default
0		CtlReg0	R/W	<b>CONTROL REGISTER 0</b>	
	8-0			bit[0] = 1 --> switch to port 0 registers bit[1] = 1 --> switch to port 1 registers bit[2] = 1 --> switch to port 2 registers bit[3] = 1 --> switch to port 3 registers bit[4] = 1 --> switch to port 4 registers bit[5] = reserved bit[6] = reserved bit[7] = reserved bit[8] = 1 --> switch to global registers	9'h100
	12-9			scan mode select 3-0	
	15-13			Scan port select	
1		CtlReg1	R/W	<b>CONTROL REGISTER 1</b>	16'h3084



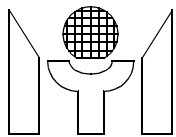
**TABLE 1. MII registers**

<b>GLOBAL REGISTERS</b>					
<b>REG NO</b>	<b>Bits</b>	<b>Name</b>	<b>R/W</b>	<b>Descriptions</b>	<b>Default</b>
	7-0	XON		XON threshold.	
	15-8	XOFF		XOFF threshold. While EEPROM is enabled, this register's content will be updated by EEPROM read XON/XOFF threshold data automatically. After EEPROM read is done, this register can be read/write by management cmd. default is 16'h3084(2M memory) or 16'h1838(1M memory)	
<b>2</b>		<b>CtlReg2</b>	<b>R/W</b>	<b>CONTROL REGISTER 2</b>	<b>16'd300</b>
	15-0	Aging		bit[15:0] can specify aging time. While EEPROM is enabled, this register's content will be updated by EEPROM read Aging timer data automatically. After EEPROM read is done, this register can be read/write by management cmd.	
<b>3</b>		<b>CtlReg3</b>	<b>R/W</b>	<b>CONTROL REGISTER 3</b>	<b>16'h000f</b>
	15-0	Uplink reg0		bit[15:12] specify port 3's uplink port ID. bit[11:8] specify port 2's uplink port ID. bit[7:4] specify port 1's uplink port ID. bit[3:0] specify port 0's uplink port ID. default is 16'h000f. P.S this register's write sequence is Jumper setting ==> EEPROM content ==> MII management command.	
<b>4</b>		<b>CtlReg4</b>	<b>R/W</b>	<b>CONTROL REGISTER 4</b>	<b>16'h0</b>
	15-0	Uplink reg1		bit[15:12] :reserved bit[11:8] : reserved bit[7:4] : reserved bit[3:0] specify port 4's uplink port ID. default is 16'h0. P.S this register's write sequence is Jumper setting ==> EEPROM content ==> MII management command.	
<b>5</b>		<b>CtlReg5</b>	<b>R/W</b>	<b>CONTROL REGISTER 5</b>	<b>16'hff</b>
	7-0			bit[7:0] specify broadcast threshold.	
	8			bit[8] enable enhance backpressure.	
	15-9			Reserved. P.S this register can be written by EEPROM content or MII management command too.	
<b>6</b>		<b>StsReg0</b>	<b>RO/RC</b>	<b>STATUS REGISTER 0</b>	
	7-0			bit[4:0] outputs port4-0 RXDMA fifofull, bit[7:5] : reserved.	



**TABLE 1. MII registers**

<b>GLOBAL REGISTERS</b>					
<b>REG NO</b>	<b>Bits</b>	<b>Name</b>	<b>R/W</b>	<b>Descriptions</b>	<b>Default</b>
	15-8			bit[12:8] outputs port4-0 TXDMA TPUR(fifoempty), bit[15:13] : reserved.	
<b>7</b>		<b>StsReg1</b>	<b>RO</b>	<b>STATUS REGISTER 1</b>	
				0 BufBistDone. 1 BufBistErr. 2 BufInitDone. 3 AddrTblBistDone. 4 AddrTblBistErr. 5 LthTblBistDone. 6 LthTblBistErr. 7 MemBistDone. 8 MemBistErr. 9 EEDone. 10 FreeCntls0. 15-11 Reserved.	
<b>8</b>		<b>CtlReg7</b>	<b>R/W</b>	<b>CONTROL REGISTER 7</b>	
	7-0			bit[4:0] output mii polling port4-0 flow control information, bit[7:5] : reserved	
	15-8			bit[12:8] output mii polling port4-0 link information, bit[15:13] : reserved. "1" means flow control enable or link good.	
<b>9</b>		<b>CtlReg8</b>	<b>R/W</b>	<b>CONTROL REGISTER 8</b>	
	7-0			bit[4:0] output mii polling port4-0 speed information, bit[7:5] : reserved.	
	15-8			bit[12:8] output mii polling port4-0 full information, bit[15:13] :reserved. "1" means 100M or full duplex.	
<b>PORT REGISTERS</b>					
<b>1</b>		<b>StsReg1</b>	<b>RO</b>	<b>STATUS REGISTER 1</b>	
	10-0			bit[10:0] output Port Tx queue head value.	
	15-11			Reserved.	
<b>2</b>		<b>StsReg2</b>	<b>RO</b>	<b>STATUS REGISTER 2</b>	
	10-0			bit[10:0] output Port Tx queue tail value.	
	15-11			Reserved.	
<b>3</b>		<b>StsReg3</b>	<b>RO</b>	<b>STATUS REGISTER 3</b>	
	10-0			bit[10:0] output Port Tx queue count value.	
	15-11			Reserved.	
<b>4</b>		<b>CtlReg1</b>	<b>R/W</b>	<b>CONTROL REGISTER 1</b>	
	7-0			bit[7:0] select Port VLAN group.	
	15-8			Reserved.	



"R/W" means read/writable.

## 5.0 Electrical Characteristics

### 5.1 Absolute Maximum Ratings

Symbol	Parameter	RATING	Unit
V <sub>CC</sub>	Power Supply Voltage	-0.3 to 3.6	V
V <sub>IN</sub>	Input Voltage	-0.3 to V <sub>CC</sub> +0.3	V
V <sub>OUT</sub>	Output Voltage	-0.3 to V <sub>CC</sub> +0.3	V
T <sub>STG</sub>	Storage Temperature	-55 to 150	°C

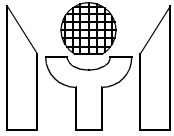
### 5.2 Recommended Operating Conditions

Symbol	Parameter	Min.	Typ.	Max.	Unit
V <sub>CC</sub>	Power Supply	3.0	3.3	3.6	V
V <sub>IN</sub>	Input Voltage	0	-	V <sub>CC</sub>	V
T <sub>j</sub>	Commercial Junction Operating Temperature	0	25	115	°C
	Industrial Junction Operating Temperature	-40	25	125	°C

### 5.3 DC Electrical Characteristics

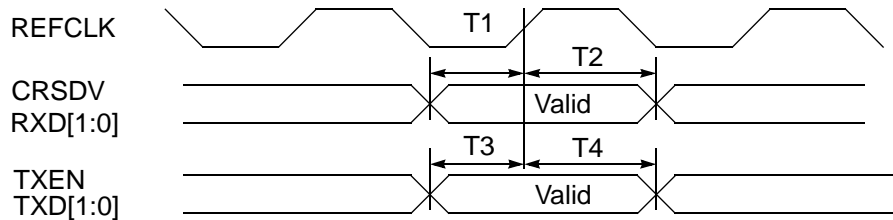
Symbol	Parameter	Conditions	Min.	Typ.	Max.	Unit
I <sub>IL</sub>	Input Leakage Current	no pull-up or down	-1		1	uA
I <sub>OZ</sub>	Tri-state Leakage Current		-1		1	uA
C <sub>IN</sub>	Input Capacitance			2.8		pF
C <sub>OUT</sub>	Output Capacitance		2.7		4.9	pF
C <sub>BID3</sub>	Bi-direction buffer Capacitance		2.7		4.9	pF
V <sub>IL</sub>	Input Low Voltage	CMOS			0.3*V <sub>CC</sub>	V
V <sub>IH</sub>	Input High Voltage	CMOS	0.7*V <sub>CC</sub>			V
V <sub>OH</sub>	Output High Voltage	I <sub>OL</sub> =2,4,8,12,16,24mA			0.4	V
V <sub>OL</sub>	Output Low Voltage	I <sub>OH</sub> =2,4,8,12,16,24mA	2.4			V
R <sub>I</sub>	Input Pull-up/down resistance	V <sub>IL</sub> =0V or V <sub>IH</sub> =V <sub>CC</sub>		75		KOhm

(Under recommended operating conditions and V<sub>CC</sub> = 3.0 ~ 3.6V, T<sub>j</sub> = 0 to +115 °C)



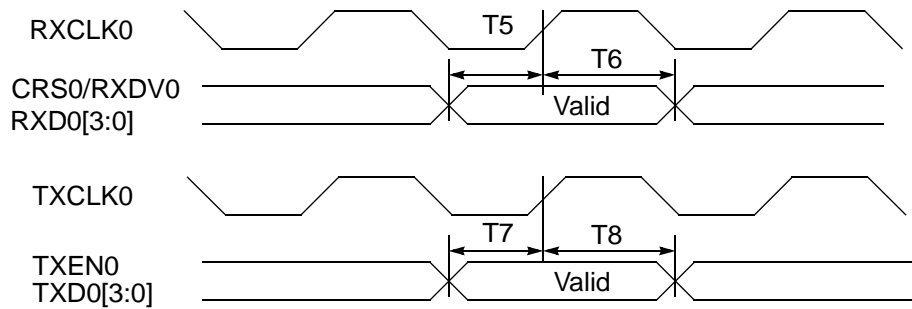
**5.4 Electrical Characteristics**

**FIGURE 1. RMII timing**



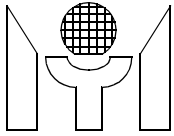
Symbol	Parameter	Min.	Typ.	Max.	Unit	Note
T1	RMII input setup time	1			nS	
T2	RMII input hold time	1			nS	
T3	RMII output setup time	3			nS	
T4	RMII output hold time	5			nS	

**FIGURE 2. MII timing**

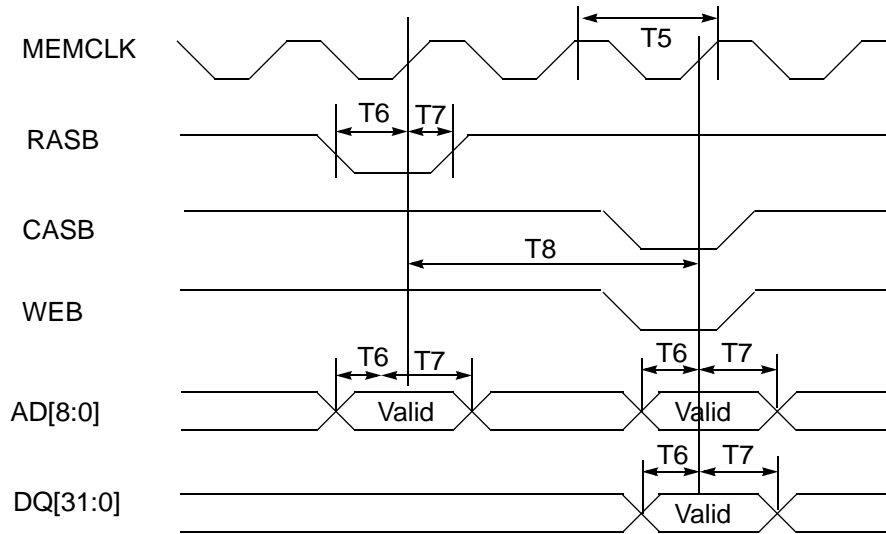


Symbol	Parameter	Min.	Typ.	Max.	Unit	Note
T5	MII input setup time	10			nS	
T6	MII input hold time	10			nS	
T7	MII output setup time	3			nS	
T8	MII output hold time	5			nS	



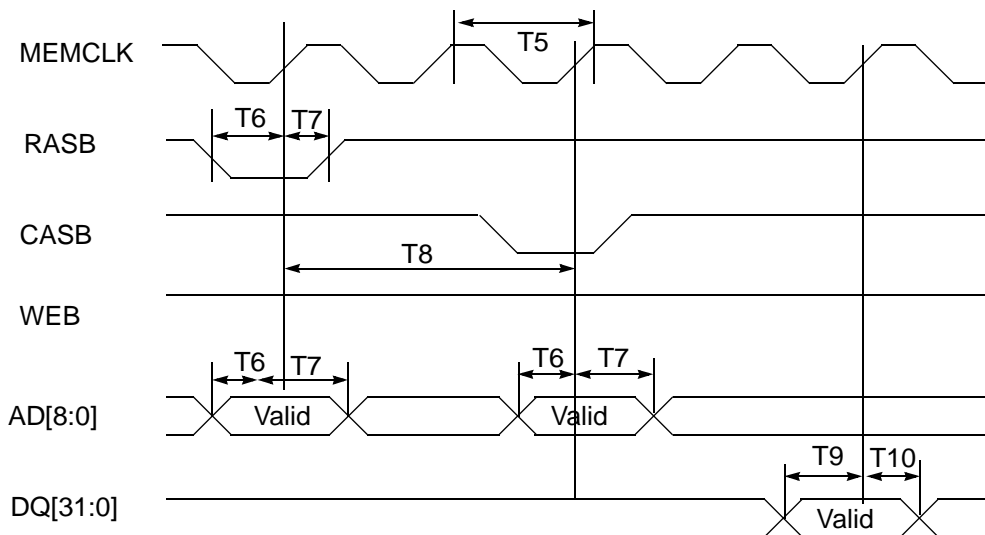


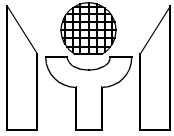
**FIGURE 3. Memory Write Timing**



Symbol	Parameter	Min.	Typ.	Max.	Unit	Note
T5	Memory clock cycle	12			nS	
T6	Memory command/address/data setup time	6			nS	
T7	Memory command/address/data hold time	2			nS	
T8	Row active to burst write		2		CLK	

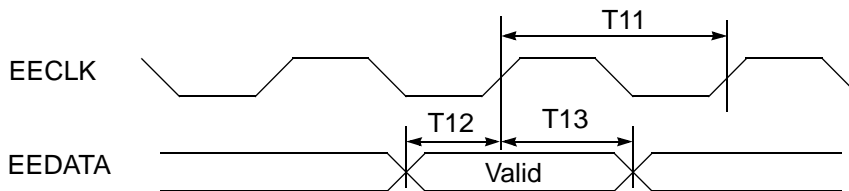
**FIGURE 4. Memory Read Timing**





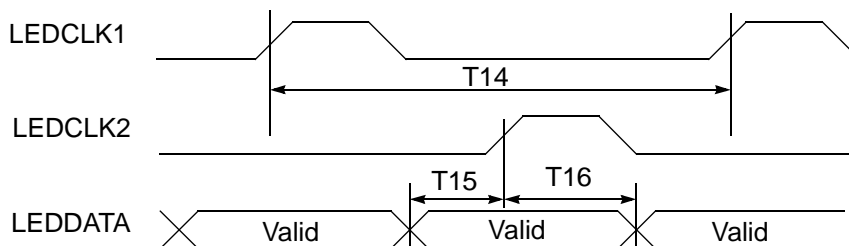
Symbol	Parameter	Min.	Typ.	Max.	Unit	Note
T10	Memory read data setup time	2			nS	
T11	Memory ead data hold time	2			nS	

**FIGURE 5. EEPROM timing**

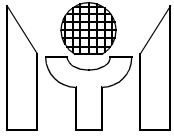


Symbol	Parameter	Min.	Typ.	Max.	Unit	Note
T11	EEPROM clock cycle		10		uS	
T12	EEDATA input setup time	1			nS	
T13	EEDATA input hold time	1			nS	

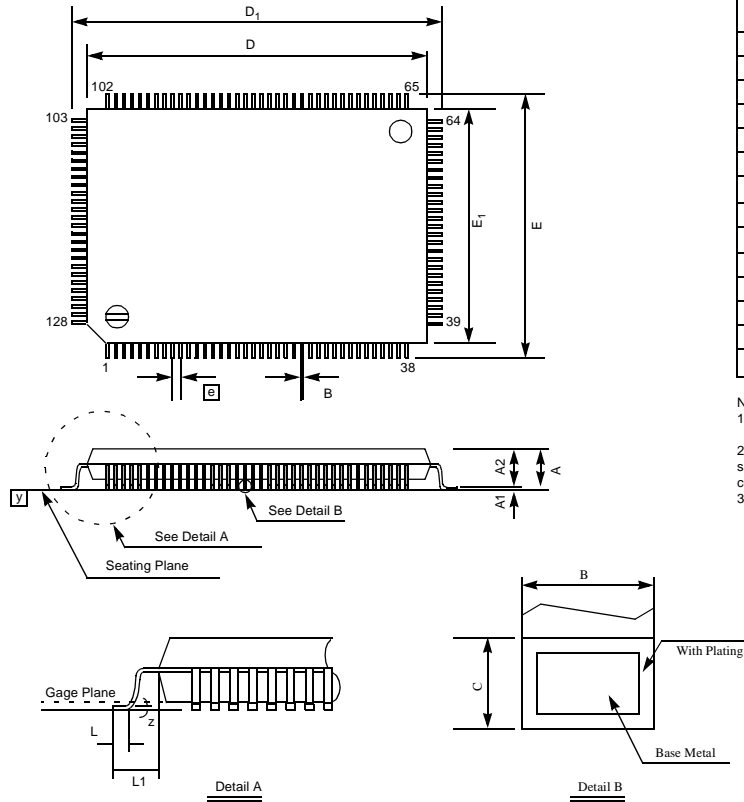
**FIGURE 6. LED Interface**



Symbol	Parameter	Min.	Typ.	Max.	Unit	Note
T14	Led display strobe period		20		uS	
T15	LEDCLK setup time		5		uS	
T16	LEDCLK hold time		5		uS	



**6.0 128 pin PQFP Package Data**



Symbol	Dimension in inch			Dimension in mm		
	Min	Norm	Max	Min	Norm	Max
A	-	-	0.134	-	-	3.40
A1	0.010	-	-	0.25	-	-
A2	0.107	0.112	0.117	2.73	2.85	2.97
B	0.007	0.009	0.011	0.17	0.22	0.27
C	0.004	-	0.008	0.09	-	0.20
D	0.906	0.913	0.921	23.00	23.20	23.40
$D_1$	0.783	0.787	0.791	19.90	20.00	20.10
E	0.669	0.677	0.685	17.00	17.20	17.40
$E_1$	0.547	0.551	0.555	13.90	14.00	14.10
$\square$	0.020 BSC			0.50 BSC		
L	0.029	0.035	0.041	0.73	0.88	1.03
L1	0.063 BSC			1.60 BSC		
y	-	-	0.004	-	-	0.10
z	0°	-	7°	0°	-	7°

Note:  
 1.Dimension  $D_1$  &  $E_1$  do not include mold protrusion. But mold mismatch is included. Allowable protrusion is .25mm/.010" per side.  
 2.Dimension B does not include dambar protrusion. Allowable dambar protrusion .08mm/.003". Total in excess of the B dimension at maximum material condition. Dambar cannot be located on the lower radius or the foot.  
 3.Controlling dimension : Millimeter.