

## Peak Emission Wavelength: 1300nm

The 1300nm IR emitter series is designed for applications requiring high output and precise optical / mechanical axis alignment. Custom package solutions and sorting are available.

### FEATURES

- > Metal Can Package
- > High Output Power
- > High Reliability

### APPLICATIONS

- > Optical Switches
- > Security Systems
- > Fiber Optical Communications

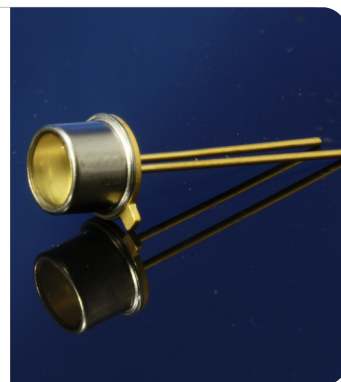

## Absolute Maximum Ratings (Ta=25°C)



ITEMS	SYMBOL	RATINGS	UNIT
Forward Current (DC)	IF	100	mA
Forward Current (Pulse)*1	IFP	1	A
Reverse Voltage	VR	5	V
Power Dissipation	PD	100	mW
Operating Temperature Range	Topr	-25 ~ +85	°C
Storage Temperature Range	Tstg	-30 ~ +100	°C
Junction Temperature	Tj	100	°C
Lead Soldering Temperature*2	Tls	260	°C

\*1: Tw=10μsec, T=10msec; \*2: Time 5 Sec max, Position: Up to 3mm from the body.

## Electrical & Optical Characteristics (Ta = 25°C)

ITEMS	SYMBOL	CONDITIONS	MIN	TYP	MAX	UNIT
Power Output	PO	IF=50mA	--	3.8	--	mW
Forward Voltage	VF	IF=50mA	--	0.8	1.1	V
Reverse Current	IR	VR=5V	--	--	100	μA
Peak Emission Wavelength	λp	IF=50mA	--	1300	--	nm
Spectral Line Half Width	Δλ	IF=50mA	--	85	--	nm
Half Intensity Beam Angle	Θ	IF=50mA	--	±25	--	deg

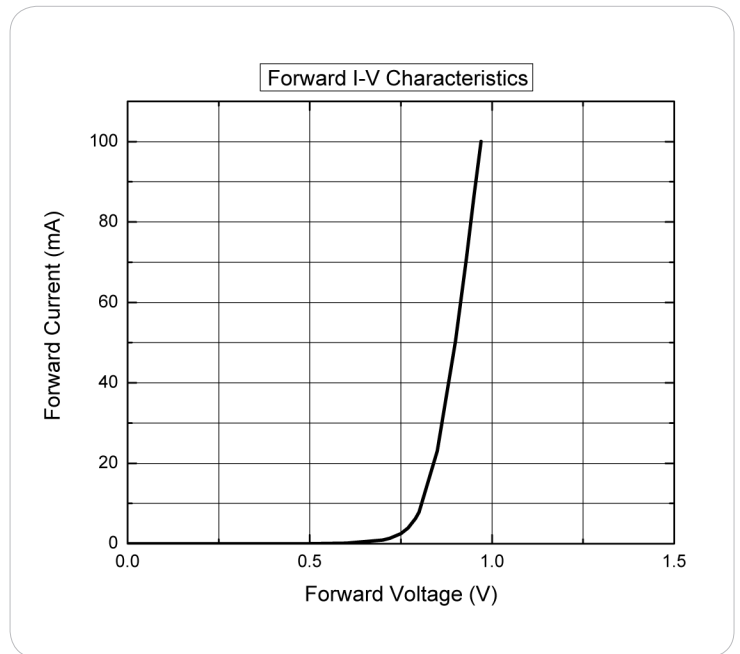
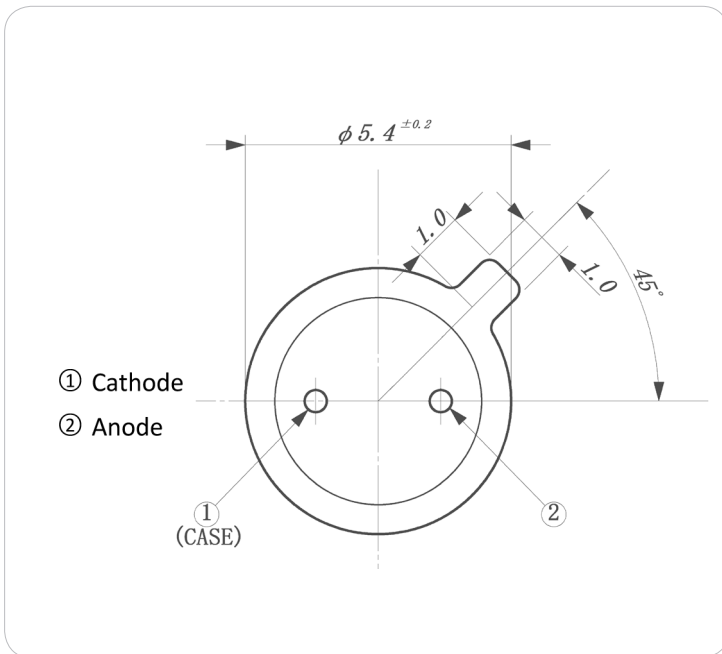
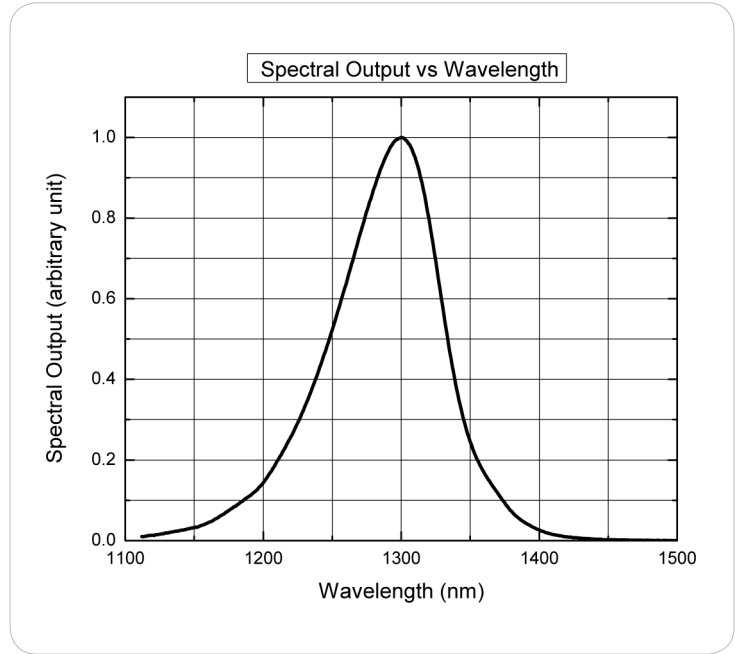
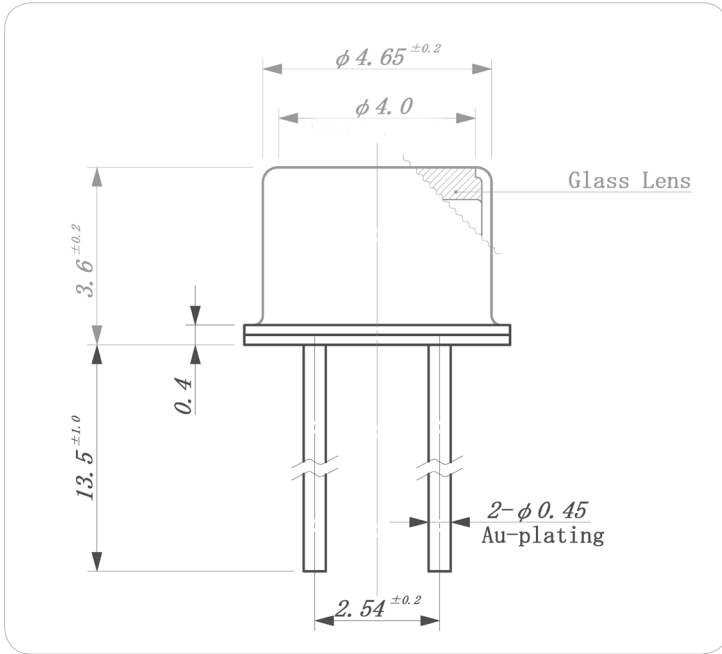

Unit: mm, Tolerance:  $\pm 0.2$

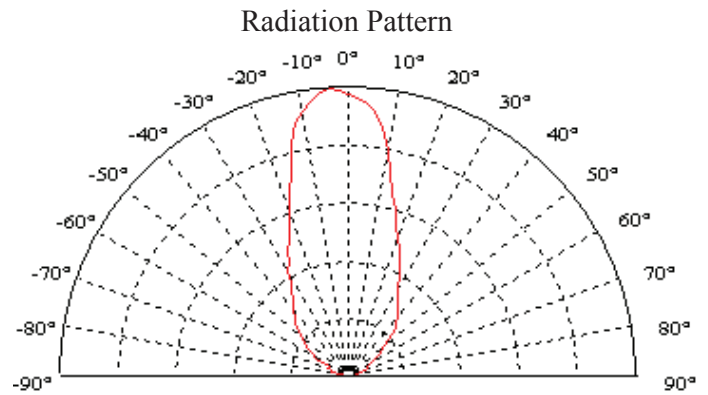
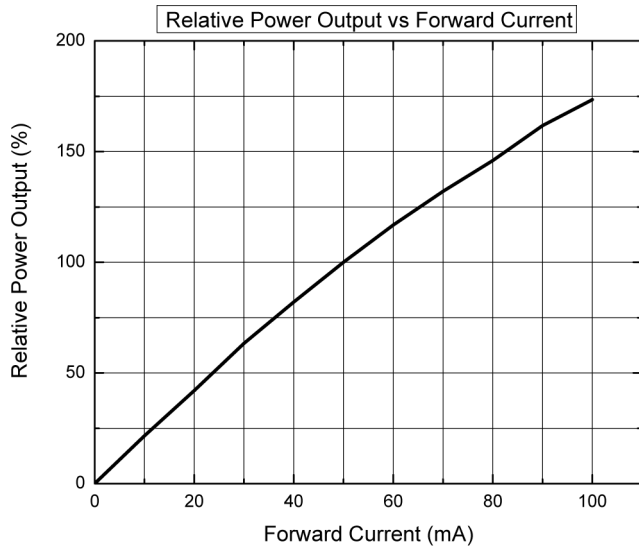

The information contained herein is subject to change without notice.

2013-3-12