

MTE8080PT

Features

High Output Power
Narrow Beam Angle
Compact
High Reliability in Demanding Environments

Applications

Optical Switches
Edge Sensing

Maximum Ratings (Ta=25°C)

Characteristic	Symbol	Max.	Test Condition	Unit
Forward Current	I _F	75	–	mA
Pulsed Forward Current	I _{FP}	.50	tw=10μS, T=10mS	A
Reverse Voltage	V _R	5	–	V
Power Dissipation	P _D	120.00	–	mW
Operating Temperature	T _{opr}	–20~+85	–	°C
Storage Temperature	T _{stg}	–30 ~+100	–	°C
Junction Temperature	T _j	100	–	°C
Soldering Temperature	T _{sol}	260	for 5 sec. max	°C

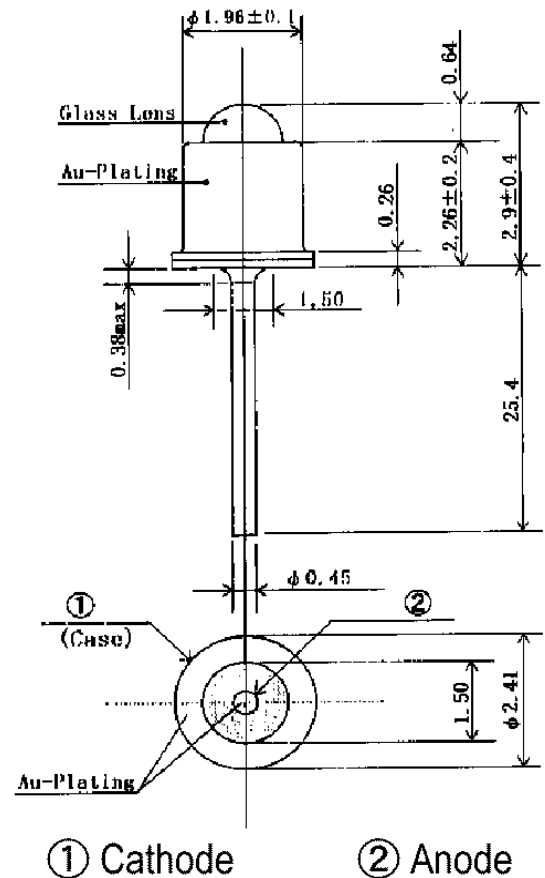

Opto-Electrical Characteristics (Ta=25°C)

Characteristic	Symbol	Test Condition	Min	Typ	Max	Unit
Forward Voltage	V _F	I _F =50mA	–	1.45	1.80	V
Reverse Current	I _R	V _R =5V	–	–	10	μA
Power Output	PO	I _F =50mA	–	2.50	–	mW
Half Intensity Beam Angle	θ	–	–	± 4°	–	deg.
Peak Wavelength	λ _p	I _F =50mA	–	880	–	nm
Spectral Line Half Width	Δλ	I _F =50mA	–	60	–	nm
Rise Time	T _r	I _{FP} =50mA	–	1.50	–	ns
Fall Time	T _f	I _{FP} =50mA	–	.80	–	ns
Temp Coefficient of PO	P/T	I _F =10mA	–	–.50	–	%/°C
Temp Coefficient of VF	V/T	I _F =10mA	–	–1.50	–	mV/°C
Junction Capacitance	C _j	1 MHz, V=0V	–	15	–	pF

Company Headquarters
120 Broadway
Menands, New York 12204
Toll Free: 800.984.5337
Fax: 518.432.7454

MTE8080PT Graphs

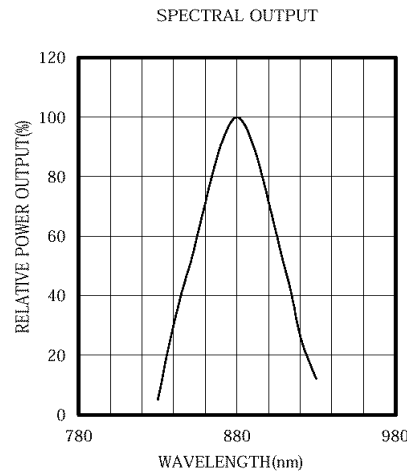
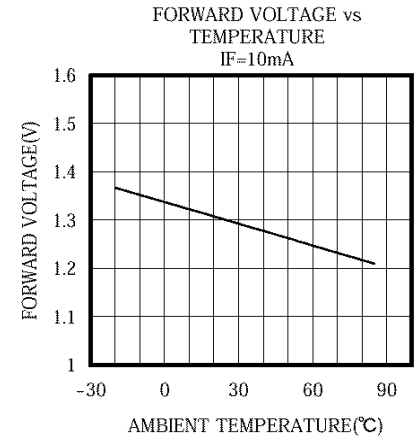
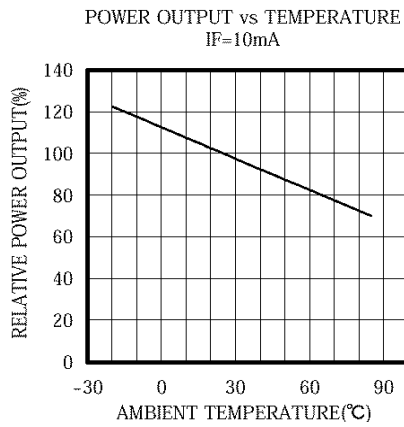
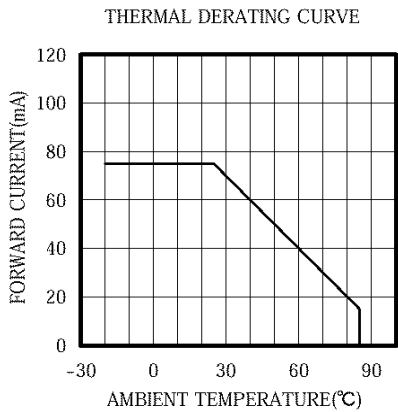
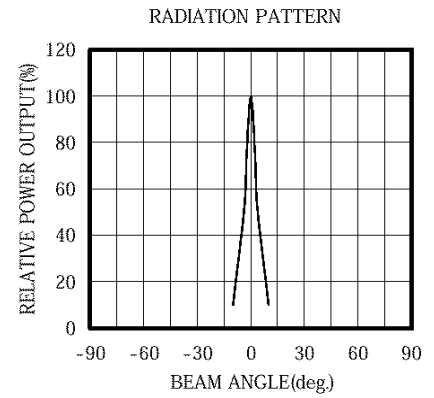
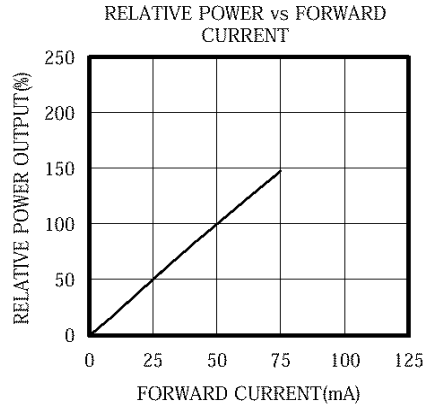
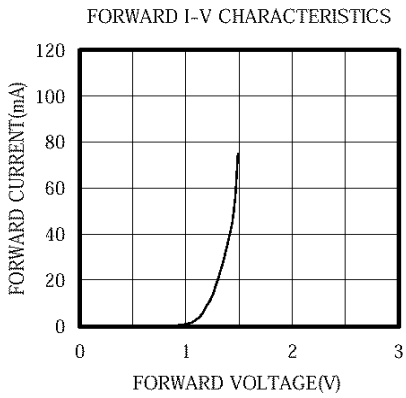

Company Headquarters
 120 Broadway
 Menands, New York 12204
 Toll Free: 800.984.5337
 Fax: 518.432.7454

West Coast Sales Office
 950 South Coast Drive, Suite 265
 Costa Mesa, California 92626
 Toll Free: 800.984.5337
 Fax: 714.850.9314