

MTE9094N

Features

High Output Power
Narrow Beam Angle
High Reliability

Applications

Optical Switches
Bar-Code Reader

Maximum Ratings (Ta=25°C)

| Characteristic | Symbol | Max. | Test Condition | Unit |
|------------------------|------------------|--------------|--------------------|------|
| Forward Current | I _F | 100 | – | mA |
| Pulsed Forward Current | I _{FP} | 1.00 | tw=10μs, T=10ms | A |
| Reverse Voltage | V _R | 5 | – | V |
| Power Dissipation | P _D | 180.00 | – | mW |
| Operating Temperature | T _{opr} | -20 ~ +80 | – | °C |
| Storage Temperature | T _{stg} | -30 ~+100 | – | °C |
| Junction Temperature | T _j | 100 | – | °C |
| Soldering Temperature | T _{sol} | 260 | for 5 sec. max | °C |

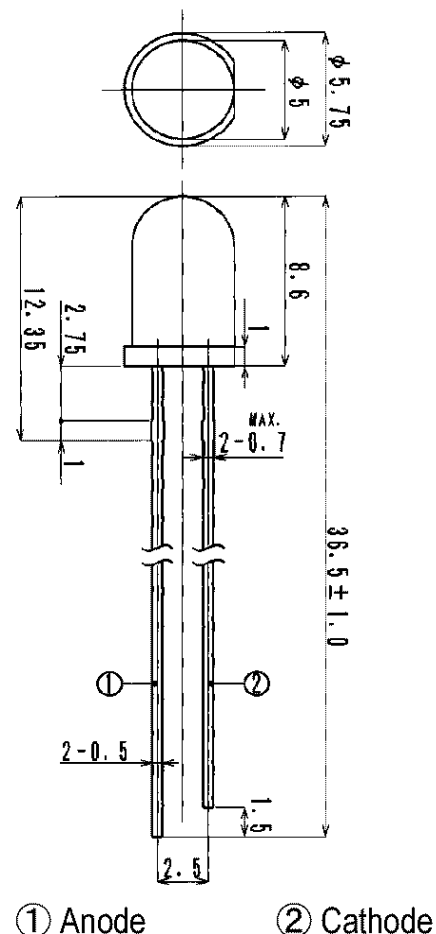

Opto-Electrical Characteristics (Ta=25°C)

| Characteristic | Symbol | Test Condition | Min | Typ | Max | Unit |
|------------------------------------|----------------|-----------------------|-----|-------|------|-------|
| Forward Voltage | V _F | I _F =50mA | – | 1.35 | 1.70 | V |
| Reverse Current | I _R | V _R =5V | – | – | 10 | μA |
| Power Output | PO | I _F =50mA | – | 10.00 | – | mW |
| Half Intensity Beam Angle | θ | – | – | ± 12° | – | deg. |
| Peak Wavelength | λ _p | I _F =50mA | – | 945 | – | nm |
| Spectral Line Half Width | Δλ | I _F =50mA | – | 50 | – | nm |
| Rise Time | T _r | I _{FP} =50mA | – | 1.00 | – | ns |
| Fall Time | T _f | I _{FP} =50mA | – | 1.00 | – | ns |
| Temp Coefficient of PO | P/T | I _F =10mA | – | –.50 | – | %/°C |
| Temp Coefficient of V _F | V/T | I _F =10mA | – | –1.30 | – | mV/°C |
| Junction Capacitance | C _j | 1 MHz, V=0V | – | 20 | – | pF |

Company Headquarters
120 Broadway
Menands, New York 12204
Toll Free: 800.984.5337
Fax: 518.432.7454

MTE9094N Graphs

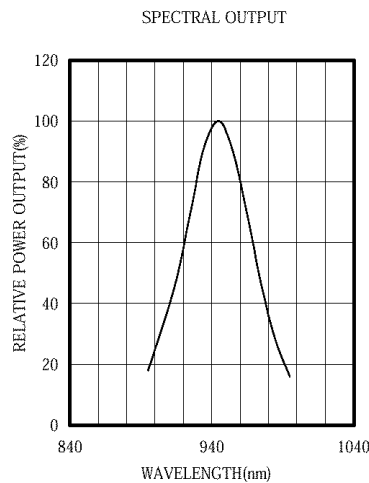
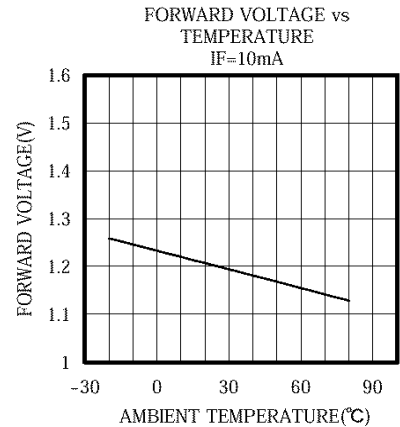
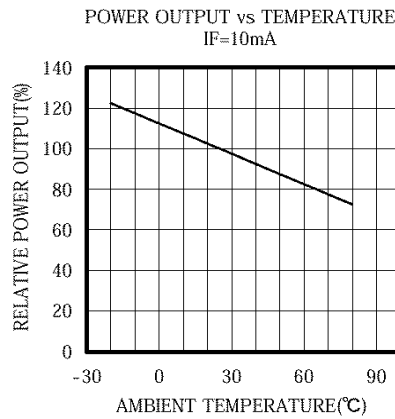
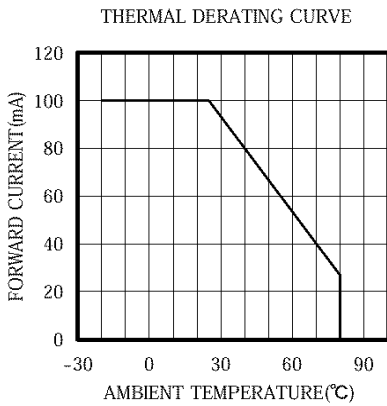
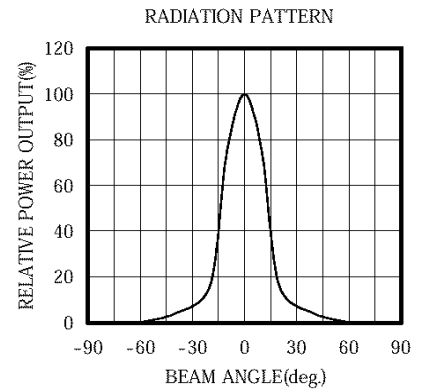
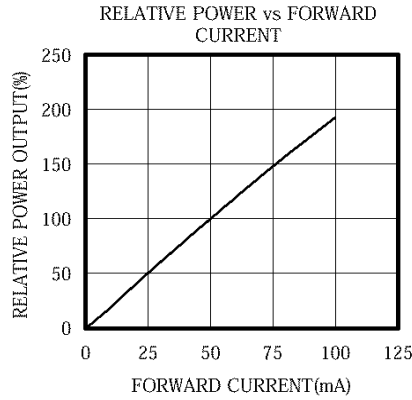
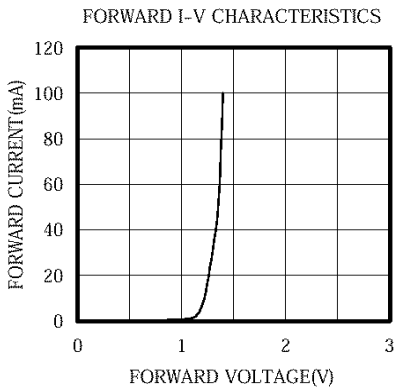

Company Headquarters
 120 Broadway
 Menands, New York 12204
 Toll Free: 800.984.5337
 Fax: 518.432.7454

West Coast Sales Office
 950 South Coast Drive, Suite 265
 Costa Mesa, California 92626
 Toll Free: 800.984.5337
 Fax: 714.850.9314