





Messrs.					
Product Specification	Model:	MTF-TQ24NN731-LB	Rev. No.	Issued Date.	Page.
			B	Nov.26, 07	1 / 28

**LIQUID CRYSTAL DISPLAY MODULE**  
**MODEL: MTF-TQ24NN731-LB**  
**Customer's No.:**

Acceptance

*Microtips Technology Inc.*  
 12F. No.31 Lane 169, Kang Ning St.,  
 His-Chih, Taipei Hsien, Taiwan  
 FAX: 886-2-26958625

Approved and Checked by

Approved by	Checked by		Made by
			



*Microtips Technology Inc.*



Messrs.					
Product Specification	Model:	MTF-TQ24NN731-LB	Rev. No.	Issued Date.	Page.
			B	Nov.26, 07	3 / 28

## Contents

<b>1. GENERAL DESCRIPTION AND FEATURES.....</b>	<b>5</b>
1.1 Features .....	5
1.2 General Specifications.....	5
<b>2. INTERFACE PINS ASSIGNMENT.....</b>	<b>6</b>
<b>3. OPTICAL CHARACTERISTICS.....</b>	<b>7</b>
<b>4. ABSOLUTE MAXIMUM RATINGS.....</b>	<b>10</b>
4.1 TFT-LCD Panel Absolute Maximum Ratings.....	10
4.2 Back-Light Unit.....	10
4.3 Environmental Condition .....	10
<b>5. INTERFACE SPECIFICATIONS.....</b>	<b>11</b>
5.1 DC Characteristic .....	11
<b>6. ELECTRICAL CHARACTERISTICS.....</b>	<b>12</b>
6.1 TFT-LCD module.....	12
6.2 Back-Light Unit.....	12
<b>7. Block Diagram .....</b>	<b>13</b>
7.1 TFT-LCD Block Diagram.....	13
7.2 Back-light Unit.....	13
7.3 DC Electrical Characteristics .....	14
7.4 Reset Timing Characteristics .....	15
7.5 LCD Driver Output Characteristics .....	15
7.6 AC Characteristics .....	16
<b>8. COMMAND LIST &amp; INSTRUCTION DESCRIPTIONS.....</b>	<b>17</b>
<b>9. QUALITY STANDARD FOR LCD .....</b>	<b>17</b>
9.1 Objective.....	17
9.2 Scope .....	17
9.3 Inspection specification.....	19
<b>10. RELIABILITY CONDITION FOR LCD .....</b>	<b>22</b>
10.1 LCM Reliability Test .....	22
<b>11. PRECAUTIONS .....</b>	<b>24</b>



Messrs.					
Product Specification	Model:	MTF-TQ24NN731-LB	Rev. No.	Issued Date.	Page.
			<i>B</i>	<i>Nov.26, 07</i>	<i>4 / 28</i>

11.1 Operation..... 24

11.2 Safety..... 24

11.3 Handling ..... 24

11.4 Static electricity..... 26

11.5 Storage..... 26

11.6 Cleaning..... 26

11.7 Waste..... 26

**12.WARRANTY** ..... 27

**13.DIMENSIONAL OUTLINES**..... 27



Messrs.					
Product Specification	Model:	MTF-TQ24NN731-LB	Rev. No.	Issued Date.	Page.
			B	Nov.26, 07	5 / 28

## 1. GENERAL DESCRIPTION AND FEATURES

MTF-TQ24NN731-LB is a TM (Transmissive) type color active matrix TFT (Thin Film Transistor) liquid crystal display (LCD) that uses amorphous silicon TFT as a switching device. This model is composed of a TN TFT-LCD module, a driver circuit and a back-light unit. The resolution of a 2.4" contains 240RGB×320 dots and can display 262K colors. The following table described the features of MTF-TQ24NN731-LB.

### 1.1 Features

- Transmissive type with LED back-light.
- TN (Twisted Nematic) mode.
- 18-bit CPU interface with Intel 80 series
- ILI9325 TFT driver IC installed

### 1.2 General Specifications

Item	Specification	Unit
Screen Size	2.4 inches diagonal	--
Display Resolution	240 x RGB x 320	Dot
Pixel Pitch	0.153(H) × 0.153(V)	mm
Active Area	36.72(H) × 48.96(V)	mm
Outline Dimension	42.72(W) × 60.26(H) × 3.0(D), without FPCB tail	mm
Weight	14.5	g
Display Mode	Normally white/Transmissive/Wide view	--
Pixel Arrangement	RGB-Stripe	--
Display Color	262K	--
Viewing Direction	12 o'clock	--
Input Interface	18-bit high-speed bus interface (Intel 80 series)	--
Color Garmut	NTSC 60 %	--



Messrs.					
Product Specification	Model:	MTF-TQ24NN731-LB	Rev. No.	Issued Date.	Page.
			B	Nov.26, 07	6 / 28

## 2. INTERFACE PINS ASSIGNMENT

Pin No.	Symbol	Function
1	LED_A	Power supply for White LED(+)
2	LED_K1	Power supply for White LED(-)
3	LED_K2	Power supply for White LED(-)
4	LED_K3	Power supply for White LED(-)
5	LED_K4	Power supply for White LED(-)
6	NC	No connector
7	NC	No connector
8	NC	No connector
9	NC	No connector
10	NC	No connector
11	VDD	Power supply for logic voltage
12	GND	Power ground
13	nRESET	Reset Signal Input Pin
14	DB17	Data input bus
15	DB16	Data input bus
16	DB15	Data input bus
17	DB14	Data input bus
18	DB13	Data input bus
19	DB12	Data input bus
20	DB11	Data input bus
21	DB10	Data input bus
22	DB9	Data input bus
23	DB8	Data input bus
24	DB7	Data input bus
25	DB6	Data input bus
26	DB5	Data input bus
27	DB4	Data input bus
28	DB3	Data input bus
29	DB2	Data input bus
30	DB1	Data input bus
31	DB0	Data input bus
32	nRD	Read execution control Pin
33	nWR	Write execution control Pin
34	RS	Data/Instruction select Input Pin
35	nCS	Chip Select Input Pin
36	GND	Power ground
37	GND	Power ground
38	VCI	Power supply for analog voltage
39	VDD	Power supply for logic voltage



Messrs.					
Product Specification	Model:	MTF-TQ24NN731-LB	Rev. No.	Issued Date.	Page.
			B	Nov.26, 07	7 / 28

### 3. OPTICAL CHARACTERISTICS

The following items are measured under stable conditions. The optical characteristics should be measured in a dark room or equivalent state with the methods shown in Note (1).

Measuring equipment: LCD-5000, BM-5A, BM-7, PR-650, EZ-Contrast

(Ta=25±2°C, Vcc=V<sub>CI</sub>=2.8V, I<sub>F</sub>=80mA)

Item		Symbol	Condition	Min	Type	Max	Unit	Note	
Brightness		Br	θ=0° Normal viewing angle At the center of panel Backlight On Equipment: BM7 Field=1°	200	250	-	cd/m <sup>2</sup>	Note 1	
Response time		T <sub>r</sub>		-	30	40	ms	Note 2	
		T <sub>f</sub>							
Contrast ratio		CR			150	250	-	-	Note 3
Color Chromaticity	Red	R <sub>x</sub>			0.57	0.62	0.67	-	-
		R <sub>y</sub>			0.30	0.35	0.40	-	
	Green	G <sub>x</sub>			0.25	0.30	0.35	-	
		G <sub>y</sub>			0.57	0.62	0.67	-	
	Blue	B <sub>x</sub>			0.09	0.14	0.19	-	
		B <sub>y</sub>			0.05	0.10	0.15	-	
	White	W <sub>x</sub>		0.25	0.30	0.35	-		
		W <sub>y</sub>		0.28	0.33	0.38	-		
Viewing Angle (12H)	Left	θ <sub>L</sub>	CR ≥ 10 Backlight On Equipment: BM7 Field=1°	-	60	-	Degree	Note 4	
	Right	θ <sub>R</sub>		-	60	-			
	Top	θ <sub>B</sub>		-	60	-			
	Bottom	θ <sub>F</sub>		-	40	-			
Uniformity		Un	θ=0° Normal viewing angle Backlight On Equipment: BM7 Field=1°	70	80	-	%	Note 5	

**Note 1 : Test Equipment Setup**

After stabilizing and leaving the panel alone at a given temperature for 30 min., the measurement should be executed. Measurement should be executed in a stable, windless, and dark room, 30 min. after turning the back light on. This should be measured in the center of screen.

Back-Light current: 20 mA

Environment condition: 1. Ta=25±2°C

2. Illuminations ≤ 1 lux



*Microtips Technology Inc.*

Messrs.					
Product Specification	Model:	MTF-TQ24NN731-LB	Rev. No.	Issued Date.	Page.
			B	Nov.26, 07	8 / 28

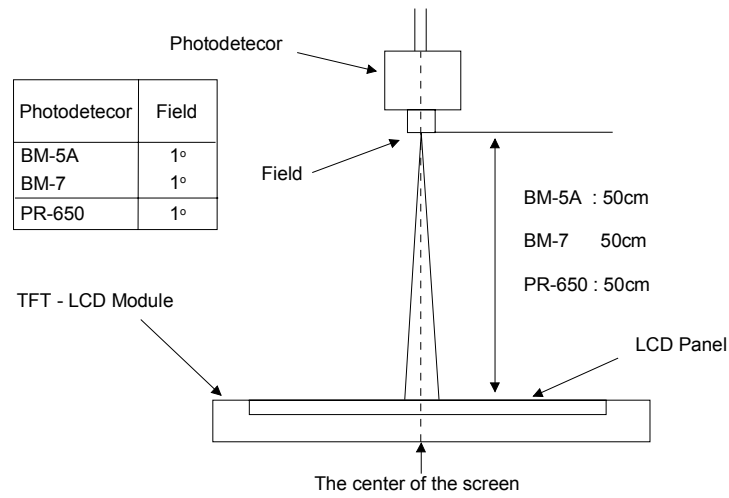

Note 2 : Definition of response time: Tr and Tf

The response time is defined as the following figure and shall be measured by switching the input signal for "black" and "white".

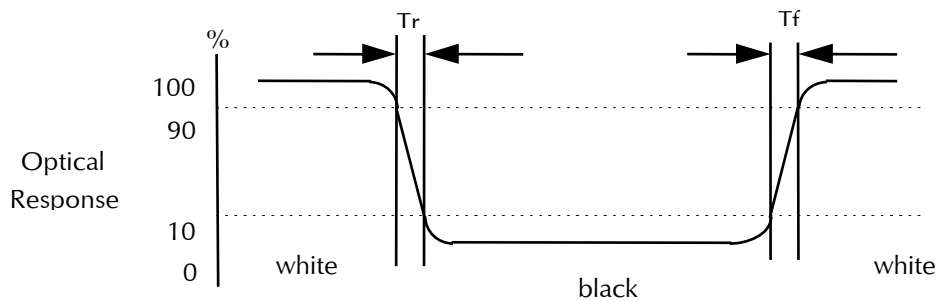

Note 3 : Definition of contrast ratio:

$$\text{Contrast Ratio (CR)} = \frac{\text{Brightness measured when LCD is at "white state"}}{\text{Brightness measured when LCD is at "black state"}}$$



*Microtips Technology Inc.*



Messrs.					
Product Specification	Model:	MTF-TQ24NN731-LB	Rev. No.	Issued Date.	Page.
			B	Nov.26, 07	9 / 28

Note 4 : Measured at the center area of the panel when all the input terminals of LCD panel are electrically opened.

### View Angle

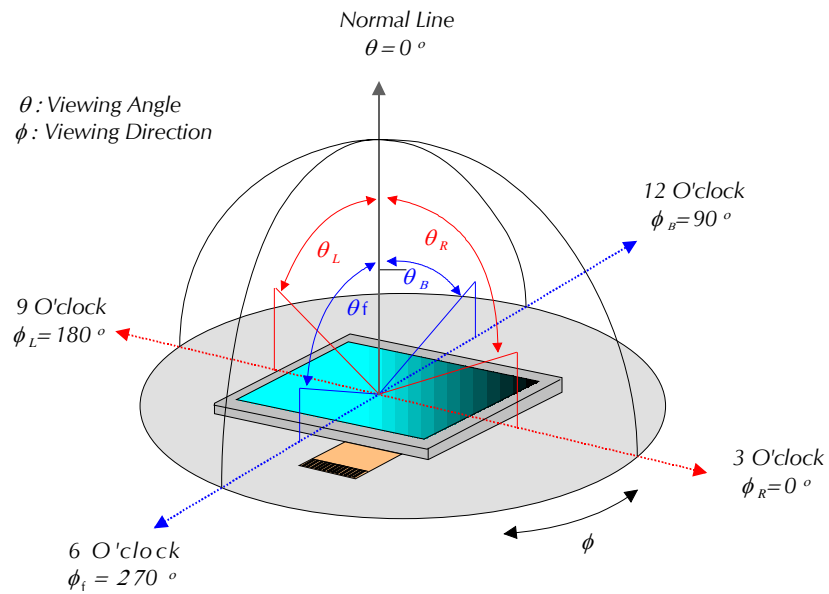

Note 5 : This is the reference value. The white-LED life time is defined as a time when brightness not to become under 50% of the original value (at  $T_a=25^\circ\text{C}$ )



**Microtips Technology Inc.**

Messrs.					
Product Specification	Model:	MTF-TQ24NN731-LB	Rev. No.	Issued Date.	Page.
			B	Nov.26, 07	10 / 28

#### 4. ABSOLUTE MAXIMUM RATINGS

##### 4.1 TFT-LCD Panel Absolute Maximum Ratings

Ta=25°C GND=0V

Parameter	Symbol	Condition	Rating		Unit	Notw
			Min	Max		
Input Power supply voltage	V <sub>CC</sub>	GND=0V	-0.3	4.6	V	--
	V <sub>ci</sub>	GND=0V	-0.3	4.6	V	--
	V <sub>in</sub>	GND=0V	-0.3	V <sub>CC</sub> +0.3	V	--

Note: If the LSI is used above these absolute maximum ratings. It may become permanently damaged. Using the LSI within the following electrical characteristics limit is strongly recommended for normal operation. If these electrical characteristic conditions are also exceeded, the LSI will malfunction and cause poor reliability.

##### 4.2 Back-Light Unit

Ta = 25°C

Item	Symbol	Min.	Max..	Unit	Remark
Current	I <sub>F</sub>	--	25	mA	--

For each LED

##### 4.3 Environmental Condition

Parameter	Symbol	Min	Max	Remark
Storage Temperature	T <sub>ST</sub>	-30°C	+80°C	Non-condensation
Operating Temperature	T <sub>OP</sub>	-20°C	+70°C	

Note:

Corrosive gas environment is not acceptable.

TFT\_LCD color will change slightly depending on environment temperature. This phenomenon is reversible.

Current reduction rate of LED backlight is according to the graph indicated below:

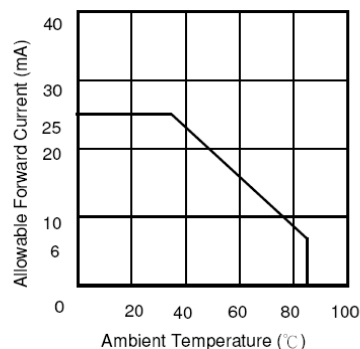

**Microtips Technology Inc.**

Messrs.					
Product Specification	Model:	MTF-TQ24NN731-LB	Rev. No.	Issued Date.	Page.
			B	Nov.26, 07	11 / 28

## 5. INTERFACE SPECIFICATIONS

### 5.1 DC Characteristic

(Ta=25°C, V<sub>CC</sub>=2.4~3.3V V<sub>ci</sub>=2.5~3.3V)

Parameter	Symbol	Min.	Typ.	Max.	Unit	Note
Power Supply Voltage (1)	VCC, IOVCC	-0.3	-	4.6	V	1,2
Power Supply Voltage (1)	VCI~AGND	-0.3	-	4.6	V	1,4
Power Supply Voltage (1)	DDVDH~AGND	-0.3	-	6.0	V	1,4
Power Supply Voltage (1)	AGND~VCL	-0.3	-	4.6	V	1
Power Supply Voltage (1)	DDVDH~VCL	-0.3	-	9.0	V	1,5
Power Supply Voltage (1)	VGH~AGND	-0.3	-	+18.5	V	1,5
Power Supply Voltage (1)	AGND~VGL	-0.3	-	+18.5	V	1,6
Input Voltage	Vi	-0.3	-	VCC+0.3	V	1

Note : (1) VCC, DGND must be maintained

(2) (High) (VCC=VCC)  $\geq$  DGND (Low). (High) IOVCC  $\geq$  DGND (Low).

(3) Make sure (High) VCL  $\geq$  DGND (Low)

(4) Make sure (High) DDVDH  $\geq$  ASSD (Low)

(5) Make sure (High) DDVDH  $\geq$  VCL (Low)

(6) Make sure (High) VGH  $\geq$  ASSD (Low)



Messrs.					
Product Specification	Model:	MTF-TQ24NN731-LB	Rev. No.	Issued Date.	Page.
			B	Nov.26, 07	12 / 28

## 6. ELECTRICAL CHARACTERISTICS

### 6.1 TFT-LCD module

(Ta=25°C)

Characteristics		Symbol	MIN.	TYP.	MAX.	Unit	Note
Supply Voltage		IOVCC	1.65	2.8	3.3	V	-
		Vci	2.5	2.8	3.3	V	-
Supply Current (V <sub>DD</sub> =2.8V)	Stand-by	I <sub>F</sub>	-	0.4	-	mA	-
	8-color		-	4.5	-		
	Picture		-	5.4	-		
	Full on		-	5.9	-		
Supply Current (V <sub>DD</sub> =3.3V)	Stand-by	I <sub>F</sub>	-	0.4	-	mA	-
	8-color		-	6.4	-		
	Picture		-	6.3	-		
	Full on		-	6.8	-		

### 6.2 Back-Light Unit

Characteristics	Symbol	MIN.	TYP.	MAX.	Unit	Note
Current	IF	-	80	-	mA	
LED Power	Vf	(3.2)	(3.4)	(3.5)	V	

\* The current of LED is 20mA for each one.  
LED driving in constant current mode is recommended.



*Microtips Technology Inc.*

Messrs.					
Product Specification	Model:	MTF-TQ24NN731-LB	Rev. No.	Issued Date.	Page.
			B	Nov.26, 07	13 / 28

## 7. Block Diagram

### 7.1 TFT-LCD Block Diagram

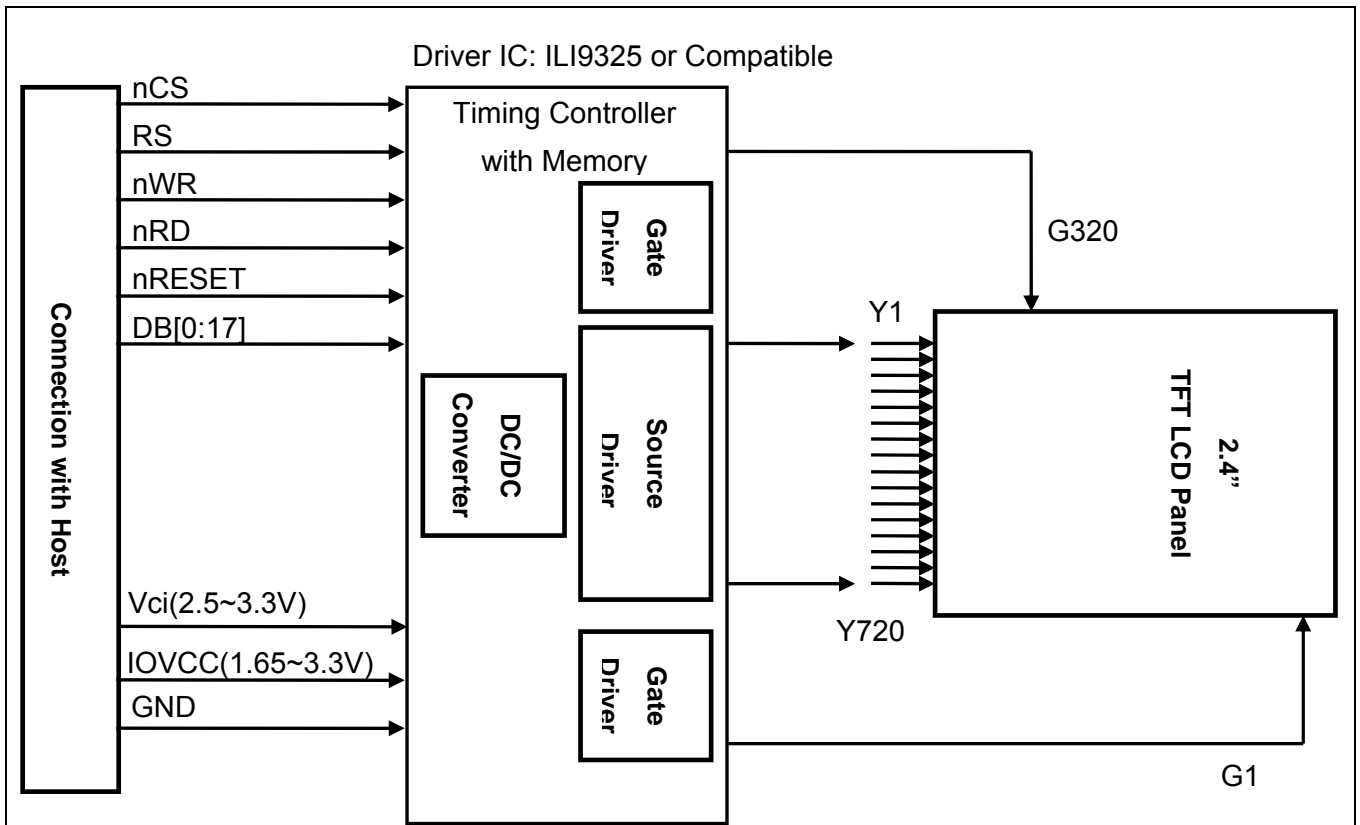

### 7.2 Back-light Unit

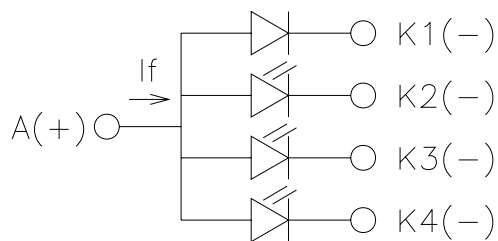

Messrs.					
Product Specification	Model:	MTF-TQ24NN731-LB	Rev. No.	Issued Date.	Page.
			B	Nov.26, 07	14 / 28

### 7.3 DC Electrical Characteristics

(TA =25°C, V<sub>CC</sub> =2.4~3.3V, IOV<sub>CC</sub>=1.65~3.3V, V<sub>SS</sub>=0V)

Item	Symbol	Unit	Test Condition	Min.	Typ.	Max.
Input high voltage	VIH	V	VCC=1.8~3.3V	0.8xI <sub>OVCC</sub>	-	I <sub>OVCC</sub>
Input low voltage	VIL	V	VCC=1.8~3.3V	-0.3V	-	0.2xI <sub>OVCC</sub>
Output high voltage(1) (DB0-170 Pins)	VOH1	V	IOH = -0.1mA	0.8xI <sub>OVCC</sub>	-	-
Output low voltage (DB0-170 Pins)	VOL1	V	I <sub>OVCC</sub> = 1.65 ~ 3.3V, VCC=2.4~3.3V I <sub>OL</sub> = 0.1mA	-	-	0.2xI <sub>OVCC</sub>
I/O leakage current	ILi	μA	Vin = 0 ~ VCC	-0.1	-	0.1
Current consumption during normal operation (VCC - DGND)	I <sub>OPt</sub>	μA	VCC=2.8V, Ta=25°C fOSC=376KHz (Line) GRAM=0000h	-	100 (VCC)	-
Current consumption during standby mode (VCC - DGND)	I <sub>STi</sub>	μA	VCC=2.8V, Ta=25°C	-	5	10
LCD Drive power supply current (DDVDH-DGND)	I <sub>LCD</sub>	mA	VCC=2.8V, VRE1OUT=4.8V DDVDH=5.0V, fOSC=376KHz (320 line), Ta=25°C, GRAM data=0000h, REV="0", SAP="001", ON4-0="0" OP4-0="0", MP52-00="0" MN52-00="0", CP12- 00="0" CN12-00="0"	-	3.0	-
LCD Driving Voltage (DDVDH-DGND)	DDVDH	V	-	4.5	-	6
Output Voltage deviation	-	mV	-	-	5	-
Dispersion of the Average Output Voltage	V	mV	-	-10	-	10



Messrs.					
Product Specification	Model:	MTF-TQ24NN731-LB	Rev. No.	Issued Date.	Page.
			B	Nov.26, 07	15 / 28

#### 7.4 Reset Timing Characteristics

Item	Symbol	Unit	Min.	Typ.	Max.
Reset low-level width	$t_{RES}$	ms	1	-	-
Reset rise time	$t_{RRES}$	$\mu S$	-	-	10

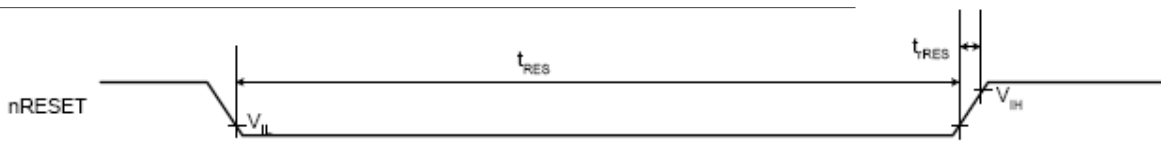

#### 7.5 LCD Driver Output Characteristics

Item	Symbol	Timing diagram	Min.	Typ.	Max.	Unit
Driver output delay time	$t_{DD}$	VCC=28V,DDVDH=5.0V,VREG10UT=4.8V, RC oscillation: fosc=376KHz (320 lines). Ta = 25°C REV=0, SAP=010, AP=010, ON14-00=0, OP14-00=0, MP52-00=0, MN52-00=0, CP12-00=0, CN12-00=0, Load resistance R=10 K $\Omega$ , Load capacitance C=20pF. When the level change from a same grayscale level on all pins. Time to reach +/-35mV when VCOM polarity inverts	-	35	-	$\mu S$



Messrs.					
Product Specification	Model:	MTF-TQ24NN731-LB	Rev. No.	Issued Date.	Page.
			B	Nov.26, 07	16 / 28

7.6 AC Characteristics

i80-System Interface Timing Characteristics

(IOVCC = 1.65~3.3V, VCC = 2.4~3.3V)

Parameter		Symbol	Min.	Typ.	Max.	Condition	Units
Bus Cycle Time	Write	$t_{CYCW}$	100	-	-	-	ns
	Read	$t_{CYCR}$	300	-	-	-	ns
Write low-level pulse width		$PW_{LW}$	50	-	500	-	ns
Write high-level pulse width		$PW_{HW}$	50	-	-	-	ns
Read low-level pulse width		$PW_{LR}$	150	-	-	-	ns
Read high-level pulse width		$PW_{HR}$	150	-	-	-	ns
Write / Read rise / fall time		$t_{WRr}/t_{WRf}$	-	-	25	-	ns
Setup Time	Write ( RS to nCS, E/nWR)	$t_{AS}$	10	-	-	-	ns
	Read ( RS to nCS, RE/nRD)		5	-	-	-	ns
Address hold time		$t_{AH}$	5	-	-	-	ns
Write data set up time		$t_{DSW}$	10	-	-	-	ns
Write data hold time		$t_H$	15	-	-	-	ns
Read data delay time		$t_{DDR}$	-	-	100	-	ns
Read data hold time		$t_{DHR}$	5	-	-	-	ns

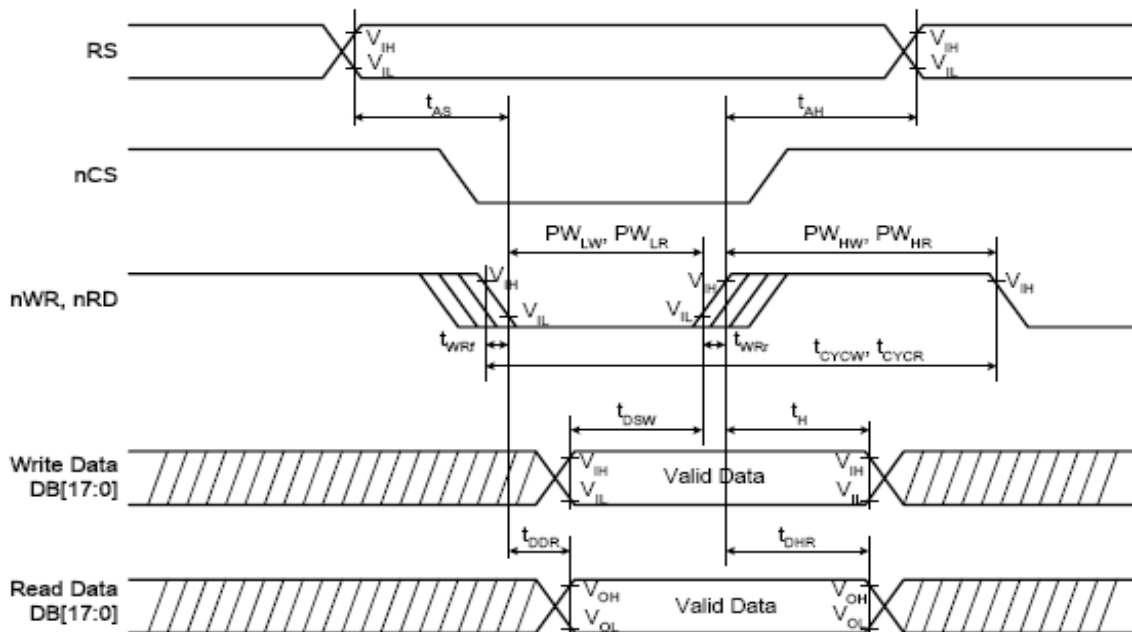



Messrs.					
Product Specification	Model:	MTF-TQ24NN731-LB	Rev. No.	Issued Date.	Page.
			B	Nov.26, 07	17 / 28

## 8. COMMAND LIST & INSTRUCTION DESCRIPTIONS

Refer to ILI9325 IC Specification

## 9. QUALITY STANDARD FOR LCD

### 9.1 Objective

This specification book is the standard for LCD module general inspection. And also this book will be refer to customer approval specification.

### 9.2 Scope

This specification book is applicable to general LCD module. If supplier has any doubt or requirement, then it can be discussed.

#### 9.2.1 Acceptable Quality Level

INSPECTION	SAMPLING PROCEDURES	A.Q.L
Major	MIL-STD-105E Inspection Level II Normal Inspection Single sample inspection	1
Minor	MIL-STD-105E Inspection Level II Normal Inspection Single sample inspection	1.5

#### Major defect :

A major defect is a defect that could result in failure or extremely reduction on the usability of the product for its intended purpose.

#### Minor defect :

A minor defect is one that does not materially reduce the usability of the product for its intended purpose or is a departure from established standards giving no significant bearing on the effective use or operation of the unit.

### 9.2.2 Inspection Conditions

#### 9.2.2.1 The environmental conditions for inspection shall be as follows

- Room Temperature : 25±10°C
- Humidity Temperature : 45±20%RH

#### 9.2.3 The external visual inspection

- The inspection shall be performed by using 40Watts fluorescent lamp for illumination and the distance between LCD and eyes of the inspector shall be 30cm or more.



Messrs.					
Product Specification	Model:	MTF-TQ24NN731-LB	Rev. No.	Issued Date.	Page.
			B	Nov.26, 07	18 / 28

#### 9.2.4 Inspection Item

Pinhole, Bright spot, Black spot, White spot, Black line, White Line, Foreign particle, Bubble	The color of a small area is different from the remainder. The phenomenon dose not change with voltage.
Contrast variation	The color of a small area is different from the remainder. The phenomenon change with voltage.
Glass defect	Glass crack, Chip
Operating	Function, Contrast, Uniformity, Components

#### 9.2.5 Definition of the Area

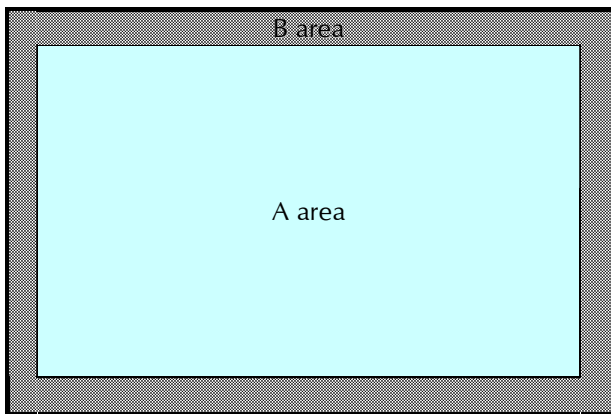

A area: Viewing Area  
 B area: Out of Viewing Area



Messrs.					
Product Specification	Model:	MTF-TQ24NN731-LB	Rev. No.	Issued Date.	Page.
			B	Nov.26, 07	19 / 28

### 9.3 Inspection specification

#### 9.3.1 Non-operating inspection specification

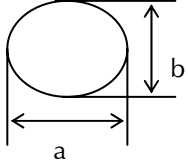
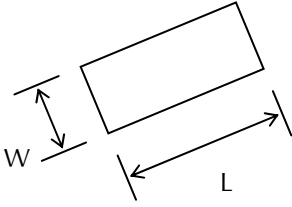
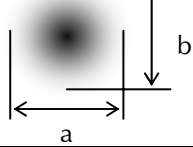
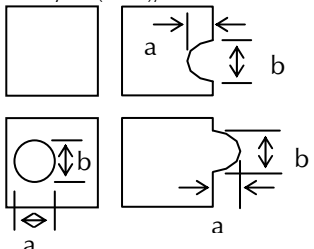
Class of defects	No.	Inspection Item	Criteria of defects	Acceptable Q'ty				
				Zone A	Zone B			
Major	1	Circuits	1. Circuit short	0	0			
			2. Circuit open					
Minor	2	Black spot, White spot, Bright spot, Foreign particle  $\phi = (a+b)/2$	A $\phi \leq 0.1$	Ignore				
			B $0.1 < \phi \leq 0.3$	3				
			C $0.3 < \phi$	0				
			Total defect point (B,C)			3		
			* Reject when 5 or more spots are gathered within 5mm circle.					
	3	Black line, White line 	A $W \leq 0.02$	-	*	Ignore		
			B $0.02 < W \leq 0.05$	$L \leq 3$	3			
			C $0.05 < W$	$3 < L$	0			
			Total defect point (B,C)				3	
			* Reject when 5 or more spots are gathered within 5mm circle.					
	4	Contrast variation 	A $\phi \leq 0.1$	Ignore		Ignore		
			B $0.1 < \phi \leq 0.3$	3				
			C $0.3 < \phi$	0				
			Total defect point (B,C)				3	
5	atter deformation $\phi = (a+b)/2$  $= (a+b)/2$	1. Pin hole			Ignore			
		A $\phi \leq 0.15$	Ignore					
		B $0.15 < \phi \leq 0.2$	2 (*)					
					0			
		* Two pin hole shall not formed in the single dot						
		2. Excess, void						
		A $a \leq 0.2$ and $b \leq 0.2$	Ignore		Ignore			
B $0.2 < a$ or $0.2 < b$	0							



Messrs.					
Product Specification	Model:	MTF-TQ24NN731-LB	Rev. No.	Issued Date.	Page.
			B	Nov.26, 07	20 / 28

Minor	6	Dot defect	A	Bright dot	$N \leq 0$	Ignore
			B	Dark dot	$N \leq 2$	
			C	Total Bright & Dark Dots	$N \leq 2$	
			* This inspection item does not apply to B/W LCD			
	7	Bubble between Polarizer and panel	A	$\phi \leq 0.3$	Ignore	Ignore
			B	$0.3 < \phi \leq 0.5$	2	
			C	$0.5 < \phi$	0	
	8	Polarizer scratch and particle	Circular : Same as inspection item No.2			Ignore
			Linear : Same as inspection item No.3			
	9	Polarizer Dent	A	$\phi \leq 0.2$	Ignore	Ignore
			B	$0.2 < \phi \leq 0.3$	2	
			C	$0.3 < \phi \leq 0.4$	1	
			D	$0.4 < \phi$	0	
			Total defect point (B,C)		3	
	10	Bubble in the Cell	Any size		0	0
11	Dirt on polarizer	Dirt which can be wiped easily should be accepted.				
12	Protection film	The protection film should not be stripped up to viewing area and the peeled off angle should not exceed 20 degrees.				
13	Polarizer shift	<ol style="list-style-type: none"> <li>Shifting in position should not exceed the glass outline dimension.</li> <li>Incomplete covering of the viewing area due to shifting is not allowed.</li> <li>Shifting in position should be within the tolerance (refer to module dimensional drawing)</li> </ol>				
14	Silicon	<ol style="list-style-type: none"> <li>Silicon must cover all circuits.</li> <li>Silicon thickness should be within specification (refer to module dimensional drawing)</li> </ol>				
15	Tape	<ol style="list-style-type: none"> <li>Location: refer to specification.</li> <li>Insufficient adhesive.</li> </ol>				
Major	16	TCP, FPC defect	Film or Pattern should not have crack.			
	17	Components	Missing components not allowed.			



Messrs.					
Product Specification	Model:	MTF-TQ24NN731-LB	Rev. No.	Issued Date.	Page.
			B	Nov.26, 07	21 / 28

Class of defects	No.	Inspection Item	Criteria of defects
Major	1	No display	--
	2	Abnormal operation	--
	3	Contrast defect	Judge according to module specification. Establish boundary sample if required.
	4	Viewing angle defect	Judge according to module specification. Establish boundary sample if required.
	5	Excess power consumption	Judge according to module specification.
	6	Back-light, LED defect	1. No lit-on 2. Different color 3. Low brightness
	7	Speaker, Vibrator defect	1. No operation 2. Abnormal operation
Minor	8	Cross-talk defect	No noticeable crosstalk. Establish boundary sample if required.
	9	Uneven brightness	No noticeable unevenness allowed. Establish boundary sample if required.
	10	Uneven color	No noticeable unevenness allowed. Establish boundary sample if required.
	11	Spot, Pinhole, Foreign particle, Line	Same as in Chapter 7.1



Messrs.					
Product Specification	Model:	MTF-TQ24NN731-LB	Rev. No.	Issued Date.	Page.
			B	Nov.26, 07	22 / 28

## 10. RELIABILITY CONDITION FOR LCM

### 10.1 LCM Reliability Test

#### 10.1.1 Reliability Test Condition

No.	TFT	Item	Condition	Test time	Note
1	V	High temp. operating	80°C	240 Hrs	--
2	V	Low temp. operating	-30°C	240 Hrs	--
3	V	High temp. storage	70°C	240 Hrs	--
4	V	Low temp. storage	-20°C	240 Hrs	--
5	V	High Temp / High Humidity Storage	T = 60°C /90%. For (But no condensation dew)	240 Hrs	--
6	V	Thermal Shock	-20 ~ 80°C	30 cycles	--
7	V	Electrostatic discharge	150pF, 330Ω, ±2KV, Air	--	Non-operation

Note: Reliability Test Criteria:

- All judgments of display are performed after temp of panel returns to room temperature
- Display function should be no change under normal operating condition.
- Under no condensation of dew
- Each cycle: -20°C(30min)  $\xrightarrow{\uparrow}$  -25°C  $\xrightarrow{\uparrow}$  +80°C (30min)  $\xrightarrow{\uparrow}$  -25°C  

$\uparrow$  5 (min)  $\uparrow$

#### 10.1.2 Operating Test Pattern

No.	Items	Test Pattern
1	Test Pattern in Driving Condition	1. Full Red 2. Full Green 3. Full Blue 4. Gradation (horizontal) 5. Gradation (vertical) 6. Character (111111) 7. Full White 8. Full Black 9. Black Line (horizontal) 10. Black Line (vertical) 11. Mosaic (1X1) The Test Pattern is changed 1sec. The same Pattern are repeated.
2	Black Square	Black Window and White Background



Messrs.					
Product Specification	Model:	MTF-TQ24NN731-LB	Rev. No.	Issued Date.	Page.
			B	Nov.26, 07	23 / 28

### 10.1.3 Test Method

The method of visual inspection is equal to the appearance standard. Evaluation and assessment made two hours after return to room temperature ( $25 \pm 5^{\circ}\text{C}$ ). The LCDs subjected to the test must not have dew condensation.

The test pattern is gray scale and the operating voltage sweep from  $V_{th}$  to  $V_{sat}$  variable.

The non-uniformity and other appearance are checked in LCD.

### 10.1.4 Result Evaluation Criteria

There should be no change which might affect the practical display function when the display quality test is conducted under normal operating condition.

### 10.1.5 Life time

Life time expectancy of LCD Panel is approximately 50,000 hours under the room environment. Definition on the termination of life time is deterioration of contrast ratio by one fifth against initial value.

### 10.1.6 Basic rule for Reliability test

- \* Place all the samples under room temperature & humidity for 24 hours after reliability stressing.
- \* Room environment means  $25 \pm 10^{\circ}\text{C}$ ,  $45 \pm 20\% \text{RH}$
- \* There should be no condensation during the test.
- \* One LCD module shall be used for one test item only and once.

### 10.1.7 Judgment Criteria for reliability test No. 1-2

- \* Contrast (or Brightness) ratio variation is within 50% of the initial value.
- \* No abnormal function
- \* No extreme decay on appearance

### 10.1.8 Life time

Main Display (LCD module) : Life time expectancy of LCD Panel is approximately 50,000 hours under the room environment.

Definition on the termination of life time is deterioration of contrast ratio by one fifth against initial value. ( $25 \pm 10^{\circ}\text{C}$ ,  $45 \pm 20\% \text{RH}$ ). Life time shall be defined as one of below cases;

- When the contrast ratio for Main display reaches 30% of initial condition and the brightness (or luminance with polarizer) for sub display reaches 50% of initial condition.
- When the appearance degradation appears.



Messrs.					
Product Specification	Model:	MTF-TQ24NN731-LB	Rev. No.	Issued Date.	Page.
			B	Nov.26, 07	24 / 28

## 11. PRECAUTIONS





### 11.1 Operation

Burn-in sometimes happens when the same character was displayed at a long time. Therefore, to prevent Burn-in, it is recommended to set up a Screen-saver function.

### 11.2 Safety

The liquid crystal in the LCD is poisonous, DO NOT put it in your mouth. If the liquid crystal touches your skin or clothes, wash it off immediately using soap and water.

### 11.3 Handling







	<p>a. The LCD module shall be installed flat, without twisting or bending.</p> <p>b. COF or FPC has narrow pattern width, so easily become open circuit by external force. DO NOT apply pressure to COF or FPC especially in bending area.</p>
	<p>c. To avoid damage in appearance or malfunction, DO NOT subject the module to mechanical shock or to excessive force on its surface.</p>
	<p>d. The polarizer attached to the display is very easy to damage, handle it with care to avoid scratching.</p>
	<p>e. To avoid contamination on the display surface, DO NOT touch the display surface with bare hands.</p> <p>f. Provide a space so that the LCD module does not come into contact with other components.</p>



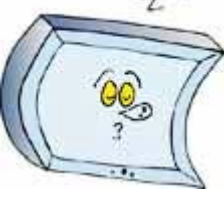

Messrs.

Product Specification	Model:	MTF-TQ24NN731-LB	Rev. No.	Issued Date.	Page.
			B	Nov.26, 07	25 / 28

	<p>g. To protect the LCD panel from external pressure, put covering glass (acrylic board or similar board) to keep appropriate space between them.</p>
	<p>h. Be careful for condensation at sudden temperature change. Condensation makes damage to polarizer or electrical contacted parts. And after fading condensation, smear or spot will occur.</p>
	<p>i. Property of semiconductor devices may be affected when they are exposed to light possibly resulting in malfunctioning of the ICs. To prevent such malfunctioning of the ICs, your design and mounting layout done are so that the IC is not exposed to light in actual use.</p>
	<p>j. Strong light exposure causes degradation of color filter. It may not recover</p>
	<p>k. DO NOT contact with water to avoid Metal corrosion.</p> <p>l. When it is not in use, the screen must be turned off or the pattern must be frequently changed by a screen saver. If it displays the same pattern for a long period of time, brightness down/image sticking may develop due to the LCD structure.</p>
	<p>m. Never disassemble LCD product under any circumstances. If unqualified operators or users assemble the product after disassembling it, it may not function or its operation may be seriously affected.</p>



Messrs.					
Product Specification	Model:	MTF-TQ24NN731-LB	Rev. No.	Issued Date.	Page.
			B	Nov.26, 07	26 / 28

#### 11.4 Static electricity

Since a module is composed of electronic circuits, it is not strong to electrostatic discharge.

	<ol style="list-style-type: none"> <li>The LCD module shall be installed flat, without twisting or bending. Ground soldering iron tips, tools and testers when they operate.</li> <li>Ground your body when handling the products.</li> <li>DO NOT apply voltage to the input terminal without applying power supply.</li> <li>DO NOT apply voltage that exceeds the absolute maximum rating.</li> <li>Store the products in an anti-electrostatic container.</li> <li>Peel off protect tape, attached to polarizer, slowly to minimize ESD damage.</li> </ol>
-----------------------------------------------------------------------------------	----------------------------------------------------------------------------------------------------------------------------------------------------------------------------------------------------------------------------------------------------------------------------------------------------------------------------------------------------------------------------------------------------------------------------------------------------------------------------------------------------------------------------------------------------------------

#### 11.5 Storage

	<p>Store the products in a dark place at +5 ~ +25 degree C, low humidity (50%RH or less). DO NOT store the products in an atmosphere containing organic solvents or corrosive gases.</p>
-------------------------------------------------------------------------------------	----------------------------------------------------------------------------------------------------------------------------------------------------------------------------------------------

#### 11.6 Cleaning

	<ol style="list-style-type: none"> <li>DO NOT wipe the polarizer with dry cloth, as it might cause scratch.</li> <li>Wipe the polarizer with a soft cloth soaked with petroleum IPA, other chemical might damage.</li> </ol>
-------------------------------------------------------------------------------------	------------------------------------------------------------------------------------------------------------------------------------------------------------------------------------------------------------------------------

#### 11.7 Waste

	<p>When dispose of LCD module, manage it at the production waste according to the relevant laws and regulations.</p>
-------------------------------------------------------------------------------------	----------------------------------------------------------------------------------------------------------------------



Messrs.					
Product Specification	Model:	MTF-TQ24NN731-LB	Rev. No.	Issued Date.	Page.
			B	Nov.26, 07	27 / 28

## 12. WARRANTY

This product has been manufactured to your company's specifications as a part for use in your company's general electronic products. It is guaranteed to perform according to delivery specifications. For any other use apart from general electronic equipment, we cannot take responsibility if the product is used in medical devices, nuclear power control equipment, aerospace equipment, fire and security systems, or any other applications in which there is a direct risk to human life and where extremely high levels of reliability are required. If the product is to be used in any of the above applications, we will need to enter into a separate product liability agreement.

- 1 We cannot accept responsibility for any defect, which may arise from additional manufacturing of the product (including disassembly and reassembly), after product delivery.
- 2 We cannot accept responsibility for any defect, which may arise after the application of strong external force to the product.
- 3 We cannot accept responsibility for any defect, which may arise due to the application of static electricity after the product has passed your company's acceptance inspection procedures.
- 4 We cannot accept responsibility for industrial property, which may arise through the use of your product, with exception to those issues relating directly to the structure or method of manufacturing of our product. Microtips-origin longer than one year from Microtips production.

## 13. DIMENSIONAL OUTLINES

See next page.....



*Microtips Technology Inc.*

