



MTL4500/MTL5500 Series

Intrinsic safety (IS) isolators for hazardous area interfacing

- 3-port isolation as standard
- Highest module/channel packing densities
- Low power dissipation
- Quick install and release mechanism
- Multi-channel I/O modules
- Broken line and earth-fault protection
- Compatible with preceding MTL isolator series for pluggable replacements
- Various models assessed for use in Functional Safety applications



MTL's latest generation of IS interfaces utilises an innovative "One-Core" technology to ensure the highest quality and availability while maintaining maximum flexibility at lowest cost. Incorporating advanced circuit design, a common set of components and innovative isolating transformer construction, they achieve a significant reduction in power consumption while increasing channel packing densities. The compact, 16mm wide design reduces weight and gives exceptionally high packing density. They build on the proven success of the MTL2000, 3000, 4000 and 5000 Series to bring the benefits of new developments in galvanic isolation without compromising the reliability of the designs from which they have evolved.

The backplane mounting MTL4500 Series is designed with system vendors in mind for "project-focussed" applications such as Distributed Control System (DCS), Emergency Shutdown Systems (ESD) and Fire and Gas monitoring (F&G).

The reduced power consumption and high efficiency enable high signal density to be achieved together with improved freedom in cabinet layout and design. Easy integration

with the input/output assemblies of control or safety instrumentation systems not only simplifies project engineering but also reduces installation and maintenance costs.

A multiway connector to the backplane provides safe-area and power supply connections, while hazardous-area connections plug into the front of the module, simplifying installation and maintenance and reducing time, cost, and the risk of errors.

The DIN-rail mounting MTL5500 Series meets the needs of the IS interface market for "application focussed" projects, ranging from single instrument loops, through to fully equipped cabinets, across all industries where hazardous areas exist.

The MTL5500 clips quickly onto DIN rail, so it is compatible with the industry-standard mounting system. Wiring is simplified by plug-in safe- and hazardous-area connectors, and a power plug which accepts a power bus; it all leads to quicker insertion, fewer wiring errors and trouble-free, tidier installations.

Line fault detection (LFD) facilities are provided across the range of I/O functions; on the switch/proximity detectors, the

MTL4523/5523 solenoid/alarm drivers and the isolating drivers. Analogue input units such as the MTL4541/5541 provide line fault detection by repeating o/c or s/c currents to the safe-area control system.

Status LEDs, configuration switches and ports are located on the top or side of individual modules, as appropriate, for easy access.

Both new series have been designed for compatibility with earlier models. The MTL4500 series provides plug-replacements for earlier MTL4000 series units, while the MTL5500 models can easily replace MTL5000 series units. Each offer the latest in modern technology and efficiency without compromise.

In addition to their use in IS circuits, specific models within the MTL4500 and MTL5500 series have been assessed and approved for use in Functional Safety applications. These have been verified under the certified Functional Safety Management (FSM) programme implemented by MTL.

ISOLATOR FUNCTION SELECTOR



MTL4500 (Backplane)

Digital Input

MTL4501-SR
MTL4504
MTL4510
MTL4510B
MTL4511
MTL4513
MTL4514/B
MTL4514D
MTL4516
MTL4516C
MTL4517

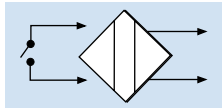

MTL5500 (DIN-rail)

MTL5501-SR
-
MTL5510
MTL5510B
MTL5511
MTL5513
MTL5514
MTL5514D
-
MTL5516C
MTL5517

FSM

Channels Function

✓ 1 fail-safe solid-state output + LFD alarm
✓ 1 switch/prox input, phase reversal + LFD
4 switch/prox input, solid-state output
4 multi-function switch/prox input, solid-state output
✓ 1 switch/prox input, c/o relay output
2 switch/prox input, solid-state output
✓ 1 switch/prox input, relay + LFD
✓ 1 switch/prox input, dual output relay
✓ 2 switch/prox input, relay + LFD outputs
✓ 2 switch/prox input, c/o relay + LFD outputs
✓ 2 switch/prox input, relay + LFD outputs

Digital Output

MTL4521
MTL4521L
-
MTL4523
MTL4523L
MTL4523R
MTL4523V
MTL4524
MTL4524S
MTL4525
MTL4526

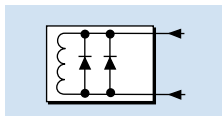

MTL5521
-
MTL5522
MTL5523
-
-
MTL5523V
MTL5524
-
MTL5525
MTL5526

✓ 1 loop powered solenoid driver
✓ 1 loop powered solenoid driver, IIC
✓ 1 loop powered solenoid driver, IIB
✓ 1 solenoid driver with LFD
✓ 1 loop powered solenoid driver with LFD
✓ 1 solenoid driver with reverse LFD
✓ 1 solenoid driver with LFD, IIC
✓ 1 switch operated solenoid driver
✓ 1 switch operated solenoid driver, 24V override
✓ 1 switch operated solenoid driver, low power
2 switch operated relay

Pulse & Vibration

MTL4531
MTL4532
-

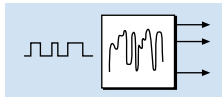

MTL5531
MTL5532
MTL5533

1 vibration probe interface
1 pulse isolator, digital or analogue output
2 vibration probe interface

Analogue Input

MTL4541
MTL4541A
MTL4541AS
MTL4541S
MTL4541T
MTL4544
MTL4544A
MTL4544AS
MTL4544S
MTL4544D

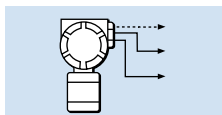

MTL5541
MTL5541A
MTL5541AS
MTL5541S
-
MTL5544
MTL5544A
MTL5544AS
MTL5544S
MTL5544D

✓ 1 2/3 wire transmitter repeater
1 transmitter repeater, passive input
1 transmitter repeater, passive input, current sink
✓ 1 2/3 wire transmitter repeater, current sink
1 2/3 wire transmitter repeater
✓ 2 2/3 wire transmitter repeater
2 transmitter repeater, passive input
2 transmitter repeater, passive input, current sink
✓ 2 2/3 wire transmitter repeater, current sink
✓ 1 2/3 wire transmitter repeater, dual output

Analogue Output

MTL4546
MTL4546S
MTL4546Y
MTL4549
MTL4549Y

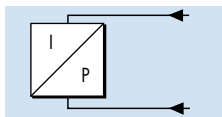

MTL5546
-
MTL5546Y
MTL5549
MTL5549Y

✓ 1 4-20mA smart isolating driver + LFD
1 4-20mA smart isolating driver + LFD
✓ 1 4-20mA smart isolating driver + oc LFD
✓ 2 4-20mA smart isolating driver + LFD
✓ 2 4-20mA smart isolating driver + oc LFD

Fire & Smoke

MTL4561

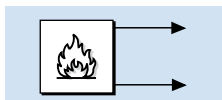

MTL5561

✓ 2 loop-powered, for fire and smoke detectors

Temperature Input

MTL4575
MTL4576-RTD
MTL4576-THC
MTL4581
-

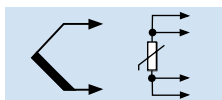

MTL5575
MTL5576-RTD
MTL5576-THC
MTL5581
MTL5582

1 temperature converter, THC or RTD
2 temperature converter, RTD
2 temperature converter, THC
1 mV/mV isolator
1 RTD/RTD isolator

General

MTL4599
MTL4599N

MTL5599
-

- dummy module
- general purpose feed-through module



EUROPE (EMEA): +44 (0)1582 723633
enquiry@mtl-inst.com

THE AMERICAS: +1 800 835 7075
csinfo@mtl-inst.com

ASIA-PACIFIC: +65 6 645 9888
sales.mtlsing@cooperindustries.com

EPS45/5500 Rev10 041113

MTL4501-SR – MTL5501-SR

FAIL-SAFE SWITCH/PROXIMITY-DETECTOR INTERFACE

with LFD

With the MTLx501-SR, a fail-safe switch/proximity detector located in the hazardous area can control an isolated fail-safe electronic output. The MTLx501-SR also provides relay alarm contacts to signal line-fault conditions. The MTLx501-SR is for use with approved fail-safe sensors in loops that require operation up to SIL3 according to the functional safety standard IEC 61508.

SPECIFICATION

See also common specification



Number of channels

One

Location of switches

Zone 0, IIC, T6 hazardous area

Div. 1, Group A hazardous location

Location of proximity detector

Zone 0, IIC, T4–6, hazardous location

Div 1, Group A, hazardous location

Voltage applied to sensor

8.6V dc max from 1k Ω

Input/output characteristics

Input value in sensor circuits	Fail-safe output	Operation	LFD contacts
$2.9\text{mA} < I_s < 3.9\text{mA}$	ON	Normal	CLOSED
$I_s < 1.9\text{mA} \ \& \ I_s > 5.1\text{mA}$	OFF	Normal	CLOSED
$I_s < 50\mu\text{A}$	OFF	Broken line	OPEN
$R_s < 100\Omega$	OFF	Shorted line	OPEN

Note: I_s = sensor current

Fail-safe electronic output

Output on: 24V nominal

Output off: 0V dc, max < 5V dc

Load: 750 Ω to 10k Ω

Maximum on-state current: 25mA (at 750 Ω)

Short-circuit current: 30mA

Line fault detection (LFD)

LFD relay output: contacts open when line fault detected

Switch characteristics: 0.3A 110V ac/dc; 1A 35V dc; 30W/33VA

MTL4501-SR

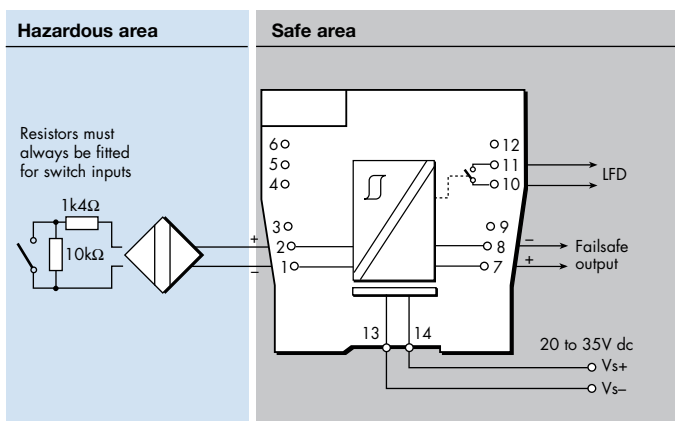

MTL5501-SR

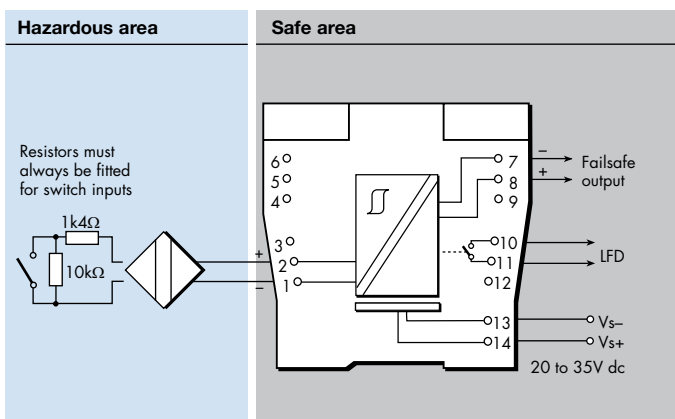

LED indicators

Green: power indication

Yellow: channel status, on when fail-safe output energised

Red: LFD indication, flashing when line fault detected

Power requirements, Vs

@ Supply voltage	750 Ω load	typ. load
20V dc	100mA	70mA
24V dc	90mA	60mA
35V dc	65mA	45mA

Power dissipation within unit

@ Supply voltage	750 Ω load	typ. load
20V dc	1232mW	1160mW
24V dc	1392mW	1200mW
35V dc	1507mW	1335mW

Safety description

$U_o = \pm 9.7\text{V}$, $I_o = 30\text{mA}$, $P_o = 0.07\text{W}$, $C_i = 0\text{nF}$, $L_i = 0\text{mH}$

$U_m = 253\text{V}$



Safety integrity level (SIL)

Highest level in single in-line subsystem - SIL3 (in accordance with IEC61508-2)

See data on MTL web site and refer to the safety manual.

The given data is only intended as a product description and should not be regarded as a legal warranty of properties or guarantee. In the interest of further technical developments, we reserve the right to make design changes.



EUROPE (EMEA): +44 (0)1582 723633
enquiry@mtl-inst.com

THE AMERICAS: +1 800 835 7075
csinfo@mtl-inst.com

ASIA-PACIFIC: +65 6 645 9888
sales.mtlsing@cooperindustries.com

EPsX501SR Rev4 200913

MTL4504

SWITCH/ PROXIMITY DETECTOR INTERFACE

1-channel with LFD and phase reversal

The MTL4504 enables a safe-area load to be controlled, through a relay, by a proximity detector or switch located in a hazardous area. Line faults are signalled through a separate relay and indicated on the top of the module. MTBF information for the LFD relay is available from MTL to allow the failure rate for the LFD relay to be calculated when used in the critical path with the output relay for safety critical applications. Switches are provided to select phase reversal and to enable the line fault detection.

SPECIFICATION

See also common specification



Number of channels

One

Location of switch

Zone 0, IIC, T6 hazardous area
Div.1, Group A, hazardous location

Location of proximity detector

Zone 0, IIC, T4–6 hazardous area, if suitably certified
Div.1, Group A, hazardous location

Hazardous-area inputs

Inputs conforming to BS EN60947–5–6:2001 standards for proximity detectors (NAMUR)

Voltage applied to sensor

7 to 9V dc from $1k\Omega \pm 10\%$

Input/output characteristics

Normal phase

Outputs closed if input $> 2.1mA$ ($< 2k\Omega$ in input circuit)

Outputs open if input $< 1.2mA$ ($> 10k\Omega$ in input circuit)

Hysteresis: $200\mu A$ (650Ω) nominal

Line fault detection (LFD) (when selected)

User-selectable via switches on the side of the unit. Line faults are indicated by an LED. Line fault relay is de-energised and channel output relay de-energised if input line-fault detected

Open-circuit alarm on if $I_{in} < 50\mu A$

Open-circuit alarm off if $I_{in} > 250\mu A$

Short-circuit alarm on if $R_{in} < 100\Omega$

Short-circuit alarm off if $R_{in} > 360\Omega$

Note: Resistors must be fitted when using the LFD facility with a contact input
 500Ω to $1k\Omega$ in series with switch
 $20k\Omega$ to $25k\Omega$ in parallel with switch

Safe-area output

Channel: Single pole relay with changeover contacts

LFD: Single pole relay with changeover contacts

Note: reactive loads must be adequately suppressed

Relay characteristics

Response time: 10ms maximum

Contact rating: 10W, 0.5A, 35V dc

MTL4504

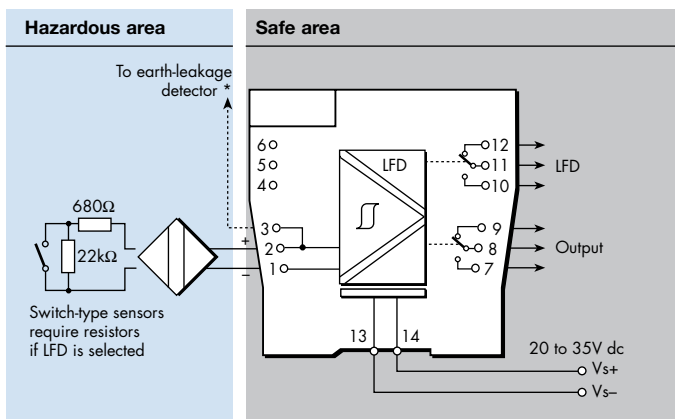

* Signal plug HAZ1-3 is required for access to this function

LED indicators

Green: power indication

Yellow: channel status, on when output energised

Red: LFD indication, on when line fault detected

Maximum current consumption

25mA at 24V dc

Power dissipation within unit

0.6W at 24V

Safety description

$U_o=10.5V$ $I_o=14mA$ $P_o=37mW$ $U_m = 253V$ rms or dc



SIL capable

These models have been assessed for use in IEC 61508 functional safety applications.

See data on MTL web site and refer to the safety manual.

The given data is only intended as a product description and should not be regarded as a legal warranty of properties or guarantee. In the interest of further technical developments, we reserve the right to make design changes.



EUROPE (EMEA): +44 (0)1582 723633
enquiry@mtl-inst.com

THE AMERICAS: +1 800 835 7075
csinfo@mtl-inst.com

ASIA-PACIFIC: +65 6 645 9888
sales.mtlsing@cooperindustries.com

EPS4504 Rev3 200913

MTL4510 – MTL5510

SWITCH/ PROXIMITY DETECTOR INTERFACE

4-channel, digital input

The MTLx510 enables four solid-state outputs in the safe area to be controlled by up to four switches or proximity detectors located in a hazardous area. Each pair of output transistors shares a common terminal and can switch +ve or -ve polarity signals. A range of module configurations is available (see Table 1) through the use of selector switches. When proximity detector modes are selected, LFD is enabled and the output switches to OFF if a line fault is detected.

SPECIFICATION

See also common specification

Number of channels

4, configured by switches

Location of switches

Zone 0, IIC, T6 hazardous area
Div 1, Group A hazardous location

Location of proximity detectors

Zone 0, IIC, T4-6 hazardous area if suitably certified
Div 1, Group A, hazardous location

Hazardous-area inputs

Inputs conforming to BS EN60947-5-6:2001 standards for proximity detectors (NAMUR)

Voltage applied to sensor

7 to 9V dc from $1k\Omega \pm 10\%$

Input/output characteristics

Normal phase

Outputs closed if input $> 2.1mA$ ($< 2k\Omega$ in input circuit)

Outputs open if input $< 1.2mA$ ($> 10k\Omega$ in input circuit)

Hysteresis: $200\mu A$ (650Ω) nominal

Line fault detection (LFD) (when selected)

User-selectable via switches on the side of the unit.

Open-circuit alarm on if $I_{in} < 50\mu A$

Open-circuit alarm off if $I_{in} > 250\mu A$

Short-circuit alarm on if $R_{in} < 100\Omega$

Short-circuit alarm off if $R_{in} > 360\Omega$

Note: Resistors must be fitted when using the LFD facility with a contact input
 500Ω to $1k\Omega$ in series with switch
 $20k\Omega$ to $25k\Omega$ in parallel with switch

Safe-area outputs

Floating solid-state outputs compatible with logic circuits

Operating frequency: dc to 500Hz

Max. off-state voltage: $\pm 35V$

Max. off-state leakage current: $\pm 50\mu A$

Max. on-state resistance: 25Ω

Max. on-state current: $\pm 50mA$

LED indicators

Green: power indication

Yellow: four: on when output active

Red: LFD indication + faulty channel's yellow LED flashes

Maximum current consumption

40mA at 24V (with all output channels energised)

Power dissipation within unit

0.96W at 24V, with 10mA loads

Safety description (each channel)

$U_o=10.5V$ $I_o=14mA$ $P_o=37mW$ $U_m = 253V$ rms or dc

MTL4510

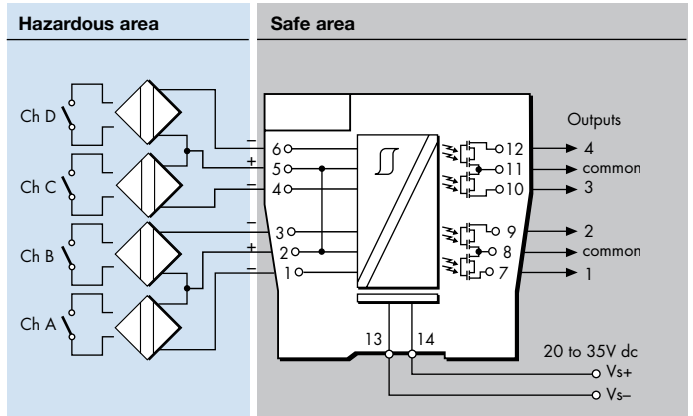

MTL5510

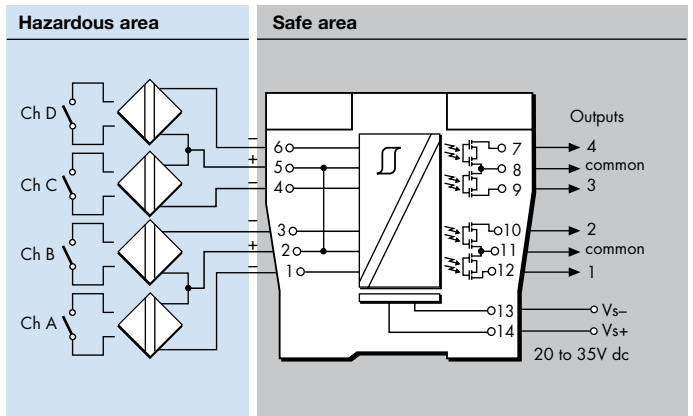

Table 1 - Mode options

MODE	o/p 1	o/p 2	o/p 3	o/p 4	i/p type
0	chA	chB	chC	chD	switch
1	chA rev.	chB	chC	chD	
2	chA	chB rev.	chC	chD	
3	chA	chB	chC rev.	chD	
4	chA	chB	chC	chD rev.	
5	chA rev.	chB	chC rev.	chD	
6	chA	chB rev.	chC	chD rev.	
7	chA rev.	chB rev.	chC rev.	chD rev.	prox. detector + LFD
8	chA	chB	chC	chD	
9	chA rev.	chB	chC	chD	
10	chA	chB rev.	chC	chD	
11	chA	chB	chC rev.	chD	
12	chA	chB	chC	chD rev.	
13	chA rev.	chB	chC rev.	chD	
14	chA	chB rev.	chC	chD rev.	
15	chA rev.	chB rev.	chC rev.	chD rev.	

See Instruction Manual INM4500 or INM5500 for further mode information.

The given data is only intended as a product description and should not be regarded as a legal warranty of properties or guarantee. In the interest of further technical developments, we reserve the right to make design changes.



EUROPE (EMEA): +44 (0)1582 723633
enquiry@mtl-inst.com

THE AMERICAS: +1 800 835 7075
csinfo@mtl-inst.com

ASIA-PACIFIC: +65 6 645 9888
sales.mtlsing@cooperindustries.com

EPSx510 Rev3 041113

MTL4510B – MTL5510B

SWITCH/ PROXIMITY DETECTOR INTERFACE

4-channel, multi-function, digital input

The MTL4510B enables four solid-state outputs in the safe area to be controlled by up to four switches or proximity detectors located in a hazardous area. Each pair of output transistors shares a common terminal and can switch +ve or -ve polarity signals. A range of module configurations is available (see Table 1) through the use of selector switches. These include start/stop operations and pulse output modes.

SPECIFICATION

See also common specification

Number of channels

4, configured by switches

Location of switches

Zone 0, IIC, T6 hazardous area
Div 1, Group A hazardous location

Location of proximity detectors

Zone 0, IIC, T4-6 hazardous area if suitably certified
Div 1, Group A, hazardous location

Hazardous-area inputs

Inputs conforming to BS EN60947-5-6:2001 standards for proximity detectors (NAMUR)

Voltage applied to sensor

7 to 9V dc from 1k Ω \pm 10%

Input/output characteristics

Normal phase

Outputs closed if input > 2.1mA (< 2k Ω in input circuit)

Outputs open if input < 1.2mA (> 10k Ω in input circuit)

Hysteresis: 200 μ A (650 Ω) nominal

Line fault detection (LFD) (when selected)

User-selectable via switches on the side of the unit.

Open-circuit alarm on if $I_{in} < 50\mu$ A

Open-circuit alarm off if $I_{in} > 250\mu$ A

Short-circuit alarm on if $R_{in} < 100\Omega$

Short-circuit alarm off if $R_{in} > 360\Omega$

Note: Resistors must be fitted when using the LFD facility with a contact input
500 Ω to 1k Ω in series with switch
20k Ω to 25k Ω in parallel with switch

Safe-area outputs

Floating solid-state outputs compatible with logic circuits

Operating frequency: dc to 500Hz

Max. off-state voltage: \pm 35V

Max. off-state leakage current: \pm 50 μ A

Max. on-state resistance: 25 Ω

Max. on-state current: \pm 50mA

LED indicators

Green: power indication

Yellow: four: on when output active

Red: LFD indication + faulty channel's yellow LED flashes

Maximum current consumption

40mA at 24V (with all output channels energised)

Power dissipation within unit

0.96W at 24V, with 10mA loads

Safety description (each channel)

$U_o=10.5V$ $I_o=14mA$ $P_o=37mW$ $U_m = 253V$ rms or dc

MTL4510B

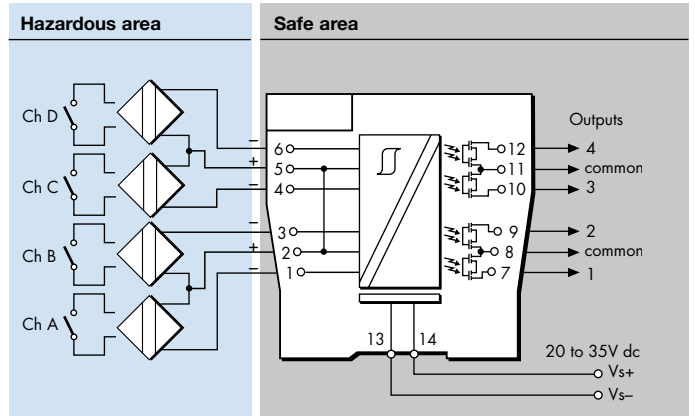

MTL5510B

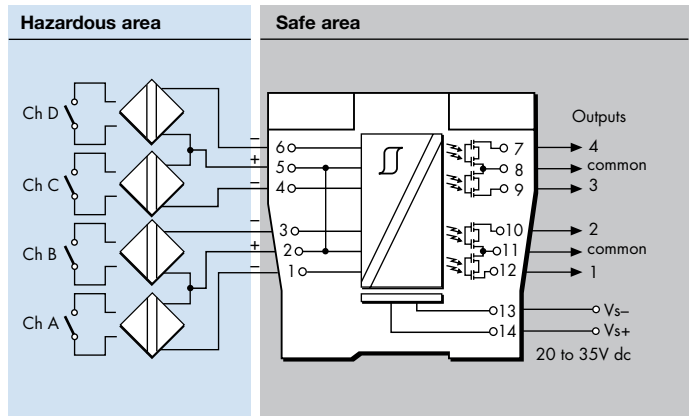

Table 1 - Mode options

MODE	Function	Equivalent*
0	4-ch switch input,	MTLx510
1	2-ch each channel one input, two outputs	MTL4016
2	As mode 1 but with phase of one output reversed	MTL4016
3	2-ch, 2-pole changeover output	
4	1-ch with line fault output	MTLx014
5	As mode 4 with changeover outputs	
6	1-ch with start-stop latch	MTL2210B
7	4-ch switch input,	MTLx510
8	4-ch switch input,	MTLx510
9	2-ch with line fault output	MTLx017
10	As mode 9 with LFD changeover	
11	As mode 10 with phase reversed	
12	3-ch with normally-open LFD output	
13	3-ch with normally-closed LFD output	
14	2-ch monostable, pulse stretcher	
15	4-ch switch input	MTLx510

* Note: that terminal connections may not be the same on these models, and x can mean either '4' or '5'.

See Instruction Manual INM4500 or INM5500 for further mode information.

The given data is only intended as a product description and should not be regarded as a legal warranty of properties or guarantee. In the interest of further technical developments, we reserve the right to make design changes.



EUROPE (EMEA): +44 (0)1582 723633
enquiry@mtl-inst.com

THE AMERICAS: +1 800 835 7075
csinfo@mtl-inst.com

ASIA-PACIFIC: +65 6 645 9888
sales.mtlsing@cooperindustries.com

EPSx510B Rev3 041113

MTL4511 – MTL5511

SWITCH/ PROXIMITY

DETECTOR INTERFACE

1-channel, with line fault detection

The MTLx511 enables a safe-area load to be controlled by a switch or proximity detector located in a hazardous-area. When selected, open or short circuit conditions in the field wiring are detected by the line-fault-detect (LFD) facility and also indicated on the top of the module. Phase reversal for the channel is selected by a switch on the side of the module and output is provided by changeover relay contacts.

SPECIFICATION

See also common specification



Number of channels

One

Location of switches

Zone 0, IIC, T6 hazardous area

Div. 1, Group A hazardous location

Location of proximity detector

Zone 0, IIC, T4–6 hazardous area if suitably certified

Div. 1, Group A hazardous location

Hazardous-area inputs

Inputs conforming to BS EN60947–5–6:2001 standards for proximity detectors (NAMUR)

Voltage applied to sensor

7 to 9V dc from $1k\Omega \pm 10\%$

Input/output characteristics

Normal phase

Outputs closed if input $> 2.1mA$ ($< 2k\Omega$ in input circuit)

Outputs open if input $< 1.2mA$ ($> 10k\Omega$ in input circuit)

Hysteresis: 200 μA (650 Ω) nominal

Line fault detection (LFD) (when selected)

User-selectable via switches on the side of the unit. A line fault is indicated by an LED. The channel output relay is de-energised if an input line fault is detected.

Open-circuit alarm on if $I_{in} < 50\mu A$

Open-circuit alarm off if $I_{in} > 250\mu A$

Short-circuit alarm on if $R_{in} < 100\Omega$

Short-circuit alarm off if $R_{in} > 360\Omega$

Note: Resistors must be fitted when using the LFD facility with a contact input
500 Ω to 1k Ω in series with switch
20k Ω to 25k Ω in parallel with switch

Safe-area output

Single pole relay with changeover contacts

Note: reactive loads must be adequately suppressed

Relay characteristics

	MTL4511	MTL5511
Response time:	10ms maximum	10ms maximum
Contact rating (Safe Area):	10W, 0.5A, 35V dc	250V ac, 2A, $\cos\phi > 0.7$, 40V dc, 2A, resistive load
Contact rating (Zone 2):	10W, 0.5A, 35V dc	35V, 2A, 100VA.

MTL4511

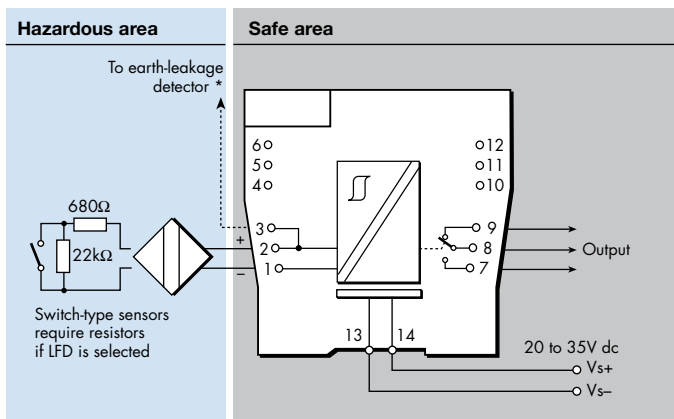

MTL5511

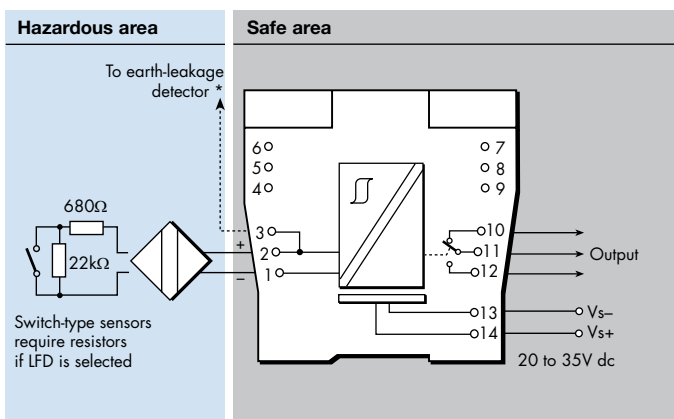

* Signal plug HAZ1-3 is required for access to this function

LED indicators

Green: power indication

Yellow: channel status, on when output energised

Red: LFD indication, on when line fault detected

Maximum current consumption

25mA at 24V

Power dissipation within unit

0.6W at 24V

Safety description (each channel)

$U_o=10.5V$ $I_o=14mA$ $P_o=37mW$ $U_m=253V$ rms or dc



SIL capable

These models have been assessed for use in IEC 61508 functional safety applications.

See data on MTL web site and refer to the safety manual.

The given data is only intended as a product description and should not be regarded as a legal warranty of properties or guarantee. In the interest of further technical developments, we reserve the right to make design changes.



EUROPE (EMEA): +44 (0)1582 723633
enquiry@mtl-inst.com

THE AMERICAS: +1 800 835 7075
csinfo@mtl-inst.com

ASIA-PACIFIC: +65 6 645 9888
sales.mtl@cooperindustries.com

EPSx511 Rev4 200913

MTL4513 – MTL5513

SWITCH/ PROXIMITY DETECTOR INTERFACE

2-channel, line fault detection, phase reversal

The MTLx513 enables two solid-state outputs in the safe area to be controlled by two switches or proximity detectors located in the hazardous area. The Ch1/Ch2 output transistors share a common terminal and can switch +ve or -ve polarity signals. Independent output phase reversal and line fault detection are enabled via switches for each output. LFD indication is provided on the top of the module.

SPECIFICATION

See also common specification

Number of channels

Two

Location of switches

Zone 0, IIC, T6 hazardous area

Div. 1, Group A hazardous location

Location of proximity detectors

Zone 0, IIC, T4–6 hazardous area if suitably certified

Div. 1, Group A hazardous location

Hazardous-area inputs

Inputs conforming to BS EN60947–5–6:2001 standards for proximity detectors (NAMUR)

Voltage applied to sensor

7 to 9V dc from $1k\Omega \pm 10\%$

Input/output characteristics

Normal phase

Outputs closed if input $> 2.1mA$ ($< 2k\Omega$ in input circuit)

Outputs open if input $< 1.2mA$ ($> 10k\Omega$ in input circuit)

Hysteresis: $200\mu A$ (650Ω) nominal

Line fault detection (LFD) (when selected)

User-selectable for each channel via switches on the side of the unit. Line faults are indicated by an LED for each channel.

Open-circuit alarm on if $I_{in} < 50\mu A$

Open-circuit alarm off if $I_{in} > 250\mu A$

Short-circuit alarm on if $R_{in} < 100\Omega$

Short-circuit alarm off if $R_{in} > 360\Omega$

Note: Resistors must be fitted when using the LFD facility with a contact input
 500Ω to $1k\Omega$ in series with switch
 $20k\Omega$ to $25k\Omega$ in parallel with switch

Phase reversal

Independent for each channel, user-selectable

Safe-area outputs

Floating solid-state outputs compatible with logic circuits

Operating frequency: dc to 500Hz

Max. off-state voltage: $\pm 35V$

Max. off-state leakage current: $\pm 50\mu A$

Max. on-state resistance: 25Ω

Max. on-state current: $\pm 50mA$

MTL4513

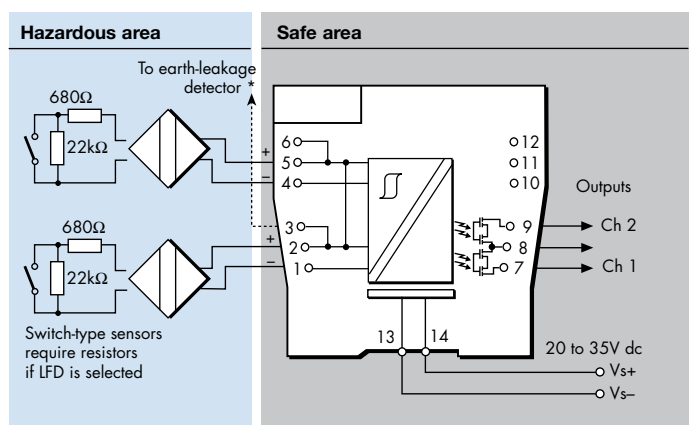

MTL5513

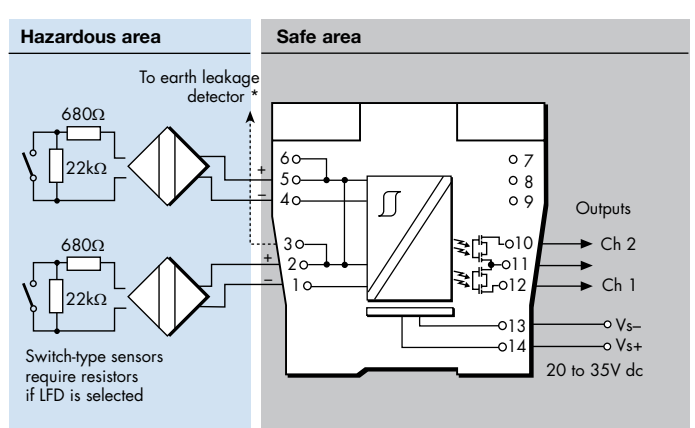

* Signal plug HAZ1-3 is required for access to this function

LED indicators

Green: power indication

Yellow: two: channel status, on when output active

Red: two: LFD indication, on when line fault detected

Maximum current consumption

30mA at 24V

Power dissipation within unit

0.65W typical at 24V, with 10mA loads

0.78W max. with 50mA loads

Safety description (each channel)

$U_o=10.5V$ $I_o=14mA$ $P_o=37mW$ $U_m=253V$ rms or dc

The given data is only intended as a product description and should not be regarded as a legal warranty of properties or guarantee. In the interest of further technical developments, we reserve the right to make design changes.



EUROPE (EMEA): +44 (0)1582 723633
 enquiry@mtl-inst.com

THE AMERICAS: +1 800 835 7075
 csinfo@mtl-inst.com

ASIA-PACIFIC: +65 6 645 9888
 sales.mtlsing@cooperindustries.com

EPSx513 Rev3 210513

MTL4514/B – MTL5514 SWITCH/ PROXIMITY DETECTOR INTERFACE

1-channel, line fault detection, phase reversal

The MTLx514 enables a safe-area load to be controlled, through a relay, by a proximity detector or switch located in a hazardous area. Line faults are signalled through a separate relay and indicated on the top of the module. Switches are provided to select phase reversal and to enable the line fault detection.

SPECIFICATION

See also common specification



Number of channels

One

Location of switch

Zone 0, IIC, T6 hazardous area
Div.1, Group A, hazardous location

Location of proximity detector

Zone 0, IIC, T4–6 hazardous area, if suitably certified
Div.1, Group A, hazardous location

Hazardous-area inputs

Inputs conforming to BS EN60947–5–6:2001 standards for proximity detectors (NAMUR)

Voltage applied to sensor

7 to 9V dc from $1k\Omega \pm 10\%$

Input/output characteristics

Normal phase

Outputs closed if input $> 2.1mA$ ($< 2k\Omega$ in input circuit)

Outputs open if input $< 1.2mA$ ($> 10k\Omega$ in input circuit)

Hysteresis: $200\mu A$ (650Ω) nominal

Line fault detection (LFD) (when selected)

User-selectable via switches on the side of the unit. Line faults are indicated by an LED. Line fault relay is energised and channel output relay de-energised if input line-fault detected

Open-circuit alarm on if $I_{in} < 50\mu A$

Open-circuit alarm off if $I_{in} > 250\mu A$

Short-circuit alarm on if $R_{in} < 100\Omega$

Short-circuit alarm off if $R_{in} > 360\Omega$

Note: Resistors must be fitted when using the LFD facility with a contact input
 500Ω to $1k\Omega$ in series with switch
 $20k\Omega$ to $25k\Omega$ in parallel with switch

Safe-area output

MTL4514 & MTL5514

Channel: Single pole relay with changeover contacts

LFD: Single pole relay with changeover contacts

MTL4514B

Channel: Single pole relay

LFD: Single pole relay

Note: reactive loads must be adequately suppressed

Relay characteristics

	MTL4514/B	MTL5514
Response time:	10ms maximum	10ms maximum
Contact rating (Safe Area):	10W, 0.5A, 35V dc	250V ac, 2A, $\cos\phi > 0.7$, 40V dc, 2A, resistive load
Contact rating (Zone 2):	10W, 0.5A, 35V dc	35V, 2A, 100VA.

MTL4514/B

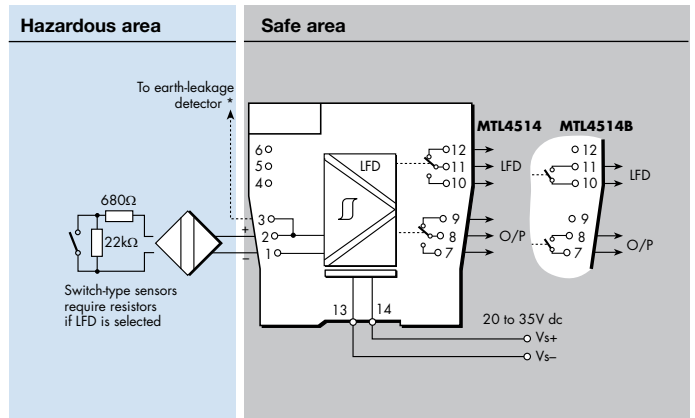

MTL5514

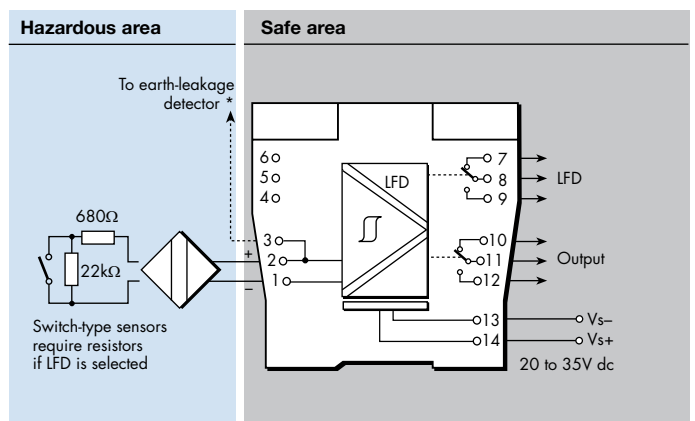

* Signal plug HAZ1-3 is required for access to this function

LED indicators

Green: power indication

Yellow: channel status, on when output energised

Red: LFD indication, on when line fault detected

Maximum current consumption

25mA at 24V dc

Power dissipation within unit

0.6W at 24V

Safety description

$U_o = 10.5V$ $I_o = 14mA$ $P_o = 37mW$ $U_m = 253V$ rms or dc



SIL capable

These models have been assessed for use in IEC 61508 functional safety applications.

See data on MTL web site and refer to the safety manual.

The given data is only intended as a product description and should not be regarded as a legal warranty of properties or guarantee. In the interest of further technical developments, we reserve the right to make design changes.



EUROPE (EMEA): +44 (0)1582 723633
enquiry@mtl-inst.com

THE AMERICAS: +1 800 835 7075
csinfo@mtl-inst.com

ASIA-PACIFIC: +65 6 645 9888
sales.mtl@cooperindustries.com

EPSx514 Rev5 220814

MTL4514D – MTL5514D

SWITCH/ PROXIMITY DETECTOR INTERFACE

1-channel, dual output, LFD, phase reversal

The MTLx514D enables two safe-area loads to be controlled, through relays, by a proximity detector or switch located in a hazardous area. When selected, open or short circuit conditions in the field wiring are detected by the line fault detect (LFD) facility and indicated on the top of the module. Switches are provided to select phase reversal and to enable the line fault detection.

SPECIFICATION

See also common specification



Number of channels

One

Location of switch

Zone 0, IIC, T6 hazardous area
Div.1, Group A, hazardous location

Location of proximity detector

Zone 0, IIC, T4–6 hazardous area, if suitably certified
Div.1, Group A, hazardous location

Hazardous-area inputs

Inputs conforming to BS EN60947–5–6:2001 standards for proximity detectors (NAMUR)

Voltage applied to sensor

7 to 9V dc from $1k\Omega \pm 10\%$

Input/output characteristics

Normal phase

Outputs closed if input $> 2.1mA$ ($< 2k\Omega$ in input circuit)

Outputs open if input $< 1.2mA$ ($> 10k\Omega$ in input circuit)

Hysteresis: $200\mu A$ (650Ω) nominal

Line fault detection (LFD) (when selected)

User-selectable via switches on the side of the unit. Line faults are indicated by an LED. The channel output relays are de-energised if an input line-fault is detected

Open-circuit alarm on if $I_{in} < 50\mu A$

Open-circuit alarm off if $I_{in} > 250\mu A$

Short-circuit alarm on if $R_{in} < 100\Omega$

Short-circuit alarm off if $R_{in} > 360\Omega$

Note: Resistors must be fitted when using the LFD facility with a contact input
 500Ω to $1k\Omega$ in series with switch
 $20k\Omega$ to $25k\Omega$ in parallel with switch

Safe-area output

MTL4514D: two, single pole relays with normally-open contacts

MTL5514D: two, single pole relays with changeover contacts

Note: reactive loads must be adequately suppressed

Relay characteristics

	MTL4514D	MTL5514D
Response time:	10ms maximum	10ms maximum
Contact rating (Safe Area):	10W, 0.5A, 35V dc	250V ac, 2A, $\cos\phi > 0.7$, 40V dc, 2A, resistive load
Contact rating (Zone 2):	10W, 0.5A, 35V dc	35V, 2A, 100VA.

MTL4514D

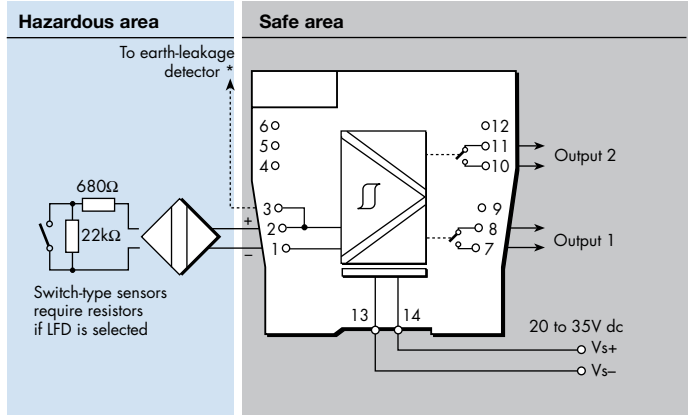

MTL5514D

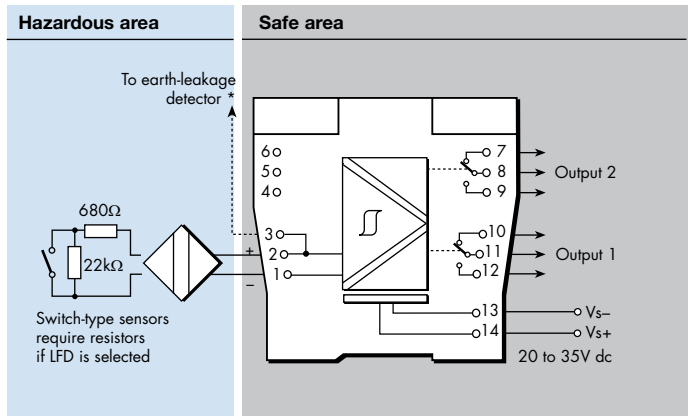

* Signal plug HAZ1-3 is required for access to this function

LED indicators

Green: power indication

Yellow: channel status, on when output energised

Red: LFD indication, on when line fault detected

Maximum current consumption

29mA at 24V dc

Power dissipation within unit

0.7W at 24V

Safety description (Certification pending)

$U_o=10.5V$ $I_o=14mA$ $P_o=37mW$ $U_m = 253V$ rms or dc



SIL capable

These models have been assessed for use in IEC 61508 functional safety applications.

See data on MTL web site and refer to the safety manual.

The given data is only intended as a product description and should not be regarded as a legal warranty of properties or guarantee. In the interest of further technical developments, we reserve the right to make design changes.



EUROPE (EMEA): +44 (0)1582 723633
enquiry@mtl-inst.com

THE AMERICAS: +1 800 835 7075
csinfo@mtl-inst.com

ASIA-PACIFIC: +65 6 645 9888
sales.mtlsing@cooperindustries.com

EPSx514D 251013

MTL4516/C – MTL5516C

SWITCH/ PROXIMITY DETECTOR INTERFACE

2-channel, with line fault detection

The MTLx516/C enable two safe-area loads to be controlled by a switch or proximity detector located in a hazardous-area. When selected, open or short circuit conditions in the field wiring are detected by the line-fault-detect (LFD) facility and also indicated on the top of the module. Phase reversal for each channel is selected by a switch on the side of the module and output is provided by changeover relay contacts.

SPECIFICATION

See also common specification



Number of channels

Two

Location of switches

Zone 0, IIC, T6 hazardous area
Div. 1, Group A hazardous location

Location of proximity detector

Zone 0, IIC, T4–6 hazardous area if suitably certified
Div. 1, Group A hazardous location

Hazardous-area inputs

Inputs conforming to BS EN60947–5–6:2001 standards for proximity detectors (NAMUR)

Voltage applied to sensor

7 to 9V dc from $1k\Omega \pm 10\%$

Input/output characteristics

Normal phase

Outputs closed if input $> 2.1mA$ ($< 2k\Omega$ in input circuit)

Outputs open if input $< 1.2mA$ ($> 10k\Omega$ in input circuit)

Hysteresis: $200\mu A$ (650Ω) nominal

Line fault detection (LFD) (when selected)

User-selectable via switches on the side of the unit. Line faults are indicated by an LED for each channel. The channel output relay is de-energised if an input line fault is detected.

Open-circuit alarm on if $I_{in} < 50\mu A$

Open-circuit alarm off if $I_{in} > 250\mu A$

Short-circuit alarm on if $R_{in} < 100\Omega$

Short-circuit alarm off if $R_{in} > 360\Omega$

Note: Resistors must be fitted when using the LFD facility with a contact input
 500Ω to $1k\Omega$ in series with switch
 $20k\Omega$ to $25k\Omega$ in parallel with switch

Safe-area output

Two single-pole relays with changeover contacts

Note: reactive loads must be adequately suppressed

Relay characteristics

	MTL4516/C	MTL5516C
Response time:	10ms maximum	10ms maximum
Contact rating (Safe Area):	10W, 0.5A, 35V dc	250V ac, 2A, $\cos\phi > 0.7$, 40V dc, 2A, resistive load
Contact rating (Zone 2):	10W, 0.5A, 35V dc	35V, 2A, 100VA.

Maximum current consumption

35mA at 24V

Power dissipation within unit

0.84W at 24V

MTL4516

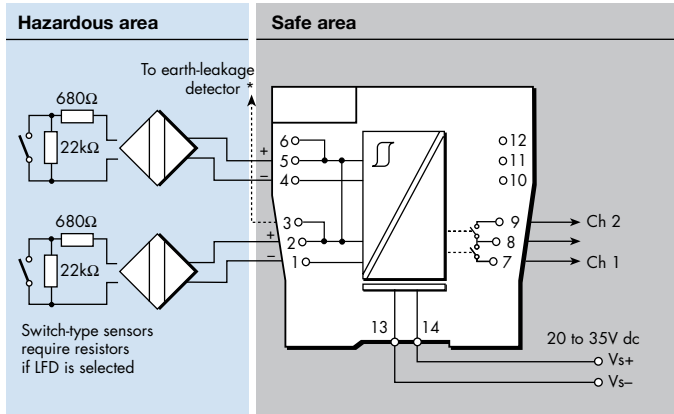

MTL4516C

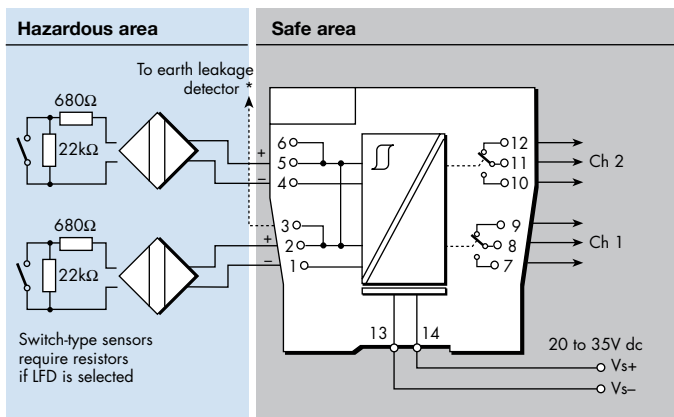

MTL5516C

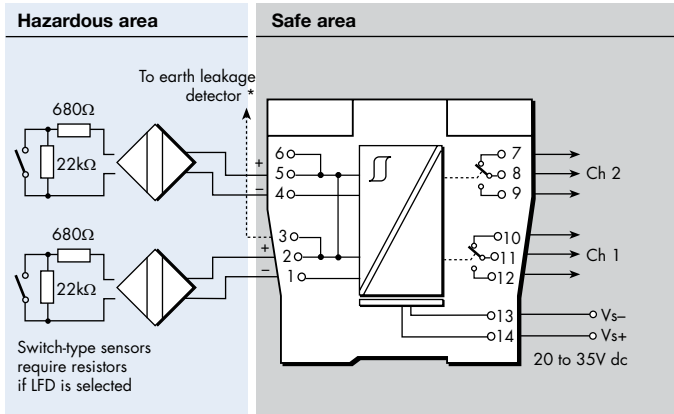

* Signal plug HAZ1-3 is required for access to this function

LED indicators

Green: power indication

Yellow: two: channel status, on when output energised

Red: two: LFD indication, on when line fault detected

Safety description (each channel)

$U_o=10.5V$ $I_o=14mA$ $P_o=37mW$ $U_m=253V$ rms or dc



SIL capable

These models have been assessed for use in IEC 61508 functional safety applications. See data on MTL web site and refer to the safety manual.

The given data is only intended as a product description and should not be regarded as a legal warranty of properties or guarantee. In the interest of further technical developments, we reserve the right to make design changes.



EUROPE (EMEA): +44 (0)1582 723633
enquiry@mtl-inst.com

THE AMERICAS: +1 800 835 7075
csinfo@mtl-inst.com

ASIA-PACIFIC: +65 6 645 9888
sales.mtl@cooperindustries.com

EPSx516/C Rev4 200913

MTL4517 – MTL5517 SWITCH/ PROXIMITY DETECTOR INTERFACE

2-channel, line fault detection, phase reversal

The MTLx517 enables two safe-area loads to be controlled, through a relay, by proximity detectors or switches located in a hazardous area. Line faults are signalled through a separate relay and indicated on the top of the module. Switches are provided to select phase reversal and to enable the line fault detection.

SPECIFICATION

See also common specification



Number of channels

Two

Location of switch

Zone 0, IIC, T6 hazardous area
Div.1, Group A, hazardous location

Location of proximity detector

Zone 0, IIC, T4–6 hazardous area, if suitably certified
Div.1, Group A, hazardous location

Hazardous-area inputs

Inputs conforming to BS EN60947–5–6:2001 standards for proximity detectors (NAMUR)

Voltage applied to sensor

7 to 9V dc from $1k\Omega \pm 10\%$

Input/output characteristics

Normal phase

Outputs closed if input $> 2.1mA$ ($< 2k\Omega$ in input circuit)

Outputs open if input $< 1.2mA$ ($> 10k\Omega$ in input circuit)

Hysteresis: $200\mu A$ (650Ω) nominal

Line fault detection (LFD) (when selected)

User selectable by switches on the side of the module.

Line faults are indicated by the LED for each channel.

Line fault relay is energised and channel output relay de-energised if input line-fault detected

Open-circuit alarm on if $I_{in} < 50\mu A$

Open-circuit alarm off if $I_{in} > 250\mu A$

Short-circuit alarm on if $R_{in} < 100\Omega$

Short-circuit alarm off if $R_{in} > 360\Omega$

Note: Resistors must be fitted when using the LFD facility with a contact input

500Ω to $1k\Omega$ in series with switch

$20k\Omega$ to $25k\Omega$ in parallel with switch

Safe-area output

Channel: Two single-pole relays with normally open contacts

LFD: Single pole relay with changeover contacts

Note: reactive loads must be adequately suppressed

Relay characteristics

	MTL4517	MTL5517
Response time:	10ms maximum	10ms maximum
Contact rating (Safe Area):	10W, 0.5A, 35V dc	250V ac, 2A, $\cos\phi > 0.7$, 40V dc, 2A, resistive load
Contact rating (Zone 2):	10W, 0.5A, 35V dc	35V, 2A, 100VA.

Maximum current consumption

35mA at 24V

Power dissipation within unit

0.84W at 24V

MTL4517

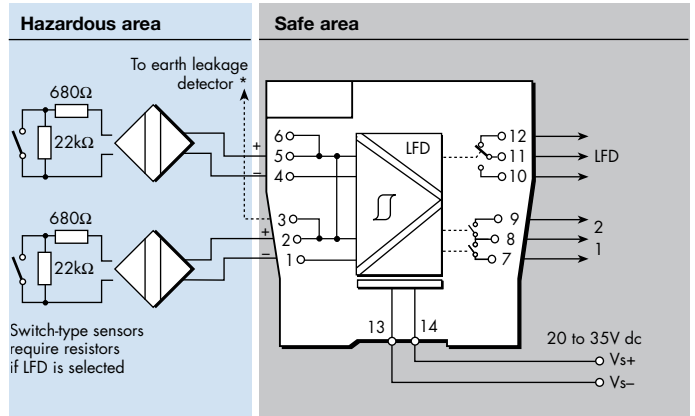

MTL5517

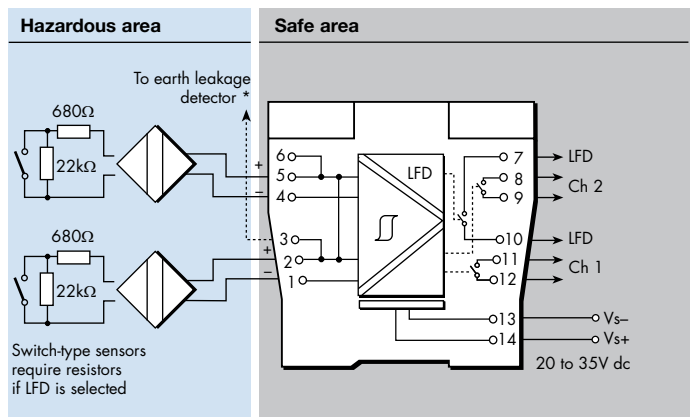

* Signal plug HAZ1-3 is required for access to this function

LED indicators

Green: power indication

Yellow: two: channel status, on when output energised

Red: two: LFD indication, on when line fault detected

Safety description (each channel)

$U_o=10.5V$ $I_o=14mA$ $P_o=37mW$ $U_m=253V$ rms or dc



SIL capable

These models have been assessed for use in IEC 61508 functional safety applications.

See data on MTL web site and refer to the safety manual.

The given data is only intended as a product description and should not be regarded as a legal warranty of properties or guarantee. In the interest of further technical developments, we reserve the right to make design changes.



EUROPE (EMEA): +44 (0)1582 723633
enquiry@mtl-inst.com

THE AMERICAS: +1 800 835 7075
csinfo@mtl-inst.com

ASIA-PACIFIC: +65 6 645 9888
sales.mtl@cooperindustries.com

EPSx517 Rev4 200913

MTL4521/L – MTL5521

SOLENOID/ ALARM DRIVER

loop-powered, IIC

The MTLx521 and the MTL4521L are loop-powered modules which enable a device located in the hazardous area to be controlled from the safe area. They can all drive a certified intrinsically safe low-power load, as well as non-energy-storing simple apparatus such as an LED.

SPECIFICATION

See also common specification



Number of channels

One

Location of load

Zone 0, IIC, T4--6 hazardous area if suitably certified
Div. 1, Group A hazardous location

Minimum output voltage Equivalent output circuit (MTLx521)

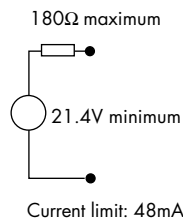
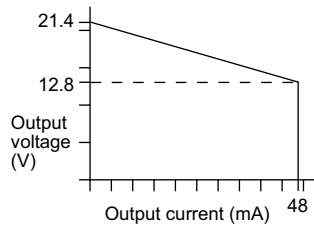

Minimum output voltage Equivalent output circuit (MTL4521L)

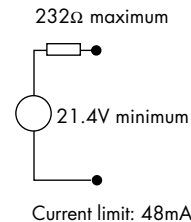
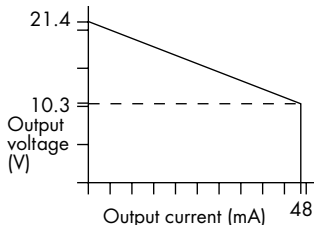

Input voltage

20 to 35V dc

Hazardous-area output (MTLx521)

Minimum output voltage: 12.8V at 48mA
Maximum output voltage: 24V from 180Ω
Current limit: 48mA

Hazardous-area output (MTL4521L)

Minimum output voltage: 10.3V at 48mA
Maximum output voltage: 24V from 232Ω
Current limit: 48mA

Output ripple

< 0.5% of maximum output, peak to peak

Response time

Output within 10% of final value within 100ms

MTL4521 / MTL4521L

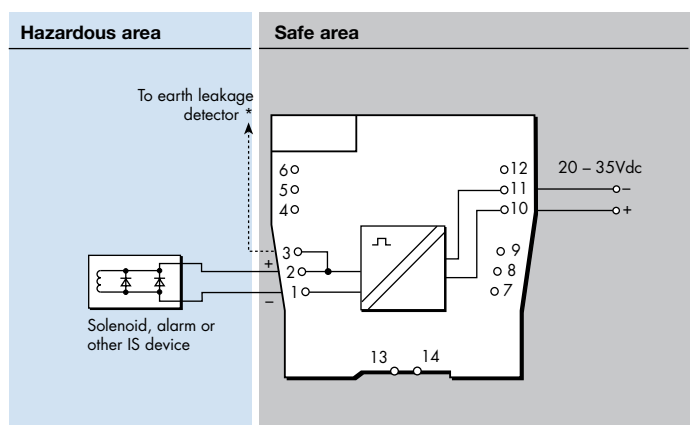

MTL5521

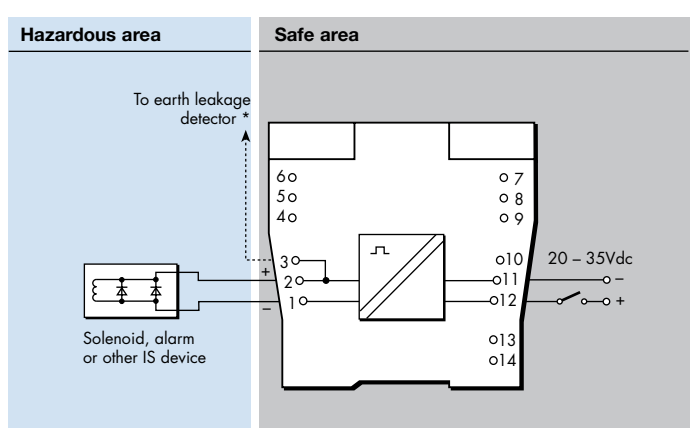

* Signal plug HAZ1-3 is required for access to this function

LED indicator

Yellow: output status, on when output active

Maximum current consumption

90mA at 24V

Power dissipation within unit

1.4W at 24V

Safety description (MTLx521)

$U_o=25V$ $I_o=147mA$ $P_o=0.92W$ $U_m=253V$ rms or dc

Safety description (MTL4521L)

$U_o=25V$ $I_o=108mA$ $P_o=0.68W$ $U_m=253V$ rms or dc



SIL capable

These models have been assessed for use in IEC 61508 functional safety applications. See data on MTL web site and refer to the safety manual.

The given data is only intended as a product description and should not be regarded as a legal warranty of properties or guarantee. In the interest of further technical developments, we reserve the right to make design changes.



EUROPE (EMEA): +44 (0)1582 723633
enquiry@mtl-inst.com

THE AMERICAS: +1 800 835 7075
csinfo@mtl-inst.com

ASIA-PACIFIC: +65 6 645 9888
sales.mtlsing@cooperindustries.com

EPSx521 Rev4 200913

MTL5522

SOLENOID/ALARM DRIVER

loop-powered, IIB

The MTL5522 is a loop-powered module which enables a device located in the hazardous area to be controlled from the safe area. The MTL5522 can drive a certified intrinsically safe low-power load, as well as non-energy-storing simple apparatus such as an LED. The unit's input/output isolation allows the control switch to be connected into either side of the 24V dc supply circuit.

SPECIFICATION

See also common specification

Number of channels

One

Location of load

Zone 0, IIB, T4-6 hazardous area if suitably certified
Div. 1, Group C hazardous location

Minimum output voltage

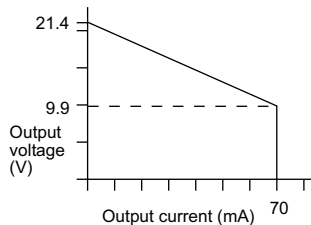

Equivalent output circuit

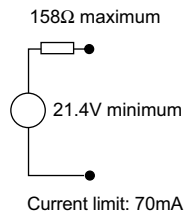

Input voltage

20 to 35V dc

Hazardous-area output

Minimum output voltage: 9.9V at 70mA
Maximum output voltage: 24V from 158Ω
Current limit: 70mA

Output ripple

< 0.5% of maximum output, peak to peak

Response time

Output within 10% of final value within 100ms



MTL5522

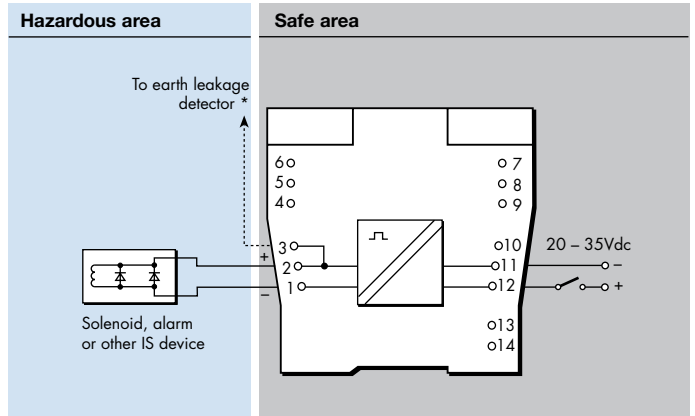

* Signal plug HAZ1-3 is required for access to this function

LED indicator

Yellow: output status, on when output active

Maximum current consumption

125mA (typ.) at 24V

Power dissipation within unit

1.4W at 24V

Safety description

$U_o=25V$ $I_o=166mA$ $P_o=1.04W$ $U_m=253V$ rms or dc



SIL capable

These models have been assessed for use in IEC 61508 functional safety applications. See data on MTL web site and refer to the safety manual.

The given data is only intended as a product description and should not be regarded as a legal warranty of properties or guarantee. In the interest of further technical developments, we reserve the right to make design changes.



EUROPE (EMEA): +44 (0)1582 723633
enquiry@mtl-inst.com

THE AMERICAS: +1 800 835 7075
csinfo@mtl-inst.com

ASIA-PACIFIC: +65 6 645 9888
sales.mtlsing@cooperindustries.com

EPSx522 Rev4 200913

MTL4523/R – MTL5523

SOLENOID/ALARM DRIVER

with line fault detection, IIC

With the MTLx523 interface, an on/off device in a hazardous area can be controlled by a volt-free contact or logic signal in the safe area. It is suitable for driving loads such as solenoids. Line fault detection (LFD), which operates irrespective of the output state, is signalled by a safe-area solid-state switch which de-energises MTLx523, or energises MTL4523R, if a field line is open or short-circuited. Earth fault detection can be provided by connecting an MTL4220 earth leakage detector to terminal 3.

SPECIFICATION

See also common specification



Number of channels

One

Location of load

Zone 0, IIC, T4–6 hazardous area if suitably certified
Div. 1, Group A, hazardous location

Minimum output voltage

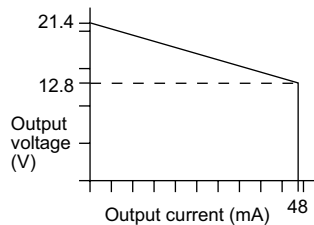

Equivalent output circuit

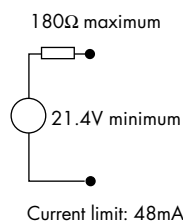

Hazardous-area output

Minimum output voltage: 12.8V at 48mA
Maximum output voltage: 24V from 180Ω
Maximum off-state output voltage: 4V from 180Ω
Current limit: 48mA

Output ripple

< 0.5% of maximum output, peak to peak

Control input

Suitable for switch contacts, an open collector transistor or logic drive.
(Internal contact wetting voltage 12V @ 0.2mA contact closed.
Not suitable for voltage control via series diode.)

Output turns on if input switch closed, transistor on or < 1.4V applied across control input
Output turns off if input switch open, transistor off or > 4.5V applied across control input

Response time

Output within 10% of final value within 100ms

Line fault detection (LFD)

Open or short circuit in field cabling *de-energises** solid state line-fault signal.

LFD transistor is switched *on**, provided that the field circuit impedance is > 55Ω and < 4kΩ.

* These conditions are reversed for the MTL4523R. This is to permit parallel connection of alarms between modules to provide a group alarm output.

Line fault signal characteristics

Maximum off-state voltage: 35V
Maximum off-state leakage current: 10μA
Maximum on-state voltage drop: 2V
Maximum on-state current: 50mA

MTL4523 / MTL4523R

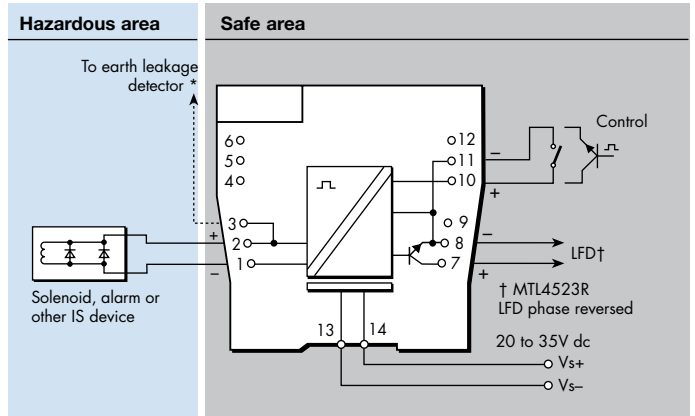

MTL5523

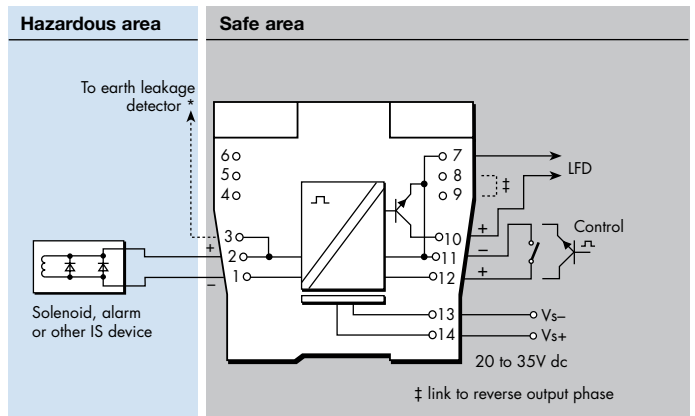

* Signal plug HAZ1-3 is required for access to this function

LED indicators

Green: power indication
Yellow: output status, on when output active
Red: LFD indication, on when line fault detected

Maximum current consumption

100mA at 24V dc

Power dissipation within unit

1.2W with typical solenoid valve, output on
2.0W worst case

Safety description

$U_o=25V$ $I_o=147mA$ $P_o=0.92W$ $U_m=253V$ rms or dc



SIL capable

These models have been assessed for use in IEC 61508 functional safety applications. See data on MTL web site and refer to the safety manual.

The given data is only intended as a product description and should not be regarded as a legal warranty of properties or guarantee. In the interest of further technical developments, we reserve the right to make design changes.



EUROPE (EMEA): +44 (0)1582 723633
enquiry@mtl-inst.com

THE AMERICAS: +1 800 835 7075
csinfo@mtl-inst.com

ASIA-PACIFIC: +65 6 645 9888
sales.mtlsing@cooperindustries.com

EPSx523/R Rev5 200913

MTL4523L

SOLENOID/ ALARM DRIVER

loop-powered with line fault detection, IIC

With the MTL4523L interface, an on/off device in a hazardous area can be controlled by a voltage signal in the safe area. It is suitable for driving loads such as solenoids. Line fault detection (LFD), which operates when the output is energised, is signalled by a safe-area solid-state switch which energises if a field line is open or short-circuited. Earth fault detection can be provided by connecting an MTL4220 earth leakage detector to terminal 3.

SPECIFICATION

See also common specification

Number of channels

One

Location of load

Zone 0, IIC, T4-6 hazardous area if suitably certified
Div. 1, Group A, hazardous location

Minimum output voltage Equivalent output circuit

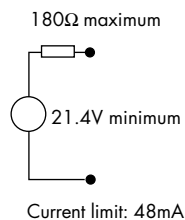
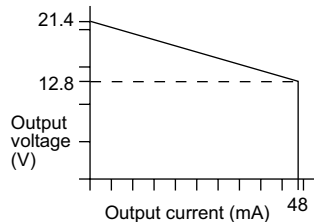

Input voltage

20 to 35V dc

Hazardous-area output

Minimum output voltage: 12.8V at 48mA
Maximum output voltage: 24V from 180Ω
Current limit: 48mA

Output ripple

< 0.5% of maximum output, peak to peak

Response time

Output within 10% of final value within 100ms

Line fault detection (LFD)

Open or short circuit in field cabling energises solid state line fault signal

LFD transistor is switched on, provided that the field circuit impedance is > 55Ω and < 4kΩ.

Line fault signal characteristics

Maximum off-state voltage: 35V
Maximum off-state leakage current: 10μA
Maximum on-state voltage drop: 2V
Maximum on-state current: 50mA

Note: LFD signal is Zener-diode protected against inductive loads

* Signal plug HAZ1-3 is required for access to this function

MTL4523L

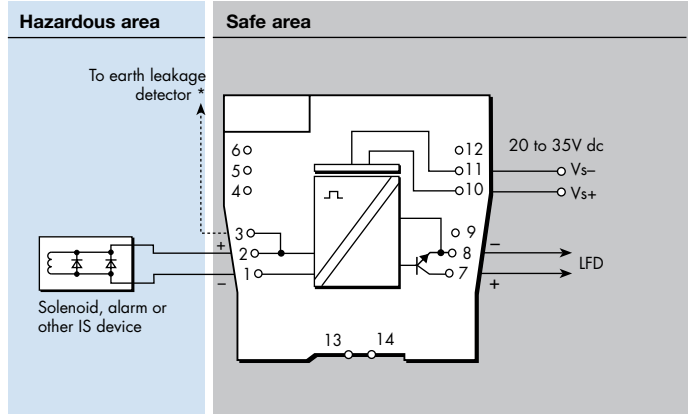

LED indicators

Yellow: output status, on when output active

Red: LFD indication, on when line fault detected

Maximum current consumption

100mA at 24V dc

Power dissipation within unit

1.2W with typical solenoid valve, output on

Safety description

$U_o=25V$ $I_o=147mA$ $P_o=0.92W$ $U_m=253V$ rms or dc



SIL capable

These models have been assessed for use in IEC 61508 functional safety applications.

See data on MTL web site and refer to the safety manual.

The given data is only intended as a product description and should not be regarded as a legal warranty of properties or guarantee. In the interest of further technical developments, we reserve the right to make design changes.



EUROPE (EMEA): +44 (0)1582 723633
enquiry@mtl-inst.com

THE AMERICAS: +1 800 835 7075
csinfo@mtl-inst.com

ASIA-PACIFIC: +65 6 645 9888
sales.mtlsing@cooperindustries.com

EPS4523L Rev 6 241014

MTL4523V/VL – MTL5523V/VL

SOLENOID/ALARM DRIVER

with line fault detection, IIC

With the MTLx523V/VL interface, an on/off device in a hazardous area can be controlled by a voltage signal in the safe area. It is suitable for driving loads such as solenoids. Line fault detection (LFD), which operates irrespective of the output state, is signalled by a safe-area solid-state switch which energises if a field line is open or short-circuited. Earth fault detection can be provided by connecting an MTL4220 earth leakage detector to terminal 3.

SPECIFICATION

See also common specification



Number of channels

One

Location of load

Zone 0, IIC, T4–6 hazardous area if suitably certified
Div. 1, Group A, hazardous location

Minimum output voltage (MTLx523V)

Equivalent output circuit

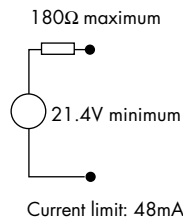
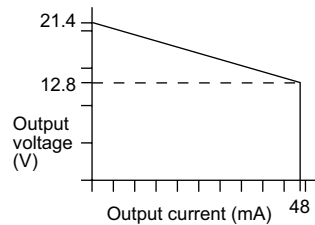

Minimum output voltage (MTLx523VL)

Equivalent output circuit

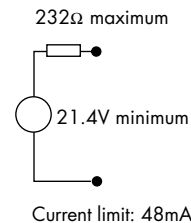
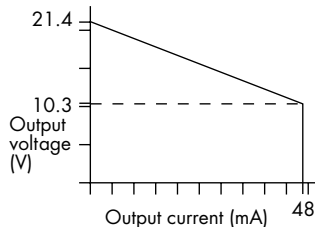

Hazardous-area output (MTLx523V)

Minimum output voltage: 12.8V at 48mA
Maximum output voltage: 24V from 180Ω
Maximum off-state output voltage: 4V from 180Ω
Current limit: 48mA

Hazardous-area output (MTLx523VL)

Minimum output voltage: 10.3V at 48mA
Maximum output voltage: 24V from 232Ω
Maximum off-state output voltage: 4V from 232Ω
Current limit: 48mA

Output ripple

< 0.5% of maximum output, peak to peak

Control input

Suitable for 24V logic drive
Output turns on if > 18V applied across control input
Output turns off if < 5V applied across control input
Maximum control input voltage: 28V
Maximum control system output leakage current: 0.5mA

Response time

Output within 10% of final value within 100ms

MTL4523V/MTL4523VL

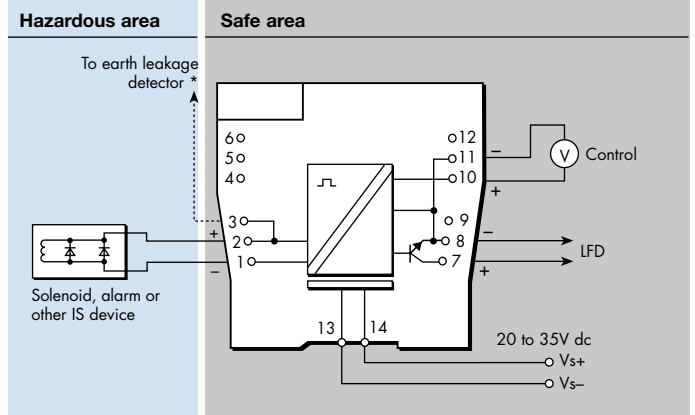

MTL5523V/MTL5523VL

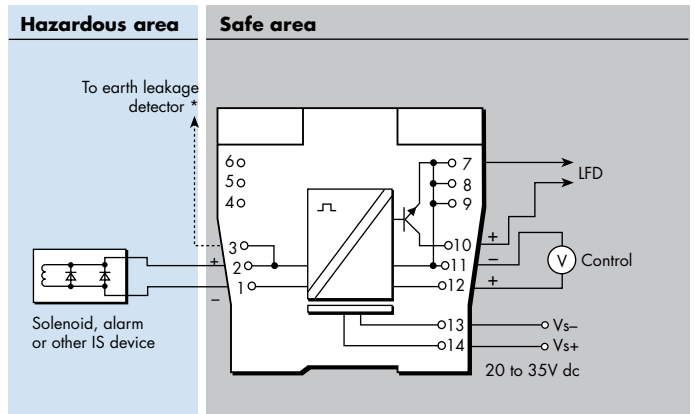

*Signal plug HAZ1-3 is required for access to this function

Line fault detection (LFD)

Open or short circuit in field cabling energises solid state line-fault signal.
LFD transistor is switched off, provided that the field circuit impedance is > 55Ω and < 4kΩ.

Line fault signal characteristics

Maximum off-state voltage: 35V
Maximum off-state leakage current: 10μA
Maximum on-state voltage drop: 2V
Maximum on-state current: 50mA

LED indicators

Green: power indication
Yellow: output status, on when output active
Red: LFD indication, on when line fault detected

Maximum current consumption

100mA at 24V dc

Power dissipation within unit

1.2W with typical solenoid valve, output on
2.0W worst case

Safety description (MTLx523V)

$V_o=25V$ $I_o=147mA$ $P_o=0.92W$ $U_m=253V$ rms or dc

Safety description (MTLx523VL)

$V_o=25V$ $I_o=108mA$ $P_o=0.68W$ $U_m=253V$ rms or dc



SIL capable

These models have been assessed for use in IEC 61508 functional safety applications.
See data on MTL web site and refer to the safety manual.

The given data is only intended as a product description and should not be regarded as a legal warranty of properties or guarantee. In the interest of further technical developments, we reserve the right to make design changes.



EUROPE (EMEA): +44 (0)1582 723633
enquiry@mtl-inst.com

THE AMERICAS: +1 800 835 7075
csinfo@mtl-inst.com

ASIA-PACIFIC: +65 6 645 9888
sales.mtl@cooperindustries.com

EPSx523V-VL Rev2 200913

MTL4524 – MTL5524

SOLENOID/ALARM DRIVER

switch operated with override, IIC

The MTLx524 enables an on/off device in a hazardous area to be controlled by a volt-free contact or logic signal in the safe area. It can drive loads such as solenoids, alarms, LEDs and other low power devices that are certified as intrinsically safe or are classified as non-energy storing simple apparatus.

The MTL4524 allows a second safe-area switch or logic signal to be connected enabling the output to be disabled to permit, for example, a safety system to override a control signal.

The MTL5524 has its phase reversed by connecting a wire link between pins 8 and 9.

SPECIFICATION

See also common specification



Number of channels

One

Location of load

Zone 0, IIC, T4–6 hazardous area if suitably certified
Div.1, Group A, hazardous location

Minimum output voltage Equivalent output circuit

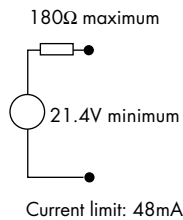
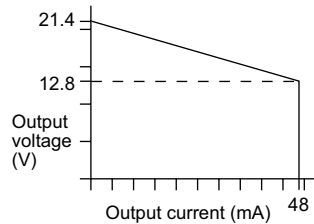

Hazardous-area output

Hazardous-area output

Minimum output voltage: 12.8V at 48mA
Maximum output voltage: 24V from 180Ω
Maximum off-state output voltage: 4V from 180Ω
Current limit: 48mA

Output ripple

< 0.5% of maximum output, peak-to-peak

Control input

Suitable for switch contacts, an open collector transistor or logic drive

0 = input switch closed, transistor on or <1.4V applied

1 = input switch open, transistor off or >4.5V applied

Override input on MTL4524

An open collector transistor or a switch connected across the terminals can be used to turn the output off whatever the state of the control input

0 = transistor on or switch closed

1 = transistor off or switch open

Control and override inputs on MTL4524

Control input	Override input	Output state
0	0	off
0	1	on
1	0	off
1	1	off

Response time

Output within 10% of final value within 100ms

MTL4524

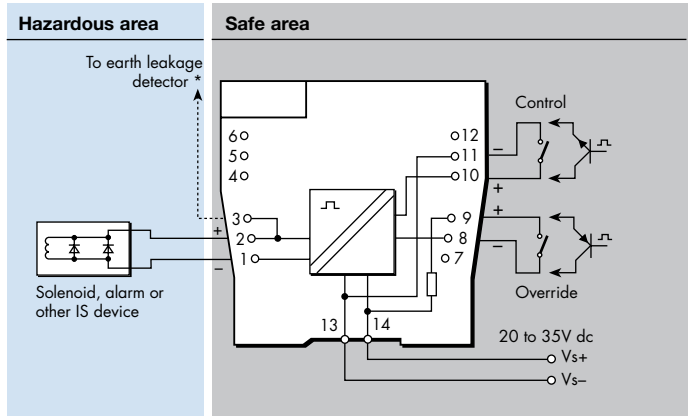

MTL5524

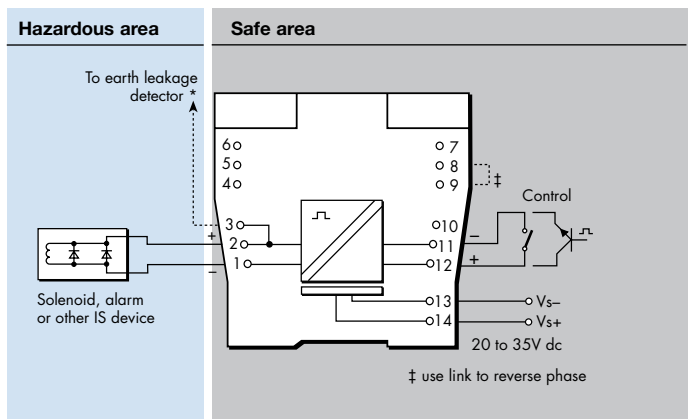

* Signal plug HAZ1-3 is required for access to this function

LED indicators

Green: power indication

Yellow: output status, on when output active

Maximum current consumption

100mA at 24V dc

Power dissipation within unit

1.3W with typical solenoid valve, output on
1.9W worst case

Safety description

$U_o=25V$ $I_o=147mA$ $P_o=0.92W$ $U_m=253V$ rms or dc



SIL capable

These models have been assessed for use in IEC 61508 functional safety applications.

See data on MTL web site and refer to the safety manual.

The given data is only intended as a product description and should not be regarded as a legal warranty of properties or guarantee. In the interest of further technical developments, we reserve the right to make design changes.



EUROPE (EMEA): +44 (0)1582 723633
enquiry@mtl-inst.com

THE AMERICAS: +1 800 835 7075
csinfo@mtl-inst.com

ASIA-PACIFIC: +65 6 645 9888
sales.mtl@cooperindustries.com

EPSx524 Rev4 200913

MTL4524S

SOLENOID/ALARM DRIVER

switch operated with 24V override, IIC

The MTL4524S enables an on/off device in a hazardous area to be controlled by a volt-free contact or a floating logic signal in the safe area. It can drive loads such as solenoids, alarms, LEDs and other low power devices that are certified as intrinsically safe or are classified as non-energy storing simple apparatus. By connecting a second safe-area voltage, the output can be disabled to permit, for example, a safety system to override a control signal.

SPECIFICATION

See also common specification



Number of channels

One

Location of load

Zone 0, IIC, T4-6 hazardous area if suitably certified
Div.1, Group A, hazardous location

Minimum output voltage Equivalent output circuit

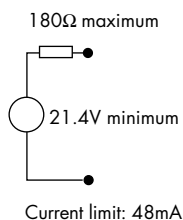
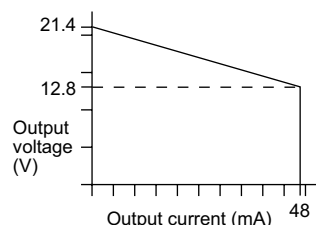

Hazardous-area output

Minimum output voltage: 12.8V at 48mA
Maximum output voltage: 24V from 180Ω
Maximum off-state output voltage: 4V from 180Ω
Current limit: 48mA

Output ripple

< 0.5% of maximum output, peak-to-peak

Control input (must be fully-floating)

Suitable for switch contacts or an opto-isolator

0 = input switch closed, transistor on or < 1.4V applied

1 = input switch open, transistor off or > 4.5V applied

Override input

A 24V logic signal applied across the terminals allows the solenoid/alarm to be operated by the control input. If it is disconnected, the solenoid/alarm is off.

0 = < 2.0V applied across terminals 8 & 9

1 = > 9.0V applied across terminals 8 & 9

(nominal switching point 4.5V)

Control and override inputs

Control input	Override input	Output state
0	0	off
0	1	on
1	0	off
1	1	off

Response time

Output within 10% of final value within 100ms

MTL4524S

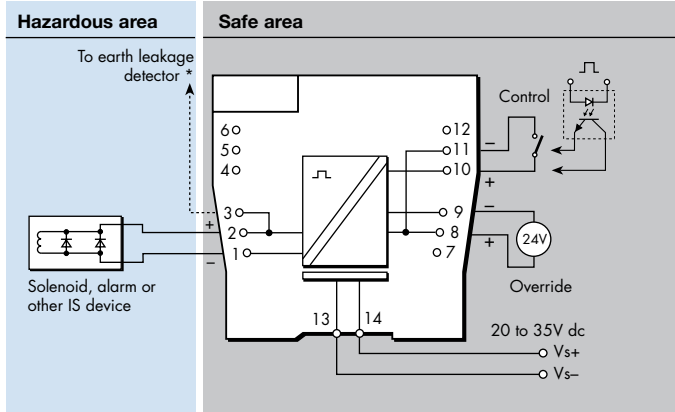

* Signal plug HAZ1-3 is required for access to this function

LED indicators

Green: power indication

Yellow: output status, on when output active

Maximum current consumption

100mA at 24V dc

Power dissipation within unit

1.3W with typical solenoid valve, output on

1.9W worst case

Safety description

$U_o=25V$ $I_o=147mA$ $P_o=0.92W$ $U_m=253V$ rms or dc



SIL capable

These models have been assessed for use in IEC 61508 functional safety applications.

See data on MTL web site and refer to the safety manual.

The given data is only intended as a product description and should not be regarded as a legal warranty of properties or guarantee. In the interest of further technical developments, we reserve the right to make design changes.



EUROPE (EMEA): +44 (0)1582 723633
enquiry@mtl-inst.com

THE AMERICAS: +1 800 835 7075
csinfo@mtl-inst.com

ASIA-PACIFIC: +65 6 645 9888
sales.mtl@cooperindustries.com

EPS4524S Rev4 200913

MTL4525 – MTL5525

SOLENOID/ALARM DRIVER

switch operated with override, IIC, low power

The MTLx525 enables an on/off device in a hazardous area to be controlled by a volt-free contact or logic signal in the safe area. It can drive loads such as solenoids, alarms, LEDs and other low power devices that are certified as intrinsically safe or are classified as non-energy storing simple apparatus.

The MTL4525 allows a second safe-area switch or logic signal to be connected that enables the output to be disabled to permit, for example, a safety system to override a control signal.

SPECIFICATION

See also common specification



Number of channels

One

Location of load

Zone 0, IIC, T4–6 hazardous area if suitably certified
Div.1, Group A, hazardous location

Minimum output voltage Equivalent output circuit

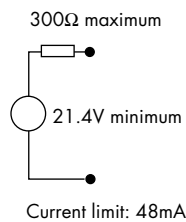
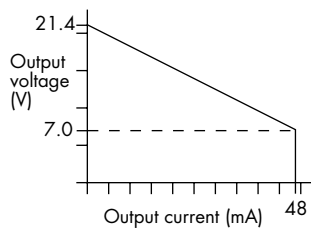

Hazardous-area output

Hazardous-area output

Minimum output voltage: 7V at 48mA
Maximum output voltage: 24V from 300Ω
Maximum off-state output voltage: 4V from 300Ω
Current limit: 48mA

Output ripple

< 0.5% of maximum output, peak-to-peak

Control input on MTL4525

Suitable for switch contacts, an open collector transistor or logic drive

0 = input switch closed, transistor on or < 1.4V applied

1 = input switch open, transistor off or > 4.5V applied

Override input on MTL4525

An open collector transistor or a switch connected across the terminals can be used to turn the output off whatever the state of the control input

0 = transistor on or switch closed

1 = transistor off or switch open

Control and override inputs on MTL4525

Control input	Override input	Output state
0	0	off
0	1	on
1	0	off
1	1	off

Response time

Output within 10% of final value within 100ms

MTL4525

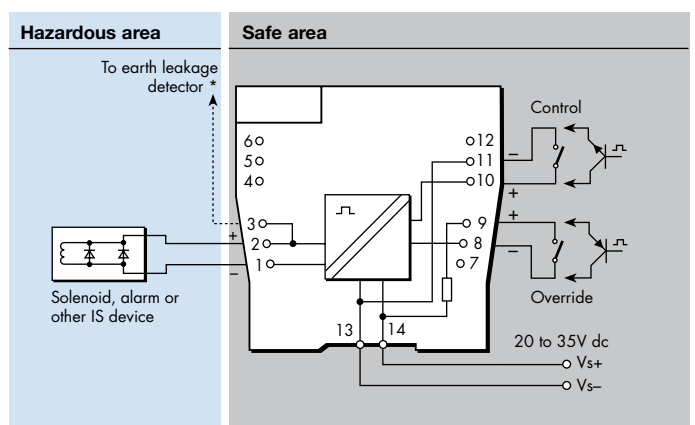

MTL5525

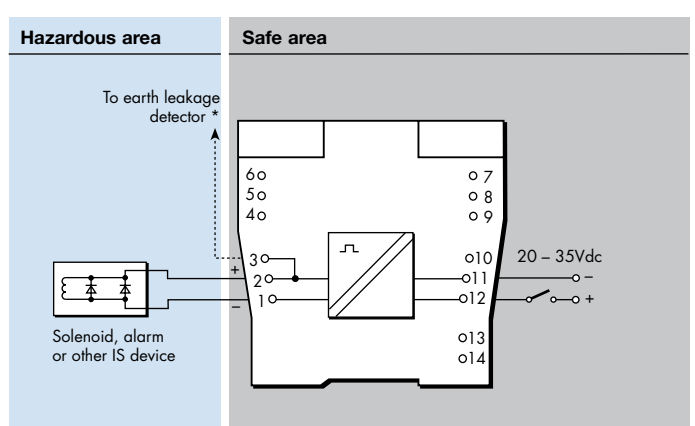

* Signal plug HAZ1-3 is required for access to this function

LED indicators

Green: power indication

Yellow: output status, on when output active

Maximum current consumption

100mA at 24V dc

Power dissipation within unit

1.3W with typical solenoid valve, output on

1.9W worst case

Safety description

$U_o=25V$ $I_o=83.3mA$ $P_o=0.52W$ $U_m = 253V$ rms or dc



SIL capable

These models have been assessed for use in IEC 61508 functional safety applications.

See data on MTL web site and refer to the safety manual.

The given data is only intended as a product description and should not be regarded as a legal warranty of properties or guarantee. In the interest of further technical developments, we reserve the right to make design changes.



EUROPE (EMEA): +44 (0)1582 723633
enquiry@mtl-inst.com

THE AMERICAS: +1 800 835 7075
csinfo@mtl-inst.com

ASIA-PACIFIC: +65 6 645 9888
sales.mtlsing@cooperindustries.com

EPSx525 Rev4 200913

MTL4526 – MTL5526

SWITCH-OPERATED RELAY

2-channel IS-output

The MTL4526 enables two separate IS circuits in a hazardous area to be contact controlled by one or two, on/off, control signals in a safe area. Applications include the calibration of strain-gauge bridges; changing the polarity (and thereby the tone) of an IS sounder; the testing of IS fire alarms; and the transfer of safe-area signals into an annunciator with IS input terminals not segregated from each other. The output-relay contacts are certified as non-energy-storing apparatus, and can be connected to any IS circuit without further certification, provided that separate IS circuits are such that they would remain safe if connected together.

SPECIFICATION

See also common specification

Number of channels

Two, fully floating

Location of control circuit

Safe area

Input/output characteristics

Contact/Logic mode

(Inputs suitable for switch contacts, an open-collector transistor or logic drive)

Relay energised if < 450Ω or < 1V applied

Relay de-energised if > 5kΩ or > 2V applied (35V max.)

Loop powered mode

Relay energised if >20V

Relay de-energised if <17V

Power supply failure protection

Relays de-energised if supply fails

Response time

25ms nominal

Contacts (suitable for connection to IS circuits)

1-pole changeover per channel

Contact rating

250V dc, limited to 30V dc for IS applications, 2A (reactive loads must be suppressed)

Contact life expectancy

2 x 10⁷ operations at maximum IS load

Relay drive (see switch setting table)

Choice of "loop-powered" or "contact/logic" control, for both channels, by switch selection. A further switch option ("1in2out") enables either input, in contact/logic mode, to activate both outputs.

MTL4526

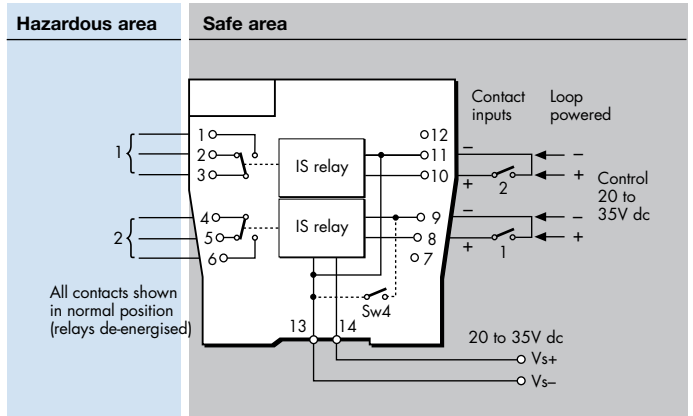

MTL5526

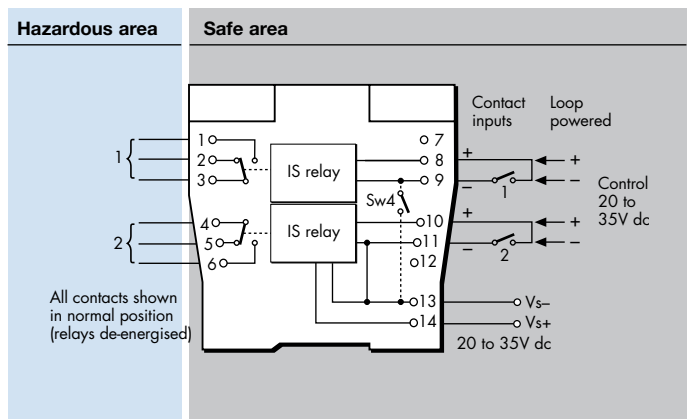

LED indicators

Green: power indication

Yellow: two: output status, on when relay energised

Power requirement, V_s

41mA at 20V dc

44mA at 24V dc

60mA at 35V dc

Power dissipation within unit

1.1W maximum at 24V

Safety description (each channel)

Non-energy-storing apparatus: relay contacts may be connected to any IS circuit without further consideration

User switch settings for operating mode

Mode	Function	SW1	SW2	SW3	SW4
Contact/Logic Input	2 ch	Off	On	On	On
	1in2out	On	On	On	On
Loop Powered	2 ch	Off	Off	Off	Off

The given data is only intended as a product description and should not be regarded as a legal warranty of properties or guarantee. In the interest of further technical developments, we reserve the right to make design changes.



EUROPE (EMEA): +44 (0)1582 723633
enquiry@mtl-inst.com

THE AMERICAS: +1 800 835 7075
csinfo@mtl-inst.com

ASIA-PACIFIC: +65 6 645 9888
sales.mtlsing@cooperindustries.com

EPSx526 Rev5 210513

MTL4531 – MTL5531 VIBRATION TRANSDUCER INTERFACE

The MTLx531 repeats a signal from a vibration sensor in a hazardous area, providing an output for a monitoring system in the safe area. The interface is compatible with 3-wire eddy-current probes and accelerometers or 2-wire current sensors; the selection is made by a switch on the side of the module.

SPECIFICATION

See also common specification

Number of channels

One

Sensor type

2- or 3-wire vibration transducer

Location of signal source

Zone 0, IIC, T4–6 hazardous area if suitably certified
Div. 1, Group A hazardous location

Hazardous-area input

Input impedance
(terminals 2 & 3): 10k Ω

Transducer supply voltage, 3-wire (terminals 3 & 1)

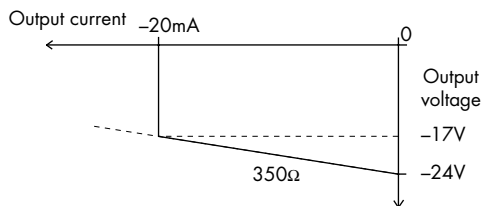

Transducer supply current, 2-wire

3.3mA (nom.) for 2-wire sensors, user selectable by switch

Signal range

Minimum -20V, maximum -0.5V

DC transfer accuracy at 20°C

< \pm 50mV

AC transfer accuracy at 20°C

0Hz to 1kHz: \pm 1%
1kHz to 10kHz: -5% to +1%
10kHz to 20kHz: -10% to +1%

Temperature coefficient

\pm 50ppm/ $^{\circ}$ C (10 to 65 $^{\circ}$ C)
 \pm 100ppm/ $^{\circ}$ C (-20 to 10 $^{\circ}$ C)

Voltage bandwidth

-3dB at 47kHz (typical)

Phase response

<14 μ s, equivalent to:
-1 $^{\circ}$ at 200Hz
-3 $^{\circ}$ at 600Hz
-5 $^{\circ}$ at 1kHz
-50 $^{\circ}$ at 10kHz
-100 $^{\circ}$ at 20kHz

Safe-area output impedance

<20 Ω

MTL4531

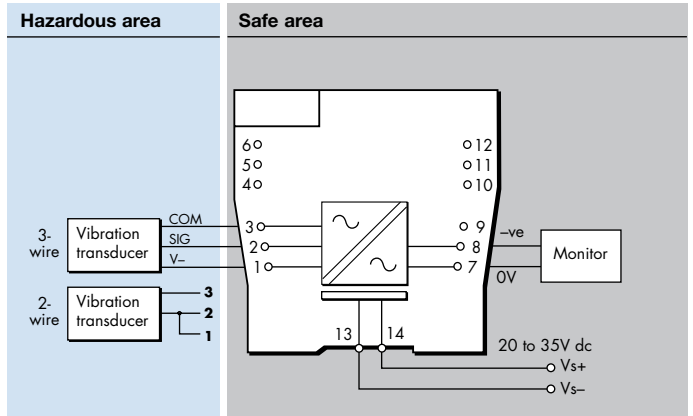

MTL5531

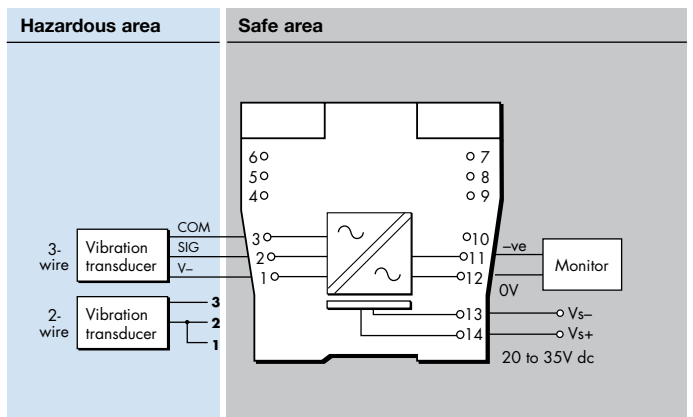

LED indicator

Green: power indication

Supply voltage

20 to 35V dc

Maximum current consumption (10mA transducer load)

96mA at 24V

Maximum power dissipation within unit

2W

Safety description

Terminals 3 to 1

$U_o=26.6V$ $I_o=94mA$ $P_o=0.66W$ $U_m = 253V$ rms or dc

Terminals 3 to 2

Non-energy-storing apparatus $\leq 1.5V$, $\leq 0.1A$ and $\leq 25mW$

Note -

Refer to the Instruction Manual for recommendations on mounting of these modules.

Due to the high power dissipation the maximum ambient temperature for these modules when mounted in horizontal orientation is:

- close packed 45 $^{\circ}$ C
- minimum of 10mm spacing 55 $^{\circ}$ C

The given data is only intended as a product description and should not be regarded as a legal warranty of properties or guarantee. In the interest of further technical developments, we reserve the right to make design changes.



EUROPE (EMEA): +44 (0)1582 723633
enquiry@mtl-inst.com

THE AMERICAS: +1 800 835 7075
csinfo@mtl-inst.com

ASIA-PACIFIC: +65 6 645 9888
sales.mtl@cooperindustries.com

EPSx531 Rev4 120913

MTL4532 – MTL5532

PULSE ISOLATOR

pulse & 4/20mA current outputs

The MTLx532 isolates pulses from a switch, proximity detector, current pulse transmitter or voltage pulse transmitter located in a hazardous area. It is ideal for applications involving high pulse rates and fast response times, by repeating the pulses into the safe area. An analogue output proportional to frequency is also provided, together with a relay output, which may be configured to act as an alarm. Configuration is carried out with a personal computer.

SPECIFICATION

See also common specification

Number of channels

One, fully floating

Sensor type

Switch or proximity detector (NAMUR/BS EN 60947-5-6:2001)
2- or 3-wire voltage or pulse transmitter

Location of switch

Zone 0, IIC, T6 hazardous area
Div. 1, Group A, hazardous location

Location of proximity detector or transmitter

Zone 0, IIC, T4-T6 if suitably certified
Div.1, Group A, hazardous location

Input

Switch input:

Output ON if switch is closed

Proximity detector input:

Excitation: 7.0 to 9.0V dc from 1k Ω nominal

Output ON if input > 2.1mA* (< 2k Ω)

Output OFF if input < 1.2mA* (> 10k Ω)

Switching hysteresis: 0.2mA (650 Ω) nominal

*NAMUR and BS EN 60947-5-6:2001 standards

Current pulse input:

Transmitter supply: 16.5V dc at 20mA

Short circuit current: 24mA

Output: $I_{in} > 9.0mA = ON$, $I_{in} < 7.0mA = OFF$

Switching hysteresis: 0.5mA

Voltage pulse input

Input impedance: > 10k Ω

Switching point voltage (V_{sp}): 3, 6, or 12V nominal

(User selectable by switches on the side of the module)

Output: $V_{in} > V_{sp} = ON$, $V_{in} < V_{sp} = OFF$

Switching hysteresis: 100mV + (0.1 x V_{sp}) typical

Safe-area pulse output

Maximum delay: 10 μ s

Maximum off-state voltage: 35V

Maximum off-state leakage current: 10 μ A

Maximum on-state resistance: 25 Ω

Maximum on-state current: 50mA

Output OFF if supply fails

Note: LFD signal is Zener-diode protected against inductive loads

Safe-area current output

Input capture delay: 2 signal periods (5ms min.)

Signal range: 4 to 20mA

Under/over range: 0 to 22mA

Load resistance: 0 to 450 Ω @20mA

Output resistance: >1M Ω

Ripple: < 50 μ A peak-to-peak

Accuracy: better than 20 μ A at 20 $^{\circ}$ C

Temperature drift: < 1 μ A/ $^{\circ}$ C

Risetime (10% - 90%, after step change): 60 ms

Alarm output

Relay ON in alarm, 0.5A @ 35Vdc max.

MTL4532

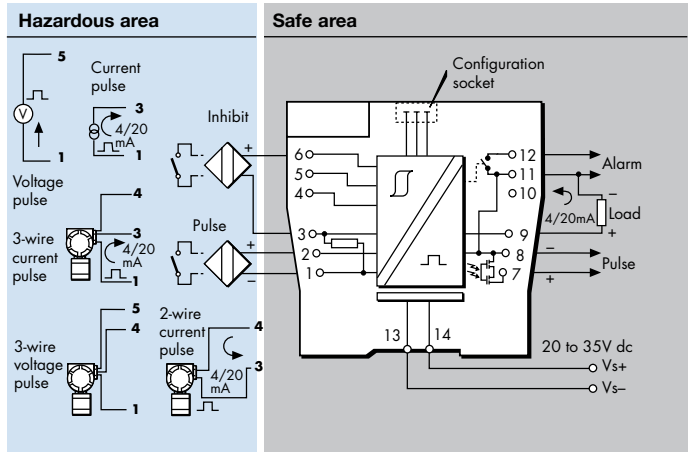

MTL5532

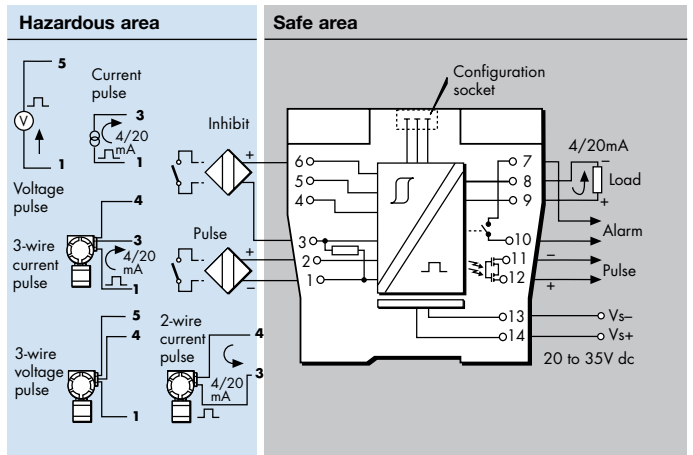

Pulse width

High: 10 μ s min

Low: 10 μ s min

Frequency range

0 - 50kHz - pulse output mode

0 - 10kHz - for analogue output

LED indicators

Green: power indication

Yellow: on when output circuit is on

Red: flashing when line fault or error

Power requirement

65mA at 24V dc

70mA at 20V dc

55mA at 35V dc

Power dissipation within unit

1.35W maximum at 24V

1.75W maximum at 35V

Safety description ($U_m = 253V$ rms or dc)

Terminals 2 to 1 and 6 to 1

$U_o = 10.5V$, $I_o = 14mA$, $P_o = 37mW$

Terminals 4 to 3 and 1

$U_o = 28V$, $I_o = 93mA$, $P_o = 651mW$

Terminals 3 to 1

Non-energy-storing apparatus $\leq 1.5V$, $\leq 0.1A$ and $\leq 25mW$; can be connected without further certification into any IS loop with an open-circuit voltage < 28V

Terminals 5 to 4 and 1

$V_{max} \leq 28V$, $I_{max} \leq 94mA$, $P_{max} \leq 0.66W$

Configurator

A personal computer running MTL PCS45 software with a PCL45USB serial interface.

The given data is only intended as a product description and should not be regarded as a legal warranty of properties or guarantee. In the interest of further technical developments, we reserve the right to make design changes.



EUROPE (EMEA): +44 (0)1582 723633
enquiry@mtl-inst.com

THE AMERICAS: +1 800 835 7075
csinfo@mtl-inst.com

ASIA-PACIFIC: +65 6 645 9888
sales.mtling@cooperindustries.com

EPs532 Rev4 210513

MTL5533

VIBRATION TRANSDUCER INTERFACE

2-channel

The MTL5533 repeats signals from vibration sensors in a hazardous area, providing outputs for a monitoring system in the safe area. The interface is compatible with 3-wire eddy-current probes and accelerometers or 2-wire current sensors, the selection is made by switches on the side of the module.

SPECIFICATION

See also common specification

Number of channels

Two

Sensor type

2- or 3-wire vibration transducer

Location of signal source

Zone 0, IIC, T4-6 hazardous area if suitably certified
Div. 1, Group A hazardous location

Hazardous-area input

Input impedance
(terminals 2 & 3, 5 & 6): 10k Ω

Transducer supply voltage, 3-wire (terminals 3 & 1 and 6 & 4)

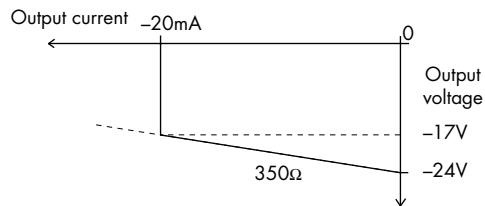

Transducer supply current, 2-wire

3.3mA (nom.) for 2-wire sensors, user selectable by switch

Signal range

Minimum -20V, maximum -0.5V

DC transfer accuracy at 20°C

< \pm 50mV

AC transfer accuracy at 20°C

0Hz to 1kHz: \pm 1%
1kHz to 10kHz: -5% to +1%
10kHz to 20kHz: -10% to +1%

Temperature coefficient

\pm 50ppm/ $^{\circ}$ C (10 to 65 $^{\circ}$ C)
 \pm 100ppm/ $^{\circ}$ C (-20 to 10 $^{\circ}$ C)

Voltage bandwidth

-3dB at 47kHz (typical)

Phase response

<14 μ s, equivalent to:
-1 $^{\circ}$ at 200Hz
-3 $^{\circ}$ at 600Hz
-5 $^{\circ}$ at 1kHz
-50 $^{\circ}$ at 10kHz
-100 $^{\circ}$ at 20kHz

Safe-area output impedance

<20 Ω

MTL5533

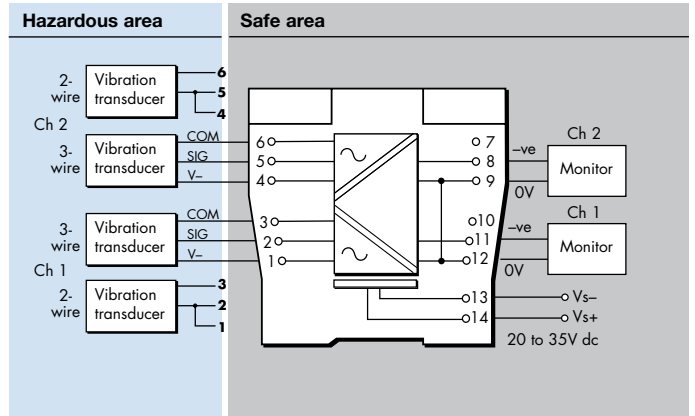

LED indicator

Green: power indication

Supply voltage

20 to 35V dc

Maximum current consumption (10mA transducer load/ch)

130mA at 24V

Maximum power dissipation within unit

2.7W *

Safety description

Terminals 3 to 1 and 6 to 4

$U_o=26.6V$ $I_o=94mA$ $P_o=0.66W$ $U_m = 253V$ rms or dc

Terminals 3 to 2 and 6 to 5

Non-energy-storing apparatus $\leq 1.5V$, $\leq 0.1A$ and $\leq 25mW$

Note -

Refer to the Instruction Manual for recommendations on mounting of these modules.

A minimum spacing of 10mm must be applied between these and any other modules on the DIN-rail.

The given data is only intended as a product description and should not be regarded as a legal warranty of properties or guarantee. In the interest of further technical developments, we reserve the right to make design changes.



EUROPE (EMEA): +44 (0)1582 723633
enquiry@mtl-inst.com

THE AMERICAS: +1 800 835 7075
csinfo@mtl-inst.com

ASIA-PACIFIC: +65 6 645 9888
sales.mtlsing@cooperindustries.com

EPS5533 Rev4 120913

MTL4541/S – MTL5541/S

REPEATER POWER SUPPLY

4/20mA, HART®, 2- or 3-wire transmitters

The MTLx541 provides a fully-floating dc supply for energising a conventional 2- or 3-wire 4/20mA transmitter, which is located in a hazardous area, and repeats the current in another floating circuit to drive a safe-area load. For HART 2-wire transmitters, the unit allows bi-directional communications signals superimposed on the 4/20mA loop current. Alternatively, the MTLx541S acts as a current sink for a safe-area connection rather than driving a current into the load. Separately powered current sources, such as 4-wire transmitters, can be connected but will not support HART communication.

SPECIFICATION

See also common specification



Number of channels

One

Location of transmitter

Zone 0, IIC, T4–6 hazardous area if suitably certified
Div. 1, Group A hazardous location

Safe-area output

Signal range: 4 to 20mA
Under/over-range: 0 to 24mA
Safe-area load resistance (MTLx541)
@ 24mA: 0 to 360Ω
@ 20mA: 0 to 450Ω

Safe-area load (MTLx541S)

Current sink: 600Ω max.
Maximum voltage source: 24V dc

Safe-area circuit output resistance: > 1MΩ

Safe-area circuit ripple

< 50μA peak-to-peak

Hazardous-area input

Signal range: 0 to 24mA (including over-range)
Transmitter voltage: 16.5V at 20mA

Transfer accuracy at 20°C

Better than 15μA

Temperature drift

< 0.8μA/°C

Response time

Settles to within 10% of final value within 50μs

Communications supported

HART (terminals 1 & 2 only)

MTL4541 / MTL4541S

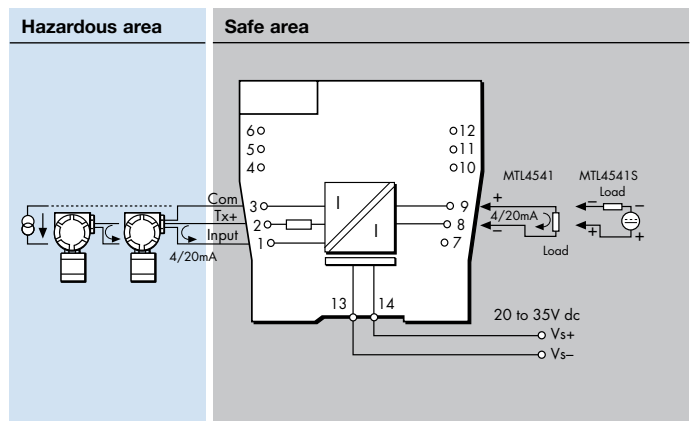

MTL5541 / MTL5541S

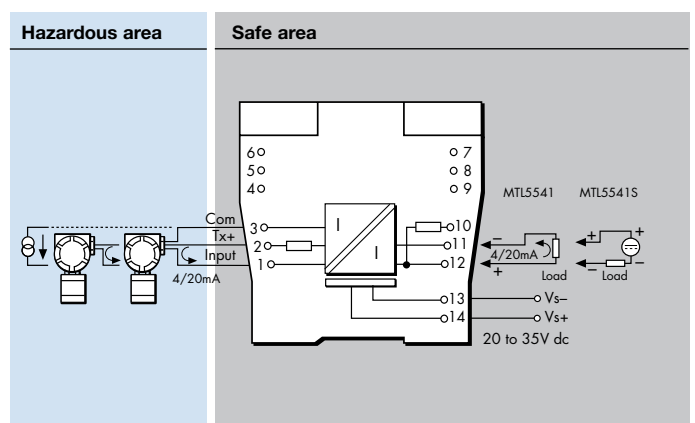

LED indicator

Green: power indication

Maximum current consumption (with 20mA signal)

51mA at 24V

Power dissipation within unit (with 20mA signal)

MTLx541 0.7W @ 24V dc
MTLx541S 1.0W @ 24V dc

Safety description

Terminals 2 to 1 and 3:

$U_o=28V$ $I_o=93mA$ $P_o=651mW$ $U_m = 253V$ rms or dc

Terminals 1 to 3:

Simple apparatus $\leq 1.5V$, $\leq 0.1A$ and $\leq 25mW$; can be connected without further certification into any IS loop with an open-circuit voltage <28V



SIL capable

These models have been assessed for use in IEC 61508 functional safety applications. See data on MTL web site and refer to the safety manual.

The given data is only intended as a product description and should not be regarded as a legal warranty of properties or guarantee. In the interest of further technical developments, we reserve the right to make design changes.



EUROPE (EMEA): +44 (0)1582 723633
enquiry@mtl-inst.com

THE AMERICAS: +1 800 835 7075
csinfo@mtl-inst.com

ASIA-PACIFIC: +65 6 645 9888
sales.mtlsing@cooperindustries.com

EPSx541/S Rev4 200913

MTL4541A/AS – MTL5541A/AS

CURRENT REPEATER

4/20mA passive i/p for HART® transmitters

The MTLx541A provides an input for separately powered 4/20mA transmitters and also allows bi-directional transmission of HART communication signals superimposed on the 4/20mA loop current. Alternatively, the MTLx541AS acts as a current sink for a safe-area connection rather than driving a current into the load.

SPECIFICATION

See also common specification

Number of channels

One

Location of transmitter

Zone 0, IIC, T4–6 hazardous area if suitably certified
Div.1, Group A, hazardous location

Hazardous area input

Signal range: 4 to 20mA
Under/over-range: 1.0 to 21.5mA

Input impedance for HART signals

at terminals 1, 2: > 230Ω

Maximum input volt drop

at terminals 1, 2: < 6.6V
i.e. a transmitter load of 330Ω at 20mA

Safe-area output

Signal range: 4 to 20mA
Under/over-range: 1.0 to 21.5mA

Safe-area load resistance (MTLx541A)

Conventional transmitters: 0 to 360Ω
Smart transmitters: 250Ω ±10%

Safe-area load (MTLx541AS)

Current sink: 600Ω max.
Maximum voltage source: 24V DC

Safe-area circuit output resistance: > 1MΩ

Safe-area circuit ripple

< 50μA peak-to-peak up to 80kHz

Transfer accuracy at 20°C

Better than 20μA

Temperature drift

< 1μA/°C

Response time

Settles within 200μA of final value after 20ms

Communications supported

HART

MTL4541A / MTL4541AS

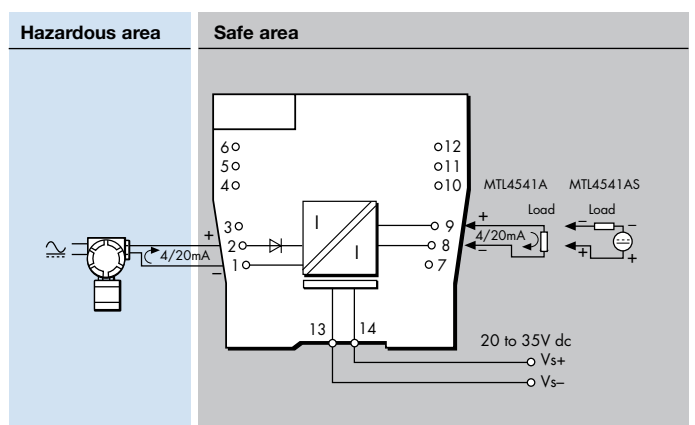

MTL5541A / MTL5541AS

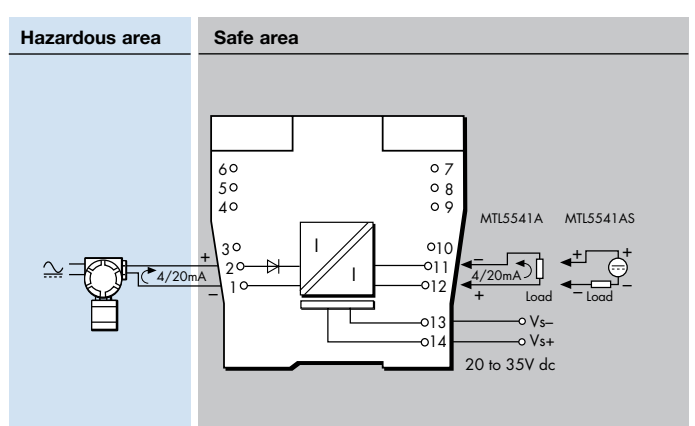

LED indicator

Green: power indication

Power requirement (with 20mA signal)

50mA at 20V
45mA at 24V
35mA at 35V

Power dissipation within unit (with 20mA signals)

MTLx541A 0.8W @ 24V dc
MTLx541AS 1.1W @ 24V dc

Safety description

Terminals 1 to 2:

$U_m = 253V$ rms or dc.

8.6V (diode). This voltage must be considered when calculating the load capacitance.

Non-energy-storing apparatus $\leq 1.5V$, $\leq 0.1A$ and $\leq 25mW$; can be connected without further certification into any IS loop with an open-circuit voltage <28V

The given data is only intended as a product description and should not be regarded as a legal warranty of properties or guarantee. In the interest of further technical developments, we reserve the right to make design changes.



EUROPE (EMEA): +44 (0)1582 723633
enquiry@mtl-inst.com

THE AMERICAS: +1 800 835 7075
csinfo@mtl-inst.com

ASIA-PACIFIC: +65 6 645 9888
sales.mtlsing@cooperindustries.com

EPSx541A/AS Rev3 210513

MTL4541T

REPEATER POWER SUPPLY

4/20mA, 2- or 3-wire transmitters using long field lines

The MTL4541T provides a fully-floating dc supply for energising a conventional 2- or 3-wire 4/20mA transmitter, which is located in a hazardous area, and repeats the current in another floating circuit to drive a safe-area load. For HART 2-wire transmitters, the unit allows bi-directional communications signals superimposed on the 4/20mA loop current. Separately powered current sources, such as 4-wire transmitters, can be connected but will not support HART communication. The reduced maximum open-circuit voltage permits the use of longer field lines compared to MTL4541.

SPECIFICATION

See also common specification

Number of channels

One

Location of transmitter

Zone 0, IIC, T4–6 hazardous area if suitably certified
Div. 1, Group A hazardous location

Safe-area output

Signal range: 4 to 20mA
Under/over-range: 0 to 24mA
Safe-area load resistance
@ 24mA: 0 to 250Ω
@ 20mA: 0 to 325Ω

Safe-area circuit ripple

< 50μA peak-to-peak

Hazardous-area input

Signal range: 0 to 24mA (including over-range)
Transmitter voltage: 14V at 20mA

Transfer accuracy at 20°C

Better than 15μA

Temperature drift

< 0.8μA/°C

Response time

Settles to within 10% of final value within 50μs

Communications supported

HART (terminals 1 & 2 only)

MTL4541T

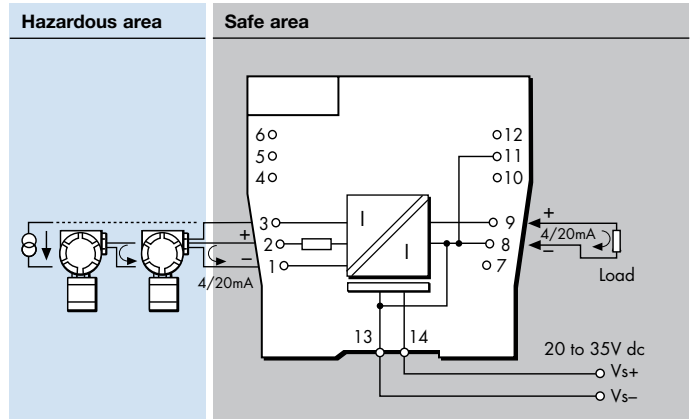

LED indicator

Green: power indication

Maximum current consumption (with 20mA signal)

51mA at 24V

Power dissipation within unit (with 20mA signal)

0.7W @ 24V dc

Safety description

Terminals 2 to 1:

$V_o=22V$ $I_o=167mA$ $P_o=920mW$ $U_m = 253V$ rms or dc

Terminals 3 to 1:

Simple apparatus $\leq 1.5V$, $\leq 0.1A$ and $\leq 25mW$; can be connected without further certification into any IS loop with an open-circuit voltage <28V

The given data is only intended as a product description and should not be regarded as a legal warranty of properties or guarantee. In the interest of further technical developments, we reserve the right to make design changes.



EUROPE (EMEA): +44 (0)1582 723633
enquiry@mtl-inst.com

THE AMERICAS: +1 800 835 7075
csinfo@mtl-inst.com

ASIA-PACIFIC: +65 6 645 9888
sales.mtling@cooperindustries.com

EPS4541T Rev1 031013

MTL4544/S – MTL5544/S

REPEATER POWER SUPPLY

2-channel, 4/20mA, HART®, 2- or 3- wire transmitters

The MTLx544 provides fully-floating dc supplies for energising two conventional 2-wire or 3-wire 4/20mA or HART transmitters located in a hazardous area, and repeats the current in other circuits to drive two safe-area loads. For smart transmitters, the unit allows bi-directional transmission of digital communication signals superimposed on the 4/20mA loop current. Alternatively, the MTLx544S acts as a current sink for a safe-area connection rather than driving a current into the load. Separately powered current sources, such as 4-wire transmitters, can be connected but will not support HART communication.

SPECIFICATION

See also common specification



Number of channels

Two

Location of transmitter

Zone 0, IIC, T4–6 hazardous area if suitably certified
Div. 1, Group A hazardous location

Safe-area output

Signal range: 4 to 20mA
Under/over-range: 0 to 24mA
Safe-area load resistance (MTLx 544)
@ 24mA: 0 to 360Ω
@ 20mA: 0 to 450Ω

Safe-area load (MTLx544S)

Current sink: 600Ω max.
Maximum voltage source: 24V dc

Safe-area circuit output resistance: > 1MΩ

Safe-area circuit ripple

< 50μA peak-to-peak

Hazardous-area input

Signal range: 0 to 24mA (including over-range)
Transmitter voltage: 16.5V at 20mA

Transfer accuracy at 20°C

Better than 15μA

Temperature drift

< 0.8μA/°C

Response time

Settles to within 10% of final value within 50μs

Communications supported

HART (terminals 1 & 2 and 4 & 5 only)

MTL4544 / MTL4544S

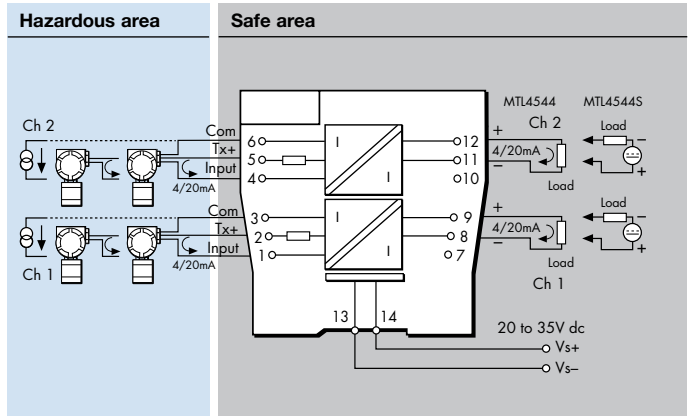

MTL5544 / MTL5544S

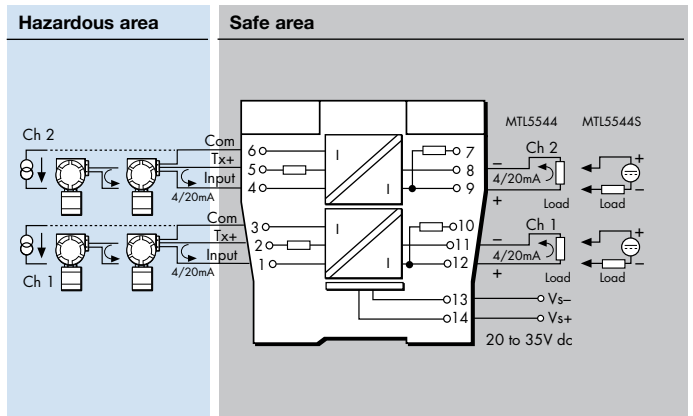

LED indicator

Green: power indication

Maximum current consumption (with 20mA signals)

96mA at 24V dc

Power dissipation within unit (with 20mA signals)

MTLx544 1.4W @ 24V dc

MTLx544S 1.9W @ 24V dc

Safety description (each channel)

Terminals 2 to 1 and 3, and 5 to 4 and 6:

$U_o=28V$ $I_o=93mA$ $P_o=651mW$ $U_m=253V$ rms or dc

Terminals 1 to 3 and 4 to 6:

Simple apparatus $\leq 1.5V$, $\leq 0.1A$ and $\leq 25mW$; can be connected without further certification into any IS loop with an open-circuit voltage < 28V



SIL capable

These models have been assessed for use in IEC 61508 functional safety applications. See data on MTL web site and refer to the safety manual.

The given data is only intended as a product description and should not be regarded as a legal warranty of properties or guarantee. In the interest of further technical developments, we reserve the right to make design changes.



EUROPE (EMEA): +44 (0)1582 723633
enquiry@mtl-inst.com

THE AMERICAS: +1 800 835 7075
csinfo@mtl-inst.com

ASIA-PACIFIC: +65 6 645 9888
sales.mtlsing@cooperindustries.com

EP5x544/S Rev4 200913

MTL4544A/AS – MTL5544A/AS CURRENT REPEATER

4/20mA passive i/p for HART® transmitters

The MTLx544A provides an input for separately powered 4/20mA transmitters and also allows bi-directional transmission of HART communication signals superimposed on the 4/20mA loop current, so that the transmitter can be interrogated either from the operator station or by a hand-held communicator (HHC). Alternatively, the MTLx544AS acts as a current sink for a safe-area connection rather than driving a current into the load.

SPECIFICATION

See also common specification

Number of channels

Two

Location of transmitter

Zone 0, IIC, T4-6 hazardous area if suitably certified
Div.1, Group A, hazardous location

Hazardous area input

Signal range: 4 to 20mA
Under/over-range: 1.0 to 21.5mA

Input impedance for HART signals

at terminals 1, 2 and 4, 5: > 230Ω

Maximum input volt drop

at terminals 1, 2 and 4, 5: < 6.6V
i.e. a transmitter load of 330Ω at 20mA

Safe-area output

Signal range: 4 to 20mA
Under/over-range: 1.0 to 21.5mA
Safe-area load resistance (MTL5544A)
Conventional transmitters: 0 to 360Ω
Smart transmitters: 250Ω ±10%
Safe-area load (MTL5544AS)
Current sink: 600Ω max.
Maximum voltage source: 24V DC
Safe-area circuit output resistance: > 1MΩ

Safe-area circuit ripple

< 50μA peak-to-peak up to 80kHz

Transfer accuracy at 20°C

Better than 20μA

Temperature drift

< 1μA/°C

Response time

Settles within 200μA of final value after 20ms

Communications supported

HART

MTL4544A / MTL4544AS

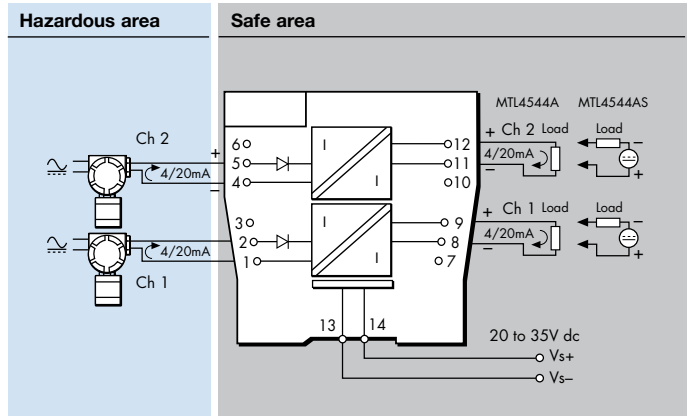

MTL5544A / MTL5544AS

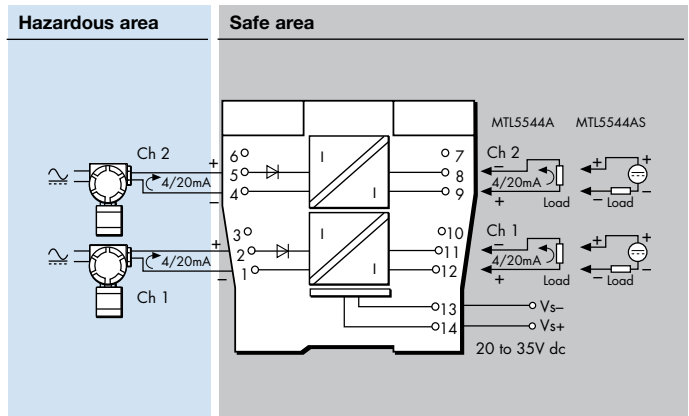

LED indicator

Green: power indication

Power requirement (with 20mA signal)

70mA at 24V
85mA at 20V
50mA at 35V

Power dissipation within unit (with 20mA signals)

MTLx544A 1.5W @ 24V dc
MTLx544AS 2.0W @ 24V dc

Safety description

Terminals 1 to 2 and 4 to 5:

$U_m = 253V$ rms or dc.

8.6V (diode). This voltage must be considered when calculating the load capacitance.

Non-energy-storing apparatus ≤1.5V, ≤0.1A and ≤25mW; can be connected without further certification into any IS loop with an open-circuit voltage < 28V

The given data is only intended as a product description and should not be regarded as a legal warranty of properties or guarantee. In the interest of further technical developments, we reserve the right to make design changes.



EUROPE (EMEA): +44 (0)1582 723633
enquiry@mtl-inst.com

THE AMERICAS: +1 800 835 7075
csinfo@mtl-inst.com

ASIA-PACIFIC: +65 6 645 9888
sales.mtlsing@cooperindustries.com

EPSx544A/AS Rev3 210513

MTL4544D – MTL5544D

REPEATER POWER SUPPLY

single channel, 4/20mA, HART®
for 2- or 3-wire transmitters, two outputs

The MTLx544D provides a fully-floating dc supply for energising a conventional 2- or 3-wire 4/20mA transmitter located in a hazardous area, and repeats the current in other circuits to drive two safe-area loads. For HART 2-wire transmitters, the unit allows bi-directional transmission of digital communication signals superimposed on the 4/20mA loop current. Separately powered current sources, such as 4-wire transmitters, can be connected but will not support HART communication.

SPECIFICATION

See also common specification



Number of channels

One

Location of transmitter

Zone 0, IIC, T4–6 hazardous area if suitably certified
Div. 1, Group A hazardous location

Safe-area output

Signal range: 4 to 20mA
Under/over-range: 0 to 24mA
Safe-area load resistance
@ 24mA: 0 to 360Ω
@ 20mA: 0 to 450Ω
Safe-area circuit output resistance: > 1MΩ

Safe-area circuit ripple

< 50μA peak-to-peak

Hazardous-area input

Signal range: 0 to 24mA (including over-range)
Transmitter voltage: 16.5V at 20mA

Transfer accuracy at 20°C

Better than 15μA

Temperature drift

< 0.8μA/°C

Response time

Settles to within 10% of final value within 50μs

Communications supported

HART (terminals 1 & 2, output Ch 1 only)

MTL4544D

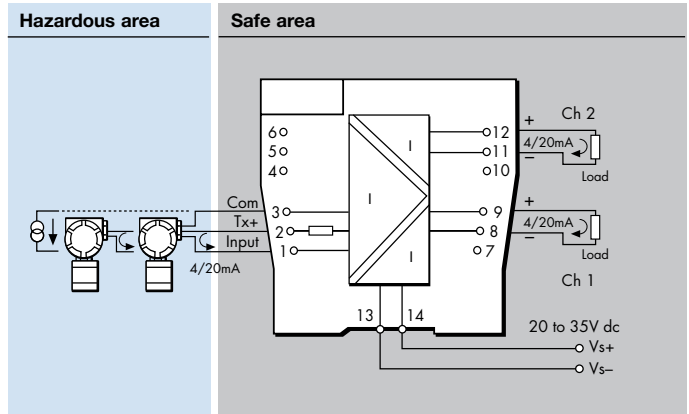

MTL5544D

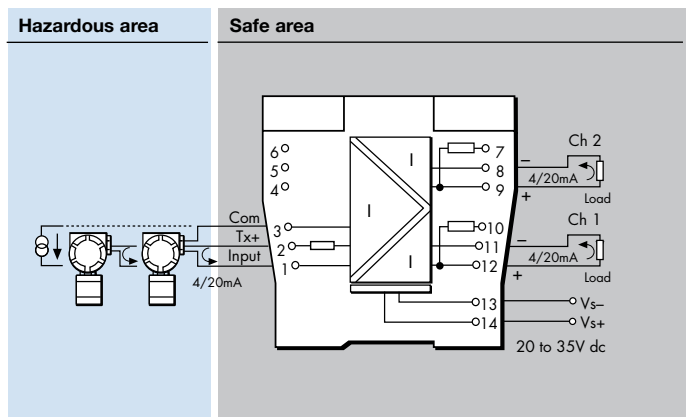

LED indicator

Green: power indication

Maximum current consumption (with 20mA signals)

96mA at 24V dc

Power dissipation within unit (with 20mA signals)

1.4W @ 24V dc

Safety description

Terminals 2 to 1 and 3:

$U_o=28V$ $I_o=93mA$ $P_o=651mW$ $U_m=253V$ rms or dc

Terminals 1 to 3:

Simple apparatus $\leq 1.5V$, $\leq 0.1A$ and $\leq 25mW$; can be connected without further certification into any IS loop with an open-circuit voltage <28V



SIL capable

These models have been assessed for use in IEC 61508 functional safety applications. See data on MTL web site and refer to the safety manual.

The given data is only intended as a product description and should not be regarded as a legal warranty of properties or guarantee. In the interest of further technical developments, we reserve the right to make design changes.



EUROPE (EMEA): +44 (0)1582 723633
enquiry@mtl-inst.com

THE AMERICAS: +1 800 835 7075
csinfo@mtl-inst.com

ASIA-PACIFIC: +65 6 645 9888
sales.mtl@cooperindustries.com

EPSx544D Rev4 200913

MTL4546/C/Y – MTL5546/Y

ISOLATING DRIVER

for 4–20mA HART® valve positioners with line fault detection

The MTLx546 accepts a 4/20mA floating signal from a safe-area controller to drive a current/pressure converter (or any other load up to 800Ω) in a hazardous area. For HART valve positioners, the module also permits bi-directional transmission of digital communication signals. Process controllers with a readback facility can detect open or short circuits in the field wiring: if these occur, the current taken into the terminals drops to a preset level. The MTL4546C and the MTLx546Y are very similar to the MTLx546 except that they provide open circuit detection only (i.e. no short-circuit detection).

SPECIFICATION

See also common specification



Number of channels

One

Location of I/P converter

Zone 0, IIC, T4–6 hazardous area if suitably certified
Div. 1, Group A, hazardous location

Working range

4 to 20mA

Digital signal bandwidth

500Hz to 10kHz

Maximum load resistance

800Ω (16V at 20mA)

Minimum load resistance

90Ω (short-circuit detection at < 50Ω)

Output resistance

> 1MΩ

Under/over range capability

Under range = 1mA
Over range = 24mA (load ≤ 520Ω)

Input and output circuit ripple

< 40μA peak-to-peak

Transfer accuracy at 20°C

Better than 20μA

Temperature drift

< 1.0μA/°C

Input characteristics

Field wiring state	MTLx546	MTL4546C	MTLx546Y
Normal	< 6.0V	< 6.0V	< 6.0V
Open-circuit	< 0.9mA	< 0.9mA	< 0.5mA
Short-circuit	< 0.9mA	N.A.	N.A.

Response time

Settles within 200μA of final value within 100ms

Communications supported

HART

MTL4546 / MTL4546C / MTL4546Y

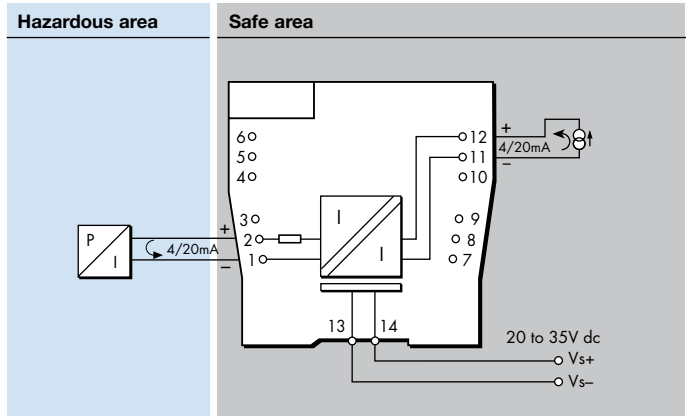

MTL5546 / MTL5546Y

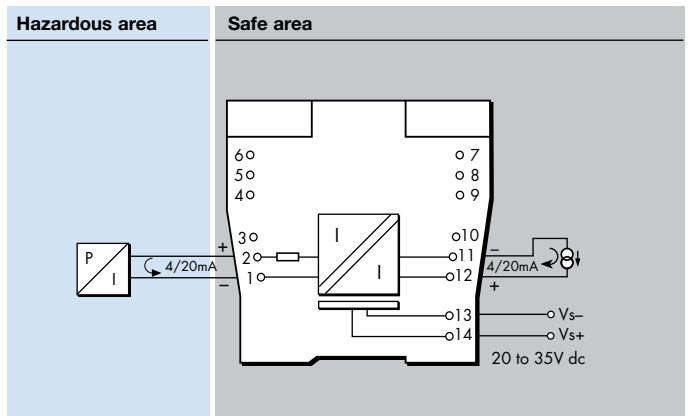

LED indicator

Green: power indication

Maximum current consumption (with 20mA signals into 250Ω load)

35mA at 24V dc

Power dissipation within unit (with 20mA signals into 250Ω load)

0.8W at 24V

Safety description

$U_o=28V$ $I_o=93mA$ $P_o=651mW$ $U_m = 253V$ rms or dc



SIL capable

These models have been assessed for use in IEC 61508 functional safety applications. See data on MTL web site and refer to the safety manual.

The given data is only intended as a product description and should not be regarded as a legal warranty of properties or guarantee. In the interest of further technical developments, we reserve the right to make design changes.



EUROPE (EMEA): +44 (0)1582 723633
enquiry@mtl-inst.com

THE AMERICAS: +1 800 835 7075
csinfo@mtl-inst.com

ASIA-PACIFIC: +65 6 645 9888
sales.mtlsing@cooperindustries.com

EPSx546/C/Y Rev4 200913

MTL4546S

ISOLATING DRIVER

for 4–20mA HART® valve positioners with line fault detection and long field lines

The MTL4546S accepts a 4/20mA floating signal from a safe-area controller to drive a current/pressure converter (or any other load up to 710Ω) in a hazardous area. For HART valve positioners, the module also permits bi-directional transmission of digital communication signals. Process controllers with a readback facility can detect open circuits in the field wiring: if these occur, the current taken into the terminals drops to a preset level. The reduced maximum open-circuit voltage permits the use of longer field lines compared to MTL4546

SPECIFICATION

See also common specification

Number of channels

One

Location of I/P converter

Zone 0, IIC, T4–6 hazardous area if suitably certified
Div. 1, Group A, hazardous location

Working range

4 to 20mA

Digital signal bandwidth

500Hz to 10kHz

Maximum load resistance

710Ω (14.2V at 20mA)

Minimum load resistance

90Ω

Output resistance

> 1MΩ

Under/over range capability

Under range = 1mA
Over range = 24mA (load ≤ 520Ω)

Input and output circuit ripple

< 40μA peak-to-peak

Transfer accuracy at 20°C

Better than 20μA

Temperature drift

< 1.0μA/°C

Input characteristics

Field wiring state	
Normal	< 6.0V
Open-circuit	< 0.9mA
Short-circuit	N.A.

Response time

Settles within 200μA of final value within 100ms

Communications supported

HART

MTL4546S

Hazardous area

Safe area

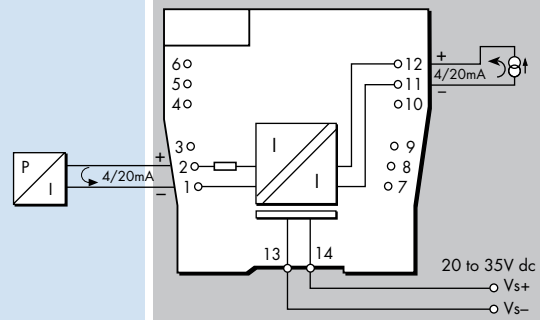

LED indicator

Green: power indication

Maximum current consumption (with 20mA signals into 250Ω load)

35mA at 24V dc

Power dissipation within unit (with 20mA signals into 250Ω load)

0.8W at 24V

Safety description

$V_o=22V$ $I_o=100mA$ $P_o=550mW$ $U_m = 253V$ rms or dc

The given data is only intended as a product description and should not be regarded as a legal warranty of properties or guarantee. In the interest of further technical developments, we reserve the right to make design changes.



EUROPE (EMEA): +44 (0)1582 723633
enquiry@mtl-inst.com

THE AMERICAS: +1 800 835 7075
csinfo@mtl-inst.com

ASIA-PACIFIC: +65 6 645 9888
sales.mtlsing@cooperindustries.com

EPS4546S 060813

MTL4549/C/Y - MTL5549/Y

ISOLATING DRIVER

two-channel, for 4–20mA, HART®
valve positioners with line fault detection

The MTLx549 accepts 4/20mA floating signals from safe-area controllers to drive 2 current/pressure converters (or any other load up to 800Ω) in a hazardous area. For HART valve positioners, the module also permits bi-directional transmission of digital communication signals. Process controllers with a readback facility can detect open or short circuits in the field wiring: if these occur, the current taken into the terminals drops to a preset level. The MTL4549C and MTLx549Y are very similar to the MTLx549 except that they provide open circuit detection only (i.e. no short-circuit detection).

SPECIFICATION

See also common specification

Number of channels

Two

Location of I/P converter

Zone 0, IIC, T4–6 hazardous area if suitably certified
Div. 1, Group A, hazardous location

Working range

4 to 20mA

Digital signal bandwidth

500Hz to 10kHz

Maximum load resistance

800Ω (16V at 20mA)

Minimum load resistance

90Ω (short-circuit detection at < 50Ω)

Output resistance

> 1MΩ

Under/over range capability

Under range = 1mA
Over range = 24mA (load ≤ 520Ω)

Input and output circuit ripple

< 40μA peak-to-peak

Communications supported

HART

Transfer accuracy at 20°C

Better than 20μA

Temperature drift

< 1.0μA/°C

Input characteristics

Field wiring state	MTL4549	MTL4549C	MTL4549Y
Normal	< 6.0V	< 6.0V	< 6.0V
Open-circuit	< 0.9mA	< 0.9mA	< 0.5mA
Short-circuit	< 0.9mA	N.A.	N.A.

Response time

Settles within 200μA of final value within 100ms



MTL4549 / MTL4549C / MTL4549Y

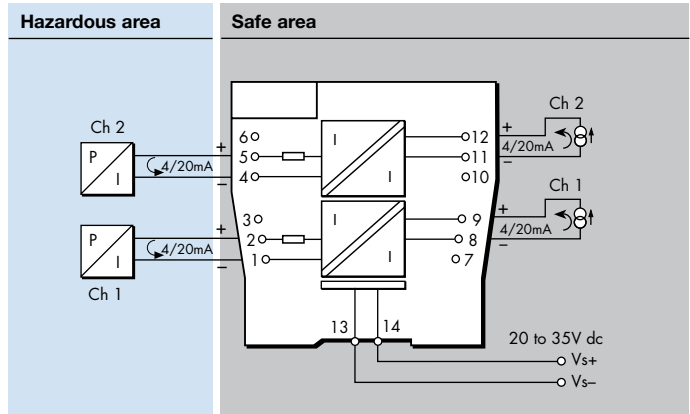

MTL5549 / MTL5549Y

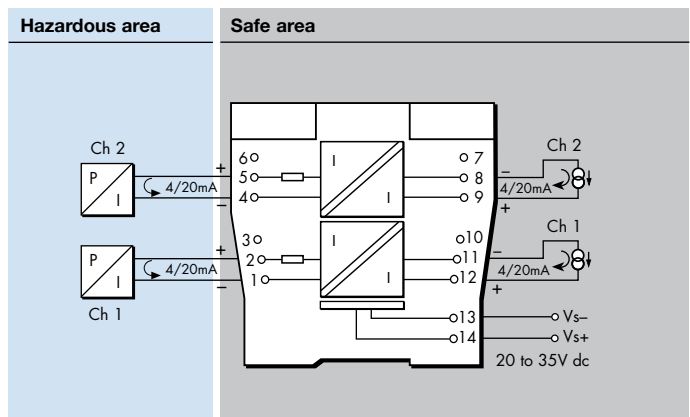

LED indicator

Green: power indication

Maximum current consumption (with 20mA signals into 250Ω load)

70mA at 24V dc

Power dissipation within unit (with 20mA signals into 250Ω load)

1.6W at 24V

Safety description (each channel)

$U_o = 28V$ $I_o = 93mA$ $P_o = 0.65W$ $U_m = 253V$ rms or dc



SIL capable

These models have been assessed for use in IEC 61508 functional safety applications. See data on MTL web site and refer to the safety manual.

The given data is only intended as a product description and should not be regarded as a legal warranty of properties or guarantee. In the interest of further technical developments, we reserve the right to make design changes.



EUROPE (EMEA): +44 (0)1582 723633
enquiry@mtl-inst.com

THE AMERICAS: +1 800 835 7075
csinfo@mtl-inst.com

ASIA-PACIFIC: +65 6 645 9888
sales.mtl@cooperindustries.com

EPSx549/C/Y Rev4 200913

MTL4561 – MTL5561

FIRE AND SMOKE DETECTOR INTERFACE

2-channel

The MTLx561 is a loop-powered 2-channel interface for use with conventional fire and smoke detectors located in hazardous areas. In operation, the triggering of a detector causes a corresponding change in the safe-area current. The unit features reverse input polarity protection, while 'no-fail' earth fault detection on either line can be provided by connecting an earth leakage detector to terminal 3 and/or 6.

SPECIFICATION

See also common specification



Number of channels

Two, fully floating, loop powered

Location of fire and smoke detectors

Zone 0, IIC, T4-6 hazardous area if suitably certified
Div. 1, Group A, hazardous area

Input voltage

6 to 30V dc

Current range

1 to 40mA, nominal

Quiescent safe-area current at 20°C

(hazardous-area terminals open circuit)
< 400µA at $V_{in} = 24V$ per channel

Integral input polarity protection

Input circuit protected against reverse polarity

'No-fail' earth fault protection

Enabled by connecting terminals 3 and/or 6 to an earth leakage detector (see notes below)
Fault on either line of each channel proclaimed: unit continues working

Minimum output voltage V_{out} at 20°C

For $V_{in} \leq 25V$: $V_{out} = V_{in} - (0.38 \times \text{current in mA}) - 2V$
For $V_{in} > 25V$: $V_{out} = 22.5V - (0.35 \times \text{current in mA})$

Maximum output voltage

28V from 300Ω

Transfer accuracy at 20°C

Better than 400µA

Temperature drift

< 4µA/°C (0°C to 60°C)
< 15µA/°C (-20°C to 0°C)

Response time to step input

Settles to within 5% of final value within 1.5ms

Power dissipation within unit

0.7W maximum at 24V with 40mA signal (each channel)
0.9W maximum at 30V with 40mA signal (each channel)

Notes:

- To maintain isolation between the two channels, separate earth leakage detectors are needed.
- The earth leakage detectors introduce a 100µA, 1Hz ripple to the field circuit.

MTL4561

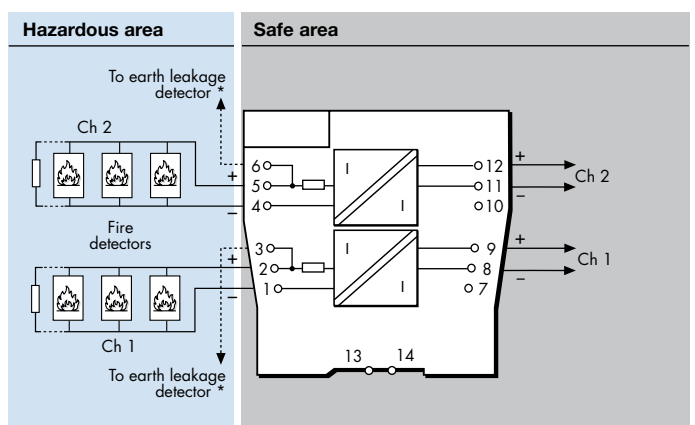

MTL5561

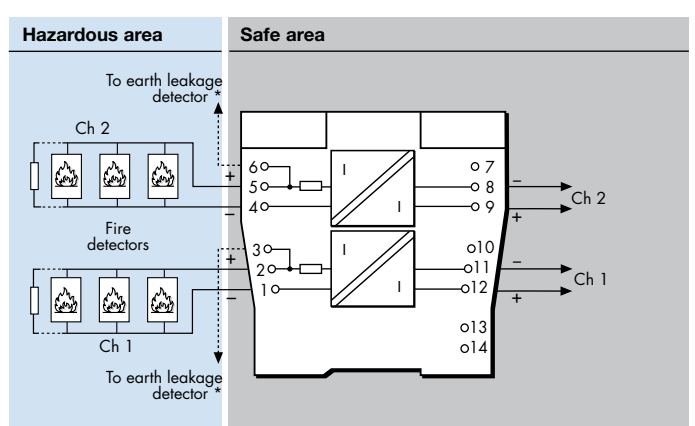

*Signal plug HAZ1-3 is required for access to this function

Safety description for each channel

$U_o = 28V$ $I_o = 93mA$ $P_o = 0.65W$ $U_m = 253V$ rms or dc



SIL capable

These models have been assessed for use in IEC 61508 functional safety applications. See data on MTL web site and refer to the safety manual.

The given data is only intended as a product description and should not be regarded as a legal warranty of properties or guarantee. In the interest of further technical developments, we reserve the right to make design changes.



EUROPE (EMEA): +44 (0)1582 723633
enquiry@mtl-inst.com

THE AMERICAS: +1 800 835 7075
csinfo@mtl-inst.com

ASIA-PACIFIC: +65 6 645 9888
sales.mtlsing@cooperindustries.com

EPSx561 Rev4 200913

MTL4575 – MTL5575

TEMPERATURE CONVERTER

THC or RTD input + Alarm

The MTLx575 converts a low-level dc signal from a temperature sensor mounted in a hazardous area into a 4/20mA current for driving a safe-area load. Software selectable features include linearisation, ranging, monitoring, testing and tagging for all thermocouple types and 2-, 3- or 4-wire RTDs. (For thermocouple applications the HAZ-CJC plug on terminals 1–3 includes an integral CJC sensor). Configuration is carried out using a personal computer. A single alarm output is provided and may be configured for process alarm or to provide notice of early thermocouple failure.

SPECIFICATION

See also common specification

Number of channels

One

Signal source

THC types J, K, T, E, R, S, B or N to BS 60584 and XK mV input
 RTDs 2/3/4-wire platinum to BS 60751
 Pt 100, Pt 500, Pt 1000
 Cu-50 & Cu-53
 Ni 100/500/1000 DIN 43760

Location of signal source

Zone 0, IIC, T4-6 hazardous area
 Division 1, Group A, hazardous location

Input signal range

-75 to +75mV, or 0 to 400Ω (0 to 1000Ω Pt & Ni sensors)

Input signal span

3 to 150mV, or 10 to 400Ω (10 to 1000Ω Pt & Ni sensors)

RTD excitation current

200μA nominal

Cold junction compensation

Automatic or selectable

Cold junction compensation error

≤ 1.0°C

Common mode rejection

120dB for 240V at 50Hz or 60Hz (500ms response)

Series mode rejection

40dB for 50Hz or 60Hz

Calibration accuracy (at 20°C)

(includes hysteresis, non-linearity and repeatability)

Inputs: (500ms response)

mV/THC: ± 15μV or ± 0.05% of input value (whichever is greater)

RTD: ± 80mΩ

Output: ± 11μA

Temperature drift (typical)

Inputs:

mV/THC: ± 0.003% of input value/°C

RTD: ± 7mΩ/°C

Output: ± 0.6μA/°C

Example of calibration accuracy and temperature drift

(RTD input - 500ms response)

Span: 250Ω

Accuracy: ± (0.08/250 + 11/16000) x 100%
 = 0.1% of span

Temperature drift: ± (0.007/250 x 16000 + 0.6) μA/°C
 = ±1.0μA/°C

Safety drive on sensor failure

Upscale, downscale, or off

MTL4575

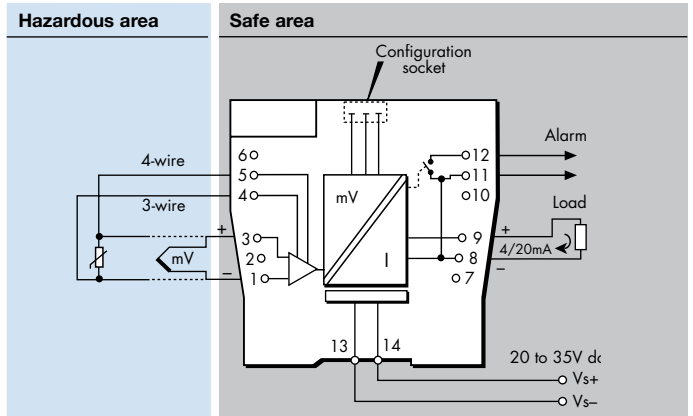

MTL5575

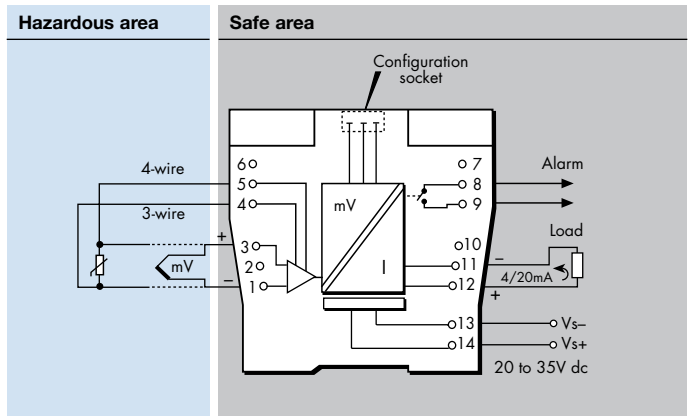

Early burnout

Early burnout detection for thermocouples (when selected)
 Alarm trips when loop resistance increase is > 50Ω

Output range

4 to 20mA nominal into 600Ω max.

Alarm output (configurable)

Relay ON in alarm, 250mA @ 35V max

Maximum lead resistance (THC)

600Ω

Response time

Configurable - 500 ms default
 (Accuracy at 100/200ms - contact MTL)

LED indicator

Green: power and status indication
 Yellow: alarm indication, on when contacts are closed

Maximum current consumption (with 20mA signal)

50mA at 24V

Power dissipation within unit (with 20mA signal)

1.2W at 24V

Safety description

Refer to certificate for parameters. $U_m=253V$ rms or dc

Configurator

A personal computer running MTL PCS45 software with a PCL45USB serial interface.

The given data is only intended as a product description and should not be regarded as a legal warranty of properties or guarantee. In the interest of further technical developments, we reserve the right to make design changes.



EUROPE (EMEA): +44 (0)1582 723633
 enquiry@mtl-inst.com

THE AMERICAS: +1 800 835 7075
 csinfo@mtl-inst.com

ASIA-PACIFIC: +65 6 645 9888
 sales.mtling@cooperindustries.com

ESP575 Rev3 041113

MTL4576-RTD – MTL5576-RTD

TEMPERATURE CONVERTER

RTD/potentiometer input, 2-channel

The MTLx576-RTD converts signals from resistance temperature detectors (RTDs) mounted in a hazardous area, into 4/20mA currents for driving safe-area loads. Software selectable features include input type and characterisation, ranging, monitoring, testing and tagging. Configuration is carried out using a personal computer. The MTLx576-RTD is compatible with 2- and 3-wire RTD inputs. The MTLx576-RTD can also be configured to drive two safe-area loads from a single input.

SPECIFICATION

See also common specification

Number of channels

Two

Signal source

2-/3-wire RTDs to BS 60751
Pt 100, Pt 500, Pt 1000
Cu-50 & Cu-53
Ni 100/500/1000 DIN 43760

Location of signal source

Zone 0, IIC, T4-6 hazardous area
Division 1, Group A, hazardous location

Input signal range

0 to 400Ω (0 to 4000Ω Pt & Ni sensors)

Input signal span

10 to 400Ω (10 to 1000Ω Pt & Ni sensors)

RTD excitation current

200μA nominal

Common mode rejection

120dB for 240V at 50Hz or 60Hz

Series mode rejection

40dB for 50Hz or 60Hz

Calibration accuracy (at 20°C)

(includes hysteresis, non-linearity and repeatability)

Input: ± 80mΩ

Output: ± 16μA

Temperature drift (typical)

Input: ± 7mΩ/°C

Output: ± 0.6μA/°C

Example of calibration accuracy and temperature drift (RTD input)

Span: 250Ω

Accuracy: ± (0.08/250 + 16/16000) x 100%
= 0.13% of span

Temperature drift: ± (0.007/250 x 16000 + 0.6) μA/°C
= ±1.0μA/°C

Safety drive on sensor failure

Upscale, downscale, or off

Output range

4 to 20mA nominal into 300Ω max.

Response time

Configurable - 500 ms default

(Accuracy at 100/200ms - contact MTL)

MTL4576-RTD

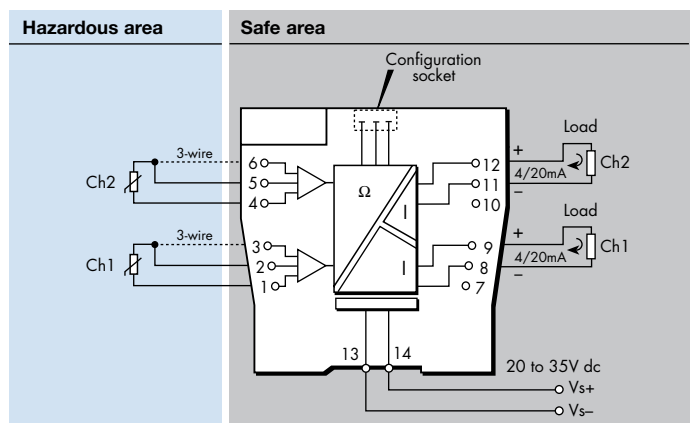

MTL5576-RTD

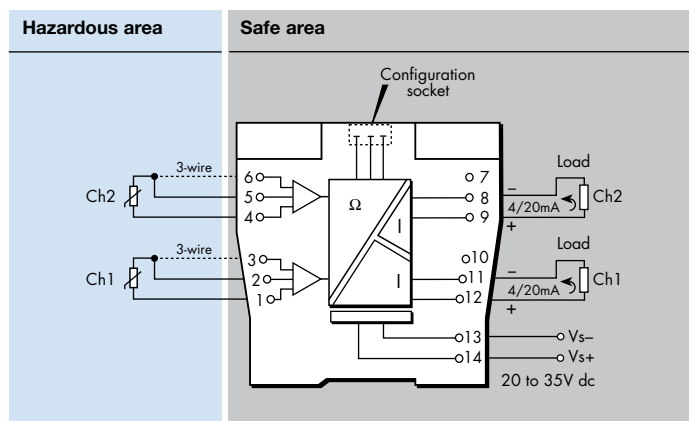

LED indicator

Green: power and status indication
Yellow: one provided for channel status
Red: alarm indication

Power requirement, Vs with 20mA signal

60mA at 24V

Power dissipation within unit with 20mA signal

1.4W at 24V

Isolation

Functional channel-channel isolation for safe and hazardous-area circuits

Safety description

Refer to certificate for parameters. $U_m = 253V$ rms or dc

Configurator

A personal computer running MTL PCS45 software with a PCL45USB serial interface.

The given data is only intended as a product description and should not be regarded as a legal warranty of properties or guarantee. In the interest of further technical developments, we reserve the right to make design changes.



EUROPE (EMEA): +44 (0)1582 723633
enquiry@mtl-inst.com

THE AMERICAS: +1 800 835 7075
csinfo@mtl-inst.com

ASIA-PACIFIC: +65 6 645 9888
sales.mtlsing@cooperindustries.com

EPSx576R Rev4 200913

MTL4576-THC – MTL5576-THC

TEMPERATURE CONVERTER

mV/THC input, 2-channel

The MTLx576-THC converts low-level dc signals from temperature sensors mounted in a hazardous-area into 4/20mA currents for driving safe-area loads. Software selectable features include linearisation for standard thermocouple types, ranging, monitoring, testing and tagging. Configuration is carried out using a personal computer. The hazardous-area connections include cold-junction compensation and do not need to be ordered separately.

SPECIFICATION

See also common specification

Number of channels

Two

Signal source

THC types J, K, T, E, R, S, B or N to BS 60584 and XK mV input

Location of signal source

Zone 0, IIC, T4-6 hazardous area
Division 1, Group A, hazardous location

Input signal range

-75 to +75mV

Input signal span

3 to 150mV

Cold junction compensation

Automatic or selectable

Cold junction compensation error

≤ 1.0°C

Common mode rejection

120dB for 240V at 50Hz or 60Hz

Series mode rejection

40dB for 50Hz or 60Hz

Calibration accuracy (at 20°C)

(includes hysteresis, non-linearity and repeatability)

Input: ±15µV or ±0.05% of input value
(whichever is greater)

Output: ±16µA

Temperature drift (typical)

Input: ±0.003% of input value/°C

Output: ±0.6µA/°C

Safety drive on sensor burnout

Upscale, downscale, or off

Output range

4 to 20mA nominal into 300Ω max.

Maximum lead resistance

300Ω

Response time

Configurable - 500 ms default

(Accuracy at 100/200ms - contact MTL)

MTL4576-THC

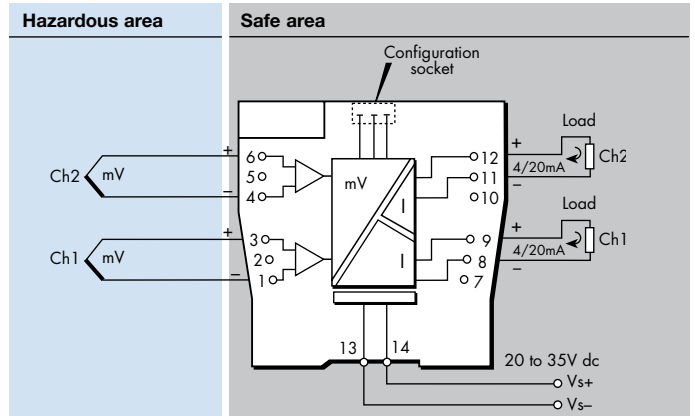

MTL5576-THC

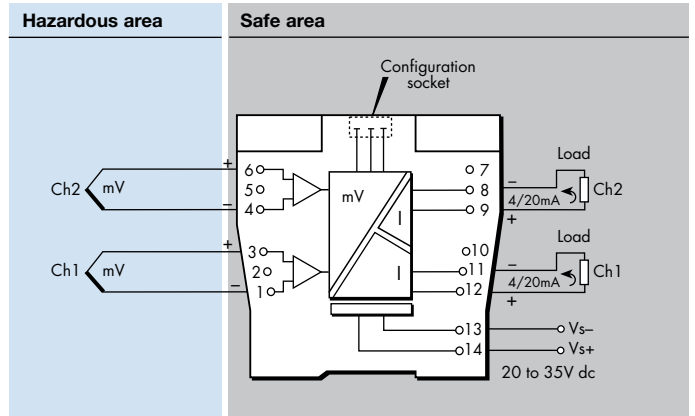

LED indicator

Green: power and status indication
Yellow: one provided for channel status
Red: alarm indication

Power requirement, Vs with 20mA signal

60mA at 24V

Power dissipation within unit with 20mA signal

1.4W at 24V

Isolation

Functional isolation channel-channel for safe and hazardous-area circuits.

Safety description

Refer to certificate for parameters. Um=253V rms or dc

Configurator

A personal computer running MTL PCS45 software with a PCL45USB serial interface.

The given data is only intended as a product description and should not be regarded as a legal warranty of properties or guarantee. In the interest of further technical developments, we reserve the right to make design changes.



EUROPE (EMEA): +44 (0)1582 723633
enquiry@mtl-inst.com

THE AMERICAS: +1 800 835 7075
csinfo@mtl-inst.com

ASIA-PACIFIC: +65 6 645 9888
sales.mtlsing@cooperindustries.com

EPSx576T Rev3 210513

MTL4581 – MTL5581

MILLIVOLT/THERMOCOUPLE ISOLATOR

for low-level signals

The MTLx581 takes a low-level dc signal from a voltage source in a hazardous area, isolates it, and passes it to a receiving instrument located in the safe area. The module is intended for use with thermocouples utilising external cold-junction compensation. A switch enables or disables the safety drive in the event of thermocouple burnout or cable breakage; a second switch permits the selection of upscale or downscale operation as appropriate.

SPECIFICATION

See also common specification

Number of channels

One

Signal source

Any dc millivolt source

Location of millivolt source

Zone 0, IIC, T4–T6 hazardous area if suitably certified
Div. 1, Group A, hazardous location

Input and output signal range

0 to $\pm 50\text{mV}$, overrange to $\pm 55\text{mV}$
Maximum lead resistance 600Ω

Output resistance

60Ω nominal

Transfer accuracy@20°C

Linearity and repeatability $< 0.05\%$ of reading or $\pm 5\mu\text{V}$, whichever is the greater

Temperature drift

$< 2\mu\text{V}/^\circ\text{C}$, maximum

Response time

Settles to within 10% of final value within $150\mu\text{s}$

Frequency response

dc to 4kHz nominal

Safety drive on THC burnout

Two switches enable or disable the safety drive and select

MTL4581

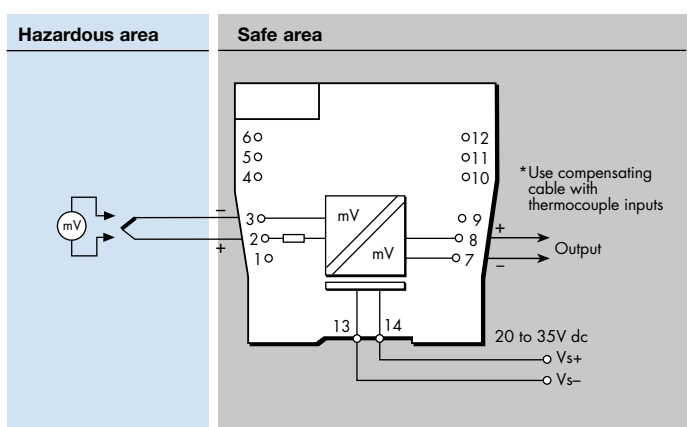

MTL5581

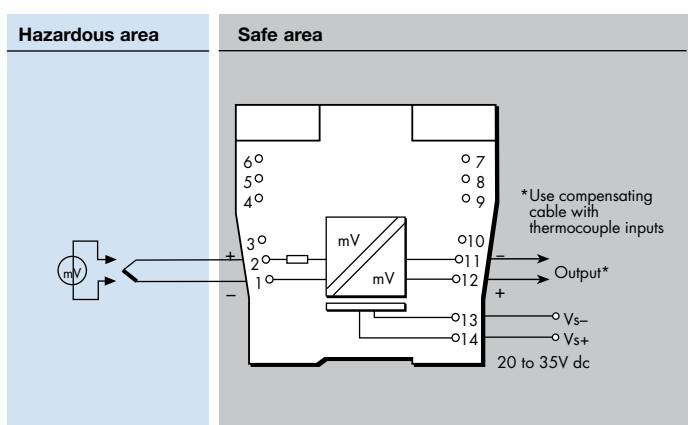

upscale or downscale operation

LED indicator

Green: power indication

Power requirement, Vs

30mA max, 20V dc to 35V dc

Power dissipation within unit

0.7W typical at 24V

0.91W at 35V

Safety description

Terminals 1 to 2

Non-energy-storing apparatus $\leq 1.5\text{V}$, $\leq 0.1\text{A}$ and $\leq 25\text{mW}$; can be connected without further certification into any IS loop with an open-circuit voltage $< 28\text{V}$

The given data is only intended as a product description and should not be regarded as a legal warranty of properties or guarantee. In the interest of further technical developments, we reserve the right to make design changes.



EUROPE (EMEA): +44 (0)1582 723633
enquiry@mtl-inst.com

THE AMERICAS: +1 800 835 7075
csinfo@mtl-inst.com

ASIA-PACIFIC: +65 6 645 9888
sales.mtlsing@cooperindustries.com

EPSx581 Rev2 200913

MTL5582

RESISTANCE ISOLATOR

to repeat RTD signals

The MTL5582 connects to a 2-, 3-, or 4-wire resistance temperature device (RTD) or other resistance located in a hazardous area, isolates it and repeats the resistance to a monitoring system in the safe area. The module is intended typically (but not exclusively) for use with Pt100 3-wire RTDs. Switches enable selection of 2-, 3-, or 4-wire RTD connection. The MTL5582 should be considered as an alternative, non-configurable MTL5575, for use in RTD applications where a resistance input is preferred or needed instead of 4/20mA. The design is notable for its ease of use and repeatability. The number of wires which can be connected on the safe-area side of the unit is independent of the number of wires which can be connected on the hazardous-area side. The module drives upscale in the case of open circuit detection. Note that this module is not suitable for use with measurement systems where the resistance input channels are multiplexed.

SPECIFICATION

See also common specification

Number of channels

One

Location of RTD

Zone 0, IIC, T4 hazardous area

Div. 1, Group A, hazardous location

Resistance source

2-, 3-, or 4-wire* RTDs to BS 1904/DIN 43760 (100 Ω at 0 $^{\circ}$ C)

*user selectable by switches (factory set for 3-wire)

Resistance range

10 Ω to 400 Ω

RTD excitation current

200 μ A nominal

Output configuration

2, 3 or 4 wires (independent of mode selected for hazardous area terminals)

Output range

10 Ω to 400 Ω (from a 100 μ A to 5mA source)

Temperature drift

\pm 10m Ω /C $^{\circ}$ typical (0.01%/C $^{\circ}$ @ 100 Ω)

Response time

To within 4% of final value within 1s

Not suitable for multiplexed input cards

Safety drive on open-circuit sensor

Upscale to 420 Ω nominal

Transfer accuracy@20 $^{\circ}$ C

<0.15 Ω at excitation current 1 - 5mA

<0.25 Ω at excitation current 0.5 - 1mA

MTL5582

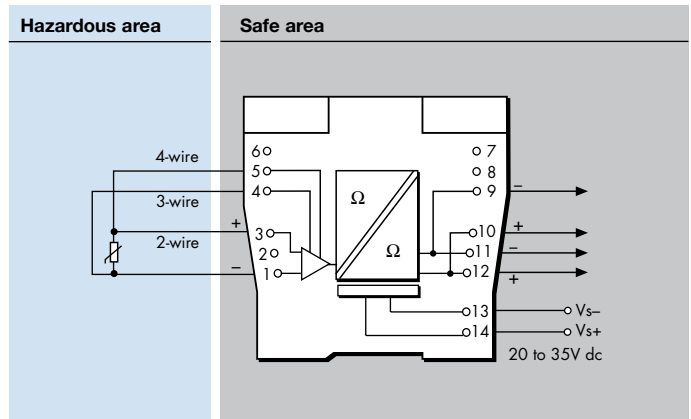

LED indicator

Green: power indication

Power requirements, Vs

33mA at 24V

35mA at 20V

28mA at 35V

Maximum power dissipation within unit

0.8W at 24V

1.0W at 35V

Safety description

Terminals 1 and 3

$U_o = 1.2V$ $I_o = 4mA$ $P_o = 1.2mW$ $U_m = 253V$ rms or dc

Non-energy-storing apparatus $\leq 1.5V$, $\leq 0.1A$, $\leq 25mW$; can

be connected without further certification into any IS loop with

an open circuit voltage < 5V.

Terminals 1 and 3 and 4 and 5

$U_o = 6.6V$ $I_o = 42mA$ $P_o = 69mW$

The given data is only intended as a product description and should not be regarded as a legal warranty of properties or guarantee. In the interest of further technical developments, we reserve the right to make design changes.



EUROPE (EMEA): +44 (0)1582 723633
enquiry@mtl-inst.com

THE AMERICAS: +1 800 835 7075
csinfo@mtl-inst.com

ASIA-PACIFIC: +65 6 645 9888
sales.mtlsing@cooperindustries.com

EPS5582 Rev3 280414

MTL4599 - MTL5599 DUMMY ISOLATOR

The primary function of the MTLx599, which can be used with all other MTLx500 Series units, is to provide termination and earthing facilities for unused cable cores from hazardous areas.

SPECIFICATION

See also common specification

Weight
60g

MTL4599

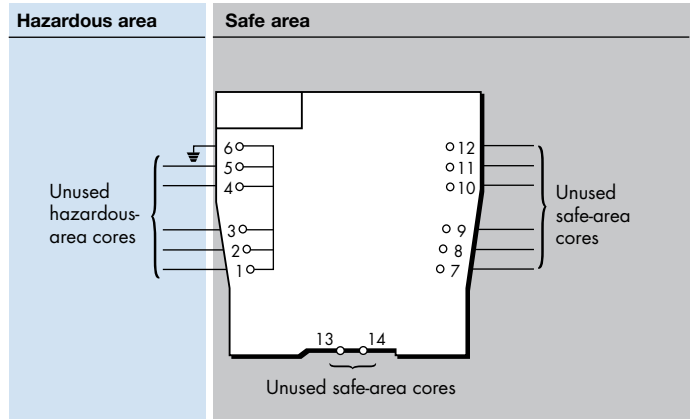

MTL5599

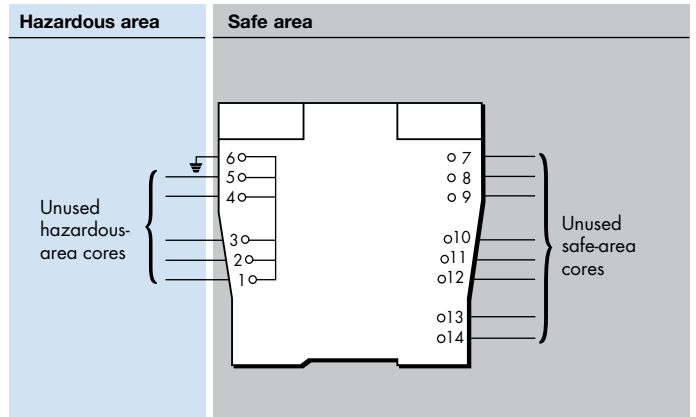

MTL4599N GENERAL PURPOSE FEED-THROUGH MODULE

The feed-through termination module allows non-IS connections to the MTL4500 backplanes. The wires from the field are connected using screw terminals. Six terminals are provided on top of the module and linked down to the multiway connector on the backplane. The terminals and cables conform to IS regulations so that non-IS and IS signals can be mixed on the same backplane.

Note: Must not be used with signals >50V or >0.25A

SPECIFICATION

See also common specification

Weight
60g

MTL4599N

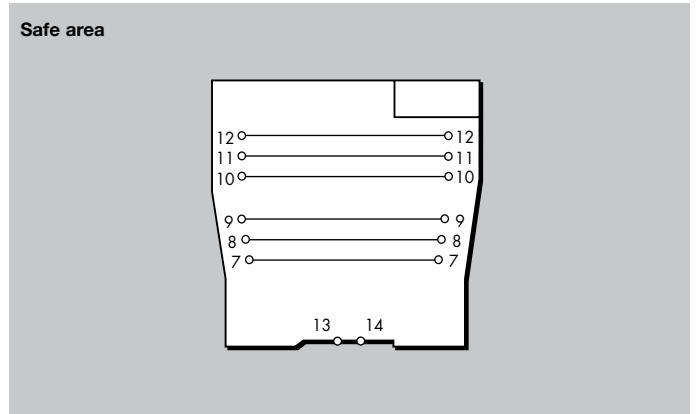

The given data is only intended as a product description and should not be regarded as a legal warranty of properties or guarantee. In the interest of further technical developments, we reserve the right to make design changes.



EUROPE (EMEA): +44 (0)1582 723633
enquiry@mtl-inst.com

THE AMERICAS: +1 800 835 7075
csinfo@mtl-inst.com

ASIA-PACIFIC: +65 6 645 9888
sales.mtising@cooperindustries.com

EPSx599/N Rev3 200913

MTL4500 - MTL5500 SERIES COMMON SPECIFICATIONS

Please go to our website at www.mtl-inst.com for the latest information regarding safety approvals, certificates and entity parameters.

Connectors

Each unit is supplied with signal connectors, as applicable. When using crimp ferrules for the hazardous or non-hazardous (safe) signal connectors the metal tube length should be 12mm and the wire trim length 14mm.

Isolation

250V rms, tested at 1500V rms minimum, between safe- and hazardous-area terminals.
MTL4500: 50V between safe-area circuits and power supply
MTL5500: 250V rms between safe-area circuits and power supply

Supply voltage

20 – 35V dc

Location of units

Safe area

Terminals

Accepts conductors of up to 2.5mm² stranded or single-core

Mounting

MTL4500

MTL4500 series backplanes

MTL5500

T-section 35mm DIN rail (7.5 or 15mm) to EN 50022

Ambient temperature limits

-20 to +60°C (-6 to +140°F) operating
-40 to +80°C (-40 to +176°F) storage

Humidity

5 to 95% relative humidity

Weight

Approximate (except where indicated)

MTL4500	140g
MTL5500	150g

EMC

To EN61326 and NE21*

* For 20ms power interruption compliance, a suitable power supply must be used.

HART® is a registered trademark of HART Communication Foundation

DIMENSIONS (MM)

MTL4500

Optional TH5000 tag holder for individual isolator identification.
Accepts tag label 25 x 12.5 ±0.5mm, 0.2mm thick

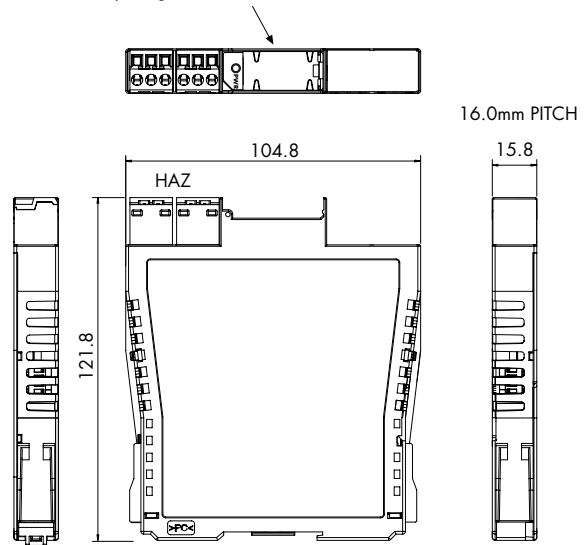

MTL5500

Optional TH5000 tag holder for individual isolator identification.
Accepts tag label 25 x 12.5 ±0.5mm, 0.2mm thick

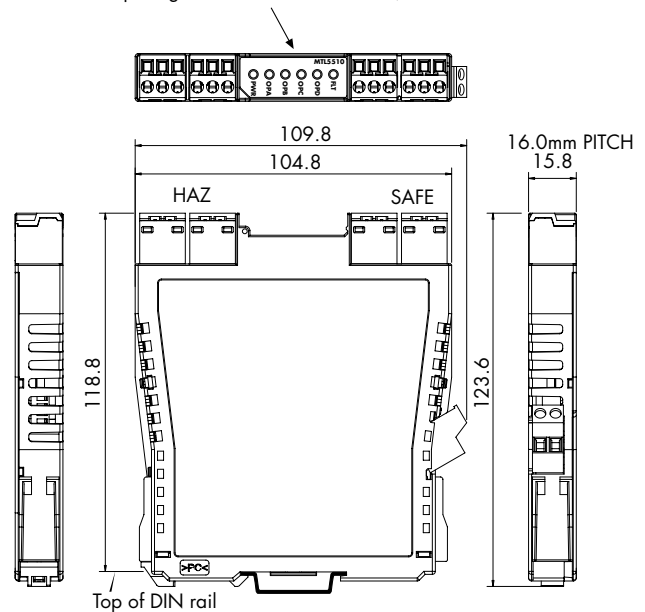

The given data is only intended as a product description and should not be regarded as a legal warranty of properties or guarantee. In the interest of further technical developments, we reserve the right to make design changes.



EUROPE (EMEA): +44 (0)1582 723633
enquiry@mtl-inst.com

THE AMERICAS: +1 800 835 7075
csinfo@mtl-inst.com

ASIA-PACIFIC: +65 6 645 9888
sales.mtlsing@cooperindustries.com

EPSx5CS Rev3 200913

MPA5500 A.C. POWER ADAPTOR

The MPA5500 enables any MTL5500 Series module that is normally powered from a nominal 24V DC supply (i.e. those that are not loop-powered) to be powered from a high-voltage AC supply.

It plugs into the power socket (terminals 13 and 14) of an MTL5500 module and clips securely onto the module housing. The 25V DC power output from the adaptor is sufficient to supply a single module and can be connected to any normal AC power source.

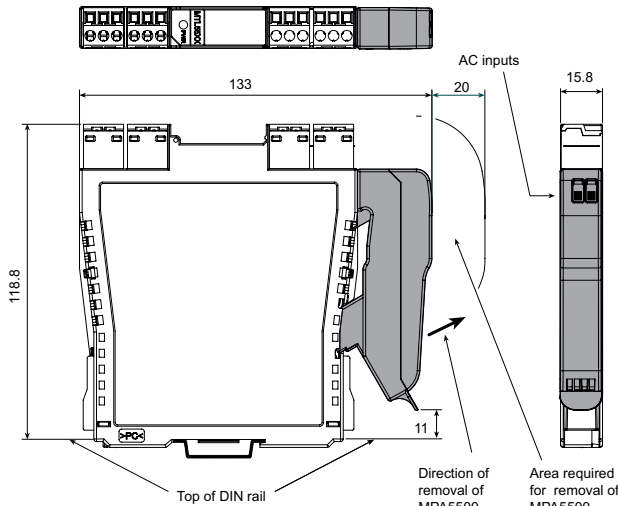

SPECIFICATION

Input voltage

85 – 265V AC, (45–65Hz)

Efficiency

71% typ. at 230V AC

Power dissipation

1.2W typ at 230V AC.

Input terminals

Cage-clamp terminals accommodating conductors up to 1.5mm² stranded or 16AWG single-core

Input protection

internal fuse, not user serviceable

Output voltage

25Vdc ± 10%

Output current

120mA at 25V

Ambient temperature

Operating: –20 to +60°C

Storage: –40 to +80°C

Mounting

Plugs into and clips onto MTL5500 Series I/O module
It is not for use with any equipment other than MTL5500.

Humidity

5 to 95% relative humidity

Mechanical

Ingress Protection: IP20

Material: polycarbonate

Weight: 28g approx.

Standards compliance

EN 61326, EN 61010

PCS45/PCL45USB CONFIGURATOR FOR MTL CONVERTERS

The PCS45/PCL45USB configurator allows MTL converters to be configured from a standard PC running a Microsoft® Windows® operating system. It comprises PC software, provided on a CD (PCS45), and an ATEX certified interfacing link (PCL45USB). Converters can be configured from the safe area, while on-line, and configurations can be saved to disk and printed out when required. It is suitable for use with MTL4000, MTL4500, MTL5000 and MTL5500 series products.

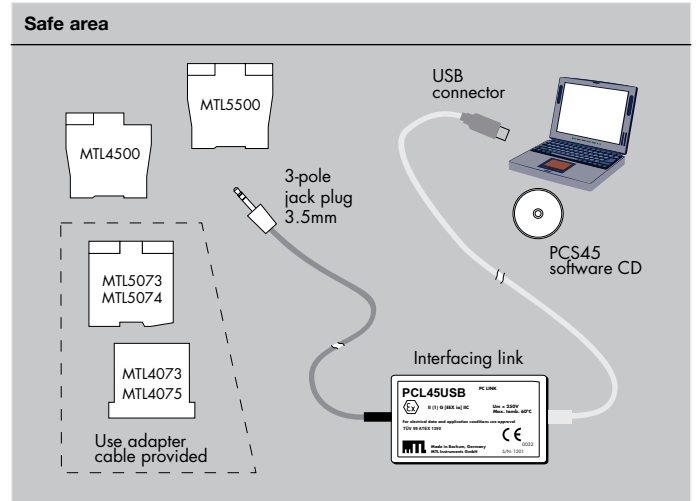

SPECIFICATION

PCL45USB hardware

Location

Safe area

Connections

PC side: USB B(F) socket

Converter side: cable with 3.5mm jackplug, 3-pole for MTL4500 and MTL5500 series converters. An adapter cable is provided for other earlier MTL converters.

Cable lengths

Converter side (fitted): 1.5m

USB cable A(M) to B(M) (supplied): 2m

Ambient temperature limits

–10°C to +60°C operating

–20°C to +70°C storage

Humidity

5 to 95% relative humidity (non-condensing)

Weight

200g

PCS45 Configuration software

Compatible with Windows 2000, Windows XP or Windows 7

Consult MTL for operation with any other operating system, e.g. Windows Vista™.

Software medium

PCS45 supplied on CD

Updates are available at www.mtl-inst.com

Recommended minimum PC configuration

Microsoft Windows 2000, Windows XP or Windows 7

20MB of available hard disc space

CD ROM drive

Available USB port

Printer (local or network)

The given data is only intended as a product description and should not be regarded as a legal warranty of properties or guarantee. In the interest of further technical developments, we reserve the right to make design changes.



EUROPE (EMEA): +44 (0)1582 723633
enquiry@mtl-inst.com

THE AMERICAS: +1 800 835 7075
csinfo@mtl-inst.com

ASIA-PACIFIC: +65 6 645 9888
sales.mtl@cooperindustries.com

EPS45/5500 Rev3 200913

MTL5991

24V DC POWER SUPPLY

A DIN-rail mounted unit for locations where a dc supply is not readily available. The wide input power supply range makes this unit universally applicable and the 24V dc, 2A output will drive a useful number of MTL5000 and MTL5500 series modules.

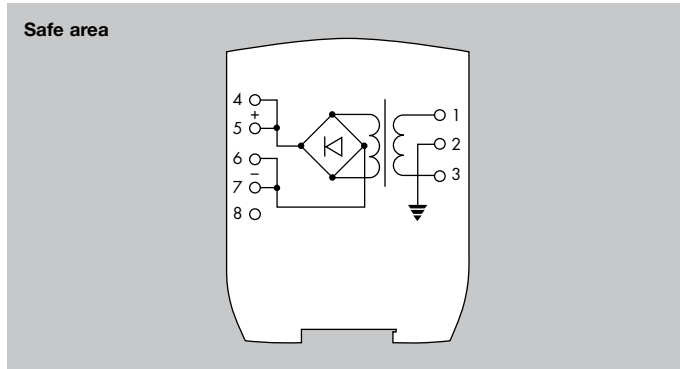

SPECIFICATION

Power supply

85 to 264V ac 47 to 63Hz

Power dissipation within unit

7.2W @ 2A

Mounting

35mm DIN (top hat) rail

Output voltage

24V dc nom (23.64 min/24.36 max)

Output current

2A maximum (1.7A with <105V ac input)

LED indicators

Green: Power indication

Weight

310g

Ambient temperature

Operating temperature -10°C to +50°C

Storage temperature -40°C to +85°C

Terminals

Cage clamp type accommodating conductors up to 2.5mm², stranded or single-core

Note: Segregation between hazardous and safe area wiring must be maintained.

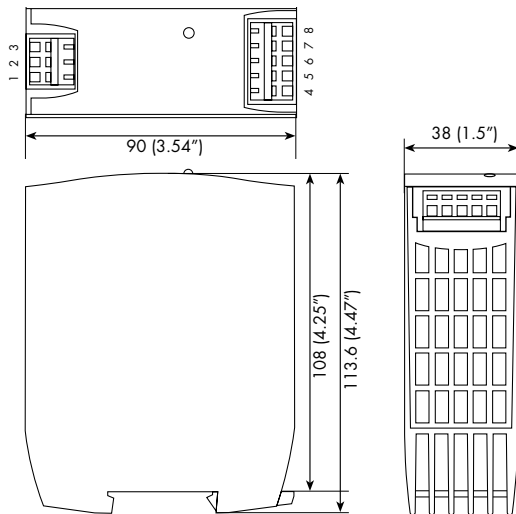

MTL5500 SERIES

POWERBUS KITS

PB - 8T,16T,24T,32T

A quick and easy way to distribute DC power to MTL5500 Series modules. Each powerbus kit includes 4 single ferrules, 4 twin ferrules and 2 insulation displacement connectors (Scotchlok).

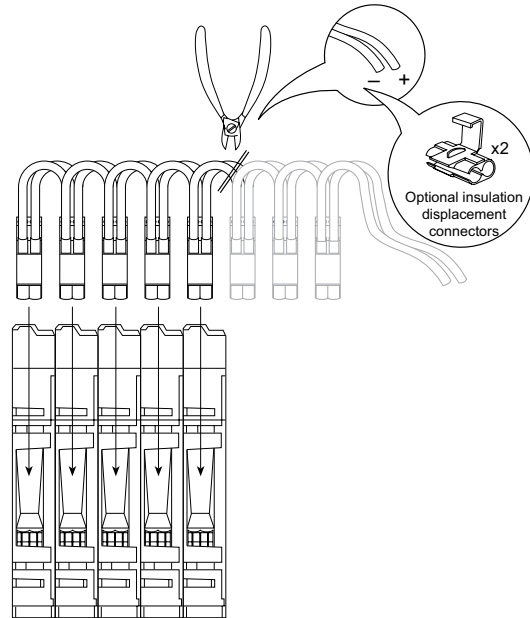

SPECIFICATION

Available in 4 different lengths:

PB - 8T	= 8 connectors and loops
PB - 16T	= 16 connectors and loops
PB - 24T	= 24 connectors and loops
PB - 32T	= 32 connectors and loops

Insulation material :

PVC

Conductor :

24 strands of 0.2mm dia (0.75mm²) standard copper

Insulation thickness :

0.5 to 0.8 mm

Current rating :

12A max

Operating temperature range :

-20°C to +60°C

Max voltage drop on 32 modules drawing 130mA max :

0.5V

CHOOSING A POWERBUS KIT

Choose a powerbus where the number of power plugs is greater than or equal to the number of isolators to be powered and if necessary cut the powerbus to the required number of terminations.

Note: To reduce the risk of excessive voltage drop or overcurrent do not connect powerbuses in series.

The given data is only intended as a product description and should not be regarded as a legal warranty of properties or guarantee. In the interest of further technical developments, we reserve the right to make design changes.



EUROPE (EMEA): +44 (0)1582 723633
enquiry@mtl-inst.com

THE AMERICAS: +1 800 835 7075
csinfo@mtl-inst.com

ASIA-PACIFIC: +65 6 645 9888
sales.mtlsing@cooperindustries.com

EPS45/5500 Rev3 210513

MTL5500 SERIES ENCLOSURES

DIMENSIONS (mm) AND MOUNTING

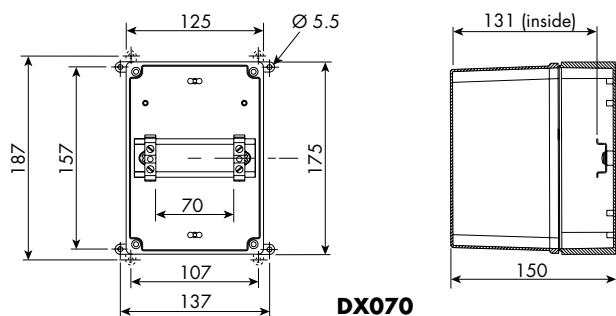

DX070

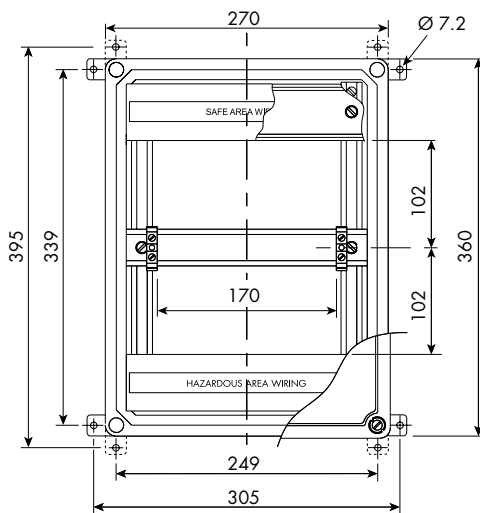

DX170

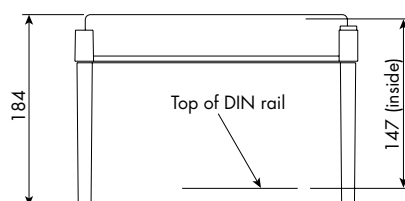

SPECIFICATION

Construction

- Glass reinforced polycarbonate base - DX070
- Glass reinforced polyester base - DX170
- Transparent polycarbonate lid

Protection

- Dust-tight and water-jet proof to IEC529:IP65

Lid fixing

- Captive fixing screws

Weight (excluding barriers/isolators) kg

- DX070** 0.8
- DX170** 2.6

Items provided

- DIN rail - fitted
- ETL7000 Earth terminals (2 x) - fitted
- "Take care IS" front adhesive label
- Cable trunking (except DX070)

Note: Isolators are not included.

Mounting

- Wall fixing lugs provided. For further details refer to INM5500.

Tagging and earth rail

- Accommodates MTL5500 Series accessories.

Permitted location

- Safe (non-hazardous) area

Note: N. America/Canada - Enclosures are rated NEMA 4X so can be used in Class 1, Division 2 (gases) location, but check with local requirements and ensure all cable entries also conform. Additional warning label will be required on or near the enclosure, see installation details. Not suitable for Class II or III, Division 2 hazardous locations.

Approximate capacities (on DIN rail between earth terminals)

** Use these figures when IMB57 mounting blocks for tagging/earth are included.*

	Number of MTL5500 isolators	
	DX070	4
DX170	10	(8)*

Ambient temperature limits

Dependent on units fitted. See instruction manual INM5500.

The given data is only intended as a product description and should not be regarded as a legal warranty of properties or guarantee. In the interest of further technical developments, we reserve the right to make design changes.



EUROPE (EMEA): +44 (0)1582 723633
enquiry@mtl-inst.com

THE AMERICAS: +1 800 835 7075
csinfo@mtl-inst.com

ASIA-PACIFIC: +65 6 645 9888
sales.mtlsing@cooperindustries.com

EPS45/5500 Rev3 200913

MTL5500 SERIES ACCESSORIES

MTL5500 Series isolators mount quickly and easily onto standard DIN rail. A comprehensive range of accessories simplifies earthing and tagging arrangements.

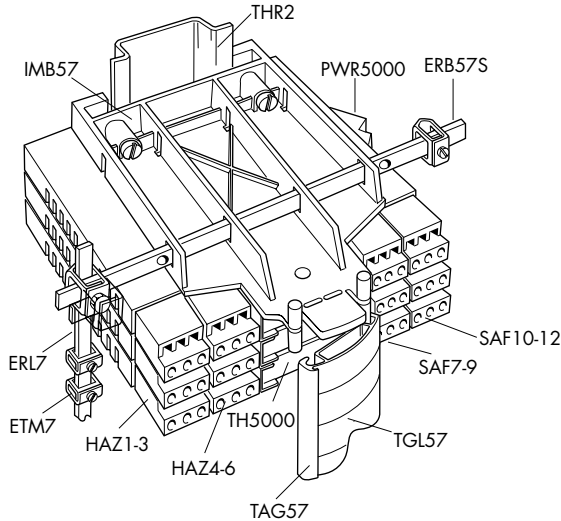

MOUNTING

THR2 DIN rail, 1m length

DIN rail to EN50022; BS5584; DIN46277

MS010 DIN rail module spacer, 10mm, pack of 5

Grey spacer, one required between each MTL5533 or MTL5995-PS and any adjacent module on a DIN rail, to provide 10mm air-circulation space between modules

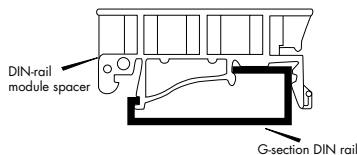

EARTH RAILS AND TAG STRIP

IMB57 Insulating mounting block

One required at each end of a tagging strip/earth rail. Suitable for low-profile (7.5mm) and high-profile (15mm) symmetrical DIN rail.

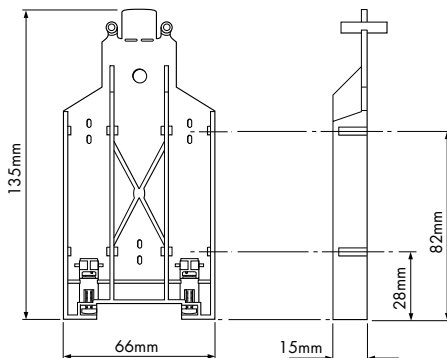

ERB57S Earth-rail bracket, straight

Nickel-plated; supplied with two push fasteners, one (14mm, 35mm²) earth-rail clamp and one (10mm, 16mm²) earth clamp.

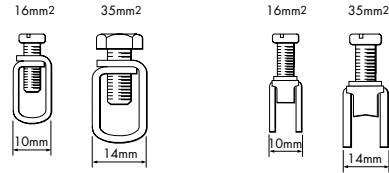
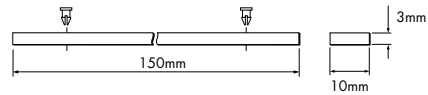

ERL7 Earth rail, 1m length

Nickel-plated; may be cut to length.



ETM7 Earth terminal, bag of 50

For terminating cable screens and 0V returns on the ERL7 earth rail. For cables ≤ 4mm². Exact dimension dependent on manufacturer.

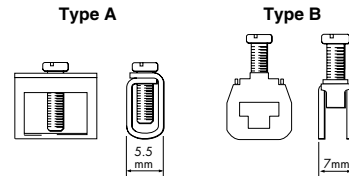

TAG57 Tagging strip, 1m length

Cut to size. Supplied with tagging strip label suitable for MTL5000 or MTL5500 modules.

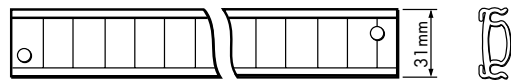

TGL57 Tagging strip labels, set of 10 x 0.5m

Spares replacement, for use with TAG57 tagging strip. Suitable for MTL5000 or MTL5500 modules.

INDIVIDUAL ISOLATOR IDENTIFICATION

TH5000 tag holders

Each isolator may be fitted with a clear plastic tag holder, as shown below. Order TH5000, pack of 20.

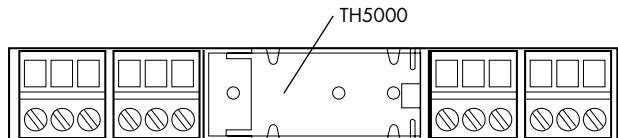

CONNECTORS

Each MTL5500 unit is supplied with signal and power connectors, as applicable.

Spares replacement connectors are available separately; see ordering information.

See also
'MTL5500 Series powerbus kits'

The given data is only intended as a product description and should not be regarded as a legal warranty of properties or guarantee. In the interest of further technical developments, we reserve the right to make design changes.



EUROPE (EMEA): +44 (0)1582 723633
enquiry@mtl-inst.com

THE AMERICAS: +1 800 835 7075
csinfo@mtl-inst.com

ASIA-PACIFIC: +65 6 645 9888
sales.mtlsing@cooperindustries.com

EPS45/5500 Rev3 200913

CUSTOM, STANDARD AND UNIVERSAL BACKPLANES FOR EASY DCS INTEGRATION

- Total flexibility
- Reduce wiring
- Simplify installation
- Special functions
- Signal conditioning
- HART® integration

The MTL4500 Series backplanes, enclosures and other accessories provide comprehensive, flexible and remarkably compact mounting facilities for system vendors, original equipment manufacturers and end users alike.

CUSTOMISED BACKPLANES

MTL provides a complete design and manufacturing service for customised backplanes. Customised backplanes give the vendors and users of process control and safety systems the opportunity to integrate MTL4500/HART® modules directly into their system architecture. As there are no hazardous-area circuits on the backplanes, customised versions can be produced without the need for IS certification, so simplifying design and lowering costs.

UNIVERSAL CUSTOM BACKPLANES

The 'universal' backplane allows a fast and economic approach to providing a custom interface. Where tight time schedules exist, the backplane can be installed to allow the panel building and wiring to be completed. The customised adapter card can then be plugged in at any time up to integrated test.

ADAPTER CARDS

Adapter cards already exist for many of the DCS companies. In addition there is a range of general purpose cards that offer reduced wiring for use with specific MTL modules. These are also available in left- and right-hand versions to ease panel wiring.

STANDARD MTL BACKPLANES

Standard MTL backplanes are available to accommodate 4, 8, 16, or 24 modules using screw-clamp connectors for the safe-area circuits. On an individual backplane, any module can be plugged into any position and module types can be mixed. For 8-, 16- and 24-way backplanes, screw-clamp connectors which plug into the backplanes provide primary and secondary 24V dc power supplies. Power to several 8- or 16-way backplanes can be interconnected to reduce and simplify wiring – see instruction manual INM4500 for details.

MTL CPS STANDARD BACKPLANES

Backplane model no.	Number of modules	Safe-area connections	MOUNTING KITS			ACCESSORIES		
			Surface	DIN-rail (T or G)	19-inch rack	Earth-rail kit	Tagging strip kit	Spare fuse pack
CPS04	4	Screw-clamp	SMS01	DMK01	–	–	–	FUS1.0ATE5
CPS08	8	Screw-clamp	SMS01	DMK01	–	ERK08	TSK08	FUS1.0ATE5
CPS16	16	Screw-clamp	SMS01	DMK01	–	ERK16	TSK16	FUS2.0ATE5 or FUS2.5ATE5
CPS24	24	Screw-clamp	SMS01	DMK01	HMP24	–	TSK24	FUS4.0ATE5

The given data is only intended as a product description and should not be regarded as a legal warranty of properties or guarantee. In the interest of further technical developments, we reserve the right to make design changes.



OPTIONAL ACCESSORIES

Optional accessories include colour coded tagging strip kits for all three sizes of backplane and earth rail kits for 8 and 16-way versions. Mounting accessories are available for surface (all backplanes), T-section and G-section DIN-rail (8- and 16-way versions), and a horizontal plate for mounting 24-way backplanes in 19-inch racks.

WEATHERPROOF ENCLOSURES

Weatherproof enclosures are available for applications where separate safe-area enclosures are required for backplanes with modules. Available to accommodate one 4-way or one 8-way backplane, they are manufactured from GRP giving protection against dust and water to IEC529:IP65. The lids are made from transparent high-strength polycarbonate so that LEDs, switches, etc. on the tops of the modules are easy to see.

DCS VENDORS/SYSTEMS SUPPORTED:

ABB Automation
S100, INF190, S800

Bently-Nevada

Emerson
M Series, S Series

Foxboro
IA FBM & FBM2xx

HIMA
HIMax

Honeywell
PMIO, C200, C300, UPIO

Honeywell-SMS
Safety Manager, USIO

ICS
Triplex, Plantguard

Rockwell Automation

Schneider
Modicon

Siemens
ET200, S7

Triconex
Tricon, Trident

Yokogawa
Centum R3, VP, Prosafe RS, CS3000



EUROPE (EMEA): +44 (0)1582 723633
enquiry@mtl-inst.com

THE AMERICAS: +1 800 835 7075
csinfo@mtl-inst.com

ASIA-PACIFIC: +65 6 645 9888
sales.mtlsing@cooperindustries.com

EPS45/5500 Rev3 200913

CPS BACKPLANE DIMENSIONS (mm)

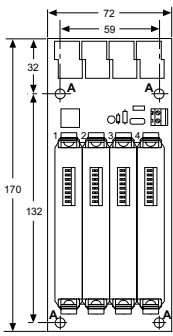

CPS04
CPS04-CC

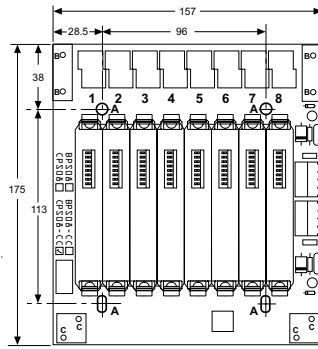

CPS08
CPS08-CC

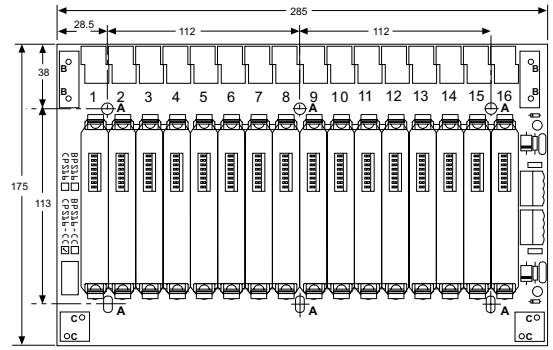

CPS16
CPS16-CC

-CC - Conformal Coating

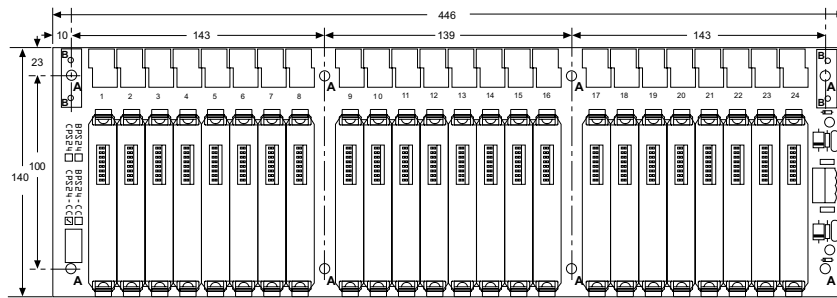

CPS24

Power requirements, Vs

21V dc to 35V dc through plug-in connectors

Safe-area connections

CPS: 2.5mm² screw-clamp terminals – 6 positions per module

Weight (without modules or accessories)

CPS04:	96g
CPS08:	225g
CPS16:	419g
CPS24:	592g

HMP24 - 19" RACK MOUNTING PLATE FOR CPS24

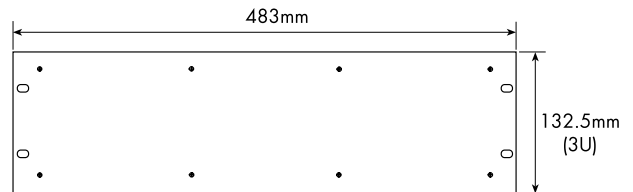

BACKPLANE ACCESSORIES

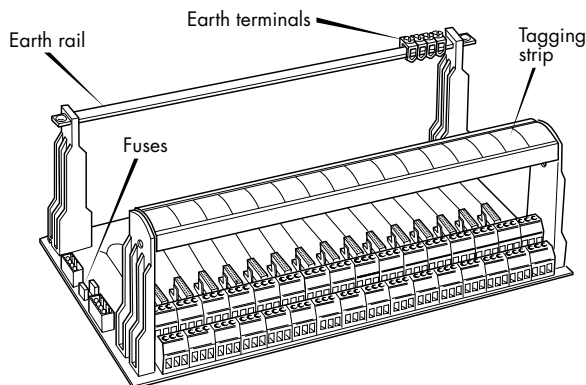

SCK45 - backplane clips



10 x strip of four

MCK45 - backplane clips



16 x strip of two

The given data is only intended as a product description and should not be regarded as a legal warranty of properties or guarantee. In the interest of further technical developments, we reserve the right to make design changes.



EUROPE (EMEA): +44 (0)1582 723633
enquiry@mtl-inst.com

THE AMERICAS: +1 800 835 7075
csinfo@mtl-inst.com

ASIA-PACIFIC: +65 6 645 9888
sales.mtsing@cooperindustries.com

EPS45/5500 Rev3 201113

CUSTOM BACKPLANES

MTL4500 series backplanes can be customised for specific applications and customer's requirements. All the signals on the backplane are 'safe-area' so custom designs are possible without the need for certification. MTL offers a fast and efficient customising service upon request.

Many installations can benefit from the use of existing custom solutions. These provide reduced system wiring, modularisation of the channels to match the IO card. In addition diagnostics, such as line fault detection, can be grouped prior to connection into the system.

Remote cable connections:

In addition to the many DCS solutions, listed on a previous page, are backplanes and cables that are ideal when the isolators are mounted in remote cabinets and the signals need to be returned to the system via a multicore cable.

CP-DYN SERIES

FTA	Size	Function	MTL modules
CP-DYNB-AIO	B	16ch analogue input /output	MTL4541, 4546Y, 4575
CP-DYNB-AI250	B	16ch analogue input	MTL4541, 4575
CP-DYNA-2AIO	A	16ch analogue input / output	MTL4544, 4549Y
CP-DYNB-DI	B	16ch digital input	MTL4511, 4514
CP-DYNB-DILF	B	16ch digital input with LFD	MTL4514
CP-DYNB-2DI	B	32ch digital input	MTL4513, 4516, 4517
CP-DYNB-4DI	B	48ch digital input	MTL4510
CP-DYNB-DO	B	16ch digital output	MTL4521, 4521L

DESCRIPTION

For use when the IS interfaces are remotely mounted from the control system, this series of cable connected FTAs provide a simple plug/socket connection method for IS field devices to any control system. The FTAs come fitted with mounting pillars for surface mounting or may be used with the DIN rail mounting kit to mount on a single DIN rail.

The cable connections between the system card and the FTA use the Tyco Dynamic series of connector which provide a reliable and high density solution.



CABLES

All FTAs use the Tyco 20 pin Dynamic series of connectors. Cables are fitted with a mating connector and free ends the other, for connection to the system card.

Cable ordering code

CABDYN20-0.5	0.5m cable
CABDYN20-1	1.0m
CABDYN20-2	2.0m
CABDYN20-3	3.0m
CABDYN20-5	5.0m
CABDYN20-8	8.0m
CABDYN20-10	10m
CABDYN20-15	15m
CABDYN20-20	20m
CABDYN20-25	25m
CABDYN20-30	30m

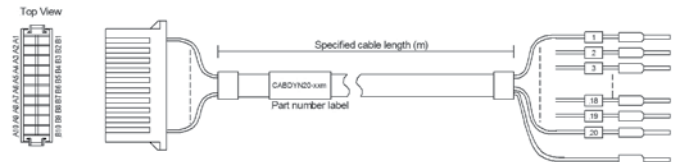

The given data is only intended as a product description and should not be regarded as a legal warranty of properties or guarantee. In the interest of further technical developments, we reserve the right to make design changes.



EUROPE (EMEA): +44 (0)1582 723633
enquiry@mtl-inst.com

THE AMERICAS: +1 800 835 7075
csinfo@mtl-inst.com

ASIA-PACIFIC: +65 6 645 9888
sales.mtlsing@cooperindustries.com

CP-DYN DIMENSIONS

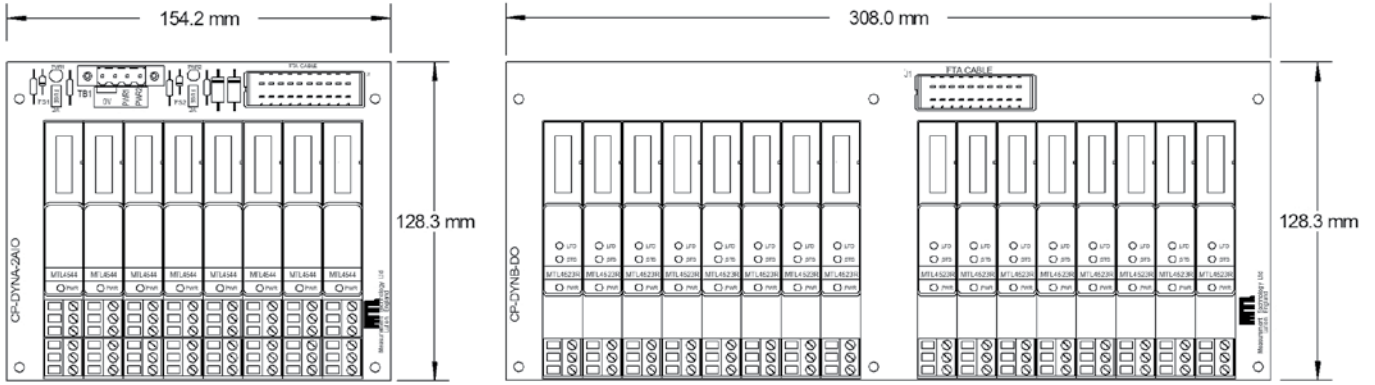

For full technical details please contact MTL.

CPELCO SERIES

A range of dedicated backplanes to interface with MTL4500 series intrinsically safe isolator modules and the MTL HART maintenance system products. The backplanes offer a standard Elco interface connector for use in systems where the IS interfaces are remote from the DCS.

Backplane	Function	MTL module	Cable
CPM08-2AIO	16ch AI 4-20mA	MTL4544/4576/4549Y x 8	Elco38 x 1
CPM08-2AV	16ch AI 1-5V	MTL4544/4576 x 8	Elco38 x 1
CPM16-AIO	16ch AIO 4-20mA	MTL4541/4575/4546Y	Elco38 x 1
CPM16-2AIO	32ch AI 4-20mA	MTL4544/4576/4549Y x 16	Elco38 x 2
CPM16-2AV	32ch AI 1-5V	MTL4544/4576 x 16	Elco38 x 2
CPM08-DDI	16ch DI	MTL4513/4516	Elco38 x 1
CPM16-DO	16ch DO	MTL4524/4523R	Elco38 x 1
CGM08-DO	8ch DO	MTL4521/4521L (loop powered)	Elco38 x 1

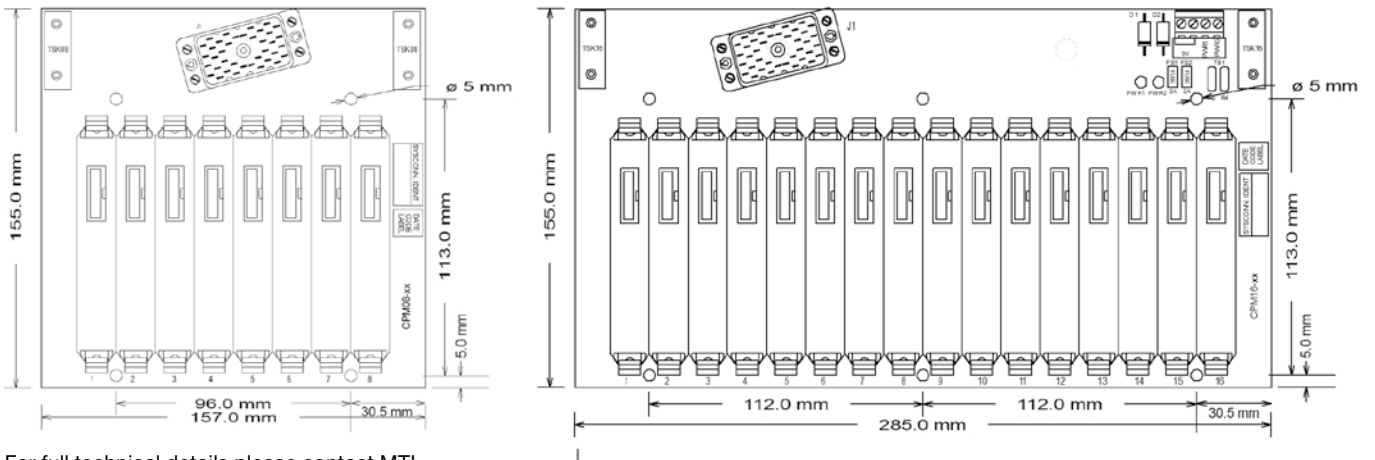

For full technical details please contact MTL.

ANALOGUE SIGNAL REPEAT

CPS04-AIREP backplane may be used to generate a repeat output from a single transmitter source. This includes high integrity loops in general purpose applications. The MTL4641 is used to generate an isolated repeat signal from an existing 4-20mA loop.

CPS04-2AIO, 8 channel backplane, is used with IS signals with 2 channel AI or AO modules or with the MTL4544D to generate 4 inputs with repeat outputs.

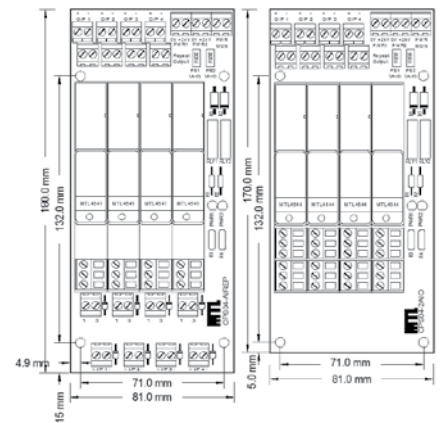

EUROPE (EMEA): +44 (0)1582 723633
enquiry@mtl-inst.com

THE AMERICAS: +1 800 835 7075
csinfo@mtl-inst.com

ASIA-PACIFIC: +65 6 645 9888
sales.mtlsing@cooperindustries.com

ORDERING INFORMATION



MTL4500/5500 Series isolators

Specify part number: eg, **MTL4511**, **MTL5575**

Individual isolator identification

TH5000 Tag holder (Pack of 20)

Connectors - MTL4500 & MTL5500

HAZ1-3 Hazardous-area plug, terminals 1, 2 and 3

HAZ4-6 Hazardous-area plug, terminals 4, 5 and 6

HAZ-CJC Hazardous-area plug, terminals 1 and 3 with cold-junction sensor

HAZ-CJC2 Hazardous-area plug, terminals 4 and 6 with cold-junction sensor

SAF1-3 Safe-area plug, terminals 1, 2 and 3

SAF4-6 Safe-area plug, terminals 4, 5 and 6

Connectors - MTL5500 only

SAF7-9 Safe-area plug, terminals 7, 8 and 9

SAF10-12 Safe-area plug, terminals 10, 11 and 12

PWR5000 Power connector, terminals 13 and 14

PowerBus - MTL5500 only

PB-8T Powerbus Kit for up to 8 isolators

PB-16T Powerbus Kit for up to 16 isolators

PB-24T Powerbus Kit for up to 24 isolators

PB-32T Powerbus Kit for up to 32 isolators

MTL5500 Mounting accessories

THR2 1m length of DIN rail to EN 50022; BS 5584; DIN 46277

MS010 DIN-rail module spacer, 10mm (pack of 5)

MTL5500 Earth-rail and tag strip accessories

IMB57 Insulating mounting block

ERB57S Earth-rail bracket, straight

ERL7 Earth-rail, 1m length

ETM7 Earth terminal, bag of 50

TAG57 Tagging strip, 1m length

TGL57 Tagging strip labels, set of 10 x 0.5m



MTL5500 Enclosures

DX070 Enclosure for MTL5500 x 4

DX170 Enclosure for MTL5500 x 10



MTL4500 Standard Backplanes

CPS04 4-way backplane screw-clamp connector

CPS08 8-way backplane screw-clamp connector

CPS16 16-way backplane screw-clamp connector

CPS24 24-way backplane screw-clamp connector

MTL4500 Custom Backplanes

Contact MTL for options and advice



MTL4500 Backplane mounting accessories

DMK01 DIN-rail mounting kit, T- or G-section (pack of 40)

8-way backplanes require 4,
16-way backplanes require 6

SMS01 Surface mounting kit (pack of 40)
4- and 8-way backplanes require 4,
16-way backplanes require 6,
24-way backplanes require 8

HMP24 Horizontal mounting plate and screws for 19-inch rack mounting
24-way backplanes only

BMK08 Mounting kit for one 4- or 8-way backplane

BMK16 Mounting kit for one 16-way backplane

MTL4500 Backplane accessories

ERK08 Earth rail kit for CPS08 backplane

ERK16 Earth rail kit for CPS16 backplane

TSK08 Tagging strip kit for CPS08 backplane

TSK16 Tagging strip kit for CPS16 backplane

TSK24 Tagging strip kit for CPS24 backplane

FUS1.0ATE5 Fuse kit, 1.0A (pack of 10)

FUS2.0ATE5 Fuse kit, 2.0A (pack of 10)

FUS2.5ATE5 Fuse kit, 2.5A (pack of 10)

FUS4.0ATE5 Fuse kit, 4.0A (pack of 10)

MCK45 MTL4000 backplane conversion kit (16 clip pairs per pack)

SCK45 Module 4-clip strips (10 strips + 40 rivets per pack)

MPL01 Module position label (blank) (50 per pack)

MCC45 Module backplane connector cover (pack of 50)



Literature

INM5500 MTL5500 Series instruction manual

INM4500 MTL4500 Series instruction manual

Configurator and software

PCL45USB Configurator, PC interface and software

PCS45 PC software

Please go to our website at www.mtl-inst.com for the latest information regarding safety approvals, certificates and entity parameters.

The given data is only intended as a product description and should not be regarded as a legal warranty of properties or guarantee. In the interest of further technical developments, we reserve the right to make design changes.



EUROPE (EMEA): +44 (0)1582 723633
enquiry@mtl-inst.com

THE AMERICAS: +1 800 835 7075
csinfo@mtl-inst.com

ASIA-PACIFIC: +65 6 645 9888
sales.mtlsing@cooperindustries.com

EPS45/5500 Rev3 201113