

**N-Channel Enhancement Mode MOSFET**

# MTN7002CKN3

<b>BV<sub>DSS</sub></b>	<b>60V</b>
<b>I<sub>D</sub>@V<sub>GS</sub>=10V, T<sub>A</sub>=25°C</b>	<b>0.7A</b>
<b>R<sub>DSON</sub>@V<sub>GS</sub>=10V, I<sub>D</sub>=700mA</b>	<b>0.27Ω (typ)</b>
<b>R<sub>DSON</sub>@V<sub>GS</sub>=4.5V, I<sub>D</sub>=500mA</b>	<b>0.71Ω (typ)</b>

**Features**

- ESD protected gate, ≥3kV
- High speed switching
- Pb-free lead plating and halogen-free package
- Easily designed drive circuits
- Low-voltage drive
- Easy to use in parallel

**Symbol**

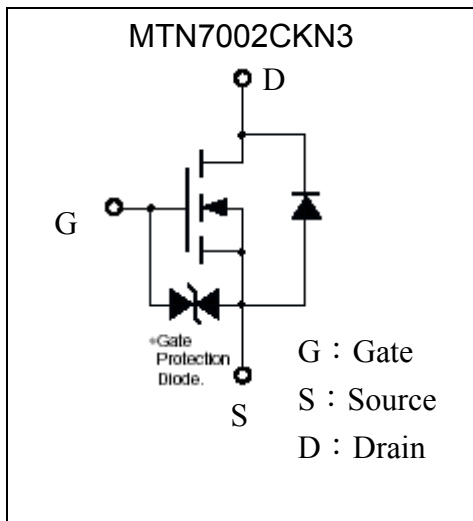

**Outline**

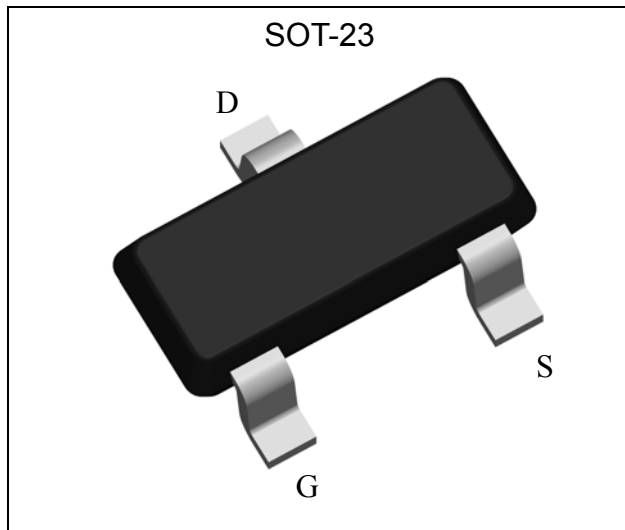

**Ordering Information**

Device	Package	Shipping
MTN7002CKN3-0-T1-G	SOT-23 (Pb-free lead plating and halogen-free package)	3000 pcs / tape & reel

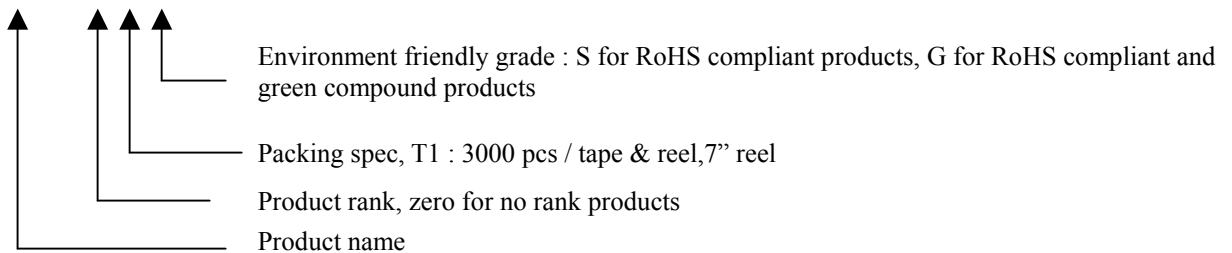



**Absolute Maximum Ratings (Ta=25°C)**

Parameter	Symbol	Limits	Unit
Drain-Source Voltage	V <sub>DSS</sub>	60	V
Gate-Source Voltage	V <sub>GSS</sub>	±20	
Continuous Drain Current @V <sub>GS</sub> =10V, T <sub>A</sub> =25°C	I <sub>D</sub>	700	mA
Continuous Drain Current @V <sub>GS</sub> =10V, T <sub>A</sub> =70°C		560	
Pulsed Drain Current	I <sub>DM</sub>	2900 *1	
Total Power Dissipation	P <sub>D</sub>	350 *2	mW
ESD susceptibility	V <sub>ESD</sub>	3000 *3	V
Operating Junction Temperature Range	T <sub>j</sub>	-55~+150	°C
Storage Temperature Range	T <sub>stg</sub>	-55~+150	

**Thermal Characteristics**

Parameter	Symbol	Value	Unit
Thermal Resistance, Junction to Ambient	R <sub>θJA</sub>	357 *2	°C/W

Note : \*1. Pulse Width ≤ 300μs, Duty cycle ≤ 2%

\*2. When the device is mounted on a glass epoxy board with area measuring 1×0.75×0.62 inch

\*3. Human body model, 1.5kΩ in series with 100pF

**Electrical Characteristics (Ta=25°C)**

Symbol	Min.	Typ.	Max.	Unit	Test Conditions
<b>Static</b>					
BV <sub>DSS</sub> *	60	-	-	V	V <sub>GS</sub> =0V, I <sub>D</sub> =250μA
V <sub>GS(th)</sub>	1.0	-	2.5		V <sub>DS</sub> =V <sub>GS</sub> , I <sub>D</sub> =250μA
I <sub>GSS</sub>	-	-	±10	μA	V <sub>GS</sub> =±16V, V <sub>DS</sub> =0V
I <sub>DSS</sub>	-	-	1		V <sub>DS</sub> =60V, V <sub>GS</sub> =0V
	-	-	10		V <sub>DS</sub> =60V, V <sub>GS</sub> =0V, T <sub>j</sub> =55°C
R <sub>DS(ON)</sub> *	-	0.27	0.6	Ω	I <sub>D</sub> =700mA, V <sub>GS</sub> =10V
	-	0.71	1.5		I <sub>D</sub> =500mA, V <sub>GS</sub> =4.5V
G <sub>FS</sub>	300	756	-	mS	V <sub>DS</sub> =10V, I <sub>D</sub> =500mA
<b>Dynamic</b>					
C <sub>iss</sub>	-	52	78	pF	V <sub>DS</sub> =30V, V <sub>GS</sub> =0V, f=1MHz
C <sub>oss</sub>	-	16	24		
C <sub>rss</sub>	-	7.3	11		
*t <sub>r</sub>	-	6.6	9.9	ns	V <sub>DS</sub> =15V, I <sub>D</sub> =0.7A, V <sub>GS</sub> =10V, R <sub>G</sub> =6Ω
*t <sub>d</sub>	-	18.8	28.2		
*t <sub>stg</sub>	-	25.6	38.4		
*t <sub>f</sub>	-	15.8	23.7		
*Q <sub>g</sub>	-	1.4	2.1	nC	V <sub>DS</sub> =30V, I <sub>D</sub> =0.7A, V <sub>GS</sub> =10V
*Q <sub>gs</sub>	-	0.6	0.9		
*Q <sub>gd</sub>	-	0.6	0.9		

Body Diode					
*V <sub>SD</sub>	-	0.76	1.2	V	I <sub>S</sub> =0.1A
*trr	-	10.9	-	ns	I <sub>F</sub> =0.7A, dI <sub>F</sub> /dt=100A/μs
*Qrr	-	5.6	-	nC	

\*Pulse Test : Pulse Width ≤300μs, Duty Cycle ≤2%

### Recommended Soldering Footprint

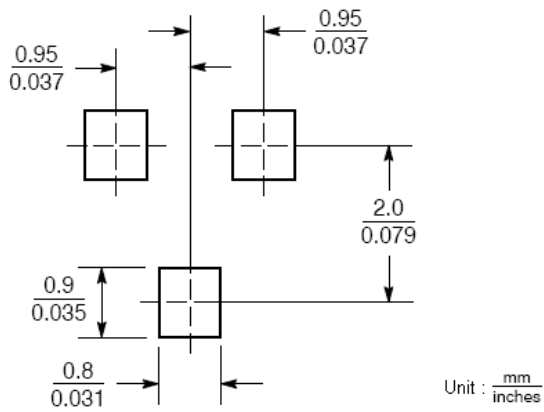



### Typical Characteristics

Typical Output Characteristics

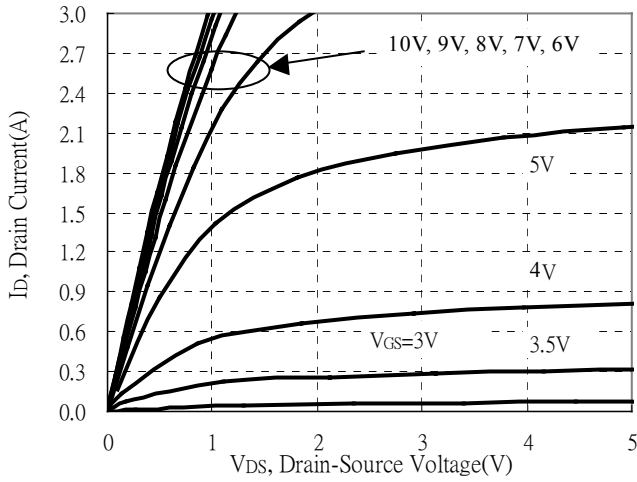

Brekdown Voltage vs Ambient Temperature

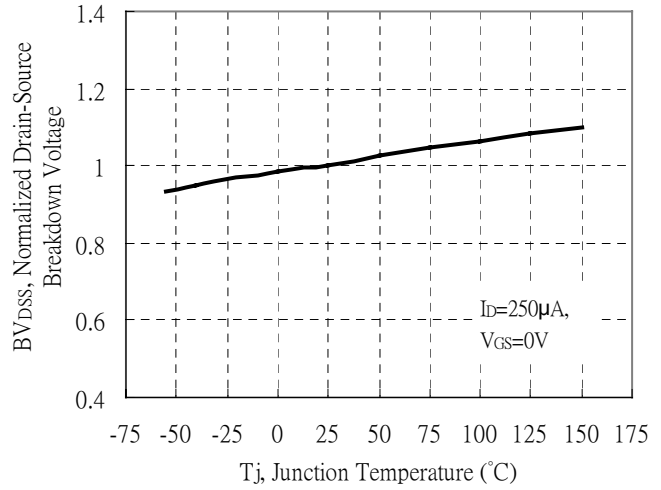

Static Drain-Source On-State resistance vs Drain Current

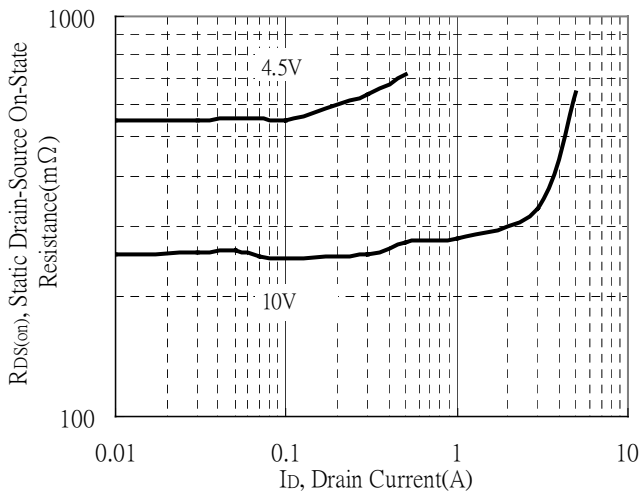

Reverse Drain Current vs Source-Drain Voltage

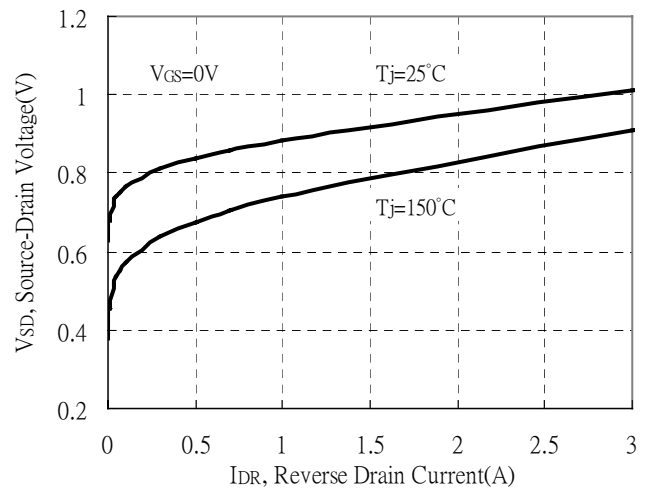

Static Drain-Source On-State Resistance vs Gate-Source Voltage

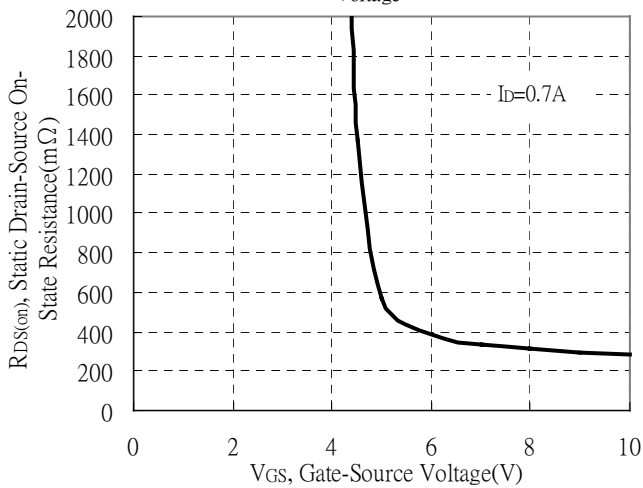

Drain-Source On-State Resistance vs Junction Temperature

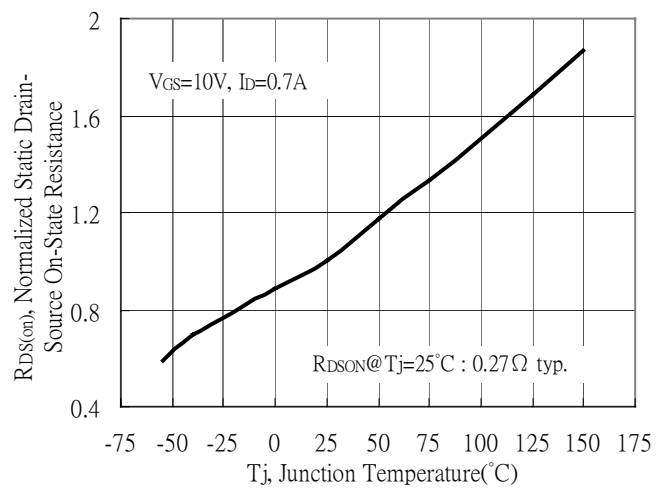

**Typical Characteristics(Cont.)**

Capacitance vs Drain-to-Source Voltage

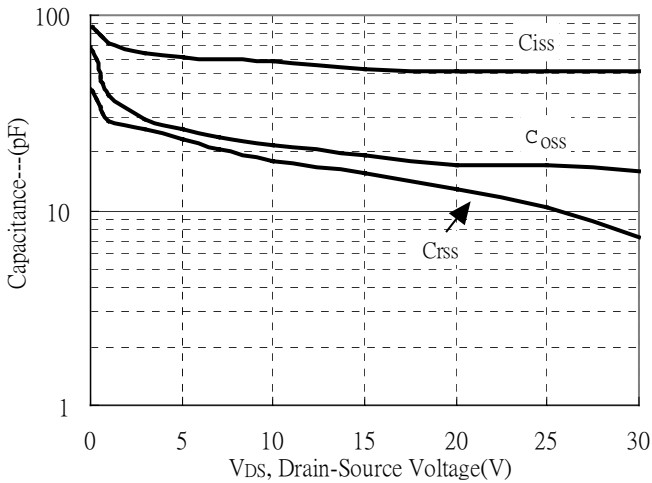

Threshold Voltage vs Junction Temperature

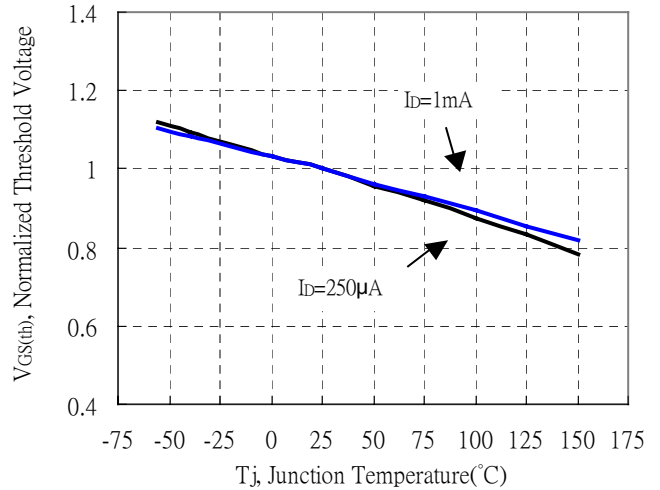

Forward Transfer Admittance vs Drain Current

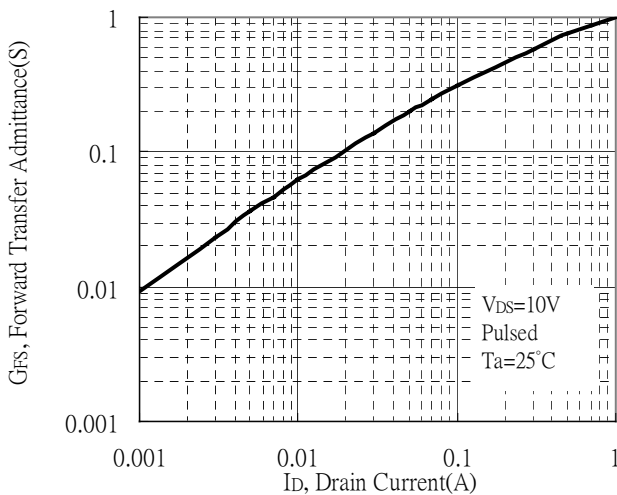

Gate Charge Characteristics

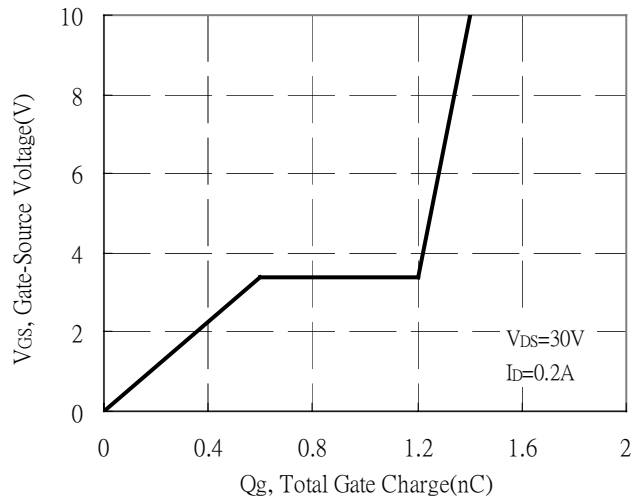

Maximum Safe Operating Area

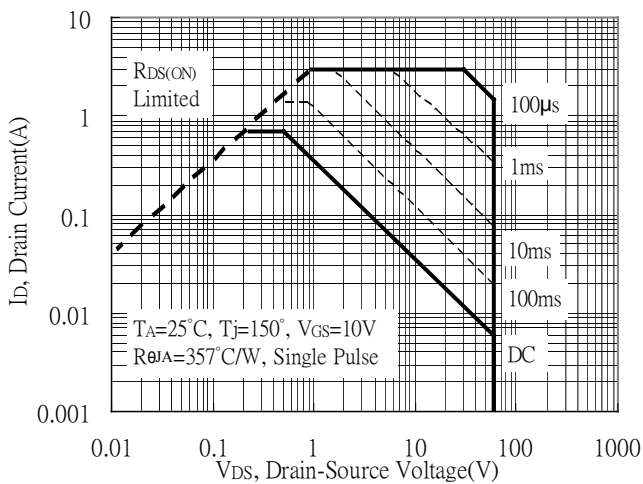

Maximum Drain Current vs Junction Temperature

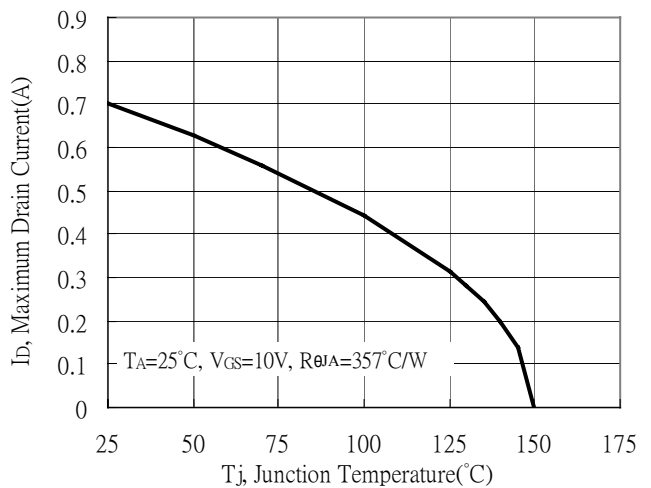



### Typical Characteristics(Cont.)

Typical Transfer Characteristics

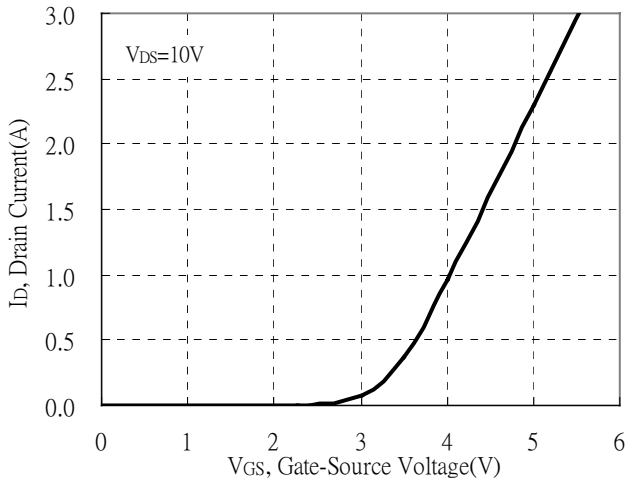

Single Pulse Power Rating, Junction to Ambient  
(Note on page 2)

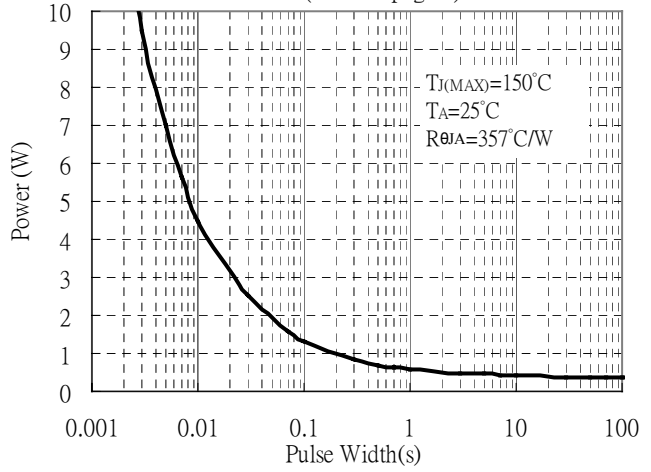

Transient Thermal Response Curves

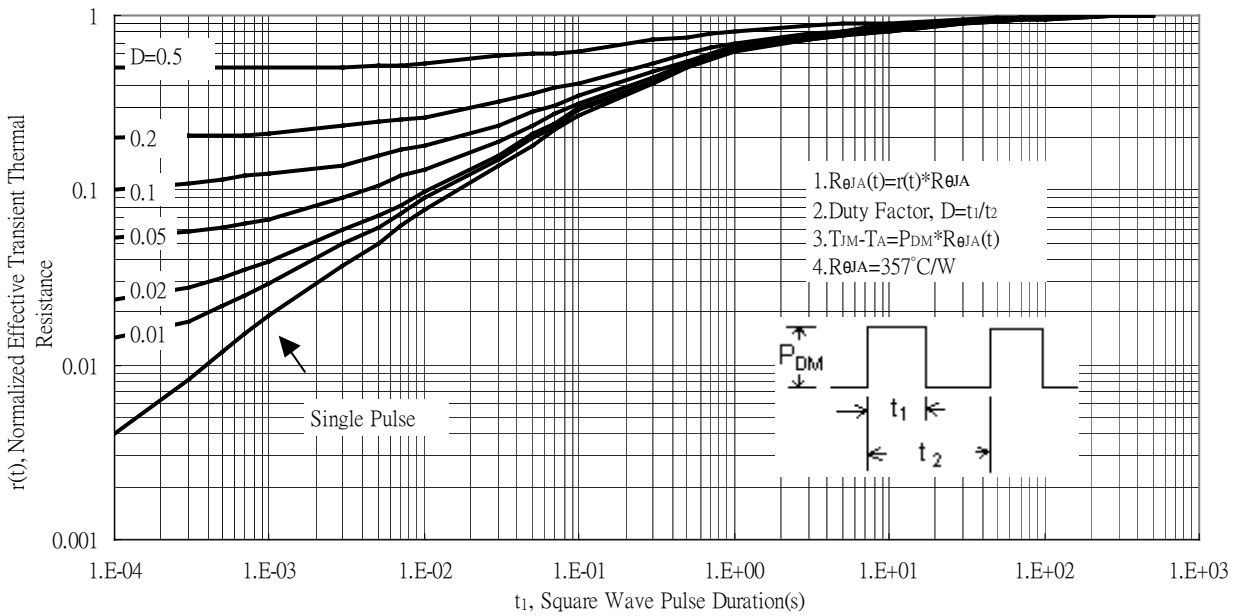

**Reel Dimension**

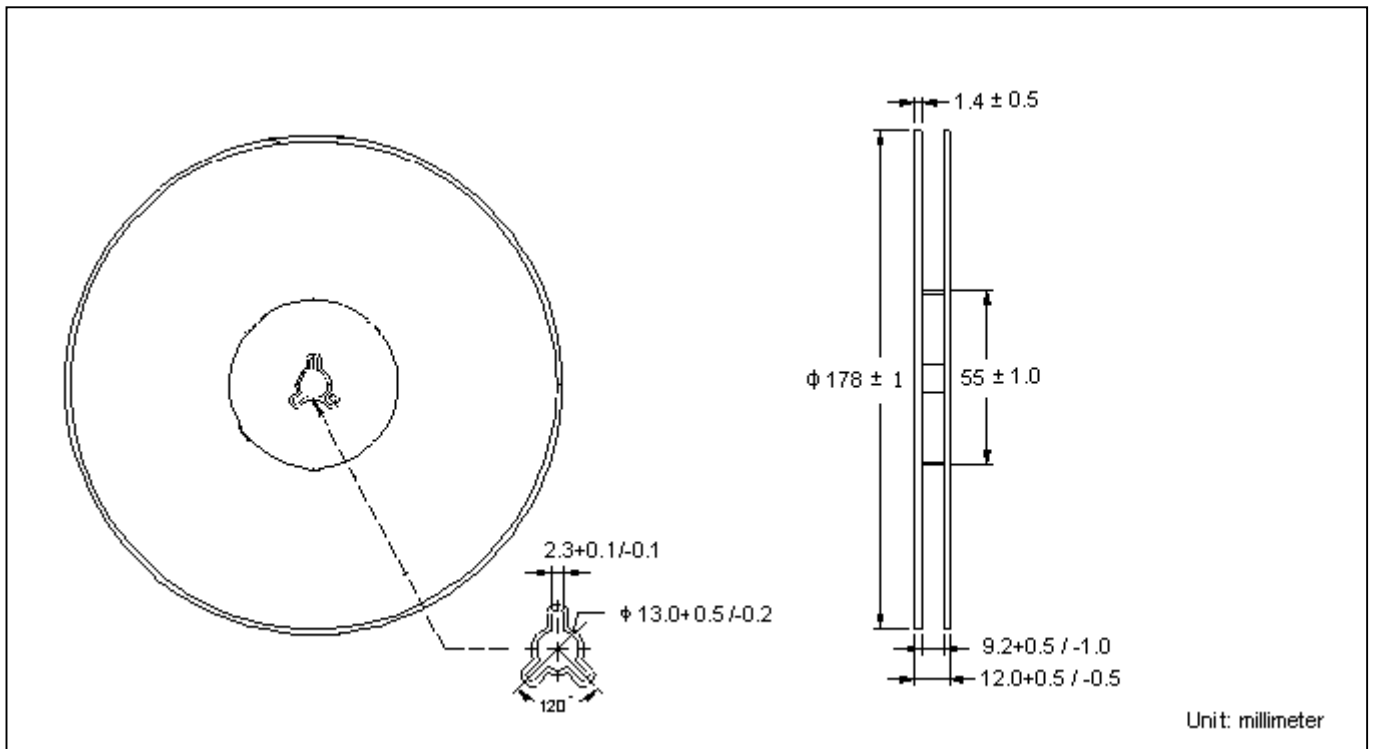

**Carrier Tape Dimension**

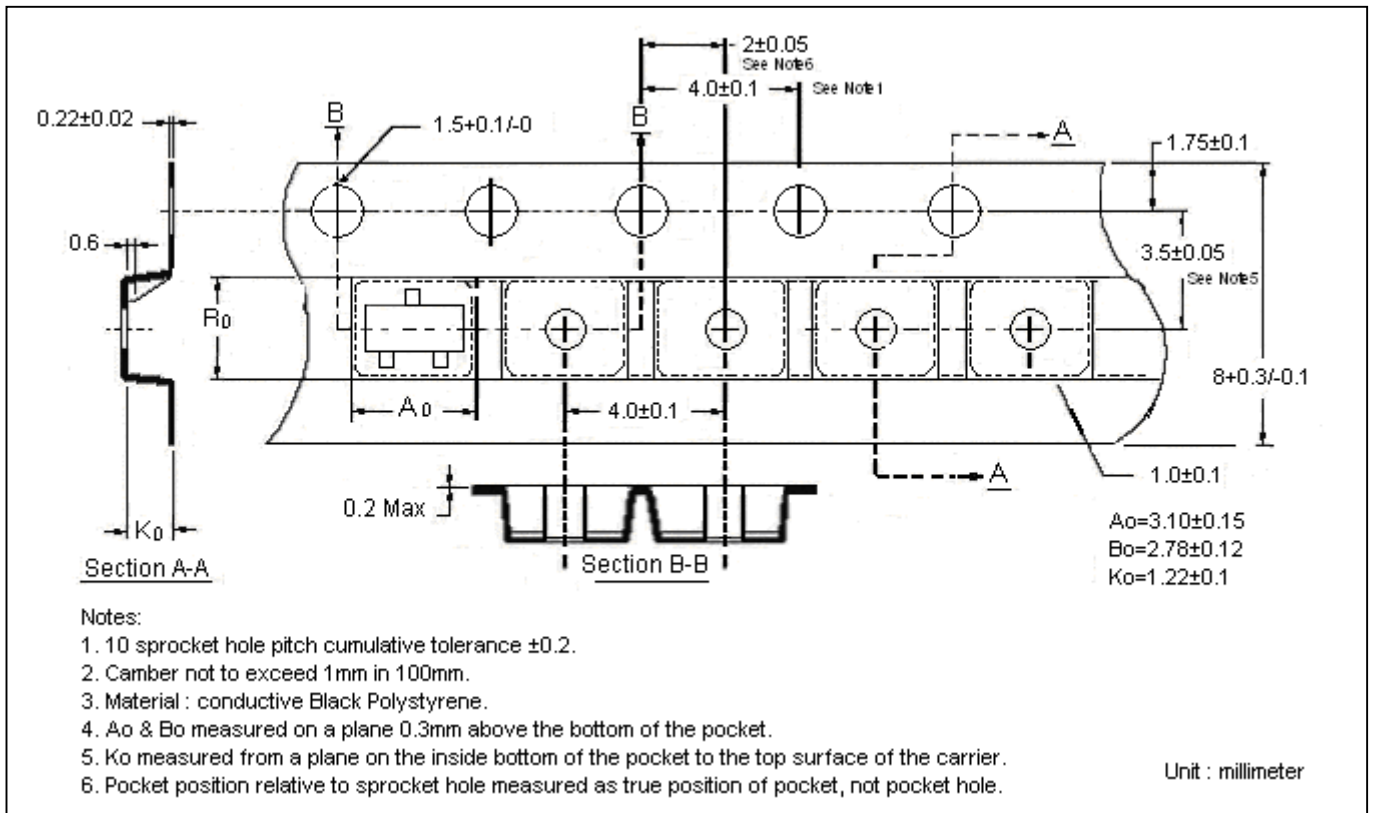

**Recommended wave soldering condition**

Product	Peak Temperature	Soldering Time
Pb-free devices	260 +0/-5 °C	5 +1/-1 seconds

**Recommended temperature profile for IR reflow**

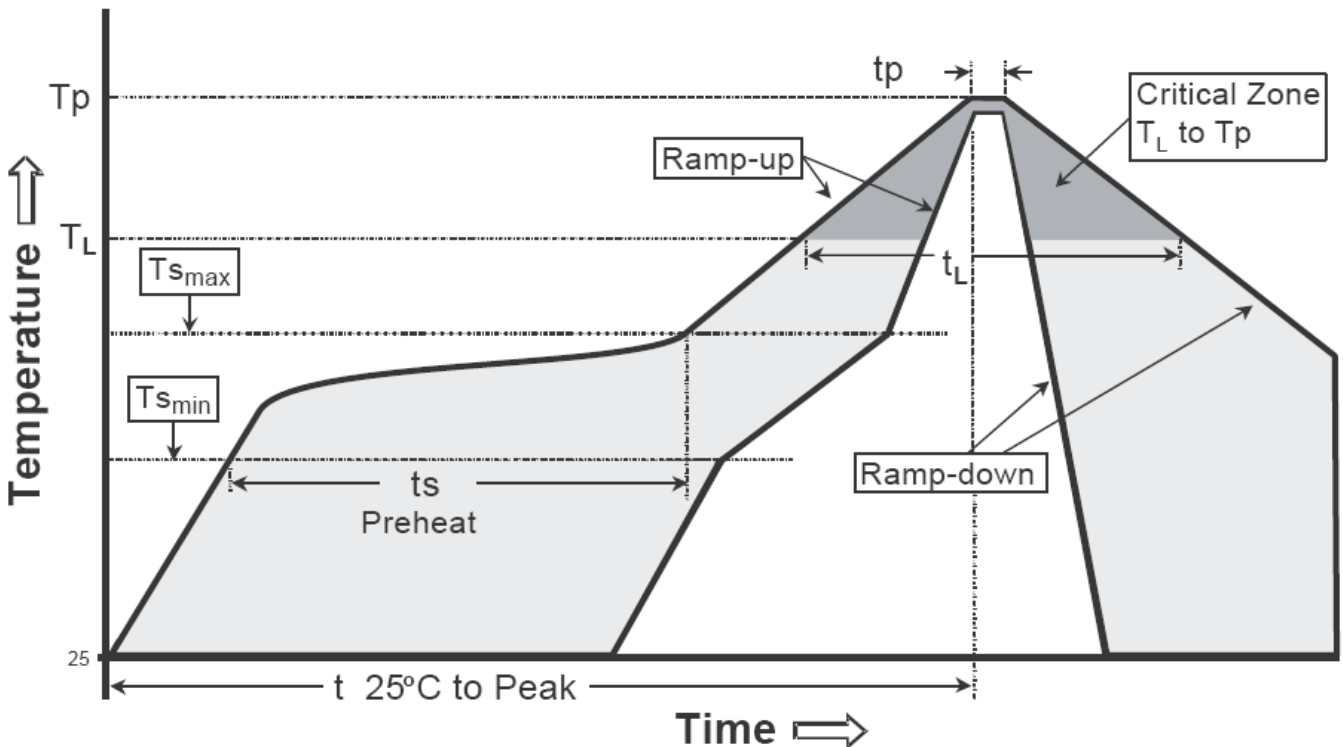

Profile feature	Sn-Pb eutectic Assembly	Pb-free Assembly
Average ramp-up rate (Tsmax to Tp)	3°C/second max.	3°C/second max.
Preheat		
-Temperature Min(Ts min)	100°C	150°C
-Temperature Max(Ts max)	150°C	200°C
-Time(ts min to ts max)	60-120 seconds	60-180 seconds
Time maintained above:		
-Temperature (Tl)	183°C	217°C
- Time (tl)	60-150 seconds	60-150 seconds
Peak Temperature(Tp)	240 +0/-5 °C	260 +0/-5 °C
Time within 5°C of actual peak temperature(tp)	10-30 seconds	20-40 seconds
Ramp down rate	6°C/second max.	6°C/second max.
Time 25 °C to peak temperature	6 minutes max.	8 minutes max.

Note : All temperatures refer to topside of the package, measured on the package body surface.



**SOT-23 Dimension**

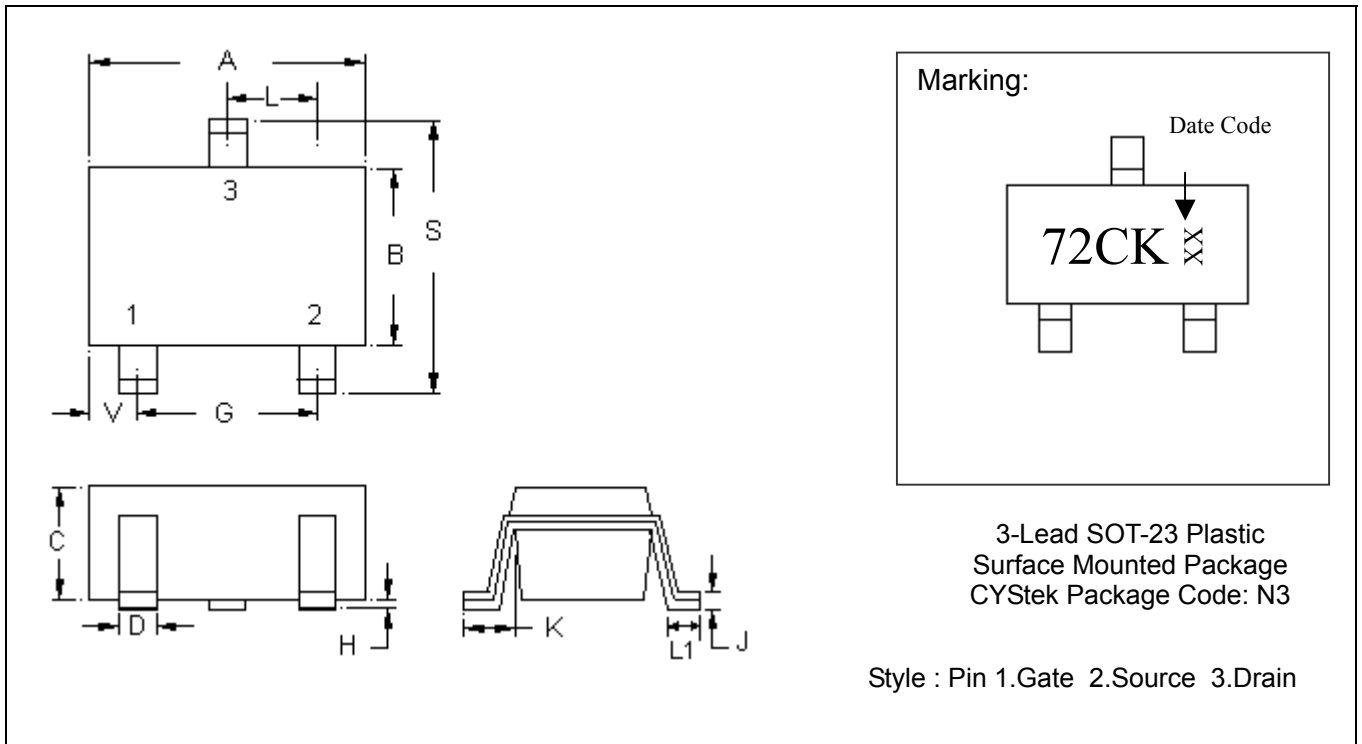

\*:Typical

DIM	Inches		Millimeters		DIM	Inches		Millimeters	
	Min.	Max.	Min.	Max.		Min.	Max.	Min.	Max.
A	0.1102	0.1204	2.80	3.04	J	0.0032	0.0079	0.08	0.20
B	0.0472	0.0669	1.20	1.70	K	0.0118	0.0266	0.30	0.67
C	0.0335	0.0512	0.89	1.30	L	0.0335	0.0453	0.85	1.15
D	0.0118	0.0197	0.30	0.50	S	0.0830	0.1161	2.10	2.95
G	0.0669	0.0910	1.70	2.30	V	0.0098	0.0256	0.25	0.65
H	0.0000	0.0040	0.00	0.10	L1	0.0118	0.0197	0.30	0.50

Notes : 1.Controlling dimension : millimeters.  
 2.Maximum lead thickness includes lead finish thickness, and minimum lead thickness is the minimum thickness of base material.  
 3.If there is any question with packing specification or packing method, please contact your local CYStek sales office.

**Material :**

- Lead : Pure tin plated.
- Mold Compound : Epoxy resin family, flammability solid burning class:UL94V-0.

**Important Notice:**

- All rights are reserved. Reproduction in whole or in part is prohibited without the prior written approval of CYStek.
- CYStek reserves the right to make changes to its products without notice.
- CYStek **semiconductor products are not warranted to be suitable for use in Life-Support Applications, or systems.**
- CYStek assumes no liability for any consequence of customer product design, infringement of patents, or application assistance.